

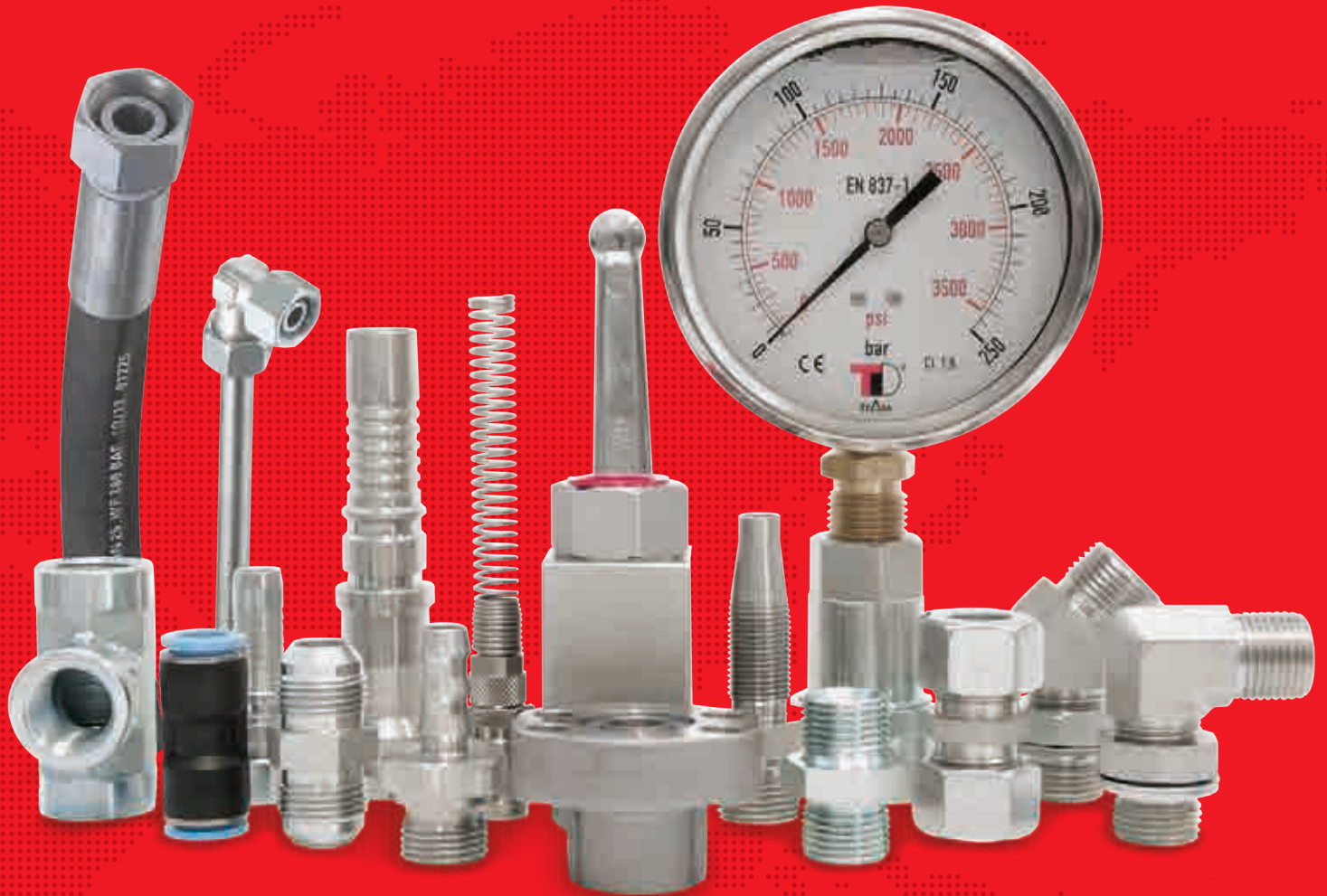

# SALINAS

CAUCHOS Y POLIURETANOS



Conducciones Hidráulicas y Neumáticas

2016

Hydraulic and Pneumatic Connectors  
Connectique Hydraulique et Pneumatique  
Conduzione Idrrauliche e Pneumatiche

# MEJORAMOS

## NUESTRA PLATAFORMA DIGITAL

*WE'RE UPDATING OUR WEBSITE TO SERVE YOU BETTER.*

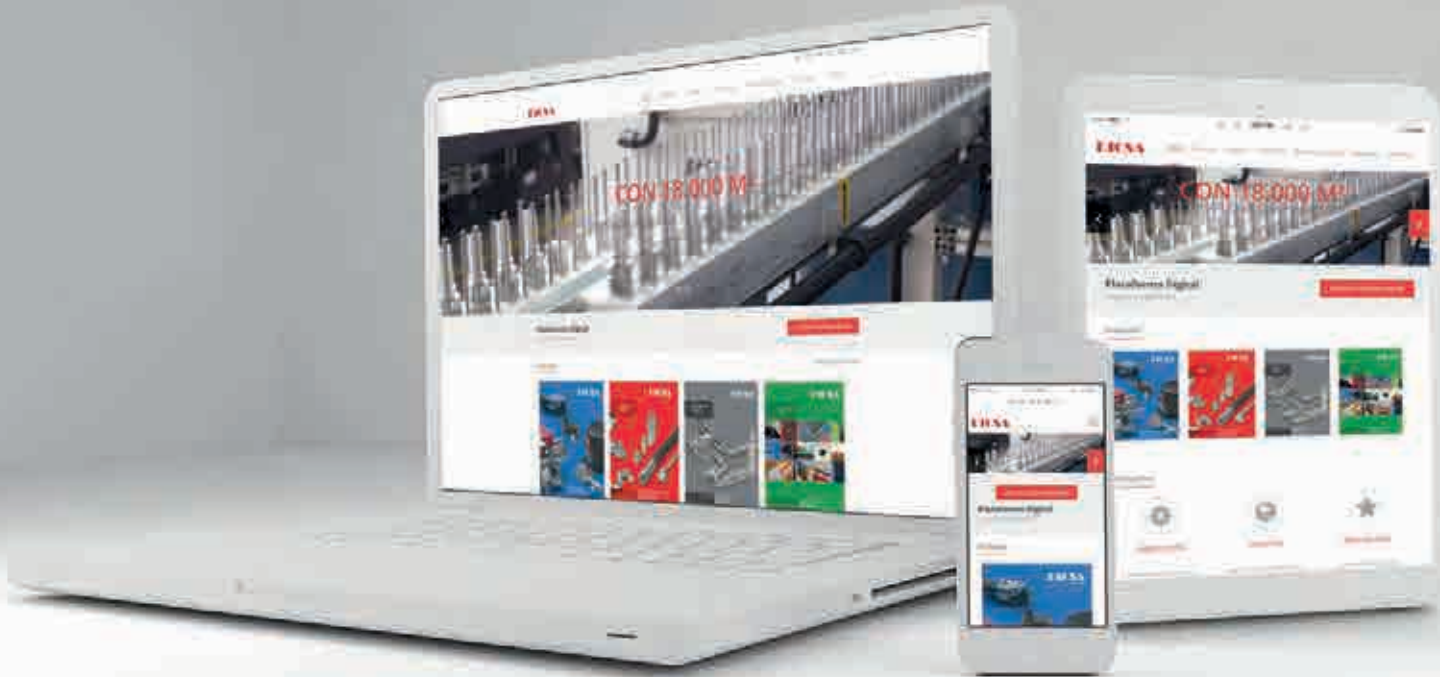

- ✓ Gestione usted mismo sus restos de pedido pendientes de servir.
  - ✓ Disponibilidad del producto según cantidad solicitada
  - ✓ Puede consultar sus pedidos en curso y ver su estado en tiempo real.
  - ✓ Gestione su pedido online y además puede ver y crear ofertas desde su área cliente.
  - ✓ Pedidos W-Express: En este tipo de pedidos garantizamos la salida del pedido en el día.
  - ✓ Seleccione su medio de transporte en función de precios, plazos,...
  - ✓ También podrá incorporar diferentes usuarios para gestionar el sistema y decidir el nivel de acceso al sistema de los mismos.
- ✓ Handle by yourself your backorders pending to be served.
  - ✓ Product availability according to quantity ordered.
  - ✓ Check order status: You can consult their orders online and in real time.
  - ✓ Clients can manage their orders online and see and create quotes in the Client Area.
  - ✓ W-Express Orders: With this type of order we guarantee same-day shipping.
  - ✓ Select means of transport according to price, delivery times, etc.
  - ✓ Create auxiliary users: Clients can also add different users to manage the system and can decide their level of access to the system.

## Flexibles hidráulicos

*Flexible connectors*  
Flexibles hydrauliques  
Flessibili idrauliche



## Flexibles Industriales

*Industrial Flexible Hoses & Fittings*  
Flexibles industriels  
Tubi flessibili e raccordi industriali



## Tubo rígido

*Pipe connectors*  
Connectique rigide  
Tubo rigido



## Accesorios

*Accessories*  
Accessoires  
Accessori



## Conducciones neumáticas

*Pneumatic connectors*  
Connectique pneumatique  
Condutture pneumatiche





**Mangueras**

*Hoses*  
*Tuyaux*  
*Tubi flessibili*

1

**Racores para tubería flexible**

*Flexible hose fittings*  
*Embouts à sertir*  
*Raccordi per tubi flessibili*

2

**Metrología**

*Flow measuring*  
*Test du circuit hydraulique*  
*Test per circuiti idraulici.*

3

**Máquinas tratamiento tubo flexible**

*Processing machine for flexible hoses*  
*Machines pour le montage des flexibles*  
*Macchine per l'assemblaggio di tubi flessibili*

4

# Mangueras

*Hoses*

Tuyaux

*Tubi flessibili*

## Mangueras hidráulicas TrΔle

*Hydraulic hoses TrΔle*

Tuyaux hydrauliques TrΔle

*Tubi idraulici TrΔle*

12

## Mangueras hidráulicas Triagle

*Hydraulic hoses Triagle*

Tuyaux hydrauliques Triagle

*Tubi idraulici Triagle*

16

## Mangueras PTFE

*PTFE hoses*

Tuyaux PTFE

*Tubi PTFE*

17

## Mangueras termoplásticas TrΔle

*Thermoplastic hoses TrΔle*

Tuyaux thermoplastiques TrΔle

*Tubi termoplastici TrΔle*

18

1

# Mangueras hidráulicas TrΔle

Hydraulic hoses TrΔle  
Tuyaux hydrauliques TrΔle  
Tubi idraulici TrΔle

Flexible hose fittings

Flow measuring

Processing machine  
for flexible hoses

## Mangueras hidráulicas TrΔle / TrΔle Hydraulic hoses / Tuyaux hydrauliques TrΔle / Tubi idraulici TrΔle

12



MSB21

ML7010

MB22

M2503

M7000

MB23

MS2230

MS3509



M2SC-NL

MS3511

MS15C

MS25C

## Manguera hidrolavadoras agua caliente TrΔle / TrΔle Hydrowashing hose for hot water / Tuyau lavage haute pression-TrΔle / Tubi per idropulitrici ad acqua calda TrΔle

14

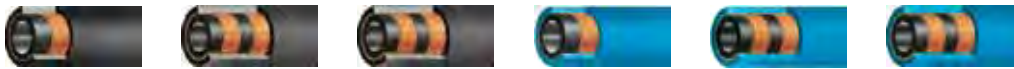

MSC011...N

MSC021...N

MSC021...G

MSC011...A

MSC021...A

MSC022...A

## Mangueras multiespiral TrΔle / TrΔle multi-spiral hoses / Tuyaux multi-spirales TrΔle / Tubi multi spirale TrΔle

15



MS4248/MS4290

M4612

MS4569

M4713

MS4815



# Mangueras hidráulicas Triagle

Hydraulic hoses Triagle  
Tuyaux hydrauliques Triagle  
Tubi idraulici Triagle

## ■ Manguera 1 y 2 mallas / 1 and 2 Braids hoses / Tuyau 1 et 2 tresses / Tubi a 1 e 2 trecce metalliche

16



ML2230

ML3511

## ■ Manguera hidrolavadoras agua caliente / Hydrowashing hose for hot water / Tuyau lavage haute pression / Tubi per idropulitrici ad acqua calda

16



MC020 G

MC021 A

## ■ Manguera multiespiral / Multi-spiral hoses / Tuyau multi-spirales / Multi-trecce metalliche

16



ML3601

ML4569

ML4248/ML4290

M4815

# Mangueras PTFE

PTFE hoses  
Tuyaux PTFE  
Tubi PTFE

Flexible hose fittings

## PTFE liso / Smooth PTFE / PTFE lisse / PTFE liscio

| 17



M2950

M2900

M29012

Flow measuring

## PTFE corrugado / Convolute PTFE / PTFE convoluté / PTFE corrugato

| 17



M2920

M2980

M2930

Processing machine  
for flexible hoses

# Mangueras termoplásticas TrΔle

*Thermoplastic hoses TrΔle*

*Tuyaux thermoplastiques TrΔle*

*Tubi termoplastici TrΔle*

## ■ Termoplásticas malla textil / *Thermoplastic textile braid* / Thermoplastique tresse textile / *Tubi termoplastici con maglia tessile*

18



MT070

MT080

MT071

MT010

MT270

MT280

MT081

MP1890

## ■ Termoplásticas malla metálica / *Thermoplastic metallic braid* / Thermoplastique tresse métallique / *Tubi termoplastici con maglia metallica*

19



MT090

MT099

MT095

MT290

MT299

MT700

MT096

## ■ Limpieza de alcantarillas / *Sewer jetting hose* / Tuyau hydrocurage / *Tubi per la pulizia di fognature*

20



MEC200

MEC210

MEC250

Z21200

MEC20/21/25

Flexible hose fittings

Flow measuring

Processing machine  
for flexible hoses

# Mangueras hidráulicas TrΔle

Hydraulic hoses TrΔle  
Tuyaux hydrauliques TrΔle  
Tubi idraulici TrΔle

## Manguera EN 854 R6 / SAE 100 R6

EN 854 R6 / SAE 100 R6 Hose

Tuyau EN 854 R6 / SAE 100 R6



Tubi EN 854 R6 / SAE 100 R6

DN	Ø INNER Ø INT.	Part nº Referencia	€
1/4"	6,3	MSB2104	3,69
5/16"	8,2	MSB2105	4,64
3/8"	9,8	MSB2106	5,60
1/2"	12,9	MSB2108	7,45
5/8"	16,2	MSB2110	9,12
3/4"	19,2	MSB2112	11,13
1"	25	MSB2116	14,82

## Manguera SAE 100 R4

SAE 100 R4 Hose

Tuyau SAE 100 R4



Tubi SAE 100 R4

DN	Ø INNER Ø INT.	Part nº Referencia	€
3/4"	19	ML701019	12,16
1"	25,4	ML701025	17,81
1"1/4	31,8	ML701032	22,84
1"1/2	38,1	ML701038	25,55
2"	50,8	ML701050	40,27
2"1/2	63,5	ML701063	44,53

## Manguera EN 854 2TE

EN 854 2TE Hose

Tuyau EN 854 2TE



Tubi EN 854 2TE

DN	Ø INNER Ø INT.	Part nº Referencia	€
1/4"	6,4	MB2204	6,81
5/16"	8	MB2205	7,12
3/8"	9,5	MB2206	7,59
1/2"	12,7	MB2208	8,67
5/8"	16	MB2210	10,53
3/4"	19	MB2212	12,39
1"	25,4	MB2216	16,26

## Manguera SAE 100 R5

SAE 100 R5 Hose

Tuyau SAE 100 R5



Tubi SAE 100 R5

DN	Ø INNER Ø INT.	Part nº Referencia	€
3/16"	4,8	M250304	4,64
1/4"	6,4	M250305	4,64
5/16"	7,9	M250306	6,09
13/32"	10,3	M250308	6,55
1/2"	12,7	M250310	7,81
5/8"	15,9	M250312	9,92
7/8"	22,2	M250316	21,59
1"1/8	28,6	M250320	26,10
1"3/8	34,9	M250324	26,45
1"13/16	46	M250332	30,09

## Manguera CarbuCORD 16 bar

CarbuCORD hose 16 bar

Tuyau CarbuCORD 16 bar



Tubi CarbuCORD 16 bar

Ø OUTER Ø EXT.	Ø INNER Ø INT.	Part nº Referencia	€
42	30	M70003041	30,28
44	32	M70003243	31,92
54	40	M70004054	43,58
65	50	M70005064	47,10

## Manguera EN 854 3TE

EN 854 3TE Hose

Tuyau EN 854 3TE



Tubi EN 854 3TE

DN	Ø INNER Ø INT.	Part nº Referencia	€
1/4"	6,4	MB2304	6,81
5/16"	8	MB2305	7,12
3/8"	9,5	MB2306	7,59
1/2"	12,7	MB2308	8,67
5/8"	16	MB2310	10,53
3/4"	19	MB2312	12,39
1"	25,4	MB2316	16,26

# Mangueras hidráulicas TrΔle

Hydraulic hoses TrΔle  
Tuyaux hydrauliques TrΔle  
Tubi idraulici TrΔle

## Manguera EN 853 1SN / SAE 100 R1AT

EN 853 1SN / SAE 100 R1AT Hose

Tuyau EN 853 1SN / SAE 100 R1AT



Tubi EN 853 1SN / SAE 100 R1AT

DN	Ø INNER Ø INT.	Part nº Referencia	€
3/16"	5	MS223003	4,34
1/4"	6,3	MS223004	4,25
5/16"	8,2	MS223005	5,58
3/8"	9,8	MS223006	6,00
1/2"	12,9	MS223008	7,15
5/8"	16,2	MS223010	9,08
3/4"	19,2	MS223012	11,18
1"	25,3	MS223016	15,65
1" 1/4"	32,2	MS223020	21,23
1" 1/2"	38,2	MS223024	24,21
2"	51,2	MS223032	31,30

## Manguera EN 853 2ST / SAE 100 R2A

EN 853 2ST / SAE 100 R2A Hose

Tuyau EN 853 2ST / SAE 100 R2A



Tubi EN 853 2ST / SAE 100 R2A

DN	Ø INNER Ø INT.	Part nº Referencia	€
1/4"	6,3	MS350904	5,85
5/16"	8,2	MS350905	7,68
3/8"	9,8	MS350906	8,56
1/2"	12,9	MS350908	10,81
5/8"	16,2	MS350910	13,44
3/4"	19,2	MS350912	15,62
1"	25,3	MS350916	21,45
1" 1/4"	32,2	MS350920	27,99
1" 1/2"	38,5	MS350924	33,08
2"	51,2	MS350932	44,53

## Manguera EN 857 2SC NL

EN 857 2SC Hose NL

Tuyau EN 857 2SC NL



Tubi 2SC/EN857 NL

DN	Ø INNER Ø INT.	Part nº Referencia	€
1/4"	6,5	M2SC04	5,76
3/8"	9,7	M2SC06	7,56
1/2"	12,9	M2SC08	8,99
3/4"	19,2	M2SC12	13,57
1"	25,7	M2SC16	19,07

## Manguera EN 853 2SN / SAE 100 R2AT

EN 853 2SN / SAE 100 R2AT Hose

Tuyau EN 853 2SN / SAE 100 R2AT



Tubi EN 853 2SN / SAE 100 R2AT

DN	Ø INNER Ø INT.	Part nº Referencia	€
1/4"	6,3	MS351104	5,76
5/16"	8,2	MS351105	7,16
3/8"	9,8	MS351106	7,56
1/2"	12,9	MS351108	9,07
5/8"	16,2	MS351110	11,49
3/4"	19,2	MS351112	13,70
1"	25,3	MS351116	19,07
1" 1/4"	32,2	MS351120	27,05
1" 1/2"	38,2	MS351124	31,63
2"	51	MS351132	38,13

## Manguera EN 857 1SC

EN 857 1SC Hose

Tuyau EN 857 1SC



Tubi 1SC/EN857

DN	Ø INNER Ø INT.	Part nº Referencia	€
1/4"	6,5	MS1SC04	4,25
5/16"	8,1	MS1SC05	5,58
3/8"	9,7	MS1SC06	6,00
1/2"	12,9	MS1SC08	7,07
5/8"	16,1	MS1SC10	9,08
3/4"	19,2	MS1SC12	11,07
1"	25,7	MS1SC16	15,65

## Manguera EN 857 2SC

EN 857 2SC Hose

Tuyau EN 857 2SC



Tubi 2SC/EN857

DN	Ø INNER Ø INT.	Part nº Referencia	€
1/4"	6,5	MS2SC04	5,76
5/16"	8,1	MS2SC05	7,16
3/8"	9,7	MS2SC06	7,56
1/2"	12,9	MS2SC08	8,99
5/8"	16,1	MS2SC10	11,49
3/4"	19,2	MS2SC12	13,57
1"	25,7	MS2SC16	19,07

# Mangueras hidráulicas TrΔle

Hydraulic hoses TrΔle  
Tuyaux hydrauliques TrΔle  
Tubi idraulici TrΔle

## Superservicio agua caliente 1SC negra

Hot water superservice 1SC black

Superservice eau chaude 1SC noir

Superservice acqua calda 1SC nero



DN	Ø INNER Ø INT.	Part n° Referencia	€
1/4"	6,5	MSC0114N	5,11
5/16"	8,1	MSC0115N	6,08
3/8"	9,7	MSC0116N	6,80
1/2"	12,9	MSC0118N	8,73

## Superservicio agua caliente 2SC negra

Hot water superservice 2SC black

Superservice eau chaude 2SC noir

Superservice acqua calda 2SC nero



DN	Ø INNER Ø INT.	Part n° Referencia	€
1/4"	6,5	MSC0214N	5,93
5/16"	8,1	MSC0215N	7,68
3/8"	9,7	MSC0216N	8,78
1/2"	12,9	MSC0218N	11,21

## Superservicio agua caliente 2SN gris

Hot water superservice 2SN grey

Superservice eau chaude 2SN gris

Superservice acqua calda 2SN grigio



DN	Ø INNER Ø INT.	Part n° Referencia	€
5/16"	8,1	MSC0215G	8,25

## Superservicio agua caliente 1SC azul

Hot water superservice 1SC blue

Superservice eau chaude 1SC bleu

Superservice acqua calda 1SC azzurro



DN	Ø INNER Ø INT.	Part n° Referencia	€
1/4"	6,5	MSC0114A	5,35
5/16"	8,1	MSC0115A	6,39
3/8"	9,7	MSC0116A	7,15
1/2"	12,9	MSC0118A	9,17

## Superservicio agua caliente 2SC azul

Hot water superservice 2SC blue

Superservice eau chaude 2SC bleu

Superservice acqua calda 2SC azzurro



DN	Ø INNER Ø INT.	Part n° Referencia	€
1/4"	6,5	MSC0214A	6,01
5/16"	8,1	MSC0215A	7,89
3/8"	9,7	MSC0216A	9,29
1/2"	12,9	MSC0218A	11,77

## Superservicio agua caliente 2ST azul

Hot water superservice 2ST blue

Superservice eau chaude 2ST bleu

Superservice acqua calda 2ST azzurro



DN	Ø INNER Ø INT.	Part n° Referencia	€
5/16"	8,1	MSC0225A	8,22
3/8"	9,8	MSC0226A	9,18

# Mangueras hidráulicas TrΔle

Hydraulic hoses TrΔle  
Tuyaux hydrauliques TrΔle  
Tubi idraulici TrΔle

## Manguera EN 856 4SP / SAE 100 R9R-R10

EN 856 4SP / SAE 100 R9R-R10 Hose

Tuyau EN 856 4SP / SAE 100 R9R-R10

Tubi EN 856 4SP / SAE 100 R9R-R10



DN	Ø INNER Ø INT.	Part nº Referencia	€
1/4"	6,4	MS429004	20,08
3/8"	10	MS429006	20,08
1/2"	13	MS429008	20,39
5/8"	16	MS429010	26,36
3/4"	19	MS429012	27,53
1"	25,5	MS429016	35,10
1"1/4	32,2	MS424820	52,79
1"1/2	38,1	MS424824	63,59
2"	51,2	MS424832	73,89

## Manguera EN 856 R12 / SAE 100 R12

EN 856 R12 / SAE 100 R12 Hose

Tuyau EN 856 R12 / SAE 100 R12

Tubi EN 856 R12 / SAE 100 R12



DN	Ø INNER Ø INT.	Part nº Referencia	€
3/8"	9,5	M461206	27,21
1/2"	12,7	M461208	21,76
5/8"	15,9	M461210	25,15
3/4"	19	M461212	29,12
1"	25,4	M461216	38,90
1"1/4	31,8	M461220	50,78
1"1/2	38	M461224	60,92

## Manguera EN 856 4SH

EN 856 4SH Hose

Tuyau EN 856 4SH

Tubi EN 856 4SH



DN	Ø INNER Ø INT.	Part nº Referencia	€
3/4"	19	MS456912	29,75
1"	25,2	MS456916	39,48
1"1/4	32,2	MS456920	56,83
1"1/2	38,5	MS456924	68,45
2"	51,2	MS456932	79,54

## Manguera EN 856 R13 / SAE 100 R13

EN 856 R13 / SAE 100 R13 Hose

Tuyau EN 856 R13 / SAE 100 R13

Tubi EN 856 R13 / SAE 100 R13



DN	Ø INNER Ø INT.	Part nº Referencia	€
3/4"	19	M471312	38,84
1"	25,4	M471316	51,89
1"1/4	31,8	M471320	79,49
1"1/2	38,1	M471324	94,85
2"	50,8	M471332	134,61

## Manguera SAE 100 R15

SAE 100 R15 Hose

Tuyau SAE 100 R15

Tubi SAE 100 R15



DN	Ø INNER Ø INT.	Part nº Referencia	€
1"	25,7	MS481516	41,45
1"1/4	32,2	MS481520	85,81
1"1/2	38,5	MS481524	99,53

Flexible hose fittings

Flow measuring

Processing machine  
for flexible hoses

# Mangueras hidráulicas Triagle

Hydraulic hoses Triagle  
Tuyaux hydrauliques Triagle  
Tubi idraulici Triagle

Flexible hose fittings

Flow measuring

Processing machine  
for flexible hoses

## Manguera EN 853 1SN / SAE 100 R1AT

EN 853 1SN / SAE 100 R1AT Hose

Tuyau EN 853 1SN / SAE 100 R1AT



Tubi EN 853 1SN / SAE 100 R1AT

DN	Ø INNER Ø INT.	Part nº Referencia	€
3/16"	4,8	ML223003	6,93
1/4"	6,7	ML223004	5,46
5/16"	8	ML223005	5,64
3/8"	9,85	ML223006	6,86
1/2"	12,7	ML223008	8,31
5/8"	16	ML223010	10,86
3/4"	19	ML223012	12,20
1"	25,4	ML223016	17,05
1"1/4	31,8	ML223020	24,40
1"1/2	38,1	ML223024	32,65
2"	50,2	ML223032	42,30

## Manguera EN 853 2SN / SAE 100 R2AT

EN 853 2SN / SAE 100 R2AT Hose

Tuyau EN 853 2SN / SAE 100 R2AT



Tubi EN 853 2SN / SAE 100 R2AT

DN	Ø INNER Ø INT.	Part nº Referencia	€
3/16"	4,8	ML351103	9,32
1/4"	6,4	ML351104	7,40
5/16"	8	ML351105	8,01
3/8"	9,5	ML351106	8,62
1/2"	12,7	ML351108	10,07
5/8"	16	ML351110	13,78
3/4"	19	ML351112	15,84
1"	25,4	ML351116	23,31
1"1/4	31,8	ML351120	36,35
1"1/2	38,1	ML351124	43,52
2"	50,8	ML351132	55,29

## Superservicio agua caliente 2 mallas gris 400 bar

Hot water superservice 2 grey braids 400 bar

Superservice eau chaude 2 tresses gris 400 bar

Superservice acqua calda a 2 maglie grigio 400 bar



DN	Ø INNER Ø INT.	Part nº Referencia	€
5/16"	8,3	MC0205G	7,89
3/8"	9,9	MC0206G	9,29

## Superservicio agua caliente 2 mallas azul 400 bar

Hot water superservice 2 blue braids 400 bar

Superservice eau chaude 2 tresses bleu 400 bar

Superservice acqua calda a 2 maglie azzurro 400 bar



DN	Ø INNER Ø INT.	Part nº Referencia	€
5/16"	8,3	MC0215A	7,95
3/8"	9,9	MC0216A	9,29

## Manguera hidráulica 3 mallas

3 Braids hoses

Tuyau 3 tresses

Tubi 3 trecce



DN	Ø INNER Ø INT.	Part nº Referencia	€
1/2"	13	ML36010800	18,45
5/8"	16,4	ML36011000	22,70
3/4"	19,5	ML36011200	28,28
1"	26	ML36011600	43,70

Precios a consultar / On request / À consulter / Su richiesta

## Manguera EN 856 4SH

EN 856 4SH Hose

Tuyau EN 856 4SH

Tubi EN 856 4SH



DN	Ø INNER Ø INT.	Part nº Referencia	€
3/4"	19	ML456912	34,11
1"	25,4	ML456916	41,27
1"1/4	32	ML456920	60,81
1"1/2	38	ML456924	76,65
2"	50,8	ML456932	109,97

## Manguera EN 856 4SP / SAE 100 R9R-R10

EN 856 4SP / SAE 100 R9R-R10 Hose

Tuyau EN 856 4SP / SAE 100 R9R-R10

Tubi EN 856 4SP / SAE 100 R9R-R10



DN	Ø INNER Ø INT.	Part nº Referencia	€
3/8"	9,5	ML429006	22,15
1/2"	12,7	ML429008	20,64
5/8"	16	ML429010	26,95
3/4"	19	ML429012	31,26
1"	25,4	ML429016	40,00
1"1/4	31,8	ML424820	59,90
1"1/2	38,1	ML424824	72,83
2"	50,8	ML424832	104,45

## Manguera SAE 100 R15 / SAE J517 R15

SAE 100 R15 / SAE J517 R15 Hose

Tuyau SAE 100 R15 / SAE J517 R15

Tubi SAE 100 R15 / SAE J517 R15



DN	Ø INNER Ø INT.	Part nº Referencia	€
1"	25,4	M481516	54,38
1"1/4	31,8	M481520	114,17
1"1/2	38,1	M481524	142,67



# Mangueras PTFE

PTFE hoses  
Tuyaux PTFE  
Tubi PTFE

## PTFE sin malla

PTFE without braid

PTFE sans tresse

PTFE senza maglia

PIPE TUBO	LENGTH (M) LONGITUD (M)	Part n° Referencia	€/rollo
2x4	25	M2950204	83,23
4x6	25	M2950406	122,25
6x8	25	M2950608	176,87
2x4	100	M2950204-100	332,93
4x6	100	M2950406-100	488,99
6x8	100	M2950608-100	707,47

## PTFE Liso 1 malla

FHL (light) / Smooth PTFE

FHL (série légère)

FHL (serie leggera)

DN	Ø INNER Ø INT.	Part n° Referencia	€
1/8"	3,2	M290003	10,20
3/16"	4,8	M290005	10,94
1/4"	6,35	M290006	11,21
5/16"	7,9	M290008	14,59
3/8"	9,5	M290009	14,92
1/2"	12,7	M290013	20,49
5/8"	15,9	M290016	29,04
3/4"	19	M290020	36,00
1"	25,4	M290025	58,28

## PTFE corrugado 1 malla

Convuluted PTFE

PTFE convoluté

PTFE corrugato

DN	Ø INNER MIN. Ø INT. MIN.	Ø INNER MAX. Ø INT. MAX.	Ø OUT MIN. Ø EXT. MIN.	Ø OUT MAX. Ø EXT. MÁX.	Part n° Referencia	€
1/4"	5,95	6,45	9,14	9,65	M292006	26,15
3/8"	10	11	14,7	16,2	M292009	34,54
1/2"	13	14	18	19,7	M292013	37,41
5/8"	16	17	21,5	23	M292016	44,75
3/4"	19,5	20,7	25	27,5	M292020	54,19
1"	25,4	26,8	32	34,3	M292025	75,61
1" 1/4	31,5	33	38,5	41	M292032	119,34
1" 1/2	38	40	44,5	48	M292038	156,33
2"	50,5	52,7	57	62	M292050	205,41

## PTFE Liso grueso 2 mallas

FHM 2 Braids

FHM 2 tresses

FHM doppia maglia

DN	Ø INNER Ø INT.	Part n° Referencia	€
1/4"	6,35	M2901206	19,82
5/16"	7,9	M2901208	23,47
3/8"	9,5	M2901209	26,92
1/2"	12,7	M2901213	36,47
5/8"	15,9	M2901216	49,66
3/4"	19	M2901219	58,34
1"	25,4	M2901225	79,56

## PTFE corrugado con fibra de vidrio

Convuluted PTFE with fiberglass

PTFE convoluté avec fibre de verre

PTFE con fibra di vetro

DN	Ø INNER Ø INT.	Part n° Referencia	€
3/8"	9,65	M298009	68,80
1/2"	13,45	M298013	92,21
3/4"	19,85	M298020	121,69
1"	25,88	M298025	162,03
1" 1/4	32,30	M298032	192,06

## PTFE corrugado 1 malla anti-estático

Convuluted PTFE anti-static

PTFE convoluté anti-statique

PTFE corrugato anti-statico

DN	Ø INNER MIN. Ø INT. MIN.	Ø INNER MAX. Ø INT. MAX.	Ø OUT MIN. Ø EXT. MIN.	Ø OUT MAX. Ø EXT. MÁX.	Part n° Referencia	€
3/8"	10	11	14,7	16,2	M293009	46,61
1/2"	13	14	18	19,7	M293013	52,78
3/4"	19,5	20,7	25	27,5	M293020	71,80
1"	25,4	26,8	32	34,3	M293025	104,09

# Mangueras termoplásticas TrΔle

Thermoplastic hoses TrΔle

Tuyaux thermoplastiques TrΔle

Tubi termoplastici TrΔle

## SAE 100 R7

SAE 100 R7

SAE 100 R7



SAE 100 R7

DN	Ø INNER Ø INT.	Part nº Referencia	€
1/8"	4	MT07002	4,06
3/16"	5	MT07003	4,50
1/4"	6,5	MT07004	5,50
5/16"	8,1	MT07005	7,81
3/8"	9,7	MT07006	8,43
1/2"	13	MT07008	12,12
5/8"	16,3	MT07010	17,87
3/4"	19,5	MT07012	20,18
1"	25,9	MT07016	30,30

## SAE 100 R8

SAE 100 R8

SAE 100 R8



SAE 100 R8

DN	Ø INNER Ø INT.	Part nº Referencia	€
3/16"	5	MT08003	8,43
1/4"	6,5	MT08004	14,12
5/16"	8,1	MT08005	15,49
3/8"	9,7	MT08006	20,30
1/2"	13	MT08008	26,86
5/8"	16,3	MT08010	33,61
3/4"	19,5	MT08012	42,98
1"	25,9	MT08016	61,79

## SAE 100 R7 no conductiva

SAE 100 R7 non-conductive

SAE 100 R7 non-conducteur



SAE 100 R7 non conduttivo

DN	Ø INNER Ø INT.	Part nº Referencia	€
3/16"	5,00	MT07103	4,62
1/4"	6,50	MT07104	5,62
5/16"	8,10	MT07105	8,00
3/8"	9,70	MT07106	8,68
1/2"	13,00	MT07108	12,50
5/8"	16,30	MT07110	18,43
3/4"	19,50	MT07112	20,74
1"	25,90	MT07116	31,24

## MICRO-HOSE

MICRO-HOSE

MICRO-HOSE



MICRO-HOSE

Ø INNER Ø INT.	Part nº Referencia	€
2	MT01002	3,00

## SAE 100 R7 Bitubo

SAE 100 R7 Twin

SAE 100 R7 Jumelé



SAE 100 R7 Binato

DN	Ø INNER Ø INT.	Part nº Referencia	€
3/16"	5	MT27003	10,37
1/4"	6,5	MT27004	12,37
5/16"	8,1	MT27005	16,93
3/8"	9,7	MT27006	18,18
1/2"	13	MT27008	25,55

## SAE 100 R8 Bitubo

SAE 100 R8 Twin

SAE 100 R8 Jumelé



SAE 100 R8 Binato

DN	Ø INNER Ø INT.	Part nº Referencia	€
1/4"	6,5	MT28004	29,55
5/16"	8,1	MT28005	32,24
3/8"	9,7	MT28006	41,92
1/2"	13	MT28008	55,10

## SAE 100 R8 no conductiva

SAE 100 R8 non-conductive

SAE 100 R8 non-conducteur



SAE 100 R8 non conduttivo

DN	Ø INNER Ø INT.	Part nº Referencia	€
1/4"	6,5	MT08104	14,49
5/16"	8,1	MT08105	15,93
3/8"	9,7	MT08106	20,87
1/2"	13	MT08108	27,68
5/8"	16,3	MT08110	34,61
3/4"	19,5	MT08112	44,30
1"	25,9	MT08116	63,66

## Termoplásticas Push-on

Thermoplastic Push-on

Thermoplastique Push-on



Tubi termoplastici Push-on

DN	Ø INNER Ø INT.	Part nº Referencia	€
1/4"	6,3	MP189004	6,50
3/8"	9,5	MP189006	8,75
1/2"	12,7	MP189008	14,18
5/8"	16	MP189010	19,06
3/4"	19	MP189012	23,05

# Mangueras termoplásticas TrΔle

Thermoplastic hoses TrΔle

Tuyaux thermoplastiques TrΔle

Tubi termoplastici TrΔle

## Elastómero malla metálica

*Metallic braid elastomer*

Elastomère 1 tresse métallique



*Treccia Metallica*

DN	Ø INNER Ø INT.	Part nº Referencia	€
3/16"	5,00	MT09003	6,75
1/4"	6,50	MT09004	7,75
5/16"	8,10	MT09005	8,75
3/8"	9,80	MT09006	10,06
1/2"	13,00	MT09008	12,75
5/8"	16,30	MT09010	16,93
3/4"	19,50	MT09012	19,06
1"	25,80	MT09016	26,86

## Elastómero malla metálica pintura

*Paint metallic braid elastomer*

Elastomère 1 tresse métallique peinte



*Treccia Metallica per vernici*

DN	Ø INNER Ø INT.	Part nº Referencia	€
3/16"	5	MT099003	6,94
1/4"	6,5	MT099004	8,00
3/8"	9,8	MT099006	10,37
1/2"	13	MT099008	13,18
3/4"	19,5	MT099012	19,62

## Isobárica baja temperatura

*Isobaric low temperature*

Isobarique basse température



*Isobarica bassa temperatura*

DN	Ø INNER Ø INT.	Part nº Referencia	€
1/4"	6,40	MT095004	13,12
3/8"	9,70	MT095006	25,37
1/2"	13	MT095008	33,61

## Elastómero malla metálica bitubo

*Metallic braid elastomer twin*

Elastomère 1 tresse métallique jumelé



*Treccia Metallica Binato*

DN	Ø INNER Ø INT.	Part nº Referencia	€
3/16"	5,00	MT29003	14,81
1/4"	6,50	MT29004	16,81
5/16"	8,10	MT29005	18,81
3/8"	9,80	MT29006	21,49
1/2"	13,00	MT29008	26,86

## Elastómero doble malla metálica pintura

*Paint metallic braid 2 tubes elastomer*

Elastomère 2 tresses métalliques peinture



*Doppia Treccia Metallica per vernici*

DN	Ø INNER Ø INT.	Part nº Referencia	€
1/4"	6,4	MT299004	13,31
3/8"	9,8	MT299006	19,43
1/2"	13	MT299008	22,49

## Manguera termoplástica 700 bar

*Thermoplastic hose 700 bar*

Tuyau thermoplastique haute pression 700 bar



*Tubo termoplastico 700 bar*

DN	Ø INNER Ø INT.	Part nº Referencia	€
1/4"	6,6	MT70004	19,74
3/8"	9,8	MT70006	46,54

## Termoplástica malla metálica para productos químicos

*Metallic braid elastomer for chemical products*

Elastomère tresse métallique pour produits chimiques



*Treccia Metallica per sostanze chimiche*

DN	Ø INNER Ø INT.	Part nº Referencia	€
1/4"	6,40	MT096004	14,62
3/8"	9,80	MT096006	21,37
1/2"	13,00	MT096008	24,74
5/8"	16,30	MT096010	35,30
3/4"	19,50	MT096012	39,98
1"	25,80	MT096016	52,04

# Mangueras termoplásticas TrΔle

Thermoplastic hoses TrΔle

Tuyaux thermoplastiques TrΔle

Tubi termoplastici TrΔle

## Ecology 200

Ecology 200

Ecology 200

Ecology 200



DN	Ø INNER Ø INT.	Part n° Referencia	€
5/8"	16,3	MEC20010	19,74
3/4"	19,6	MEC20012	23,62
1"	25,9	MEC20016	30,44
1 1/4"	32,5	MEC20020	55,48

## Ecology 210

Ecology 210

Ecology 210

Ecology 210



DN	Ø INNER Ø INT.	Part n° Referencia	€
3/4"	19,6	MEC21012	30,24
1"	25,6	MEC21016	40,02
1 1/4"	32,4	MEC21020	55,48

## Ecology 250

Ecology 250

Ecology 250

Ecology 250



DN	Ø INNER Ø INT.	Part n° Referencia	€
3/4"	19,6	MEC25012	38,42
1"	25,9	MEC25016	54,71

## Casquillos para manguera Ecology

Ferrules for Ecology hose

Jupes pour tuyau Ecology

Boccole pressare per tubi Ecologici

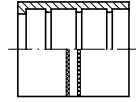

DN	Part n° Referencia	€
3/4"	Z212001200	*
1"	Z212001600	*
1 1/4"	Z212002000	*

Acero inoxidable AISI 316-L. Ver precios en Tarifa Inox p.22 / Stainless steel AISI 316-L. Prices in Stainless Steel Catalogue p.22 / Acier inoxydable AISI 316-L. Prix dans le Catalogue Acier Inox p.22 / Acciaio inossidabile AISI 316-L. Prezzi in Acciaio Inossidabile p.22

## Ecology tramos 120 metros

Ecology 120 meters/roll

Ecology 120 mètres / rouleau

Ecology 120 metri / rotoli



DN	Ø INNER Ø INT.	WP (bar) PRESIÓN TRABAJO (bar)	Part n° Referencia	€/m
3/4"	19,6	200	MEC20012120	23,62
1"	25,9	200	MEC20016120	30,44
3/4"	19,6	210	MEC21012120	30,24
1"	25,6	210	MEC21016120	40,02
3/4"	19,6	250	MEC25012120	38,42
1"	25,9	250	MEC25016120	54,71

Consultar | On request | Sur demande | Su richiesta



Conforme a la especificación CGA G-7.1-2004 relativa al material para respiración grado E, NFPA 1901

Complies with CGA G-7.1-2004 commodity specification for breathing air grade E, NFPA 1901



Manguera termoplástica alta presión 700 bar (10000 psi) para productos químicos agresivos

Thermoplastic conductive hose for very high pressure aggressive chemicals application sup to 700 bar (10000 psi)

# Tabla de roscas

Thread data table  
Tableau de raccords  
Tabella dei filetti

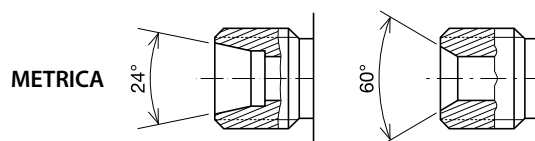

Métrica Metric Métrique Metrica	Ø ext.	Ø int.	Cono 24° 24° cone Cone 24° Cono 24°	Cono 60° 60° cone Cone 60° Cono 60°
12 x 1,5	12	10,05	•	•
14 x 1,5	14	12,05	•	•
16 x 1,5	16	14,05	•	•
18 x 1,5	18	16,05	•	•
20 x 1,5	20	18,05	•	•
22 x 1,5	22	20,05	•	•
24 x 1,5	24	22,05	•	•
26 x 1,5	26	24,05	•	•
30 x 1,5	30	28,05	•	•
30 x 2	30	27,40	•	•
36 x 2	36	33,40	•	•
38 x 1,5	38	36,05	•	•
42 x 2	42	39,40	•	•
45 x 1,5	45	43,05	•	•
45 x 2	45	42,40	•	•
52 x 1,5	52	50,05	•	•
52 x 2	52	49,40	•	•
65 x 2	65	64,40	•	•
78 x 2	78	75,40	•	•

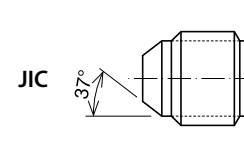

SAE	Ø ext.	Ø int.
7/16-20	11,07	10,00
1/2-20	12,70	11,60
9/16-18	14,25	13,00
5/8-18	15,85	14,70
3/4-16	19,00	17,60
7/8-14	22,17	20,50
1 1/16-12	26,95	25,00
1 1/16-14	26,95	25,30
1 5/16-12	33,30	31,30
1 5/16-14	33,30	31,60
1 5/8-12	41,42	39,20
1 5/8-14	41,22	39,50
1 7/8-12	47,57	45,60
1 7/8-14	47,57	45,90
2 1/2-12	63,45	61,50
3-12	76,20	74,30

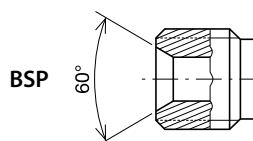

BSP	Ø ext.	Ø int.
1/4-19	13,16	11,50
3/8-19	16,66	14,90
1/2-14	20,96	18,60
5/8-14	22,91	20,60
3/4-14	26,44	24,10
1-11	33,25	30,30
1 1/4-11	41,91	38,90
1 1/2-11	47,80	44,90
2-11	59,62	56,70

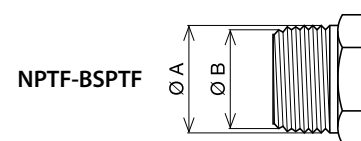

NPT cónicas Conical NPT NPT conique NPT conico	Ø A	Ø B	BSPT cónicos Conical BSPT BSPT conique BSPT conico	Ø A	Ø B
1/8-27	10,59	9,98	1/8-28	10,20	9,48
1/4-18	14,12	13,28	1/4-19	13,90	12,85
3/8-18	17,55	16,71	3/8-19	17,31	16,26
1/2-14	21,84	21,08	1/2-14	21,89	20,55
3/4-14	27,17	26,13	3/4-14	27,30	25,84
1-11,5	33,96	32,74	1-11	34,41	32,65
1 1/4-11,5	42,72	41,47	1 1/4-11	42,91	41,11
1 1/2-11,5	48,81	47,54	1 1/2-11	48,83	47,08
2-11,5	60,88	59,56	2-11	60,94	58,62

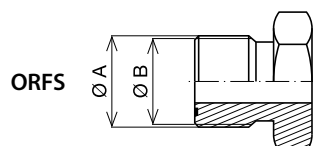

ORFS	Ø B	Ø A
9/16" 18h	13,0	14,25
11/16" 16h	15,4	17,40
13/16" 16h	18,6	20,05
1" 14h	23,1	25,30
1" 3/16 12h	27,5	30,10
1" 7/16 12h	33,8	36,40
1" 11/16 12h	40,2	42,80
2" 12h	48,1	50,70

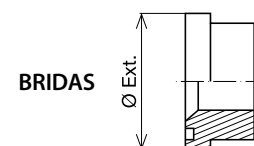

Brida SAE	Ø ext. 3000 PSI	Ø ext. 6000 PSI
1/2"	30,2	31,8
3/4"	38,1	41,3
1"	44,5	47,6
1" 1/4	50,8	54,0
1" 1/2	60,3	63,5
2"	71,4	79,4

\* Las bridas 9000 PSI son iguales en Ø a las 6000 PSI, pero con espesor de pletina 14,3 / 9000 PSI flanges have the same Ø as 6000 PSI, but with thickness deck 14,3 / Les brides 9000 PSI son égales en Ø aux brides 6000 PSI, mais l'épaisseur est de 14,3 mm. / Le flangia 9000 PSI hanno il medesimo Ø della serie 6000 PSI, cambia unicamente lo spessore a 14,3 mm.

# Racores para tubería flexible

*Flexible hose fittings*

Embouts à sertir

*Raccordi per tubi flessibili*

<b>Conexiones Standard</b>	34
<i>Standard series fittings</i>	
Embouts série Standard	
<i>Raccordi serie Standard</i>	
<b>Conexiones Serie BW no pelar R12 / 4SP / 4SH</b>	51
<i>BW fittings - no skiving R12 / 4SP / 4SH</i>	
Embouts BW sans dénuder R12 / 4SP / 4SH	
<i>Raccordi BW - 2 pezzi R12 / 4SP / 4SH</i>	
<b>Conexiones Interlock</b>	54
<i>Interlock series fittings</i>	
Embouts à sertir Interlock	
<i>Raccordi serie Interlock</i>	
<b>Conexiones Una sola pieza Serie 43</b>	62
<i>One piece fittings series 43</i>	
Embouts une seule pièce Série 43	
<i>Raccordi serie Standard CrIII un pezzo</i>	
<b>Conexiones Una sola pieza Serie BW</b>	68
<i>One piece fittings BW series</i>	
Embouts une seule pièce Série BW	
<i>Raccordi BW - 1 pezzo</i>	
<b>Conexiones Reusables</b>	71
<i>Reusable series fittings</i>	
Embouts Récuperables	
<i>Raccordi serie Recuperabile</i>	
<b>Conexiones alta presión (700 Bar)</b>	73
<i>High pressure 700 Bar fittings</i>	
Embouts haute pression 700 Bar	
<i>Raccordi Altissima pressione (700 Bar)</i>	

2

## Serie Standard

Serie Standard  
Standard serie  
Standard serie









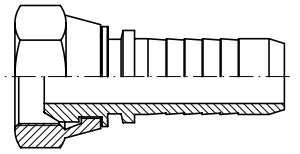







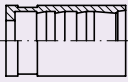
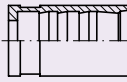
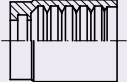

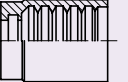
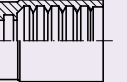



### Una única conexión para una amplia gama de mangueras

*One only fitting for a big hose range*

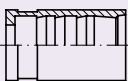
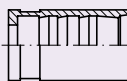
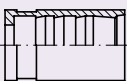
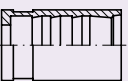
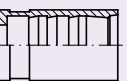
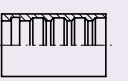
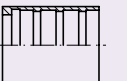
*Un seul raccord pour une grande gamme de tuyaux*

*Un solo raccordo per una vasta gamma di tubi*

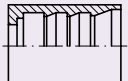
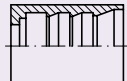
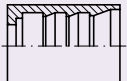
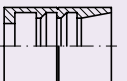
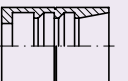
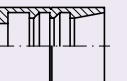

						
SAE 100 R6	EN 854 2TE	EN 854 3TE	EN 857 1SC SUPERSERVICE 15C 155°	EN 853 15N SAE 100 R1AT	EN 853 25N SAE 100 R2AT	EN 857 25C SUPERSERVICE 25C 155°
						
DI23	DI23	DI2212	SC2112	SC2112 DI2212	DI2212	DI2212
						
SAE 100 R7 EN 855	R7 Non-conductive	SAE 100 R8 EN 855	R8 Non-conductive	Metallic braid elastomer	Smooth PTFE 1 braid	Convoluted PTFE
						
DI23	DI23	DI23	DI23	DI23	21040	21041
						
EN 853 25T SAE100 R2A	EN 856 4SP SAE 100 R9R	SAE 100 EN 856 R12	Ecology 200	Ecology 210	Ecology 250	
						
DI1224	DI1224	DI1224	Z2120	Z2120	Z2120	



## Serie Interlock

Interlock serie  
Série Interlock  
Serie Interlock

■ **Una única conexión para toda la gama de mangueras de alta presión**

*One only fitting for all very high pressure hoses*

*Un seul raccord pour tous les tubes de très haute pression*

*Un solo raccordo per tutti i tubi ad altissima pressione*

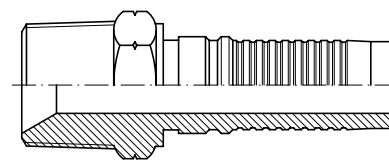

EN 856  
4SH

EN 856  
R13  
SAE 100

SAE 100  
R15

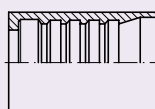

A61010

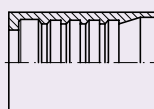

A61010  
61010

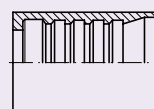

A61010  
61010

## Serie BW no pelar

*BW Series no skiving*

*Série BW sans dénuder*

*Serie BW non pelati*

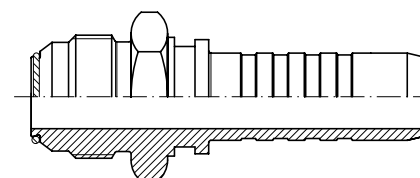

EN 856  
4SP  
SAE 100

EN 856  
4SH

EN 856  
R12  
SAE 100

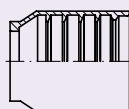

AC68010

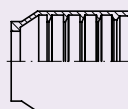

AC68010

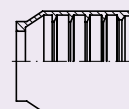

AC68010

# Conexiones Standard

Standard series fittings  
 Embouts série Standard  
 Raccordi serie Standard

## Casquillos para prensar / Crimping ferrules / Jupes à sertir / Boccole a pressare

34

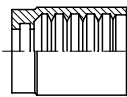

DI2212

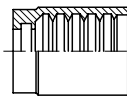

DI2212...R4

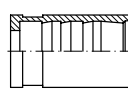

DI2300

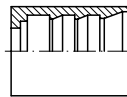

DI1224

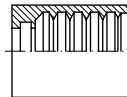

SC2112

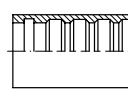

21040

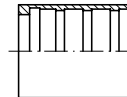

21041

## Conexiones BSP / BSP Fittings / Embouts BSP / Raccordi BSP

35

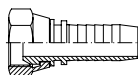

24100



24110

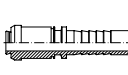

24110...L

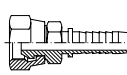

24400

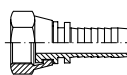

24200

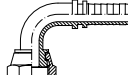

24207

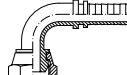

24107

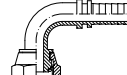

24117

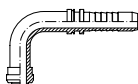

24117...L

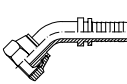

24108

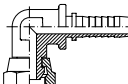

24127

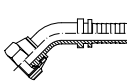

24118

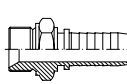

24112

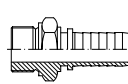

24212

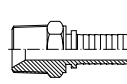

24114

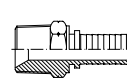

24161



24261

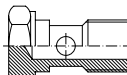

A1090

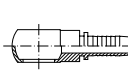

24111

## Conexiones JIC 37° / JIC 37° Fittings / Embouts JIC 37° / Raccordi JIC 37°

39



24142



24242



24138

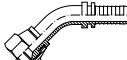

24139



24140



24300

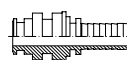

24190

## Conexiones Métricas DIN 2353 / Metric fittings DIN 2353 / Embouts Métriques DIN 2353 / Raccordi Metrici DIN 2353

41



24804

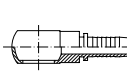

24116

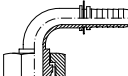

24305

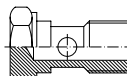

51092

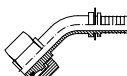

24306



2580496

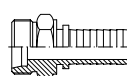

24203



24158

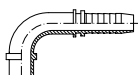

24258



24404

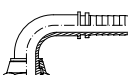

24405

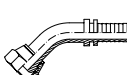

24406

## Conexiones Métricas Serie Francesa / Metric fittings French Serie / Embouts Métriques Série Française / Raccordi Metrici Serie Francese

44



24503



2450518



24504

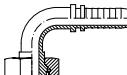

24505

# Conexiones Standard

Standard series fittings  
 Embouts série Standard  
 Raccordi serie Standard

Hoses

Flexible hose fittings

Flow measuring

Processing machine for flexible hoses

■ **Conexiones ORFS / ORFS Fittings / Embouts ORFS / Raccordi ORFS** | 45



■ **Bridas SAE 3000/6000 PSI / 3000/6000 PSI SAE Flanges / Brides SAE 3000/6000 PSI / Flangia SAE 3000/6000 PSI** | 46

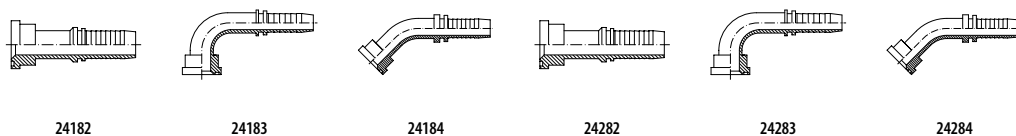

■ **Bridas 9000 PSI / 9000 PSI Flanges / Embouts brides / Flangia 9000 PSI** | 47

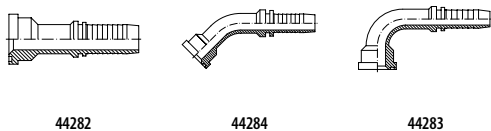

■ **Bridas SAE / SAE Flanges / Brides SAE / Flangia SAE** | 48

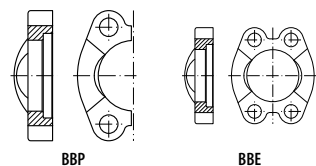

■ **Juntas y tornillos para bridas / Seals and screws for flanges / Joints et vis pour brides / O'Ring per flangia** | 48



■ **Pletinas de bridas Poclairn / Poclairn Flanges / Embouts brides type Poclairn / Flangia Poclairn** | 49

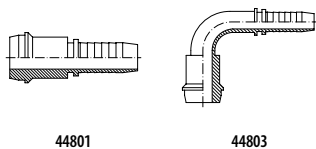

■ **Bridas Poclairn / Poclairn Flanges / Brides Poclairn / Flangia Poclairn** | 49

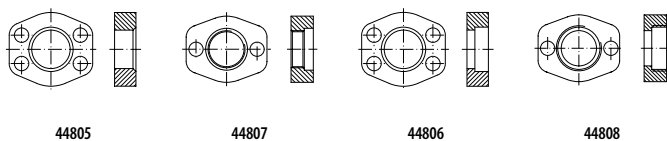

■ **Racores para hidrolavadoras / Karcher fittings / Embouts Karcher / Raccordi per idropultrici** | 50



## Conexiones Serie BW no pelar R12 / 4SP / 4SH

*BW fittings - no skiving R12 / 4SP / 4SH*

*Embouts BW sans dénuder R12 / 4SP / 4SH*

*Raccordi BW - 2 pezzi R12 / 4SP / 4SH*

### ■ Casquillos compactos serie BW / Ferrules for fittings BW series / Jupes pour embouts série BW / Boccole pressare per raccordi serie BW

51

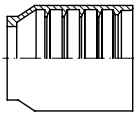

AC68010

### ■ Conexiones BSP / BSP Fittings / Embouts BSP / Raccordi BSP

51



66110

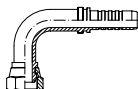

66117

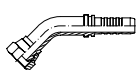

66118



66112

### ■ Conexiones JIC 37° / JIC 37° Fittings / Embouts JIC 37° / Raccordi JIC 37°

51



66140



66242

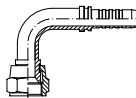

66138

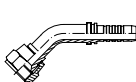

66139

### ■ Conexiones Métricas DIN 2353 / Metric fittings / Embouts Métriques / Raccordi Metrici

52

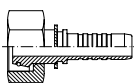

66204

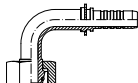

66205

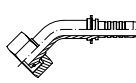

66206

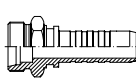

66203

### ■ Bridas SAE 3000/6000 PSI / SAE Flanges 3000/6000 PSI / Brides SAE 3000/6000 PSI / Flangia SAE 3000/6000 PSI

52



66182



66183

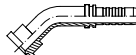

66184



66282



66283

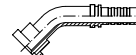

66284

### ■ Conexiones ORFS / ORFS Fittings / Embouts ORFS / Raccordi ORFS

53



66901



66907

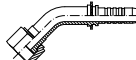

66908

# Conexiones Interlock

Interlock series fittings  
Emboutis à sertir Interlock  
Raccordi serie Interlock

## Casquillos / Crimping ferrules / Jupes / Boccole a pressare

54

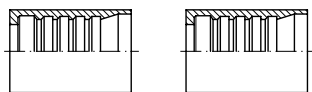

A61010

61010

## Conexiones BSP / BSP Fittings / Embouts BSP / Raccordi BSP

54

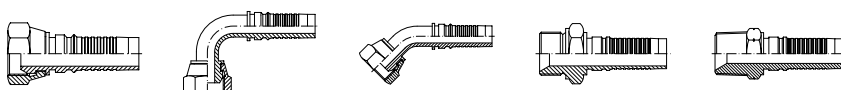

64100

64107

64108

64112

64161

## Conexiones JIC 37° / JIC 37° Fittings / Embouts JIC 37° / Raccordi JIC 37°

55

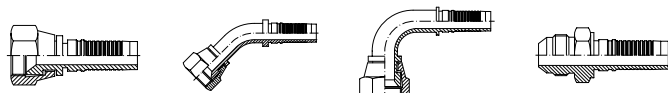

64142

64139

64138

64140

## Conexiones Métricas DIN 2353 / Metric fittings DIN 2353 / Embouts Métriques DIN 2353 / Raccordi Metrici DIN 2353

55

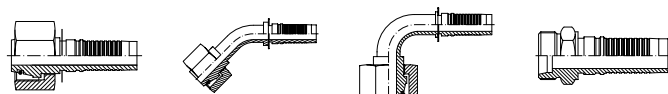

64204

64206

64205

64203

## Conexiones ORFS / ORFS fittings / Embouts ORFS / Raccordi ORFS

56

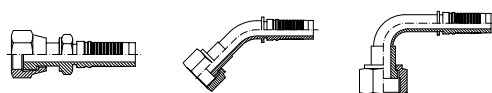

64900

64908

64907

## Racores para martillo / Fittings for hammer / Embouts pour marteau / Raccordi per martello

56

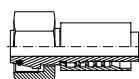

NAM

## Bridas SAE 3000/6000 PSI / 3000/6000 PSI SAE Flanges / Embouts brides SAE 3000/6000 PSI / Flangia SAE 3000/6000 PSI

57

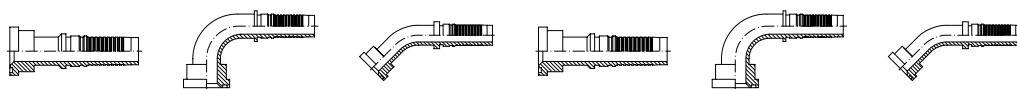

64182

64183

64184

64282

64283

64284

## Bridas 9000 PSI / 9000 PSI Flanges / Embouts brides 9000 PSI / Flangia 9000 PSI

58

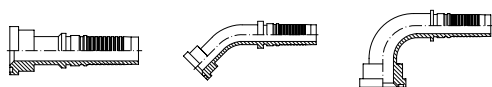

64382

64384

64383

# Conexiones Interlock

*Interlock series fittings*  
 Embouts à sertir Interlock  
 Raccordi serie Interlock

■ **Bridas Poclair / Poclair flanges / Embouts brides Poclair / Flangia Poclair**

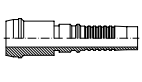

64801

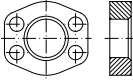

44805

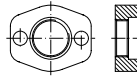

44807



64802

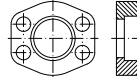

44806

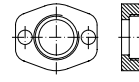

44808

# Conexiones Una sola pieza Serie 43

*One piece fittings series 43*

*Embouts une seule pièce Série 43*

*Raccordi un pezzo Serie 43*

## ■ Casquillos Una sola pieza / Ferrules for One Piece Fittings / Jupes pour Embouts une seule pièce / Boccole per Raccordi un pezzo

61

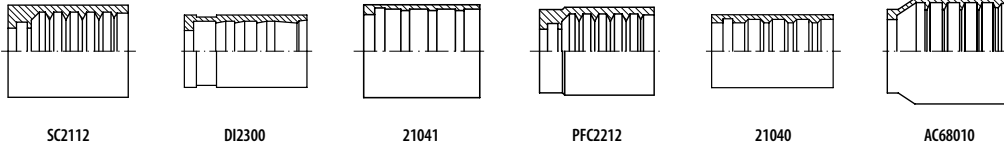

## ■ Conexiones una sola pieza JIC 37° / One piece JIC 37° fittings / Embouts pré-sertis JIC 37° / Raccordi compatti JIC 37°

62

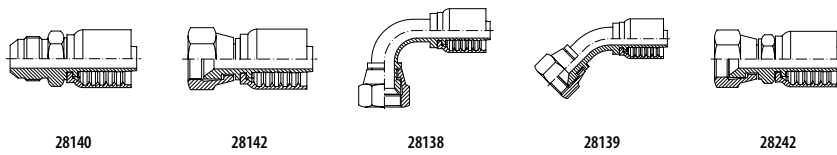

## ■ Conexiones una sola pieza ORFS / One piece ORFS fittings / Embouts pré-sertis ORFS / Raccordi compatti ORFS

63

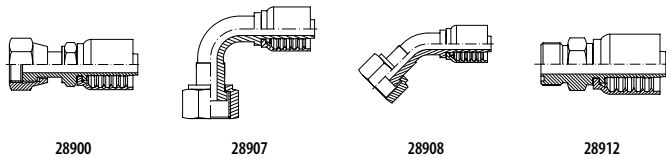

## ■ Conexiones una sola pieza NPT-NPSM / One piece NPT-NPSM fittings / Embouts pré-sertis NPT-NPSM / Raccordi compatti NPT-NPSM

64

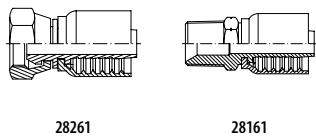

## ■ Conexiones una sola pieza Bridas SAE / One piece SAE Flanges fittings / Embouts pré-sertis Brides SAE / Raccordi compatti Flange SAE

64

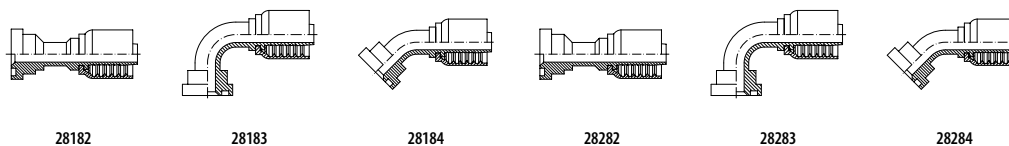

## ■ Conexiones una sola pieza Métricas / One piece Metric fittings / Embouts pré-sertis Métriques / Raccordi compatti Metrici

65

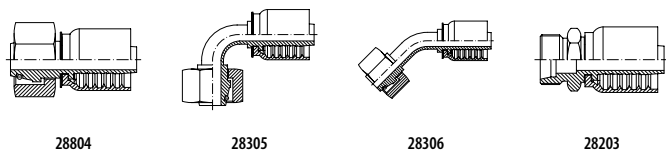

## ■ Conexiones una sola pieza BSP / One piece BSP fittings / Embouts pré-sertis BSP / Raccordi compatti BSP

66

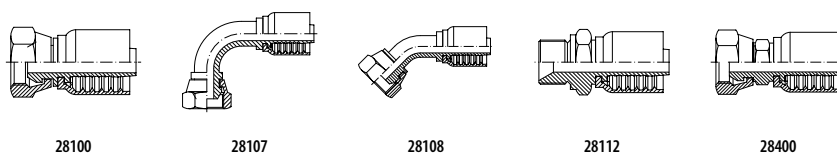

# Conexiones Una sola pieza Serie BW

*One piece fittings BW series*

*Emboutis une seule pièce Série BW*

*Raccordi BW - 1 pezzo*

## ■ Conexiones JIC 37° / JIC 37° Fittings / Embouts JIC 37° / Raccordi JIC 37°

67

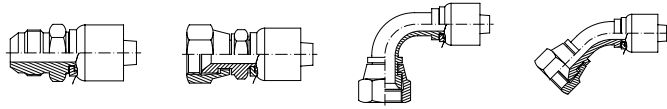

68140

68242

68138

68139

## ■ Conexiones ORFS / ORFS Fittings / Embouts ORFS / Raccordi ORFS

67

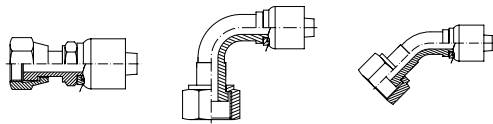

68901

68907

68908

## ■ Bridas SAE 3000/6000 PSI / SAE Flanges 3000/6000 PSI / Brides SAE 3000/6000 PSI / Flangia SAE 3000/6000 PSI

68

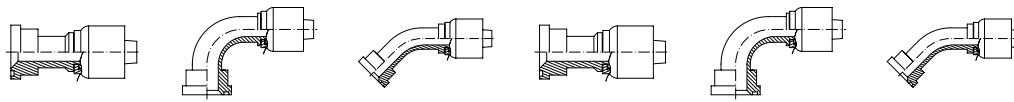

68182

68183

68184

68282

68283

68284

## ■ Conexiones Métricas DIN 2353 / Metric fittings / Embouts Métriques / Raccordi Metrici DIN 2353

69

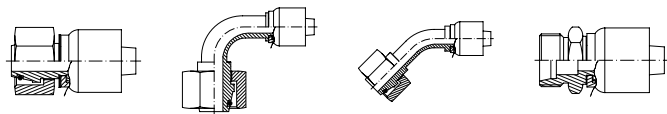

68204

68205

68206

68203

## ■ Conexiones BSP / BSP Fittings / Embouts BSP / Raccordi BSP

69

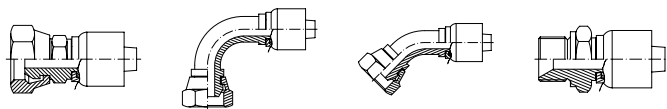

68110

68107

68108

68112



# Conexiones Reusables

Reusable series fittings  
 Embouts Récuperables  
 Raccordi serie Recuperabile

## Casquillos / Ferrules / Jupes / Boccole recuperabili

70

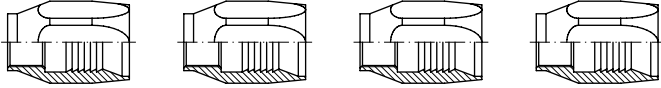

A1G...R1

A1G...R1T

A1G...R2

A1G...R2T

## Conexiones / Fittings / Embouts / Raccordi recuperabili

70

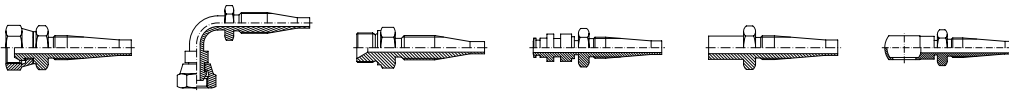

A3G

A90G

A2G

S2G

AE

A0G

# Conexiones alta presión (700 Bar)

High pressure 700 Bar fittings  
 Embouts haute pression 700 Bar  
 Raccordi Altissima pressione (700 Bar)

## Casquillos / Ferrules / Jupes à sertir / Boccole

72

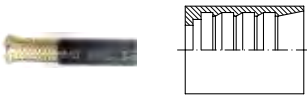

MT700

71012

## Conexiones BSP / BSP Fittings / Embouts BSP / Raccordi BSP

72

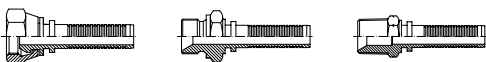

74100

74112

74161

# Conexiones Standard

Standard series fittings  
Embouts série Standard  
Raccordi serie Standard

## Casquillos R1AT/R2AT/1SN/2SN/2SC/R16

Ferrules R1AT/R2AT/1SN/2SN/2SC/R16

Jupes à sertir R1AT/R2AT/1SN/2SN/2SC/R16

Boccole a pressare per R1AT/R2AT/1SN/2SN/2SC/R16

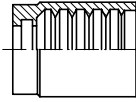

DN	Part n° Referencia	€
3/16"	DI221200300	1,06
1/4"	DI221200400	0,86
5/16"	DI221200501	0,86
3/8"	DI221200600	0,99
1/2"	DI221200800	1,17
5/8"	DI221201000	1,57
3/4"	DI221201200	1,94
1"	DI221201600	4,85
1"1/4	DI221202000	12,13
1"1/2	DI221202400	16,07
2"	DI221203200	21,59

## Casquillos R4

Ferrules R4

Jupes à sertir R4

Boccole a pressare per R4

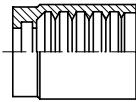

DN	Part n° Referencia	€
3/4	DI221201200R4	7,27

Para otros tamaños usar serie DI2212 y ver tabla de prensado en nuestra web. / For other sizes, please use the DI2212 series and see the crimping table on our website. / Pour d'autres dimensions, utilisez la série DI2212 et consultez la table de sertissage dans notre website.

## Casquillos R6, R7, R8 y malla metálica

Ferrules SAE 100 R6, R7, R8 and metallic braid

Jupes à sertir R6, R7, R8 et tresse métallique

Boccole a pressare per SAE R6, R7, R8 e Treccia Metallica

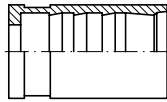

DN	Part n° Referencia	€
1/8"	DI2300200	0,97
3/16"	DI2300300	0,80
1/4"	DI2300400	0,76
5/16"	DI2300500	1,31
3/8"	DI2300600	1,11
1/2"	DI2300800	1,39
5/8"	DI2301000	2,61
3/4"	DI2301200	3,68
1"	DI2301600	6,86

## Casquillos R2A/R9R/2ST/4SP

Ferrules R2A/R9R/2ST/4SP

Jupes à sertir R2A/R9R/2ST/4SP

Boccole a pressare per R2A/R9R/2ST/4SP

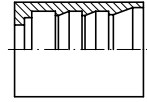

DN	Part n° Referencia	€
1/4"	DI122400400	1,09
5/16"	DI122400500	1,46
3/8"	DI122400600	1,31
1/2"	DI122400800	1,64
5/8"	DI122401000	2,31
3/4"	DI122401200	2,89
1"	DI122401600	4,94
1"1/4	DI122402000	12,86
1"1/2	DI122402400	16,28
2"	DI122403200	23,80

## Casquillos 1SC/1SN/2SC/R6/2TE

Ferrules 1SC/1SN/2SC/R6/2TE

Jupes à sertir 1SC/1SN/2SC/R6/2TE

Boccole a pressare per 1SC/1SN/2SC/R6/2TE

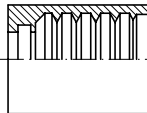

DN	Part n° Referencia	€
1/4"	SC21120400	1,09
5/16"	SC21120500	0,97
3/8"	SC21120600	1,17
1/2"	SC21120800	1,68
5/8"	SC21121000	2,30
3/4"	SC21121200	2,64
1"	SC21121600	5,15

# Conexiones Standard

Standard series fittings  
Embouts série Standard  
Raccordi serie Standard

Hoses

Flexible hose fittings

Flow measuring

Processing machine  
for flexible hoses

## Casquillos PTFE Liso alta presión

Ferrules for Smooth PTFE

Jupes à sertir pour PTFE Lisse haute pression

Boccole a pressare per tubo al PTFE Liscio alta pressione

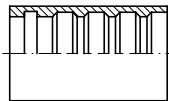

DN	Part n° Referencia	€
3/16"	210400300	1,20
1/4"	210400400	1,11
5/16"	210400500	1,36
3/8"	210400600	1,21
1/2"	210400800	1,50
5/8"	210401000	2,10
3/4"	210401200	2,36
1"	210401600	4,44

## Casquillos PTFE Corrugado alta presión

Ferrules for Corvuluted PTFE

Jupes à sertir PTFE Convoluté haute pression

Boccole a pressare per tubo al PTFE Corrugato alta pressione

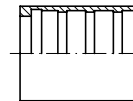

DN	Part n° Referencia	€
1/4"	210410400	1,30
3/8"	210410600	1,63
1/2"	210410800	1,55
5/8"	210411000	2,83
3/4"	210411201	2,96
1"	210411600	4,79
1" 1/4	210412001	10,82
1" 1/2	210412400	11,92
2"	210413200	19,99

## Hembras giratorias rectas BSP cono 60°

BSP Swivel female 60° cone

Femelle tournante gaz cyl BSP 60°

Femmina diritta BSP sede 60°

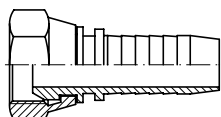

DN	THREAD ROSCA	Part n° Referencia	€
1/8"	1/8" BSP	241000202	1,64
3/16"	1/8" BSP	241000203	1,15
1/4"	1/8" BSP	241000204	1,39
3/16"	1/4" BSP	241000403	1,67
1/4"	1/4" BSP	241000404	1,17
5/16"	1/4" BSP	241000405	1,51
3/8"	1/4" BSP	241000406	1,98
1/4"	3/8" BSP	241000604	1,77
5/16"	3/8" BSP	241000605	1,69
3/8"	3/8" BSP	241000606	1,38
1/2"	3/8" BSP	241000608	2,29
1/4"	1/2" BSP	241000804	2,46
3/8"	1/2" BSP	241000806	2,34
1/2"	1/2" BSP	241000808	1,99
5/8"	1/2" BSP	241000810	3,28
1/2"	5/8" BSP	241001008	3,10
5/8"	5/8" BSP	241001010	3,03
1/2"	3/4" BSP	241001208	3,83
5/8"	3/4" BSP	241001210	3,79
3/4"	3/4" BSP	241001212	3,69
3/4"	1" BSP	241001612	6,37
1"	1" BSP	241001616	6,04

Para aquellas mayores de 1" ver con junta / For those bigger than 1" see with o'ring / Pour ceux plus grand que 1" voir avec o'ring / Per quelli più grandi di 1" vedere con o'ring

## Hembras giratorias rectas BSP cono 60° con junta tórica

BSP Swivel female 60° with o'ring

Femelle tournante droit gaz cyl BSP 60° + o'ring

Femmina diritta BSP sede 60° con o'ring

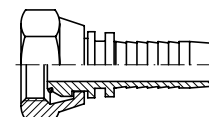

DN	THREAD ROSCA	Part n° Referencia	€
1/4"	1/4" BSP	241100404	1,89
3/8"	3/8" BSP	241100606	1,89
1/2"	1/2" BSP	241100808	2,88
5/8"	5/8" BSP	241101010	4,71
5/8"	3/4" BSP	241101210	4,01
3/4"	3/4" BSP	241101212	4,01
1"	1" BSP	241101616	8,33
1"	1" 1/4 BSP	241102016	14,46
1" 1/4	1" 1/4 BSP	241102020	15,14
1" 1/4	1" 1/2 BSP	241102420	19,87
1" 1/2	1" 1/2 BSP	241102424	19,68
1" 1/2	2" BSP	241103224	37,03
2"	2" BSP	241103232	35,77

## Hembras giratorias rectas BSP cono 60° con junta tórica tuerca libre

BSP Swivel female 60° with o'ring, loose nut

Femelle tournante droite gaz cyl BSP 60° + o'ring, écrou libre

Femmina diritta BSP sede 60° con o'ring, dado libero

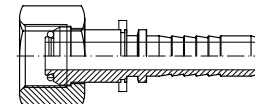

DN	THREAD ROSCA	Part n° Referencia	€
1/4	1/4	241100404L	3,13
3/8	3/8	241100606L	5,05
1/2	1/2	241100808L	4,88

# Conexiones Standard

Standard series fittings  
Embouts série Standard  
Raccordi serie Standard

## Hembras giratorias BSP 60° doble hexagono

BSP Swivel female 60° cone double hex.

Femelle tournante BSP cône 60° double hexagonal

Femmina diritta BSP sede 60° doppio esagono

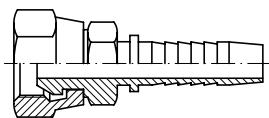

DN	THREAD ROSCA	Part n° Referencia	€
1/4"	1/4" BSP	244000404	2,34
5/16"	3/8" BSP	244000605	2,78
3/8"	3/8" BSP	244000606	2,78
1/2"	1/2" BSP	244000808	3,56
3/4"	3/4" BSP	244001212	7,01
1"	1" BSP	244001616	10,02
1" 1/4	1" 1/4 BSP	244002020	21,14
1" 1/2	1" 1/2 BSP	244002424	32,27
2"	2" BSP	244003232	53,42

## Hembras giratorias rectas BSP asiento plano

BSP Swivel female flat seat

Femelle tournante fond plat BSP

Femmina diritta BSP sede piana

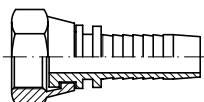

DN	THREAD ROSCA	Part n° Referencia	€
1/4"	1/4" BSP	242000404	1,56
5/16"	3/8" BSP	242000605	2,13
3/8"	3/8" BSP	242000606	2,13
3/8"	1/2" BSP	242000806	2,91
1/4"	1/2" BSP	242000804 *	4,04
1/2"	1/2" BSP	242000808	3,16
1/2"	3/4" BSP	242001208	4,21
3/4"	3/4" BSP	242001212	4,56
1"	1" BSP	242001616	7,58
1" 1/4	1" 1/4 BSP	242002020	16,22
1" 1/2	1" 1/2 BSP	242002424	21,50

\*Hasta fin de existencias. / \*Until end of stock. / \*Jusqu'à la fin du stock. / \*Fino ad esaurimento scorta.

## Hembras giratorias 90° BSP asiento plano

BSP Swivel female flat seat (90° Elbow)

Embout à sertir coude 90° femelle tournante fond plat BSP

Femmina a 90° BSP sede 60° sede piana

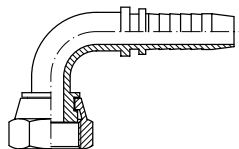

DN	THREAD ROSCA	Part n° Referencia	€
1/4"	1/4" BSP	242070404	2,56
3/8"	3/8" BSP	242070606	3,48
1/2"	1/2" BSP	242070808	4,61
3/4"	3/4" BSP	242071212	9,21
1"	1" BSP	242071616	16,38

## Hembras giratorias 90° BSP cono 60°

BSP Swivel female 60° cone (90° Elbow)

Coude 90° femelle tournante gaz cyl BSP 60°

Femmina a 90° BSP sede 60°

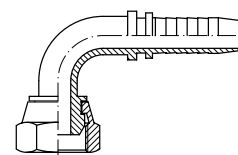

DN	THREAD ROSCA	Part n° Referencia	€
3/16"	1/8" BSP	241070203	2,38
1/4"	1/8" BSP	241070204	1,80
3/16"	1/4" BSP	241070403	2,21
1/4"	1/4" BSP	241070404	1,94
1/4"	3/8" BSP	241070604	2,71
5/16"	3/8" BSP	241070605	2,79
3/8"	3/8" BSP	241070606	2,39
1/4"	1/2" BSP	241070804	4,34
3/8"	1/2" BSP	241070806	3,49
1/2"	1/2" BSP	241070808	3,10
1/2"	5/8" BSP	241071008	6,55
5/8"	5/8" BSP	241071010	5,92
1/2"	3/4" BSP	241071208	6,62
5/8"	3/4" BSP	241071210	6,50
3/4"	3/4" BSP	241071212	6,13
3/4"	1" BSP	241071612	11,64
1"	1" BSP	241071616	11,51

Para aquellas mayores de 1" ver con junta / For those bigger than 1" see with o'ring / Pour ceux plus grand que 1" voir avec o'ring / Per quelli più grandi di 1" vedere con o'ring

## Hembras giratorias 90° BSP cono 60° con junta tórica

BSP Swivel female 60° cone with o'ring (90° Elbow)

Coude 90° femelle tournante gaz cyl BSP 60° + o'ring

Femmina a 90° BSP sede 60° con o'ring

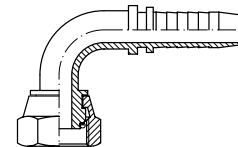

DN	THREAD ROSCA	Part n° Referencia	€
1/4"	1/4" BSP	241170404	3,01
3/8"	3/8" BSP	241170606	3,89
1/2"	1/2" BSP	241170808	5,45
5/8"	5/8" BSP	241171010	7,27
3/4"	3/4" BSP	241171212	8,81
1"	1" BSP	241171616	15,56
1"	1" 1/4 BSP	241172016	24,08
1" 1/4	1" 1/4 BSP	241172020	28,25
1" 1/4	1" 1/2 BSP	241172420	41,86
1" 1/2	1" 1/2 BSP	241172424	32,76
2"	2" BSP	241173232	77,40

## Hembras giratorias 90° BSP cono 60° con junta tórica tuerca libre

BSP Swivel female 60° with o'ring, loose nut (90° Elbow)

Coude 90° femelle tournante gaz cyl BSP 60° + o'ring, écrou libre

Femmina a 90° BSP sede 60° con o'ring, dado libero

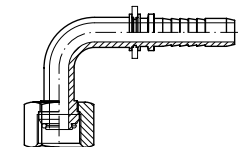

DN	THREAD ROSCA	Part n° Referencia	€
1/4	1/4	241170404L	6,56
3/8	3/8	241170606L	7,33
1/2	1/2	241170808L	10,08

# Conexiones Standard

Standard series fittings  
Embouts série Standard  
Raccordi serie Standard

Hoses

Flexible hose fittings

Flow measuring

Processing machine  
for flexible hoses

## Hembras giratorias 45° BSP cono 60°

BSP Swivel female 60° cone (45° Elbow)

Coude 45° femelle tournante gaz cyl BSP 60°

Femmina a 45° BSP sede 60°

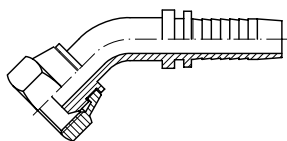

DN	THREAD ROSCA	Part n° Referencia	€
3/16"	1/8" BSP	241080203	2,58
1/4"	1/8" BSP	241080204	1,96
3/16"	1/4" BSP	241080403	2,40
1/4"	1/4" BSP	241080404	2,04
1/4"	3/8" BSP	241080604	2,62
5/16"	3/8" BSP	241080605	2,98
3/8"	3/8" BSP	241080606	2,84
3/8"	1/2" BSP	241080806	3,86
1/2"	1/2" BSP	241080808	4,07
1/2"	5/8" BSP	241081008	6,06
5/8"	5/8" BSP	241081010	6,06
5/8"	3/4" BSP	241081210	7,30
3/4"	3/4" BSP	241081212	7,79
3/4"	1" BSP	241081612	13,06
1"	1" BSP	241081616	12,17

Para aquellas mayores de 1" ver con junta / For those bigger than 1" see with o'ring / Pour ceux plus grand que 1" voir avec o'ring / Per quelli più grandi di 1" vedere con o'ring

## Hembras giratorias 90° BSP cono 60° (compactas)

BSP Swivel female 60° cone compact (90° Elbow)

Coude 90° femelle tournante compact gaz cyl BSP 60°

Femmina a 90° BSP sede 60° (compatta)

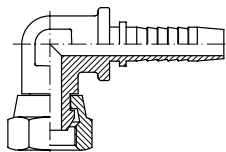

DN	THREAD ROSCA	Part n° Referencia	€
1/4"	1/4" BSP	241270404	3,69
3/8"	3/8" BSP	241270606	4,83
1/2"	1/2" BSP	241270808	6,06
3/4"	3/4" BSP	241271212	13,76

## Hembras giratorias 45° BSP cono 60° con junta tórica

BSP Swivel female 60° cone with o'ring (45° Elbow)

Coude 45° femelle tournante gaz cyl BSP 60° + o'ring

Femmina a 45° BSP sede 60° con o'ring

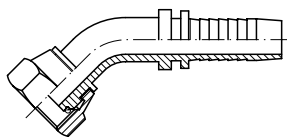

DN	THREAD ROSCA	Part n° Referencia	€
3/8"	3/8" BSP	241180606	5,41
1/2"	1/2" BSP	241180808	6,83
5/8"	5/8" BSP	241181010	7,90
5/8"	3/4" BSP	241181210 *	10,75
3/4"	3/4" BSP	241181212	11,88
1"	1" BSP	241181616	14,04
1"1/4"	1"1/4 BSP	241182020	18,72
1"1/2"	1"1/2 BSP	241182424	20,72
1"1/2"	2" BSP	241183224 *	123,05
2"	2" BSP	241183232	41,53

\*Hasta fin de existencias. / \*Until end of stock. / \*Jusqu'à la fin du stock. / \*Fino ad esaurimento scorta.

## Macho rosca cilíndrica BSP cono 60°

BSP Male parallel 60° cone

Mâle fixe gaz cyl BSP 60°

Maschio BSP cilindrico sede 60°

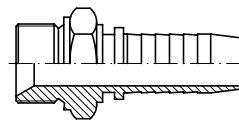

DN	THREAD ROSCA	Part n° Referencia	€
3/16"	1/8" BSP	241120203	1,23
1/4"	1/8" BSP	241120204	1,39
1/8"	1/4" BSP	241120402	4,93
3/16"	1/4" BSP	241120403	2,88
1/4"	1/4" BSP	241120404	1,37
3/8"	1/4" BSP	241120406	2,07
1/4"	3/8" BSP	241120604	2,06
5/16"	3/8" BSP	241120605	2,04
3/8"	3/8" BSP	241120606	1,69
1/2"	3/8" BSP	241120608	2,48
1/4"	1/2" BSP	241120804	2,81
3/8"	1/2" BSP	241120806	2,31
1/2"	1/2" BSP	241120808	2,18
1/2"	5/8" BSP	241121008	4,61
5/8"	5/8" BSP	241121010	3,68
1/2"	3/4" BSP	241121208	4,51
5/8"	3/4" BSP	241121210	4,51
3/4"	3/4" BSP	241121212	3,81
3/4"	1" BSP	241121612	8,78
1"	1" BSP	241121616	7,04
1"	1"1/4 BSP	241122016	17,20
1"1/4"	1"1/4 BSP	241122020	15,26
1"1/2"	1"1/2 BSP	241122424	17,55
2"	2" BSP	241123232	43,53

## Macho rosca cilíndrica BSP asiento plano

BSP Male flat seat

Mâle fixe gaz cyl fond plat

Maschio BSP cilindrico sede piana

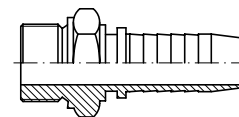

DN	THREAD ROSCA	Part n° Referencia	€
1/4"	1/4" BSP	242120404	2,23
3/8"	3/8" BSP	242120606	3,05
3/8"	1/2" BSP	242120806	4,27
1/2"	1/2" BSP	242120808	3,93
3/4"	3/4" BSP	242121212	5,98
1"	1" BSP	242121616	11,06

# Conexiones Standard

Standard series fittings  
Embouts série Standard  
Raccordi serie Standard

## Macho rosca cónica BSPT

*BSPT Male tapered*

*Mâle fixe gaz conique BSPT*

*Maschio BSPT conico*

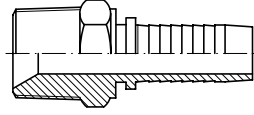

DN	THREAD ROSCA	Part n° Referencia	€
3/16"	1/8" BSPT	241140203	1,20
1/4"	1/8" BSPT	241140204	1,05
1/4"	1/4" BSPT	241140404	1,05
1/4"	3/8" BSPT	241140604	1,66
5/16"	3/8" BSPT	241140605	1,66
3/8"	3/8" BSPT	241140606	1,54
3/8"	1/2" BSP	241140806	2,06
1/2"	1/2" BSP	241140808	2,32
5/8"	3/4" BSPT	241141210	3,60
3/4"	3/4" BSPT	241141212	3,54
3/4"	1" BSPT	241141612	7,37
1"	1" BSPT	241141616	8,21
1"	1"1/4 BSPT	241142016	13,34
1" 1/4	1"1/4 BSPT	241142020	15,52
1" 1/2	1" 1/2 BSPT	241142424	15,45
2"	2" BSPT	241143232	38,70

## Macho rosca cónica NPT

*NPT Male thread*

*Mâle fixe gaz conique NPT*

*Maschio NPT conico*

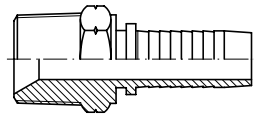

DN	THREAD ROSCA	Part n° Referencia	€
3/16"	1/8" NPT	241610203	1,52
1/4"	1/8" NPT	241610204	1,57
3/16"	1/4" NPT	241610403	1,57
1/4"	1/4" NPT	241610404	1,57
5/16"	1/4" NPT	241610405	2,37
3/8"	1/4" NPT	241610406	2,37
1/4"	3/8" NPT	241610604	2,37
5/16"	3/8" NPT	241610605	2,37
3/8"	3/8" NPT	241610606	1,91
1/2"	3/8" NPT	241610608	2,88
3/8"	1/2" NPT	241610806	2,88
1/2"	1/2" NPT	241610808	2,27
5/8"	1/2" NPT	241610810	4,11
1/2"	3/4" NPT	241611208	5,34
5/8"	3/4" NPT	241611210	4,23
3/4"	3/4" NPT	241611212	3,34
1"	3/4" NPT	241611216	7,86
3/4"	1" NPT	241611612	7,86
1"	1" NPT	241611616	7,23
1"	1"1/4 NPT	241612016	15,91
1"1/4	1"1/4 NPT	241612020	13,53
1"1/4	1"1/2 NPT	241612420	21,14
1"1/2	1"1/2 NPT	241612424	19,45
1"1/2	2" NPT	241613224	40,28
2"	2" NPT	241613232	37,05

## Hembras giratorias NPSM

*NPSM swivel female*

*Femelle tournante NPSM*

*Femmina diritta NPSM*

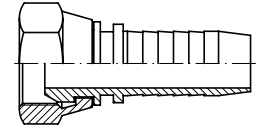

DN	THREAD ROSCA	Part n° Referencia	€
1/4"	1/4" NPSM	242610404	1,88
3/8"	3/8" NPSM	242610606	2,21
1/2"	1/2" NPSM	242610808	2,87
3/4"	3/4" NPSM	242611212	4,51
1"	1" NPSM	242611616	7,54

## Tornillo orientable simple BSP

*BSP bolt for Banjo*

*Vis creuse simple pour banjo filetage gaz BSP*

*Bullone forato BSP*

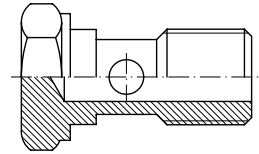

THREAD ROSCA	Part n° Referencia	€
1/8" BSP	A109002	*
1/4" BSP	A109004	*
3/8" BSP	A109006	*
1/2" BSP	A109008	*
3/4" BSP	A109012	*
1" BSP	A109016	*
1"1/4 BSP	A109020	*
1"1/2 BSP	A109024	*

\*Ver precios en p.263 (ADAPTADORES BSP) / \*See prices in p.263 (BSP ADAPTORS) / \*Prix à la p.263 (ADAPTEURS BSP) / \*Vedere prezzi p.263 (ADATTATORI BSP)

## Orientable BSP

*Banjo BSP*

*Embout Banjo droit gaz*

*Raccordo ad occhio BSP*

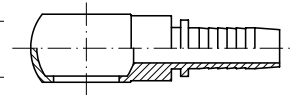

DN	Ø	Part n° Referencia	€
3/16"	1/4" BSP	241110403	2,80
1/4"	1/4" BSP	241110404	2,13
5/16"	1/4" BSP	241110405	2,95
3/8"	1/4" BSP	241110406	2,95
1/4"	3/8" BSP	241110604	3,36
5/16"	3/8" BSP	241110605	3,33
3/8"	3/8" BSP	241110606	3,09
1/2"	3/8" BSP	241110608	3,33
3/8"	1/2" BSP	241110806	4,63
1/2"	1/2" BSP	241110808	4,63
5/8"	5/8" BSP	241111010	9,36
1/2"	3/4" BSP	241111208	10,73
5/8"	3/4" BSP	241111210	11,80
3/4"	3/4" BSP	241111212	11,96
1"	1" BSP	241111616	24,16

# Conexiones Standard

Standard series fittings  
Embouts série Standard  
Raccordi serie Standard

Hoses

Flexible hose fittings

Flow measuring

Processing machine  
for flexible hoses

## Hembras giratorias rectas JIC 37°

JIC Swivel female 37° cone

Femelle tournante droite JIC cône 37°

Femmina diritta JIC 37°

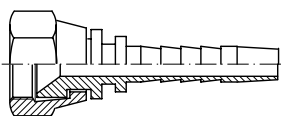

DN	THREAD ROSCA	Part n° Referencia	€
3/16"	7/16" 20h UNF	241420703	1,54
1/4"	7/16" 20h UNF	241420704	1,21
1/4"	1/2" 20h UNF	241420804	1,40
5/16"	1/2" 20h UNF	241420805	1,97
1/4"	9/16" 18h UNF	241420904	1,37
5/16"	9/16" 18h UNF	241420905	1,40
3/8"	9/16" 18h UNF	241420906	1,41
3/8"	5/8" 18h UNF	241421006	2,48
5/16"	3/4" 16h UNF	241421205	2,11
3/8"	3/4" 16h UNF	241421206	1,91
1/2"	3/4" 16h UNF	241421208	2,11
3/8"	7/8" 14h UNF	241421406	2,55
1/2"	7/8" 14h UNF	241421408	2,33
5/8"	7/8" 14h UNF	241421410	2,89
1/2"	1"1/16 12h UNF	241421708	4,20
5/8"	1"1/16 12h UNF	241421710	3,98
3/4"	1"1/16 12h UNF	241421712	3,59
1"	1"1/16 12h UNF	241421716	7,41
3/4"	1"5/16 12h UNF	241422112	7,72
1"	1"5/16 12h UNF	241422116	7,79
1"	1"5/8 12h UNF	241422616	13,25
1"1/4"	1"5/8 12h UNF	241422620	13,34
1"1/4"	1"7/8 12h UNF	241423020	25,89
1"1/2"	1"7/8 12h UNF	241423024	18,55
2"	2"1/2 12h UNF	241424032	34,40

## Hembras giratorias rectas JIC 37° doble hexagono

JIC swivel female 37° cone double hex.

Femelle JIC 37° double hexagonal

Femmina diritta JIC 37° doppio esagono

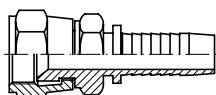

DN	THREAD ROSCA	Part n° Referencia	€
1/4"	7/16" 20h UNF	242420704	2,05
1/4"	1/2" 20h UNF	242420804	2,25
5/16"	9/16" 18h UNF	242420905	2,76
3/8"	9/16" 18h UNF	242420906	2,76
3/8"	3/4" 16h UNF	242421206	3,07
1/2"	3/4" 16h UNF	242421208	3,58
1/2"	7/8" 14h UNF	242421408	4,13
3/4"	1"1/16 12h UN	242421712	6,14
1"	1"5/16 12h UN	242422116	9,42
1"1/4"	1"5/8 12h UN	242422620	19,97
1"1/2"	1"7/8 12h UN	242423024	30,71
2"	2"1/2 12h UN	242424032	51,19

## Hembras giratorias 90° JIC 37°

JIC Swivel female 37° cone (90° Elbow)

Coude 90° femelle tournante cône JIC 37°

Femmina a 90° JIC 37°

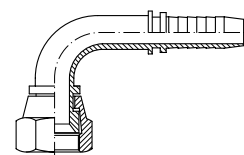

DN	THREAD ROSCA	Part n° Referencia	€
3/16"	7/16" 20h UNF	241380703	3,69
1/4"	7/16" 20h UNF	241380704	2,05
1/4"	1/2" 20h UNF	241380804	3,02
1/4"	9/16" 18h UNF	241380904	2,41
5/16"	9/16" 18h UNF	241380905	2,95
3/8"	9/16" 18h UNF	241380906	2,60
3/8"	5/8" 18h UNF	241381006	4,02
3/8"	3/4" 16h UNF	241381206	3,09
1/2"	3/4" 16h UNF	241381208	3,67
3/8"	7/8" 14h UNF	241381406	6,18
1/2"	7/8" 14h UNF	241381408	4,10
5/8"	7/8" 14h UNF	241381410	6,83
1/2"	1"1/16 12h UNF	241381708	9,67
5/8"	1"1/16 12h UNF	241381710	8,19
3/4"	1"1/16 12h UNF	241381712	7,29
3/4"	1"5/16 12h UNF	241382112	14,39
1"	1"5/16 12h UNF	241382116	12,50
1"	1"5/8 12h UNF	241382616	25,60
1"1/4"	1"5/8 12h UNF	241382620	24,57
1"1/4"	1"7/8 12h UNF	241383020	39,53
1"1/2"	1"7/8 12h UNF	241383024	35,55
2"	2"1/2 12h UNF	241384032	75,56

## Hembras giratorias 45° JIC 37°

JIC swivel female 37° cone (45° Elbow)

Coude 45° femelle tournante cône JIC 37°

Femmina a 45° JIC 37°

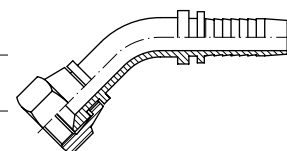

DN	THREAD ROSCA	Part n° Referencia	€
1/4"	7/16" 20h UNF	241390704	2,46
1/4"	1/2" 20h UNF	241390804	2,95
1/4"	9/16" 18h UNF	241390904	2,98
5/16"	9/16" 18h UNF	241390905	2,73
3/8"	9/16" 18h UNF	241390906	3,16
3/8"	3/4" 16h UNF	241391206	4,39
1/2"	3/4" 16h UNF	241391208	4,48
1/2"	7/8" 14h UNF	241391408	5,62
5/8"	7/8" 14h UNF	241391410	5,79
1/2"	1"1/16 12h UNF	241391708	9,35
5/8"	1"1/16 12h UNF	241391710	8,71
3/4"	1"1/16 12h UNF	241391712	7,55
3/4"	1"5/16 12h UNF	241392112	15,36
1"	1"5/16 12h UNF	241392116	13,34
1"	1"5/8 12h UNF	241392616	25,60
1"1/4"	1"5/8 12h UNF	241392620	28,65
1"1/4"	1"7/8 12h UNF	241393020	42,96
1"1/2"	1"7/8 12h UNF	241393024	42,96
2"	2"1/2 12h UNF	241394032	75,56

# Conexiones Standard

Standard series fittings  
Embouts série Standard  
Raccordi serie Standard

## Macho JIC 37°

Male JIC 37° cone

Mâle fixe JIC cône 37°

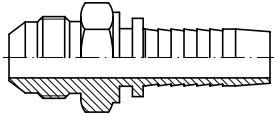

Maschio JIC 37°

DN	THREAD ROSCA	Part n° Referencia	€
1/4"	7/16" 20h UNF	241400704	1,15
1/4"	1/2" 20h UNF	241400804	2,05
5/16"	1/2" 20h UNF	241400805	1,90
1/4"	9/16" 18h UNF	241400904	1,51
5/16"	9/16" 18h UNF	241400905	1,62
3/8"	9/16" 18h UNF	241400906	1,40
3/8"	3/4" 16h UNF	241401206	1,91
1/2"	3/4" 16h UNF	241401208	2,11
3/8"	7/8" 14h UNF	241401406	2,72
1/2"	7/8" 14h UNF	241401408	2,48
5/8"	7/8" 14h UNF	241401410	2,81
1/2"	1"1/16 12h UNF	241401708	4,20
5/8"	1"1/16 12h UNF	241401710	3,81
3/4"	1"1/16 12h UNF	241401712	4,77
3/4"	1"5/16 12h UNF	241402112	7,61
1"	1"5/16 12h UNF	241402116	9,56
1"	1"5/8 12h UNF	241402616	15,56
1"1/4"	1"5/8 12h UNF	241402620	17,04
1"1/4"	1"7/8 12h UNF	241403020	24,04
1"1/2"	1"7/8 12h UNF	241403024	24,04
2"	2"1/2 12h UNF	241404032	44,51

## Espigas de prensar dobles

Double hose tail for crimping

Embout double jonction

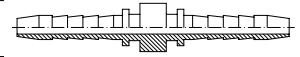

Giunzione tubo-tubo

DN	Part n° Referencia	€
1/4"	243000404	1,17
5/16"	243000505	1,69
3/8"	243000606	1,79
1/2"	243000808	2,22
3/4"	243001212	8,76
1"	243001616	12,87

## Machos Stecko

Stecko male connections

Mâle fixe Stecko

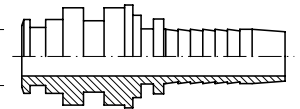

Maschio Stecko

DN	STECKO	Part n° Referencia	€
1/4"	1/4"	241900404	2,33
3/8"	3/8"	241900606	3,89
1/2"	1/2"	241900808	7,10
3/4"	3/4"	241901212	7,52



# Conexiones Standard

Standard series fittings  
Embouts série Standard  
Raccordi serie Standard

Hoses

Flexible hose fittings

Flow measuring

Processing machine  
for flexible hoses

## Hembras giratorias Métricas cono 24° con junta tórica

Metric swivel female 24° cone with o'ring

Femelle tournante droite Métrique cône 24°  
+ o'ring

Femmina Metrica sede 24° con o'ring

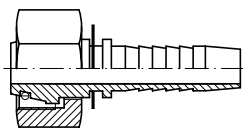

DN	PIPE TUBO	SERIE	THREAD ROSCA	Part nº Referencia	€
3/16"	6	L	12X1,5	24804120603	1,88
1/4"	6	L	12X1,5	24804120604	1,36
1/4"	8	L	14X1,5	24804140804	1,19
1/4"	10	L	16X1,5	24804161004	1,37
5/16"	10	L	16X1,5	24804161005	1,47
3/8"	10	L	16X1,5	24804161006	2,09
1/4"	12	L	18X1,5	24804181204	1,80
5/16"	12	L	18X1,5	24804181205	1,54
3/8"	12	L	18X1,5	24804181206	1,60
3/8"	15	L	22X1,5	24804221506	2,88
1/2"	15	L	22X1,5	24804221508	2,08
1/2"	18	L	26X1,5	24804261808	3,97
5/8"	18	L	26X1,5	24804261810	3,16
3/4"	22	L	30X2	24804302212	3,93
1"	28	L	36X2	24804362816	8,67
1 1/4"	35	L	45X2	24804453520	13,34
1 1/2"	42	L	52X2	24804524224	18,39
3/16"	8	S	16X1,5	24804160803	2,21
1/4"	8	S	16X1,5	24804160804	1,53
1/4"	10	S	18X1,5	24804181004	1,69
5/16"	12	S	20X1,5	24804201205	1,74
3/8"	12	S	20X1,5	24804201206	1,90
1/2"	12	S	20X1,5	24804201208	4,30
3/8"	14	S	22X1,5	24804221406	2,39
1/2"	16	S	24X1,5	24804241608	2,79
5/8"	20	S	30X2	24804302010	3,93
3/4"	20	S	30X2	24804302012	5,49
3/4"	25	S	36X2	24804362512	8,14
1"	25	S	36X2	24804362516	10,11
1"	30	S	42X2	24804423016	11,92
1 1/4"	38	S	52X2	24804523820	17,27

## Orientable Métrico Recto

Banjo metric

Banjo droit Métrique

Raccordo ad occhio Metrico

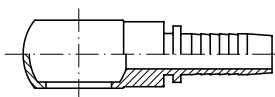

DN	Ø	Part nº Referencia	€
3/16"	M10x1	241161003	2,13
1/4"	M10x1	241161004	2,21
1/8"	M12x1	241161202 *	6,50
3/16"	M12x1.5	241161203	2,87
1/4"	M12x1.5	241161204	2,46
1/4"	M14x1.5	241161404	2,67
5/16"	M14x1.5	241161405	3,16
3/8"	M14x1.5	241161406	3,03
5/16"	M16x1.5	241161605	5,08
3/8"	M16x1.5	241161606	3,18
3/8"	M18x1.5	241161806	4,91
1/2"	M18x1.5	241161808	4,91
1/2"	M22x1.5	241162208	7,02
5/8"	M22x1.5	241162210	7,54
5/8"	M26x1.5	241162610	25,77
3/4"	M30x2	241163012	58,80

\*Hasta fin de existencias. / \*Until end of stock. / \*Jusqu'à la fin du stock. / \*Fino ad esaurimento scorta.

## Hembras giratorias 90° Métricas cono 24° con junta tórica

Metric swivel female 24° cone with o'ring  
Elbow

Coude 90° femelle tournante Métrique cône 24°  
+ o'ring

Femmina Metrica a 90° sede 24° con o'ring

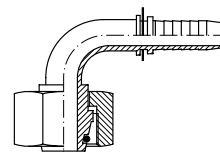

DN	PIPE TUBO	SERIE	THREAD ROSCA	Part nº Referencia	€
3/16"	6	L	12x1,5	24305120603	2,05
1/4"	6	L	12x1,5	24305120604	2,29
1/4"	8	L	14x1,5	24305140804	2,30
1/4"	10	L	16x1,5	24305161004	2,48
5/16"	10	L	16x1,5	24305161005	2,42
3/8"	10	L	16x1,5	24305161006	2,69
5/16"	12	L	18x1,5	24305181205	3,07
3/8"	12	L	18x1,5	24305181206	2,55
3/8"	15	L	22x1,5	24305221506	4,47
1/2"	15	L	22x1,5	24305221508	3,75
5/8"	18	L	26x1,5	24305261810	6,04
3/4"	22	L	30x2	24305302212	9,07
1"	28	L	36x2	24305362816	14,74
1 1/4"	35	L	45x2	24305453520	23,80
1 1/2"	42	L	52x2	24305524224	42,38
1/4"	8	S	16x1,5	24305160804	2,69
1/4"	10	S	18x1,5	24305181004	2,70
5/16"	10	S	18x1,5	24305181005	3,32
5/16"	12	S	20x1,5	24305201205	3,80
3/8"	12	S	20x1,5	24305201206	2,82
3/8"	14	S	22x1,5	24305221406	4,71
1/2"	16	S	24x1,5	24305241608	4,25
5/8"	20	S	30x2	24305302010	7,02
3/4"	20	S	30x2	24305302012	9,48
3/4"	25	S	36x2	24305362512	12,29
1"	25	S	36x2	24305362516	16,54
1"	30	S	42x2	24305423016	20,88
1 1/4"	38	S	52x2	24305523820	33,52

## Tornillo orientable simple rosca Métrica

Metric bolt for Banjo

Vis creuse simple pour banjo filetage métrique

Bullone forato Metrico

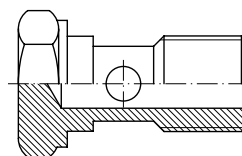

THREAD ROSCA	Part nº Referencia	€
M8x1	S109208	*
M10x1	S109210	*
M12x1.5	S109212	*
M14x1.5	S109214	*
M16x1.5	S109216	*
M18x1.5	S109218	*
M22x1.5	S109222	*
M26x1.5	S109226	*
M30x1.5	S109230	*

\*Ver precios en p.263 (ADAPTADORES BSP) / \*See prices in p.263 (BSP ADAPTORS) / \*Prix à la p.263 (ADAPTEURS BSP) / \*Vedere prezzi p.263 (ADATTATORI BSP)

# Conexiones Standard

Standard series fittings  
Embouts série Standard  
Raccordi serie Standard

## Hembras giratorias 45° Métricas cono 24° con junta tórica

Metric swivel female 24° cone with o'ring (45° Elbow)

Coude 45° femelle tournante Métrique cône 24° + o'ring

Femmina Metrica a 45° sede 24° con o'ring

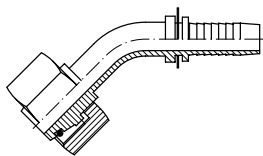

DN	PIPE TUBO	SERIE	THREAD ROSCA	Part nº Referencia	€
3/16"	6	L	12x1,5	24306120603	2,97
1/4"	6	L	12x1,5	24306120604	2,92
1/4"	8	L	14x1,5	24306140804	2,37
1/4"	10	L	16x1,5	24306161004	2,60
5/16"	10	L	16x1,5	24306161005	2,51
3/8"	10	L	16x1,5	24306161006	3,03
5/16"	12	L	18x1,5	24306181205	3,53
3/8"	12	L	18x1,5	24306181206	2,74
1/2"	15	L	22x1,5	24306221508	4,35
5/8"	18	L	26x1,5	24306261810	6,41
3/4"	22	L	30x2	24306302212	9,26
1"	28	L	36x2	24306362816	14,79
1 1/4"	35	L	45x2	24306453520	25,73
1 1/2"	42	L	52x2	24306524224	41,03
1/4"	8	S	16x1,5	24306160804	3,06
1/4"	10	S	18x1,5	24306181004	3,64
5/16"	12	S	20x1,5	24306201205	4,11
3/8"	12	S	20x1,5	24306201206	3,95
3/8"	14	S	22x1,5	24306221406	4,71
1/2"	16	S	24x1,5	24306241608	4,63
5/8"	20	S	30x2	24306302010	8,14
3/4"	20	S	30x2	24306302012	9,94
3/4"	25	S	36x2	24306362512	13,84
1"	25	S	36x2	24306362516	14,79
1"	30	S	42x2	24306423016	19,32
1 1/4"	38	S	52x2	24306523820	36,26

## Hembras giratorias rectas Komatsu cono 60°

Komatsu swivel female 60° cone

Femelle tournante droite Komatsu Métrique (cône 60°)

Femmina Komatsu sede 60°

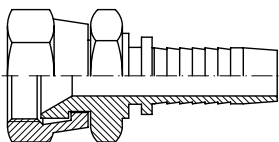

DN	THREAD ROSCA	Part nº Referencia	€
1/4"	M14X1.5	258049625	3,69
3/8"	M18X1.5	258049635	4,75
1/2"	M22X1.5	258049655	6,23
5/8"	M24X1.5	258049665	9,42
3/4"	M30X1.5	258049684	11,65
1"	M33X1.5	258049685	13,68

## Machos fijos Métricos cono 24°

Male stud Metric thread 24° cone

Mâle fixe Métrique cône 24°

Maschio Metrico sede 24°

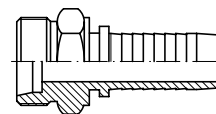

DN	PIPE TUBO	SERIE	THREAD ROSCA	Part nº Referencia	€
3/16"	6	L	12x1,5	24203120603	1,23
1/4"	6	L	12x1,5	24203120604	1,40
1/4"	8	L	14x1,5	24203140804	1,34
1/4"	10	L	16x1,5	24203161004	1,70
5/16"	10	L	16x1,5	24203161005	1,48
3/8"	10	L	16x1,5	24203161006	1,56
1/4"	12	L	18x1,5	24203181204	1,64
5/16"	12	L	18x1,5	24203181205	1,88
3/8"	12	L	18x1,5	24203181206	1,39
3/8"	15	L	22x1,5	24203221506	2,29
1/2"	15	L	22x1,5	24203221508	2,04
1/2"	18	L	26x1,5	24203261808	3,09
5/8"	18	L	26x1,5	24203261810	2,82
3/4"	22	L	30x2	24203302212	4,62
1"	28	L	36x2	24203362816	8,23
1 1/4"	35	L	45x2	24203453520	11,87
1 1/2"	42	L	52x2	24203524224	18,96
1/4"	8	S	16x1,5	24203160804	1,72
1/4"	10	S	18x1,5	24203181004	2,56
5/16"	10	S	18x1,5	24203181005	1,97
3/8"	10	S	18x1,5	24203181006	2,10
5/16"	12	S	20x1,5	24203201205	2,04
3/8"	12	S	20x1,5	24203201206	2,06
3/8"	14	S	22x1,5	24203221406	2,31
1/2"	16	S	24x1,5	24203241608	2,46
5/8"	20	S	30x2	24203302010	4,23
3/4"	20	S	30x2	24203302012	4,84
3/4"	25	S	36x2	24203362512	8,23
1"	25	S	36x2	24203362516	8,78
1"	30	S	42x2	24203423016	11,83
1 1/4"	38	S	52x2	24203523820	18,79

# Conexiones Standard

Standard series fittings  
Embouts série Standard  
Raccordi serie Standard

## Espiga lisa recta Métrica

Metric standpipe

Embout lisse droit Métrique

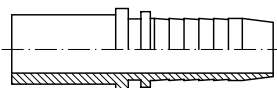

Estremitá tubolare diritta Metrica

DN	PIPE TUBO	Part n° Referencia	€
1/8"	6	241580602 L	2,77
3/16"	6	241580603 L	0,87
1/4"	6	241580604 L	0,82
3/16"	8	241580803 L	1,05
1/4"	8	241580804 L	0,79
5/16"	8	241580805 L	3,43
5/16"	10	241581005 L	1,42
3/8"	10	241581006 L	1,14
3/8"	12	241581206 L	1,11
1/2"	12	241581208 L	4,38
3/8"	15	241581506 L	1,58
1/2"	15	241581508 L	2,13
1/2"	18	241581808 L	1,96
5/8"	18	241581810 L	3,21
3/4"	22	241582212 L	6,44
1"	28	241582816 L	7,21
1"1/4	35	241583520 L	11,88
1"1/2	42	241584224 L	15,37
1/4"	10	241581004 S	0,98
1/4"	12	241581204 S	1,60
5/16"	12	241581205 S	1,60
3/8"	14	241581406 S	2,12
1/2"	14	241581408 S	2,67
1/2"	16	241581608 S	2,32
5/8"	20	241582010 S *	5,61
3/4"	20	241582012 S	4,08
1"	25	241582516 S	7,63
1"	30	241583016 S	7,32

\*Hasta fin de existencias. / \*Until end of stock. / \*Jusqu'à la fin du stock. / \*Hasta fin de existencias.

## Espiga lisa a 90° Métrica

Metric standpipe (90° Elbow)

Embout lisse coude 90° Métrique

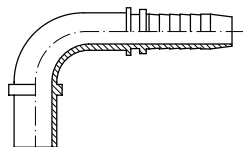

Estremitá tubolare a 90° Metrica

DN	PIPE TUBO	Part n° Referencia	€
1/8"	6	242580602 L	17,85
3/16"	6	242580603 L	1,34
1/4"	6	242580604 L	3,84
3/16"	8	242580803 L	7,77
1/4"	8	242580804 L	2,97
1/4"	12	242581204 L	9,39
3/8"	12	242581206 L	4,58
1/2"	15	242581508 L	7,15
5/8"	18	242581810 L	11,71
3/4"	22	242582212 L	11,21
1"	28	242582816 L	28,30
1"1/4	35	242583520 L *	37,39
1/4"	10	242581004 S	4,19

\*Hasta fin de existencias. / \*Until end of stock. / \*Jusqu'à la fin du stock. / \*Fino ad esaurimento scorta.

## Hembras giratorias Métricas cono 24°/60°

Female metric swivel 24°/60° cone

Femelle tournante Métrique cône 24°-60°

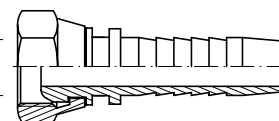

Femmina Metrica Girevole Multiseal 24°/60°

DN	PIPE TUBO	THREAD ROSCA	Part n° Referencia	€
1/4"	8L	M14X1.5	244049511	1,47
1/4"	10L	M16X1.5	244049520	1,76
5/16"	10L	M16X1.5	244049523	1,76
3/8"	10L	M16X1.5	244049524	1,99
5/16"	12L	M18X1.5	244049525	2,11
3/8"	12L	M18X1.5	244049535	2,11
3/8"	15L	M22X1.5	244049552	3,09
1/2"	15L	M22X1.5	244049555	3,40
5/8"	18L	M26X1.5	244049571	4,42

## Hembras giratorias 90° Métricas cono 24°/60°

Female metric swivel 24°/60° cone (90° Elbow)

Femelle tournante coude 90° Métrique cône 24°-60°

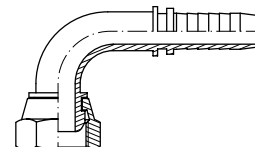

Femmina Metrica Girevole a 90° Multiseal 24°/60°

DN	PIPE TUBO	THREAD ROSCA	Part n° Referencia	€
1/4"	8L	M14X1.5	244059511	1,88
1/4"	10L	M16X1.5	244059520	2,24
5/16"	10L	M16X1.5	244059523	2,24
3/8"	10L	M16X1.5	244059524	2,51
5/16"	12L	M18X1.5	244059525	2,60
3/8"	12L	M18X1.5	244059535	2,60
3/8"	15L	M22X1.5	244059552	3,95
1/2"	15L	M22X1.5	244059555	4,38
5/8"	18L	M26X1.5	244059571	5,73

## Hembras giratorias 45° Métricas cono 24°/60°

Female metric swivel 24°/60° cone (45° Elbow)

Femelle tournante coude 45° Métrique cône 24°-60°

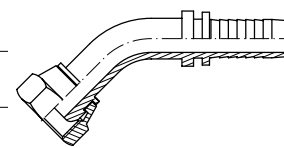

Femmina Metrica Girevole a 45° Multiseal 24°/60°

DN	PIPE TUBO	THREAD ROSCA	Part n° Referencia	€
1/4"	8L	M14X1.5	244069511	3,15
5/16"	10L	M16X1.5	244069523	3,36
3/8"	10L	M16X1.5	244069524	3,95
5/16"	12L	M18X1.5	244069525	3,95
3/8"	12L	M18X1.5	244069535	2,58
1/2"	15L	M22X1.5	244069555	5,66
5/8"	18L	M26X1.5	244069571	8,41

# Conexiones Standard

Standard series fittings  
Embouts série Standard  
Raccordi serie Standard

## Macho Métrico cono 24° serie francesa

*Metric stud 24° cone French Series*

Mâle fixe Série Française Métrique 24°

Maschio Metrico sede 24°

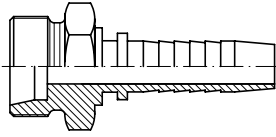

DN	PIPE TUBO	THREAD ROSCA	Part n° Referencia	€
1/4"	13.2	M20X1.5	245032013204	2,05
5/16"	13.2	M20X1.5	245032013205	1,76
3/8"	13.2	M20X1.5	245032013206	1,76
5/16"	16.7	M24X1.5	245032416705	3,07
3/8"	16.7	M24X1.5	245032416706	3,07
1/2"	16.7	M24X1.5	245032416708	3,07
5/8"	21.2	M30X1.5	245033021210	5,12
3/4"	21.2	M30X1.5	245033021212	5,12
3/4"	26.7	M36X1.5	245033626712	8,19
1"	33.5	M45X1.5	245034533516	13,31

## Macho Métrico válvula agrícola

*Metric stud for agricultural valve*

Mâle fixe Métrique pour valve agricole

Maschio Metrico per valvola agricola

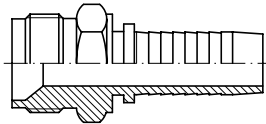

DN	THREAD ROSCA	Part n° Referencia	€
1/4"	M18X1.5	245051804	2,73
5/16"	M18X1.5	245051805	2,55
3/8"	M18X1.5	245051806	2,55

## Hembra giratoria recta Métrica cono 24° serie francesa

*Metric swivel female 24° cone French Series*

Femelle tournante Série Française Métrique 24°

Femmina Metrica sede 24°

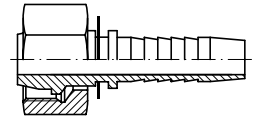

DN	PIPE TUBO	THREAD ROSCA	Part n° Referencia	€
1/4"	13.2	M20X1.5	245042013204	2,25
5/16"	13.2	M20X1.5	245042013205	2,29
3/8"	13.2	M20X1.5	245042013206	2,29
5/16"	16.7	M24X1.5	245042416705	3,60
3/8"	16.7	M24X1.5	245042416706	3,60
1/2"	16.7	M24X1.5	245042416708	3,60
5/8"	21.2	M30X1.5	245043021210	5,82
3/4"	26.7	M36X1.5	245043626712	9,26
1"	33.5	M45X1.5	245044533516	15,40

## Hembra giratoria 90° Métrica cono 24° serie francesa

*Metric swivel female 24° cone French Series (90° Elbow)*

Femelle tournante coude 90° Série Française Métrique 24°

Femmina Metrica a 90° sede 24°

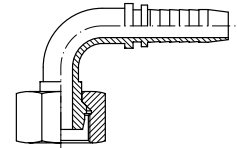

DN	PIPE TUBO	THREAD ROSCA	Part n° Referencia	€
5/16"	13.2	M20X1.5	245052013205	4,59
3/8"	13.2	M20X1.5	245052013206	4,59
1/2"	16.7	M24X1.5	245052416708	6,06
5/8"	21.2	M30X1.5	245053021210	11,30
3/4"	26.7	M36X1.5	245053626712	17,28

# Conexiones Standard

Standard series fittings  
Embouts série Standard  
Raccordi serie Standard

## Hembra giratoria recta ORFS asiento plano

ORFS Swivel female straight flat seat

Femelle tournante -ORFS fond plat

Femmina diritta sede piana ORFS

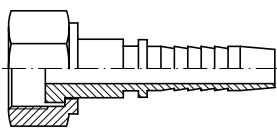

DN	THREAD ROSCA	Part nº Referencia	€
1/4"	9/16" 18h UNF	449000404	2,15
1/4"	11/16" 16h UNF	449000604	2,60
5/16"	11/16" 16h UNF	449000605	2,60
3/8"	11/16" 16h UNF	449000606	2,46
3/8"	13/16" 16h UNF	449000806	3,16
1/2"	13/16" 16h UNF	449000808	2,87
1/2"	1" 14h UNF	449001008	4,91
5/8"	1" 14h UNF	449001010	4,91
1/2"	1" 3/16 12h UNF	449001208	7,34
3/4"	1" 3/16 12h UNF	449001212	6,63
3/4"	1" 7/16 12h UNF	449001612	10,38
1"	1" 7/16 12h UNF	449001616	10,56
1"1/4"	1" 11/16 12h UNF	449002020	18,43
1"1/2"	2" 12h UNF	449002424	29,08

## Hembra giratoria 90° ORFS asiento plano

ORFS Swivel female flat seat (90° Elbow)

Femelle tournante coude 90° -ORFS fond plat

Femmina a 90° sede piana ORFS

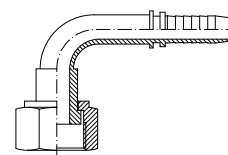

DN	THREAD ROSCA	Part nº Referencia	€
1/4"	9/16" 18h UNF	449070404	3,01
1/4"	11/16" 16h UNF	449070604	3,94
5/16"	11/16" 16h UNF	449070605	3,94
3/8"	11/16" 16h UNF	449070606	3,52
3/8"	13/16" 16h UNF	449070806	5,32
1/2"	13/16" 16h UNF	449070808	4,92
1/2"	1-14h UNF	449071008	8,15
5/8"	1" 14h UNF	449071010	8,15
1/2"	1" 3/16-12h UNF	449071208	11,25
3/4"	1" 3/16 12h UNF	449071212	10,07
3/4"	1" 7/16 12h UNF	449071612	17,69
1"	1" 7/16 12h UNF	449071616	17,69
1"1/4"	1" 11/16 12h UNF	449072020	32,10
1"1/2"	2" 12h UNF	449072424	44,93

## Machos ORFS asiento plano con junta tórica

ORFS Male flat seat + o'ring

Mâle fixe -ORFS fond plat + o'ring

Maschio ORFS sede piana con o'ring

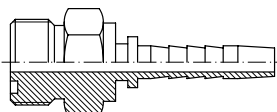

DN	THREAD ROSCA	Part nº Referencia	€
1/4"	9/16" 18h UNF	449120404	1,95
1/4"	11/16" 16h UNF	449120604	2,50
5/16"	11/16" 16h UNF	449120605	2,50
3/8"	11/16" 16h UNF	449120606	2,63
3/8"	13/16" 16h UNF	449120806	3,50
1/2"	13/16" 16h UNF	449120808	3,50
1/2"	1" 14h UNF	449121008	4,73
5/8"	1" 14h UNF	449121010	4,73
1/2"	1" 3/16 12h UNF	449121208	7,39
3/4"	1" 3/16 12h UNF	449121212	7,39
3/4"	1" 7/16 12h UNF	449121612	13,90
1"	1" 7/16 12h UNF	449121616	13,90
1"1/4"	1" 11/16-12h UNF	449122020	20,62

## Hembra giratoria 45° ORFS asiento plano

ORFS Swivel female (45° Elbow) flat seat

Femelle tournante coude 45° -ORFS fond plat

Femmina a 45° sede piana ORFS

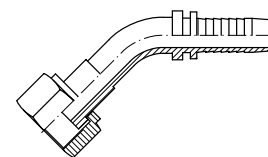

DN	THREAD ROSCA	Part nº Referencia	€
1/4"	11/16" 16h UNF	449080604	3,94
5/16"	11/16" 16h UNF	449080605	3,94
1/2"	1" 3/16 12h UNF	449081208	11,25
3/4"	1" 7/16 12h UNF	449081612	17,69
1/4"	9/16" 18h UNF	449080404	3,28
3/8"	11/16" 16h UNF	449080606	3,79
3/8"	13/16" 16h UNF	449080806	5,37
1/2"	13/16" 16h UNF	449080808	5,00
1/2"	1" - 14h UNF	449081008	8,19
5/8"	1" 14h UNF	449081010	8,11
3/4"	1" 3/16 12h UNF	449081212	12,20
1"	1" 7/16 12h UNF	449081616	20,48
1"1/4"	1" 11/16 12h UNF	449082020	29,69
1"1/2"	2" 12h UNF	449082424	44,93

## Juntas tóricas para ORFS

O' rings for ORFS

O' rings pour ORFS

O'rings per raccordi ORFS



Ø INNER Ø INT.	Thickness (mm) Espesor (mm)	Part nº Referencia	€
7,65	1,78	7.65X1.78	0,06
9,25	1,78	9.25X1.78	0,07
12,42	1,78	12.42X1.78	0,08
15,60	1,78	15.60X1.78	0,10
18,77	1,78	18.77X1.78	0,12
23,52	1,78	23.52X1.78	0,15
29,87	1,78	29.87X1.78	0,20
37,82	1,78	37.82X1.78	0,26

# Conexiones Standard

Standard series fittings  
Embouts série Standard  
Raccordi serie Standard

## Brida recta SAE 3000 PSI

3000 PSI SAE Straight Flange / Code 61

Bride SAE droite série 3000 PSI

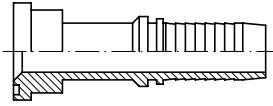

Flangia diritta SAE 3000 PSI

DN	Ø	Part n° Referencia	€
1/2"	30.2	241820808	5,23
1/2"	38.1	241821208	7,99
5/8"	38.1	241821210	9,06
3/4"	38.1	241821212	8,29
3/4"	44.5	241821612	11,27
1"	44.5	241821616	11,36
1"	50.8	241822016	16,41
1"1/4	50.8	241822020	16,73
1"1/4	60.3	241822420	24,61
1"1/2	60.3	241822424	24,83
1"1/2	71.4	241823224	45,81
2"	71.4	241823232	41,64

## Brida recta SAE 6000 PSI

6000 PSI SAE Straight Flange / Code 62

Bride SAE droite série 6000 PSI

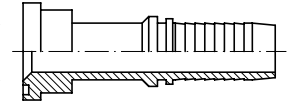

Flangia diritta SAE 6000 PSI

DN	Ø	Part n° Referencia	€
1/2"	31.8	242820808	6,18
1/2"	41.3	242821208	9,06
5/8"	41.3	242821210	9,59
3/4"	41.3	242821212	10,44
3/4"	47.6	242821612	14,70
1"	47.6	242821616	15,13
1"	54	242822016	20,03
1"1/4	54	242822020	21,09
1"1/4	63.5	242822420	30,68
1"1/2	63.5	242822424	32,49
1"1/2	79.4	242823224	64,00
2"	79.4	242823232	60,84

## Brida a 90° SAE 3000 PSI

3000 PSI SAE Flange (90° Elbow) / Code 61

Bride SAE coude 90° série 3000 PSI

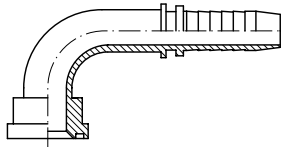

Flangia a 90° SAE 3000 PSI

DN	Ø	Part n° Referencia	€
1/2"	30.2	241830808	7,23
1/2"	38.1	241831208	10,35
5/8"	38.1	241831210	10,35
3/4"	38.1	241831212	10,35
3/4"	44.5	241831612	16,54
1"	44.5	241831616	16,54
1"	50.8	241832016	23,24
1"1/4	50.8	241832020	23,24
1"1/4	60.3	241832420	34,85
1"1/2	60.3	241832424	38,07
1"1/2	71.4	241833224	80,63
2"	71.4	241833232	74,58

## Brida a 90° SAE 6000 PSI

6000 PSI SAE Flange (90° Elbow) / Code 62

Bride SAE coude 90° série 6000 PSI

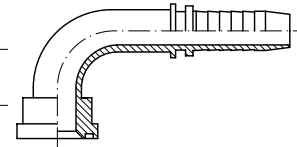

Flangia a 90° SAE 6000 PSI

DN	Ø	Part n° Referencia	€
1/2"	31.8	242830808	7,87
1/2"	41.3	242831208	11,77
5/8"	41.3	242831210	10,91
3/4"	41.3	242831212	10,91
3/4"	47.6	242831612	18,70
1"	47.6	242831616	18,70
1"	54	242832016	26,27
1"1/4	54	242832020	26,27
1"1/4	63.5	242832420	43,09
1"1/2	63.5	242832424	39,85
1"1/2	79.4	242833224	78,83

## Brida a 45° SAE 3000 PSI

3000 PSI SAE Flange (45° Elbow) / Code 61

Bride SAE coude 45° série 3000 PSI

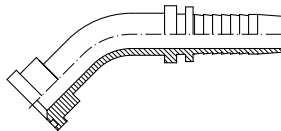

Flangia a 45° SAE 3000 PSI

DN	Ø	Part n° Referencia	€
1/2"	30.2	241840808	7,23
1/2"	38.1	241841208	10,35
5/8"	38.1	241841210	10,35
3/4"	38.1	241841212	10,35
3/4"	44.5	241841612	16,54
1"	44.5	241841616	16,54
1"	50.8	241842016	23,24
1"1/4	50.8	241842020	23,24
1"1/4	60.3	241842420	37,66
1"1/2	60.3	241842424	38,07
1"1/2	71.4	241843224	78,83
2"	71.4	241843232	74,58

## Brida a 45° SAE 6000 PSI

6000 PSI SAE Flange (45° Elbow) / Code 62

Bride SAE coude 45° série 6000 PSI

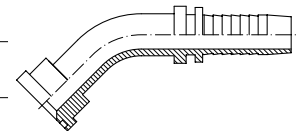

Flangia a 45° SAE 6000 PSI

DN	Ø	Part n° Referencia	€
1/2"	31.8	242840808	7,87
1/2"	41.3	242841208	11,77
5/8"	41.3	242841210	10,91
3/4"	41.3	242841212	10,91
3/4"	47.6	242841612	18,70
1"	47.6	242841616	18,70
1"	54	242842016	26,27
1"1/4	54	242842020	26,27
1"1/4	63.5	242842420	43,09
1"1/2	63.5	242842424	39,85
1"1/2	79.4	242843224	78,83
2"	79.4	242843232	78,83

# Conexiones Standard

Standard series fittings  
Embouts série Standard  
Raccordi serie Standard

Hoses

Flexible hose fittings

Flow measuring

Processing machine  
for flexible hoses

## Brida recta 9000 PSI (14,3)

9000 PSI straight Flange (14,3)

Bride tournante droite série 9000 PSI (14,3)

Flangia diritta PSI 9000 (14,3)

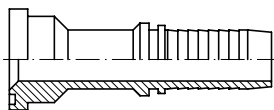

DN	Ø	Part n° Referencia	€
3/4"	41,3	442821212	11,77
3/4"	47,6	442821612	19,06
1"	47,6	442821616	19,06
1"	54	442822016	23,83
1"1/4	54	442822020	23,83
1"1/2	63,5	442822424	41,53

## Brida a 90° 9000 PSI (14,3)

9000 PSI 90° Flange (14,3)

Bride tournante coude 90° série 9000 PSI (14,3)

Flangia a 90° PSI 9000 (14,3)

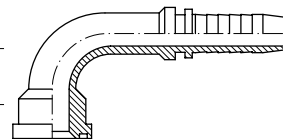

DN	Ø	Part n° Referencia	€
3/4"	41,3	442831212	15,17
3/4"	47,6	442831612	23,83
1"	47,6	442831616	23,83
1"	54	442832016	33,07
1"1/4	54	442832020	33,07
1"1/2	63,5	442832424	41,53

## Brida a 45° 9000 PSI (14,3)

9000 PSI 45° Flange (14,3)

Bride tournante coude 45° série 9000 PSI (14,3)

Flangia a 45° PSI 9000 (14,3)

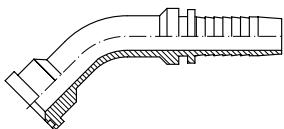

DN	Ø	Part n° Referencia	€
3/4"	41,3	442841212	15,17
3/4"	47,6	442841612	23,83
1"	47,6	442841616	23,83
1"	54	442842016	33,07
1"1/4	54	442842020	33,07
1"1/2	63,5	442842424	41,53

# Conexiones Standard

Standard series fittings  
Embouts série Standard  
Raccordi serie Standard

## Bridas SAE partidas (semibridas) 3000/6000 PSI

3000/6000 PSI SAE Split flanges

Demi-bridés rectangulaires de fixation SAE  
3000/6000 PSI

Semiflangua SAE 3000/6000 PSI

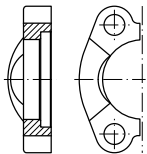

SERIE	SIZE TAMAÑO	Part n° Referencia	€
3000 PSI	1/2"	<b>BBP308</b>	<b>6,60</b>
3000 PSI	3/4"	<b>BBP312</b>	<b>7,48</b>
3000 PSI	1"	<b>BBP316</b>	<b>6,97</b>
3000 PSI	1"1/4	<b>BBP320</b>	<b>9,11</b>
3000 PSI	1"1/2	<b>BBP324</b>	<b>12,02</b>
3000 PSI	2"	<b>BBP332</b>	<b>15,92</b>
3000 PSI	2"1/2	<b>BBP340</b>	<b>32,30</b>
3000 PSI	3"	<b>BBP348</b>	<b>39,62</b>
3000 PSI	3"1/2	<b>BBP356</b>	<b>45,30</b>
3000 PSI	4"	<b>BBP364</b>	<b>62,50</b>
6000 PSI	1/2"	<b>BBP608</b>	<b>5,55</b>
6000 PSI	3/4"	<b>BBP612</b>	<b>8,57</b>
6000 PSI	1"	<b>BBP616</b>	<b>13,09</b>
6000 PSI	1"1/4	<b>BBP620</b>	<b>20,51</b>
6000 PSI	1"1/2	<b>BBP624</b>	<b>32,60</b>
6000 PSI	2"	<b>BBP632</b>	<b>48,52</b>

## Bridas SAE enteras (monoblock) 3000/6000 PSI

3000/6000 PSI SAE Flanges

Bridés monobloc rectangulaires de fixation SAE  
3000/6000 PSI

Flangua SAE 3000/6000 PSI

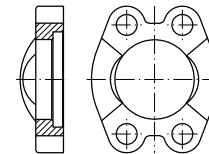

SERIE	SIZE TAMAÑO	Part n° Referencia	€
3000 PSI	1/2"	<b>BBE308</b>	<b>4,84</b>
3000 PSI	3/4"	<b>BBE312</b>	<b>6,34</b>
3000 PSI	1"	<b>BBE316</b>	<b>7,22</b>
3000 PSI	1"1/4	<b>BBE320</b>	<b>9,07</b>
3000 PSI	1"1/2	<b>BBE324</b>	<b>12,23</b>
3000 PSI	2"	<b>BBE332</b>	<b>16,02</b>
3000 PSI	2"1/2	<b>BBE340</b>	<b>28,25</b>
3000 PSI	3"	<b>BBE348</b>	<b>39,62</b>
3000 PSI	3"1/2	<b>BBE356</b>	<b>45,30</b>
3000 PSI	4"	<b>BBE364</b>	<b>62,50</b>
3000 PSI	5"	<b>BBE380</b>	<b>79,23</b>
6000 PSI	1/2"	<b>BBE608</b>	<b>5,37</b>
6000 PSI	3/4"	<b>BBE612</b>	<b>8,71</b>
6000 PSI	1"	<b>BBE616</b>	<b>13,29</b>
6000 PSI	1"1/4	<b>BBE620</b>	<b>17,69</b>
6000 PSI	1"1/2	<b>BBE624</b>	<b>29,22</b>
6000 PSI	2"	<b>BBE632</b>	<b>45,94</b>

## Junta tórica para brida SAE 3000/6000 PSI

O'rings for 3000/6000 PSI SAE flanges

O'rings pour bride série 3000/6000 PSI

O'rings per flangua SAE 3000/6000 PSI



Ø INNER Ø INT.	SIZE TAMAÑO	Thickness (mm) Espesor (mm)	UNITS PER BAG CANTIDAD / BOLSA	Part n° Referencia	€
18.64	1/2"	3.53	1	<b>18.64X3.53</b>	<b>0,19</b>
24.99	3/4"	3.53	1	<b>24.99X3.53</b>	<b>0,25</b>
32.92	1"	3.53	1	<b>32.92X3.53</b>	<b>0,32</b>
37.70	1"1/4	3.53	1	<b>37.70X3.53</b>	<b>0,38</b>
47.22	1"1/2	3.53	1	<b>47.22X3.53</b>	<b>0,49</b>
56.74	2"	3.53	1	<b>56.74X3.53</b>	<b>0,60</b>

## Juntas para bridas SAE 3000/6000 PSI

Seals for 3000/6000 PSI flange

Joints pour bride série 3000/6000

Guarnizioni per flangua SAE 3000/6000 PSI



Ø OUTER Ø EXT.	Ø INNER Ø INT.	SIZE TAMAÑO	HEIGHT (MM) ALTURA (MM)	Part n° Referencia	€
25.40	17.02	1/2"	2.79	<b>JBR08</b>	<b>0,75</b>
31.72	23.36	3/4"	2.79	<b>JBR12</b>	<b>0,92</b>
39.62	31.24	1"	2.79	<b>JBR16</b>	<b>1,16</b>
44.45	36.07	1"1/4	2.79	<b>JBR20</b>	<b>1,41</b>
53.98	45.34	1"1/2	2.79	<b>JBR24</b>	<b>1,83</b>
63.50	54.86	2"	2.79	<b>JBR32</b>	<b>2,08</b>

## Tornillos para bridas SAE

Screws for SAE flanges

Vis pour bridas SAE

Vite per flangua SAE



THREAD ROSCA	SIZE TAMAÑO	Part n° Referencia	€
M8X30	3000-6000 PSI 1/2"	<b>TB8X30</b>	<b>0,17</b>
M10X35	3000 PSI 3/4"-1"	<b>TB10X35</b>	<b>0,32</b>
M10X40	3000 PSI 1" 1/4 - 6000 PSI 3/4"	<b>TB10X40</b>	<b>0,33</b>
M12X35	3000 PSI 1"1/2-2"-2"1/2-6000 PSI 1"	<b>TB12X35</b>	<b>0,50</b>
M14X45	6000 PSI 1"1/4	<b>TB14X45</b>	<b>0,82</b>
M16X50	3000 PSI 3"-3"1/2"-4"- 6000 PSI 1" 1/2	<b>TB16X50</b>	<b>1,21</b>
M20X70	6000 PSI 2"	<b>TB20X70</b>	<b>1,85</b>



# Conexiones Standard

Standard series fittings  
Embouts série Standard  
Raccordi serie Standard

## Espiga para brida macho Poclair

Poclair male flange

Embout bride mâle Poclair

Inserto per flangia maschio Poclair

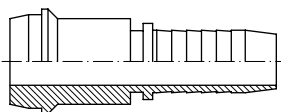

DN	Ø	Part n° Referencia	€
5/8"	5/8"	448011010	14,04
3/4"	3/4"	448011212	11,84

Hasta fin existencias. \*Ver p.59 (Conexiones Interlock) / Until end of stock. \*See p.59 (Interlock Fittings) / Jusqu'à la fin du stock. \*Voir p.59 (Interlock) / Fino ad esaurimento scorta. \*Vedere p.59 (Interlock)

## Espiga a 90° brida macho Poclair

90° Poclair female flange standpipe

Embout bride coude 90° macho Poclair

Inserto per flangia a 90° Poclair

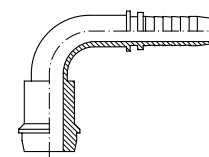

DN	Ø	Part n° Referencia	€
1/2"	1/2"	448030808	21,66
1"1/4	1"1/4	448032020	59,80

Hasta fin existencias. / Until end of stock. / Jusqu'à la fin du stock. / Fino ad esaurimento scorta.

## Brida entera macho Poclair 4 agujeros

Male Poclair flange 4 holes

Bride rectangulaire de fixation mâle Poclair-4 trous

Flangia intera maschio Poclair 4 fori

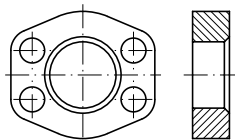

SIZE TAMAÑO	Part n° Referencia	€
1/2"	448050808 *	15,23
3/4"	448051212	26,99
1"	448051616	32,18
1"1/4	448052020	42,75

\*Hasta fin de existencias. / \*Until end of stock. / \*Jusqu'à la fin du stock. / \*Fino ad esaurimento scorta.

## Brida entera hembra Poclair 4 agujeros

Female Poclair flange 4 holes

Bride rectangulaire de fixation femelle Poclair 4 trous

Flangia intera femmina Poclair 4 fori

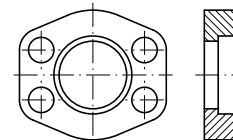

SIZE TAMAÑO	Part n° Referencia	€
1/2"	448060808 *	15,23
3/4"	448061212	42,42
1"	448061616	48,25
1"1/4	448062020	60,21

\*Hasta fin de existencias. / \*Until end of stock. / \*Jusqu'à la fin du stock. / \*Fino ad esaurimento scorta.

## Brida entera macho Poclair 2 agujeros

Male Poclair flange 2 holes

Bride ovale fixation mâle Poclair 2 trous

Flangia intera maschio Poclair 2 fori

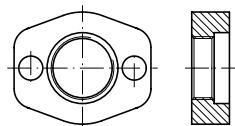

PIPE TUBO	Part n° Referencia	€
5/8"	448071010	22,45
3/4"	448071212	24,45
1"	448071616	29,51
1"1/4	448072020	47,01

## Brida entera hembra Poclair 2 agujeros

Female Poclair flange 2 holes

Bride ovale fixation femelle Poclair 2 trous

Flangia intera femmina Poclair 2 fori

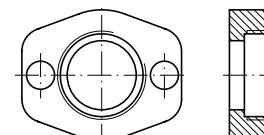

PIPE TUBO	Part n° Referencia	€
5/8"	448081010	18,21
1"	448081616	23,03
1"1/4	448082020	25,05

Hasta fin de existencias. / Until end of stock. / Jusqu'à la fin du stock. / Fino ad esaurimento scorta.

# Conexiones Standard

Standard series fittings  
Embouts série Standard  
Raccordi serie Standard

## Macho pistola hidrolavadora

Male terminal steel hydro-wash

Mâle fixe spécial pistolet-hydronetoyage



Maschio pistola idropulitrice

DN	Part n° Referencia	€
1/4"	<b>230400400</b>	<b>1,61</b>

## Empuñaduras de goma negras

Handle with black rubber

Poignée hydronetoyage de gomme noire

Manopola di gomma nera



DN	Ø OUTER Ø EXT.	Ø INNER Ø INT.	Part n° Referencia	€
1/4"	29	15,5	<b>230600400</b>	<b>1,39</b>
5/16"	35	18	<b>230600500</b>	<b>1,78</b>
3/8"	35	21	<b>230600600</b>	<b>1,61</b>

## Empuñaduras de goma grises

Handle with grey rubber

Poignée hydronetoyage de gomme grise

Manopola di gomma grigia



DN	Ø OUTER Ø EXT.	Ø INNER Ø INT.	Part n° Referencia	€
1/4"	29	15,5	<b>230610400</b>	<b>2,11</b>
5/16"	35	18	<b>230610500</b>	<b>2,72</b>
3/8"	35	22	<b>230610600</b>	<b>2,39</b>

## Terminal Karcher acero

Swivel female steel hydro-wash

Embout femelle tournante acier spécial  
hydronetoyage

Femmina in acciaio per idropulitrici

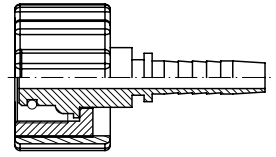

PIPE TUBO	THREAD ROSCA	DESCRIPTION DESCRIPCIÓN	Part n° Referencia	€
1/4"	M22X1.5	STD	<b>230700400</b>	<b>4,70</b>
5/16"	M22X1.5	STD	<b>230700500</b>	<b>4,48</b>
3/8"	M22X1.5	STD	<b>230700600</b>	<b>4,70</b>
1/4"	M22X1.5	Long	<b>230720400</b>	<b>4,82</b>
5/16"	M22X1.5	Long	<b>230720500</b>	<b>4,61</b>
3/8"	M22X1.5	Long	<b>230720600</b>	<b>4,82</b>

## Empuñaduras de goma azules

Handle with blue rubber

Poignée hydronetoyage de gomme bleue

Manopola di gomma azzurra



DN	Ø OUTER Ø EXT.	Ø INNER Ø INT.	Part n° Referencia	€
1/4"	29	15,5	<b>230620400</b>	<b>2,17</b>
5/16"	35	18	<b>230620500</b>	<b>2,72</b>
3/8"	35	21	<b>230620600</b>	<b>2,39</b>

# Conexiones Serie BW no pelar R12 / 4SP / 4SH

BW fittings - no skiving R12 / 4SP / 4SH

Embouts BW sans dénuder R12 / 4SP / 4SH

Raccordi BW - 2 pezzi R12 / 4SP / 4SH

## Casquillos compactos serie BW

Ferrules for fittings BW series

Jupes pour embouts série BW

Boccole pressare per raccordi serie BW

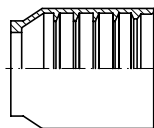

DN	Part n° Referencia	€
3/4"	AC680101200	7,91
1"	AC680101600	11,60
1" 1/4	AC680102000	18,68

## Hembras giratorias rectas BSP cono 60° con junta

BSP Swivel female 60° cone with o'ring

Femelle tournante gaz cyl BSP 60° avec joint

Femmina diritta BSP sede 60° con giunta

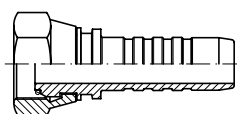

DN	THREAD ROSCA	Part n° Referencia	€
3/4"	3/4" BSP	661101212	5,76
1"	1" BSP	661101616	10,12
1" 1/4	1" 1/4 BSP	661102020	16,38

## Hembras giratorias 90° BSP cono 60° con junta

BSP Swivel female 60° cone with joint (90° Elbow)

Coude 90° femelle tournante gaz cyl BSP 60° avec joint

Femmina a 90° BSP sede 60° con giunta

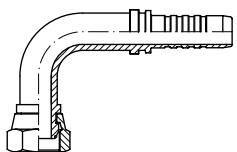

DN	THREAD ROSCA	Part n° Referencia	€
3/4"	3/4" BSP	661171212	11,51
1"	1" BSP	661171616	18,22
1" 1/4	1" 1/4 BSP	661172020	30,28

## Macho JIC 37°

JIC 37° male

Mâle JIC 37°

Maschio JIC 37°

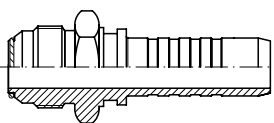

DN	THREAD ROSCA	Part n° Referencia	€
3/4"	1"1/16 12h UNF	661401712	5,31
1"	1"5/16 12h UNF	661402116	9,74

## Hembras giratorias rectas JIC 37° doble hexagonal

JIC 37° Swivel female doble hexagonal

Femelle JIC 37° double hexagonale

Femmina diritta JIC 37° doppio esagono

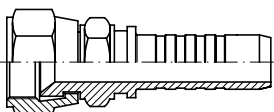

DN	THREAD ROSCA	Part n° Referencia	€
3/4"	1"1/16 12h UNF	662421712	7,08
1"	1"5/16 12h UNF	662422116	10,63

## Hembras giratorias 45° BSP cono 60° con junta

BSP Swivel female 60° cone with joint (45° Elbow)

Coude 45° femelle tournante gaz cyl BSP 60° avec joint

Femmina a 45° BSP sede 60° con giunta

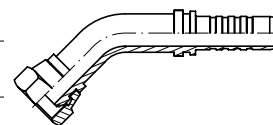

DN	THREAD ROSCA	Part n° Referencia	€
3/4"	3/4" BSP	661181212	11,51
1"	1" BSP	661181616	18,22
1" 1/4	1" 1/4 BSP	661182020	35,32

## Macho BSP cono 60°

BSP Male 60° cone

Mâle BSP cône 60°

Maschio BSP 60°

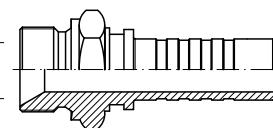

DN	THREAD ROSCA	Part n° Referencia	€
3/4"	3/4" BSP	661121212	6,64
3/4"	3/4" BSP	661121616	10,63
3/4"	3/4" BSP	661122020	18,98

## Hembras giratorias 90° JIC 37°

JIC 37° swivel female (90° Elbow)

Coude 90° femelle JIC 37°

Femmina gir. 90° JIC 37°

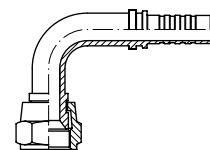

DN	THREAD ROSCA	Part n° Referencia	€
3/4"	1"1/16 12h UNF	661381712	11,65
1"	1"5/16 12h UNF	661382116	18,22

## Hembras giratorias 45° JIC 37°

JIC 37° swivel female (45° Elbow)

Coude 45° femelle JIC 37°

Femmina gir. 45° JIC 37°

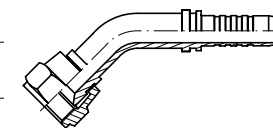

DN	THREAD ROSCA	Part n° Referencia	€
3/4"	1"1/16 12h UNF	661391712	11,65
1"	1"5/16 12h UNF	661392116	18,22

# Conexiones Serie BW no pelar R12 / 4SP / 4SH

BW fittings - no skiving R12 / 4SP / 4SH

Embouts BW sans dénuder R12 / 4SP / 4SH

Raccordi BW - 2 pezzi R12 / 4SP / 4SH

## Hembras giratorias Métricas cono 24° con junta tórica

Metric swivel female 24° seat with o'ring

Femelle Métrique 24° avec o'ring

Femmina Metrica sede 24° con o'ring

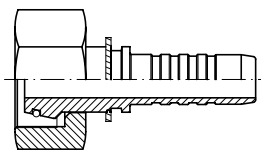

DN	THREAD ROSCA	Part n° Referencia	€
3/4"	M36X2	66204362512	10,78
1"	M42X2	66204423016	15,50
1"1/4	M52X2	66204523820	23,91

## Hembras giratorias 90° Métricas cono 24° con junta tórica

Metric swivel female 24° seat with o'ring (90° Elbow)

Coude 90° femelle Métrique 24° avec o'ring

Femmina Metrica 90° sede 24° con o'ring

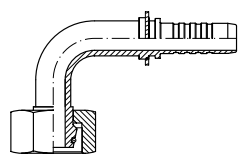

DN	THREAD ROSCA	Part n° Referencia	€
3/4"	M36X2	66205362512	15,50
1"	M42X2	66205423016	24,29
1"1/4	M52X2	66205523820	40,48

## Brida recta SAE 3000 PSI

3000 PSI SAE Straight flange

Bride SAE droite série 3000 PSI

Flangia diritta SAE 3000



DN	Ø	Part n° Referencia	€
3/4"	38.1	661821212	9,55
1"	44.5	661821616	12,97
1"1/4	50.8	661822020	21,47

## Brida a 90° SAE 3000 PSI

3000 PSI SAE 90° Flange

Bride SAE coude 90° série 3000 PSI

Flangia 90° SAE 3000

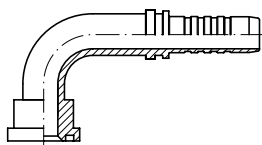

DN	Ø	Part n° Referencia	€
3/4"	38.1	661831212	14,46
1"	44.5	661831616	19,81
1"1/4	50.8	661832020	31,12

## Brida a 45° SAE 3000 PSI

3000 PSI SAE 45° Flange

Bride SAE coude 45° série 3000 PSI

Flangia 45° SAE 3000

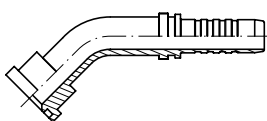

DN	Ø	Part n° Referencia	€
3/4"	38.1	661841212	14,46
1"	44.5	661841616	19,81
1"1/4	50.8	661842020	31,12

## Hembras giratorias 45° Métricas cono 24° con junta tórica

Metric swivel female 24° seat with o'ring (45° Elbow)

Coude 45° femelle Métrique 24° avec o'ring

Femmina Metrica 45° sede 24°

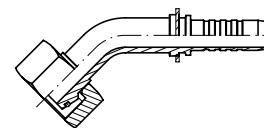

DN	THREAD ROSCA	Part n° Referencia	€
3/4"	M36X2	66206362512	15,50
1"	M42X2	66206423016	21,25
1"1/4	M52X2	66206523820	40,48

## Machos fijos Métricos cono 24°

Metric male stud 24° cone

Mâle Métrique cone 24°

Maschio Metrico sede 24° con o'ring

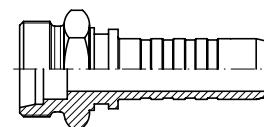

DN	THREAD ROSCA	Part n° Referencia	€
3/4"	M36X2	66203362512	9,74
1"	M42X2	66203423016	14,17

## Brida recta SAE 6000 PSI

6000 PSI SAE Straight flange

Bride SAE droite série 6000 PSI

Flangia diritta SAE 6000

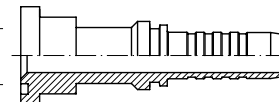

DN	Ø	Part n° Referencia	€
3/4"	41,3	662821212	10,69
1"	47,63	662821616	14,28
1"1/4	53,98	662822020	23,23

## Brida a 90° SAE 6000 PSI

6000 PSI SAE 90° Flange

Bride SAE coude 90° série 6000 PSI

Flangia 90° SAE 6000

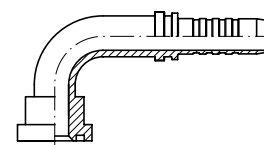

DN	Ø	Part n° Referencia	€
3/4"	41.3	662831212	15,86
1"	47.6	662831616	21,83
1"1/4	54	662832020	33,22

## Brida a 45° SAE 6000 PSI

6000 PSI SAE 45° flange

Bride SAE coude 45° série 6000 PSI

Flangia 45° SAE 6000

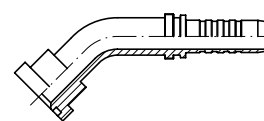

DN	Ø	Part n° Referencia	€
3/4"	41,3	662841212	15,86
1"	47,6	662841616	21,83
1"1/4	54	662842020	33,22

# Conexiones Serie BW no pelar R12 / 4SP / 4SH

*BW fittings - no skiving R12 / 4SP / 4SH*

*Embouts BW sans dénuder R12 / 4SP / 4SH*

*Raccordi BW - 2 pezzi R12 / 4SP / 4SH*

Hoses

Flexible hose fittings

Flow measuring

Processing machine  
for flexible hoses

## Hembra giratoria recta ORFS asiento plano doble hexagonal

*ORFS Swivel female straight double hexagonal*

*Femelle droite ORFS double hexagonale*

*Femmina diritta ORFS doppio esagono*

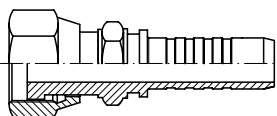

PIPE TUBO	THREAD ROSCA	Part n° Referencia	€
3/4"	1"3/16 12h UNF	<b>669011212</b>	<b>8,06</b>
1"	1"7/16 12h UNF	<b>669011616</b>	<b>12,71</b>

## Hembra giratoria 90° ORFS asiento plano

*ORFS Swivel female (90° Elbow)*

*Coude 90° femelle ORFS*

*Femmina 90° ORFS*

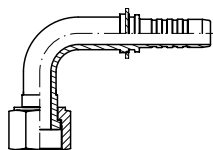

PIPE TUBO	THREAD ROSCA	Part n° Referencia	€
3/4"	1"3/16 12h UNF	<b>669071212</b>	<b>12,18</b>
1"	1"7/16 12h UNF	<b>669071616</b>	<b>18,22</b>

## Hembra giratoria 45° ORFS asiento plano

*ORFS Swivel female (45° Elbow)*

*Coude 45° femelle ORFS*

*Femmina 45° ORFS*

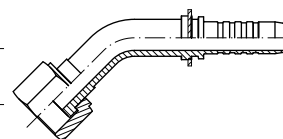

PIPE TUBO	THREAD ROSCA	Part n° Referencia	€
3/4"	1"3/16 12h UNF	<b>669081212</b>	<b>12,18</b>
1"	1"7/16 12h UNF	<b>669081616</b>	<b>18,22</b>

# Conexiones Interlock

Interlock series fittings  
Embouts à sertir Interlock  
Raccordi serie Interlock

## Casquillos 4SH

Ferrules DIN 20023-4SH

Jupe à sertir DIN 20023 4SH

Boccola Interlock 4SH

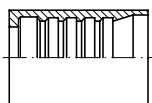

DN	DESCRIPTION DESCRIPCIÓN	Part n° Referencia	€
3/4"	4SH / R13 / R15	A610101200	6,78
1"	4SH / R13 / R15	A610101600	11,58
1"1/4	4SH	A610102000	18,69
1"1/2	4SH	A610102400	23,60
2"	4SH	A610103200	42,90

## Casquillos R13-R15

Ferrules SAE 100 R13/R15

Jupe à sertir DIN 20023 R13/R15

Boccola Interlock R13/R15

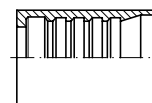

DN	DESCRIPTION DESCRIPCIÓN	Part n° Referencia	€
1"1/4	R13/R15	610102000	20,84
1"1/2	R13/R15	610102400	30,34
2"	R13/R15	610103200	49,64

## Hembras giratorias rectas BSP cono 60° con junta

BSP Swivel female 60° cone + o'ring

Femelle tournante gaz cyl BSP 60° + o'ring

Femmina diritta BSP sede 60° con o'ring

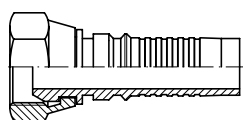

DN	THREAD ROSCA	Part n° Referencia	€
3/4"	3/4" BSP	641001212	5,49
1"	1" BSP	641001616	11,47
1"1/4	1"1/4 BSP	641002020	15,42
1"1/2	1"1/2 BSP	641002424	30,68
2"	2" BSP	641003232	53,67

## Macho rosca cilíndrica BSP cono 60°

BSP Male 60° cone

Mâle fixe gaz cyl BSP 60°

Maschio cilindrico BSP sede 60°

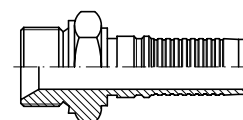

DN	THREAD ROSCA	Part n° Referencia	€
3/4"	3/4" BSP	641121212	6,84
1"	1" BSP	641121616	12,05
1"1/4	1"1/4 BSP	641122020	17,44
1"1/2	1"1/2 BSP	641122424	32,30
2"	2" BSP	641123232	54,93

## Hembras giratorias 90° BSP cono 60° con junta

BSP Swivel female 60° cone + o'ring (90° Elbow)

Femelle tournante coude 90° gaz cyl BSP 60° + o'ring

Femmina a 90° BSP sede 60° con o'ring

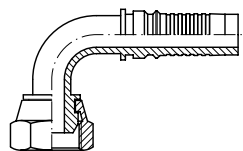

DN	THREAD ROSCA	Part n° Referencia	€
3/4"	3/4" BSP	641071212	9,93
1"	1" BSP	641071616	19,27
1"1/4	1"1/4 BSP	641072020	28,52
1"1/2	1"1/2 BSP	641072424	47,70
2"	2" BSP	641073232	82,49

## Macho rosca NPT

NPT Male

Mâle fixe NPT

Maschio conico NPT

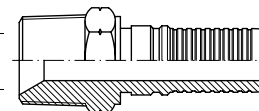

DN	THREAD ROSCA	Part n° Referencia	€
3/4"	3/4" NPT	641611212	6,40
1"	1" NPT	641611616	11,48
1"1/4	1"1/4 NPT	641612020	21,39
1"1/2	1"1/2 NPT	641612424	33,79
2"	2" NPT	641613232	49,85

## Hembras giratorias 45° BSP cono 60° con junta

BSP Swivel female 60° cone + o'ring (45° Elbow)

Femelle tournante coude 45° gaz cyl BSP 60° + o'ring

Femmina a 45° BSP sede 60° con o'ring

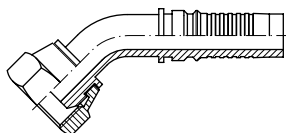

DN	THREAD ROSCA	Part n° Referencia	€
3/4"	3/4" BSP	641081212	11,93
1"	1" BSP	641081616	21,21
1"1/4	1"1/4 BSP	641082020	33,59
1"1/2	1"1/2 BSP	641082424	47,70
2"	2" BSP	641083232	82,49

# Conexiones Interlock

Interlock series fittings  
Embouts à sertir Interlock  
Raccordi serie Interlock

## Hembras giratorias rectas JIC 37°

JIC 37° Swivel female

Femelle tournante JIC 37°

Femmina diritta JIC 37°

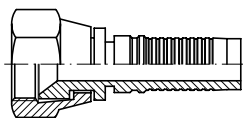

DN	THREAD ROSCA	Part nº Referencia	€
3/4"	1"1/16 12h UNF	641421712	4,24
1"	1"5/16 12h UNF	641422116	8,58
1"1/4	1"5/8 12h UNF	641422620	14,16
1"1/2	1"7/8 12h UNF	641423024	30,68
2"	2"1/2 12h UNF	641424032	51,18

## Hembras giratorias 45° JIC 37°

JIC 37° Swivel female (45° Elbow)

Femelle tournante coude 45° JIC 37°

Femmina a 45° JIC 37°

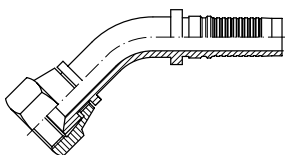

DN	THREAD ROSCA	Part nº Referencia	€
3/4"	1"1/16 12h UNF	641391712	11,94
1"	1"5/16 12h UNF	641392116	19,45
1"1/4	1"5/8 12h UNF	641392620	33,79
1"1/2	1"7/8 12h UNF	641393024	50,65
2"	2"1/2 12h UNF	641394032	82,00

## Hembras giratorias 90° JIC 37°

JIC 37° Swivel female (90° Elbow)

Femelle tournante coude 90° JIC 37°

Femmina a 90° JIC 37°

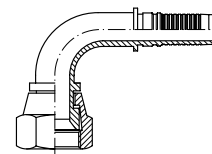

DN	THREAD ROSCA	Part nº Referencia	€
3/4"	1"1/16 12h UNF	641381712	12,56
1"	1"5/16 12h UNF	641382116	20,42
1"1/4	1"5/8 12h UNF	641382620	33,79
1"1/2	1"7/8 12h UNF	641383024	50,65
2"	2"1/2 12h UNF	641384032	82,00

## Macho JIC 37°

JIC 37° male

Mâle fixe JIC 37°

Maschio JIC 37°

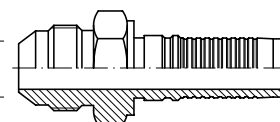

DN	THREAD ROSCA	Part nº Referencia	€
3/4"	1"1/16 12h UNF	641401712	6,40
1"	1"5/16 12h UNF	641402116	10,13
1"1/4	1"5/8 12h UNF	641402620	19,88
1"1/2	1"7/8 12h UNF	641403024	32,20
2"	2"1/2 12h UNF	641404032	53,66

## Hembra giratoria recta Métrica cono 24° con junta tórica

Metric swivel female 24° seat with o'ring

Femelle tournante Métrique 24° + o'ring

Femmina Metrica sede 24° con o'ring

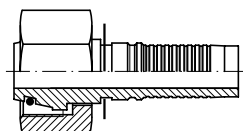

DN	PIPE TUBO	SERIE	THREAD ROSCA	Part nº Referencia	€
3/4"	20	S	M30X2	64204302012	8,19
3/4"	25	S	M36X2	64204362512	8,58
1"	30	S	M42X2	64204423016	13,59
1"1/4	38	S	M52X2	64204523820	22,16

## Hembra giratoria 45° Métrica cono 24° con junta tórica

Metric swivel female 24° seat with o'ring (45° Elbow)

Femelle tournante coude 45° Métrique + o'ring

Femmina a 45° sede 24° con o'ring

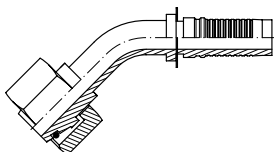

DN	PIPE TUBO	SERIE	THREAD ROSCA	Part nº Referencia	€
3/4"	20	S	M30X2	64206302012	13,20
3/4"	25	S	M36X2	64206362512	18,34
1"	30	S	M42X2	64206423016	26,80
1"1/4	38	S	M52X2	64206523820	46,29

## Hembra giratoria 90° Métrica cono 24° con junta tórica

Metric swivel female 24° seat with o'ring (90° Elbow)

Femelle tournante coude 90° Métrique + o'ring

Femmina a 90° Metrica sede 24° con o'ring

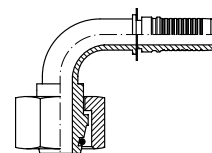

DN	PIPE TUBO	SERIE	THREAD ROSCA	Part nº Referencia	€
3/4"	20	S	M30X2	64205302012	13,62
3/4"	25	S	M36X2	64205362512	17,32
1"	30	S	M42X2	64205423016	26,64
1"1/4	38	S	M52X2	64205523820	46,13

## Macho rosca Métrica cono 24°

Metric male stud 24° cone

Mâle fixe Métrique 24° série lourde

Maschio Metrico sede 24°

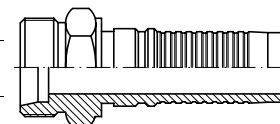

DN	PIPE TUBO	SERIE	THREAD ROSCA	Part nº Referencia	€
3/4"	20	S	M30X2	64203302012	7,66
3/4"	25	S	M36X2	64203362512	11,13
1"	30	S	M42X2	64203423016	14,80
1"1/4	38	S	M52X2	64203523820	24,15

# Conexiones Interlock

Interlock series fittings  
Embouts à sertir Interlock  
Raccordi serie Interlock

## Hembras rectas ORFS

ORFS Swivel female

Femelle droite ORFS

Femmina diritta ORFS Interlock

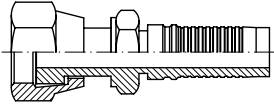

PIPE TUBO	THREAD ROSCA	Part n° Referencia	€
3/4"	1"3/16 12h UNF	649001212	8,71
1"	1"7/16 12h UNF	649001616	12,16
1"1/4	1"11/16 12h UNF	649002020	21,39
1"1/2	2" 12h UNF	649002424	29,96

## Codos 45° ORFS

ORFS Swivel female (45° Elbow)

Coude 45° femelle ORFS

Curva a 45° ORFS Interlock

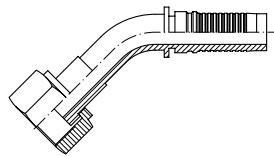

PIPE TUBO	THREAD ROSCA	Part n° Referencia	€
3/4"	1"3/16 12h UNF	649081212	12,96
1"	1"7/16 12h UNF	649081616	22,16
1"1/4	1"11/16 12h UNF	649082020	34,07
1"1/2	2" 12h UNF	649082424	42,81

## Racores para martillo

Fittings for hammer

Embouts pour marteau

Raccordi per martello

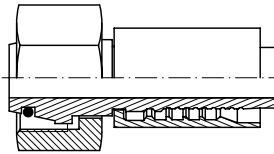

DN	PIPE TUBO	SERIE	THREAD ROSCA	Part n° Referencia	€
3/4"	25	S	M36X2	NAM362512	49,66
1"	30	S	M42X2	NAM423016	59,54
1"1/4	38	S	M52X2	NAM523820	92,53

Se venden con casquillo incluido. / With ferrule included / Avec jupe incluse / Con boccola inclusa

## Codos 90° ORFS

ORFS Swivel female (90° Elbow)

Coude 90° femelle ORFS

Curva a 90° ORFS Interlock

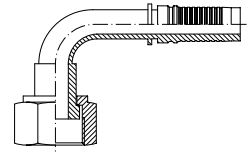

PIPE TUBO	THREAD ROSCA	Part n° Referencia	€
3/4"	1"3/16 12h UNF	649071212	13,62
1"	1"7/16 12h UNF	649071616	22,16
1"1/4	1"11/16 12h UNF	649072020	34,07
1"1/2	2" 12h UNF	649072424	42,81



# Conexiones Interlock

Interlock series fittings  
Embouts à sertir Interlock  
Raccordi serie Interlock

Hoses

Flexible hose fittings

Flow measuring

Processing machine  
for flexible hoses

## Brida SAE 3000 PSI

3000 PSI SAE Straight Flange / Code 61

Bride SAE droite série 3000 PSI

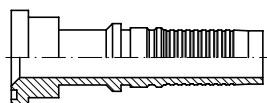

Flangia SAE 3000 PSI

DN	Ø	Part n° Referencia	€
3/4"	38.1	641821212	10,14
3/4"	44.5	641821612	14,57
1"	44.5	641821616	13,59
1"	50.8	641822016	18,85
1"1/4	50.8	641822020	20,72
1"1/4	60.3	641822420	37,42
1"1/2	60.3	641822424	40,42
1"1/2	71.4	641823224	61,41
2"	71.4	641823232	63,84

## Brida SAE 6000 PSI

6000 PSI SAE Straight Flange / Code 62

Bride SAE droite série 6000 PSI

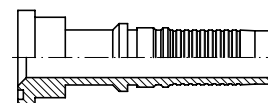

Flangia SAE 6000 PSI

DN	Ø	Part n° Referencia	€
3/4"	41,3	642821212	9,64
3/4"	47,63	642821612	13,51
1"	47,63	642821616	14,55
1"	53,98	642822016	21,21
1"1/4	53,98	642822020	22,45
1"1/4	63,5	642822420	41,79
1"1/2	63,5	642822424	42,27
1"1/2	79,4	642823224	94,26
2"	79,4	642823232	104,26

## Brida a 90° SAE 3000 PSI

3000 PSI SAE Flange (90° Elbow) / Code 61

Bride SAE coude 90° série 3000 PSI

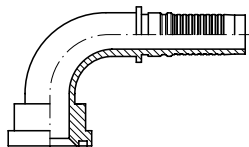

Flangia a 90° SAE 3000 PSI

DN	Ø	Part n° Referencia	€
3/4"	38.1	641831212	14,45
3/4"	44.5	641831612	19,71
1"	44.5	641831616	18,60
1"	50.8	641832016	32,56
1"1/4	50.8	641832020	25,73
1"1/4	60.3	641832420	52,85
1"1/2	60.3	641832424	55,70
1"1/2	71.4	641833224	82,84
2"	71.4	641833232	88,55

## Brida a 90° SAE 6000 PSI

6000 PSI SAE Flange (90° Elbow) / Code 62

Bride SAE coude 90° série 6000 PSI

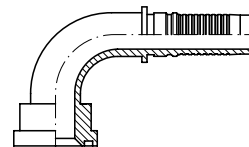

Flangia a 90° SAE 6000 PSI

DN	Ø	Part n° Referencia	€
3/4"	41.3	642831212	14,54
3/4"	47.6	642831612	25,00
1"	47.6	642831616	19,95
1"	54	642832016	37,14
1"1/4	54	642832020	29,58
1"1/4	63.5	642832420	55,70
1"1/2	63.5	642832424	58,56
1"1/2	79.4	642833224	121,40
2"	79.4	642833232	139,96

## Brida a 45° SAE 3000 PSI

3000 PSI SAE Flange (45° Elbow) / Code 61

Bride SAE coude 45° série 3000 PSI

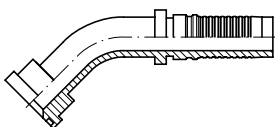

Flangia a 45° SAE 3000 PSI

DN	Ø	Part n° Referencia	€
3/4"	38.1	641841212	15,04
3/4"	44.5	641841612	21,37
1"	44.5	641841616	23,08
1"1/4	50.8	641842020	32,99
1"1/4	60.3	641842420	48,70
1"1/2	60.3	641842424	51,85
1"1/2	71.4	641843224	97,41
2"	71.4	641843232	109,97

## Brida a 45° SAE 6000 PSI

6000 PSI SAE Flange (45° Elbow) / Code 62

Bride SAE coude 45° série 6000 PSI

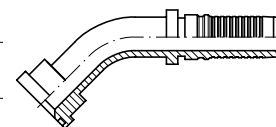

Flangia a 45° SAE 6000 PSI

DN	Ø	Part n° Referencia	€
3/4"	41,3	642841212	15,29
3/4"	47,6	642841612	24,98
1"	47,6	642841616	24,98
1"	54	642842016	37,13
1"1/4	54	642842020	35,88
1"1/4	63,5	642842420	54,50
1"1/2	63,5	642842424	60,41
1"1/2	79,4	642843224	121,40
2"	79,4	642843232	139,96

# Conexiones Interlock

*Interlock series fittings*

*Embouts à sertir Interlock*

*Raccordi serie Interlock*

## Brida 9000 PSI (14,3)

*9000 PSI Straight flange (14,3)*

*Bride droite série 9000 PSI (14,3)*

*Flangia 9000 PSI (14,3)*

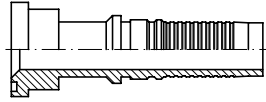

DN	Ø	Part n° Referencia	€
3/4"	41,3	643821212	13,82
1"	47,6	643821616	20,74
1"	54	643822016	28,28
1"1/4	54	643822020	30,16
1"1/4	63,5	643822420	43,99
1"1/2	63,5	643822424	49,01

## Brida a 45° 9000 PSI (14,3)

*45° 9000 PSI Flange (14,3)*

*Bride coude 45° série 9000 PSI (14,3)*

*Flangia a 45° 9000 PSI (14,3)*

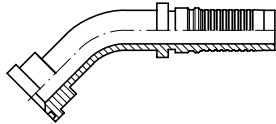

DN	Ø	Part n° Referencia	€
3/4"	41,3	643841212	17,29
3/4"	47,6	643841612	26,71
1"	47,6	643841616	27,65
1"	54	643842016	38,17
1"1/4	54	643842020	39,27
1"1/4	63,5	643842420	59,70
1"1/2	63,5	643842424	64,41

## Brida a 90° 9000 PSI (14,3)

*90° 9000 PSI Flange (14,3)*

*Bride coude 90° série 9000 PSI (14,3)*

*Flangia a 90° 9000 PSI (14,3)*

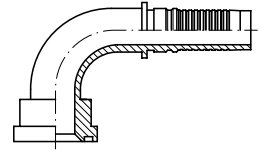

DN	Ø	Part n° Referencia	€
3/4"	41,3	643831212	19,48
3/4"	47,6	643831612	29,85
1"	47,6	643831616	31,42
1"	54	643832016	53,41
1"1/4	54	643832020	55,77
1"1/4	63,5	643832420	71,49
1"1/2	63,5	643832424	73,84

# Conexiones Interlock

Interlock series fittings  
Embouts à sertir Interlock  
Raccordi serie Interlock

## Espiga para brida macho Poclair

Poclair male flange

Embout bride mâle Poclair



Inserto per flangia maschio Poclair 4SH

DN	Ø	Part nº Referencia	€
3/4"	3/4"	648011212	*
1"	1"	648011616	*
1"1/4	1"1/4	648012020	*

## Espiga para brida hembra Poclair

Poclair female flange

Embout bride femelle Poclair

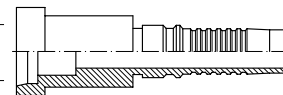

Inserto per flangia femmina Poclair 4SH

DN	Ø	Part nº Referencia	€
3/4"	3/4"	648021212	*
1"	1"	648021616	*
1"1/4	1"1/4	648022020	*

## Brida entera macho Poclair 4 agujeros

Male Poclair flange 4 holes

Bride rectangulaire de fixation mâle Poclair-4 trous

Flangia intera maschio Poclair 4 fori

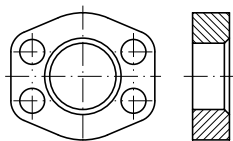

SIZE TAMAÑO	Part nº Referencia	€
1/2"	448050808 *	15,23
3/4"	448051212	26,99
1"	448051616	32,18
1"1/4	448052020	42,75

\*Hasta fin de existencias. / \*Until end of stock. / \*Jusqu'à la fin du stock. / \*Fino ad esaurimento scorta.

## Brida entera hembra Poclair 4 agujeros

Female Poclair flange 4 holes

Bride rectangulaire de fixation femelle Poclair-4 trous

Flangia intera femmina Poclair 4 fori

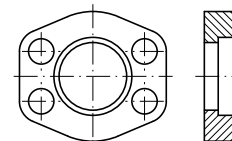

SIZE TAMAÑO	Part nº Referencia	€
1/2"	448060808 *	15,23
3/4"	448061212	42,42
1"	448061616	48,25
1"1/4	448062020	60,21

\*Hasta fin de existencias. / \*Until end of stock. / \*Jusqu'à la fin du stock. / \*Fino ad esaurimento scorta.

## Brida entera macho Poclair 2 agujeros

Male Poclair flange 2 holes

Bride ovale fixation mâle Poclair 2 trous

Flangia intera maschio Poclair 2 fori

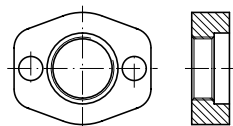

PIPE TUBO	Part nº Referencia	€
5/8"	448071010	22,45
3/4"	448071212	24,45
1"	448071616	29,51
1"1/4	448072020	47,01

## Brida entera hembra Poclair 2 agujeros

Female Poclair flange 2 holes

Bride ovale fixation femelle Poclair 2 trous

Flangia intera femmina Poclair 2 fori

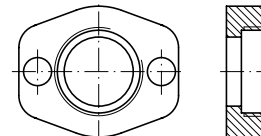

PIPE TUBO	Part nº Referencia	€
5/8"	448081010	18,21
1"	448081616	23,03
1"1/4	448082020	25,05

Hasta fin de existencias. / Until end of stock. / Jusqu'à la fin du stock. / Fino ad esaurimento scorta.

# Racores una sola pieza

*One Piece Series*  
Série Pré-sertis  
Serie Compatta

## ■ Conexiones compactas 1SC / 1SN / 2SC / R6\*

*One piece fittings 1SC / 1SN / 2SC / R6*  
Embouts pré-sertis 1SC / 1SN / 2SC / R6  
Raccordi compatti 1SC / 1SN / 2SC / R6

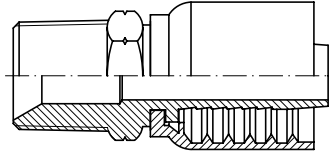

EN 857 1SC	EN 853 1SN SAE 100 R1AT	EN 857 2SC	SAE 100 R6
---------------	----------------------------------	---------------	---------------

## ■ Conexiones compactas Serie 43 R1AT / R2AT / 1SN / 2SN / R16 / 2SC

*One piece fittings 43 Series R1AT / R2AT / 1SN / 2SN / R16 / 2SC*  
Embouts pré-sertis R1AT / R2AT / 1SN / 2SN / R16 / 2SC Série 43  
Raccordi compatti R1AT / R2AT / 1SN / 2SN / R16 / 2SC Serie 43

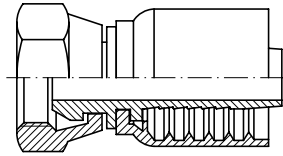

EN 853 1SN SAE 100 R1AT	EN 853 2SN SAE 100 R2AT	EN 857 2SC	SAE 100 R16	SUPERSERVICE 155° 2SC
----------------------------------	----------------------------------	---------------	----------------	-----------------------------

## ■ Conexiones compactas R7 / R8 y elastómero malla metálica\*

*Piece fittings R7 / R8 & braid of steel wire*  
Embouts pré-sertis R7 / R8 et tresse métallique  
Raccordi compatti serie R7 / R8 e elastomero treccia metallica

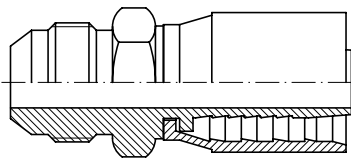

EN 855 SAE 100 R7	EN 855 SAE 100 R8	Metallic braid elastomer
-------------------------	-------------------------	--------------------------------

## ■ Conexiones compactas PTFE liso\*

*One piece fittings for smooth PTFE*  
Embouts pré-sertis pour PTFE lisse  
Raccordi compatti serie PTFE liscio

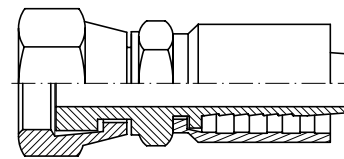

Smooth PTFE 1 braid
---------------------------

## ■ Conexiones compactas PTFE corrugado\*

*One piece fittings for convoluted PTFE*  
Embouts pré-sertis pour PTFE convolute  
Raccordi compatti serie PTFE convoluto

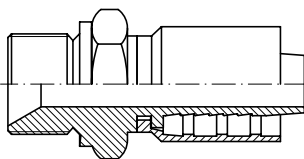

Convoluted PTFE
--------------------

## ■ Conexiones compactas Serie BW R12 / 4SP / 4SH

*One piece fittings BW Series R12 / 4SP / 4SH*  
Embouts pré-sertis R12 / 4SP / 4SH Série BW  
Raccordi compatti R12 / 4SP / 4SH Serie BW

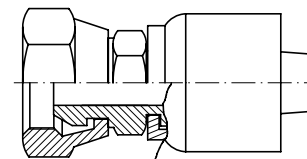

EN 856 SAE 100 R12	EN 856 4SP SAE 100 R9R	EN 856 4SH
--------------------------	---------------------------------	---------------

# Casquillos Una sola pieza

Ferrules for One Piece Fittings  
Jupes pour Embouts une seule pièce  
Boccole per Raccordi un pezzo

Hoses

Flexible hose fittings

Flow measuring

Processing machine  
for flexible hoses

## Casquillos 1SC/1SN/2SC/R6/2TE

Ferrules 1SC/1SN/2SC/R6/2TE

Jupes à sertir 1SC/1SN/2SC/R6/2TE

Boccole a pressione per 1SC/1SN/2SC/R6/2TE

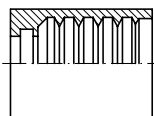

DN	Part n° Referencia	€
1/4"	SC21120400	*
5/16"	SC21120500	*
3/8"	SC21120600	*
1/2"	SC21120800	*
5/8"	SC21121000	*
3/4"	SC21121200	*
1"	SC21121600	*

\*Ver precios en p.34 / \*See prices p.34 / \*Voir les prix p.34 / \*Vedere prezzi p.34

## Casquillos R6, R7, R8 y malla metálica

Ferrules SAE 100 R6, R7, R8 and metallic braid

Jupes à sertir R6, R7, R8 et tresse métallique

Boccole a pressione per SAE R6, R7, R8 e Treccia Metallica

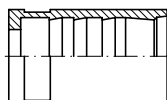

DN	Part n° Referencia	€
1/8"	DI2300200	*
3/16"	DI2300300	*
1/4"	DI2300400	*
5/16"	DI2300500	*
3/8"	DI2300600	*
1/2"	DI2300800	*
5/8"	DI2301000	*
3/4"	DI2301200	*
1"	DI2301600	*

\*Ver precios en p.34 / \*See prices p.34 / \*Voir les prix p.34 / \*Vedere prezzi p.34

## Casquillos PTFE Corrugado alta presión

Ferrules for Corrugated PTFE

Jupes à sertir PTFE Convoluté haute pression

Boccole a pressione per tubo al PTFE Corrugato alta pressione

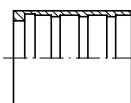

DN	Part n° Referencia	€
1/4"	210410400	*
3/8"	210410600	*
1/2"	210410800	*
5/8"	210411000	*
3/4"	210411201	*
1"	210411600	*
1"1/4	210412001	*
1" 1/2	210412400	*
2"	210413200	*

\*Ver precios en p.35 / \*See prices p.35 / \*Voir prix p.35 / \*Vedere prezzi p.35

## Casquillos 1SN/2SN /R16/2SC para conexiones de una sola pieza serie 43

Ferrules 1SN/2SN/R16/2SC for one piece fittings 43 series

Jupes 1SN/2SN/R16/2SC pour embous pré-sertis série 43

Boccole a pressione 1SN/2SN/R16/2SN per raccordi compatti serie 43

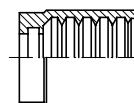

DN	Part n° Referencia	€
1/4"	PFC221200400	1,16
5/16"	PFC221200500	1,30
3/8"	PFC221200600	1,48
1/2"	PFC221200800	1,89
5/8"	PFC221201000	1,95
3/4"	PFC221201200	3,26
1"	PFC221201600	4,69
1"1/4	PFC221202000	12,10
1"1/2	PFC221202400	17,02
2"	PFC221203200	21,59

## Casquillos PTFE Liso alta presión

Ferrules for Smooth PTFE

Jupes à sertir pour PTFE Lisse haute pression

Boccole a pressione per tubo al PTFE Liscio alta pressione

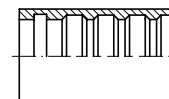

DN	Part n° Referencia	€
3/16"	210400300	*
1/4"	210400400	*
5/16"	210400500	*
3/8"	210400600	*
1/2"	210400800	*
5/8"	210401000	*
3/4"	210401200	*
1"	210401600	*

\*Ver precios en p.35 / \*See prices p.35 / \*Voir prix p.35 / \*Vedere prezzi p.35

## Casquillos compactos serie BW

Ferrules for fittings BW series

Jupes pour embouts série BW

Boccole a pressione per raccordi serie BW

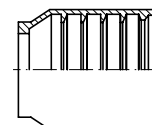

DN	Part n° Referencia	€
3/4"	AC680101200	7,91
1"	AC680101600	11,60
1" 1/4	AC680102000	18,68

# Conexiones Una sola pieza Serie 43

One piece fittings series 43

Embouts une seule pièce Série 43

Raccordi un pezzo Serie 43

## Machos una sola pieza rosca JIC 37°

One piece JIC 37° male

Mâle pré-serti JIC 37°

Maschio compatto JIC sede 37°

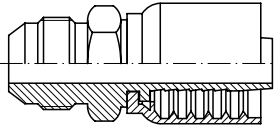

DN	THREAD ROSCA	Part n° Referencia	€
1/4"	7/16" 20h UNF	281400704	3,07
3/8"	9/16" 18h UNF	281400906	3,64
1/2"	3/4" 16h UNF	281401208	4,92
3/4"	1"1/16 12h UN	281401712	9,52
1"	1"5/16 12h UN	281402116	16,34
1"1/4"	1"5/8 12h UN	281402620	29,69
1"1/2"	1"7/8 12h UN	281403024	41,61
2"	2"1/2 12h UN	281404032	66,65

## Hembras giratorias rectas una sola pieza JIC 37°

One piece JIC 37° female

Femelle pré-sertie JIC 37°

Femmina diritta compatta JIC 37°

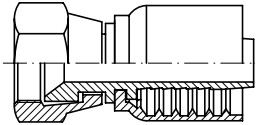

DN	THREAD ROSCA	Part n° Referencia	€
1/4"	7/16" 20h UNF	281420704	3,13
3/8"	9/16" 18h UNF	281420906	3,65
1/2"	3/4" 16h UNF	281421208	4,92
5/8"	7/8" 14h UNF	281421410	4,85
3/4"	1"1/16 12h UN	281421712	8,34
1"	1"5/16 12h UN	281422116	14,57
1"1/4"	1"5/8 12h UN	281422620	25,99
1"1/2"	1"7/8 12h UN	281423024	36,12
2"	2"1/2 12h UN	281424032	56,54

## Hembras giratorias 90° una sola pieza JIC 37°

One piece JIC 37° Female (90° Elbow)

Coude 90° femelle pré-sertie JIC 37°

Femmina 90° compatta JIC 37°

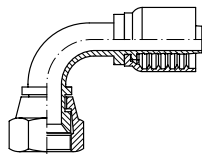

DN	THREAD ROSCA	Part n° Referencia	€
1/4"	7/16" 20h UNF	281380704	3,97
3/8"	9/16" 18h UNF	281380906	4,84
1/2"	3/4" 16h UNF	281381208	6,48
1/2"	7/8" 14h UNF	281381408	6,91
5/8"	7/8" 14h UNF	281381410	8,79
3/4"	1"1/16 12h UN	281381712	12,04
1"	1"5/16 12h UN	281382116	19,28
1"1/4"	1"5/8 12h UN	281382620	37,22
1"1/2"	1"7/8 12h UN	281383024	53,12
2"	2"1/2 12h UN	281384032	97,70

## Hembras giratorias 45° una sola pieza JIC 37°

One piece JIC 37° Female (45° Elbow)

Coude 45° femelle pré-sertie JIC 37°

Femmina 45° compatta JIC 37°

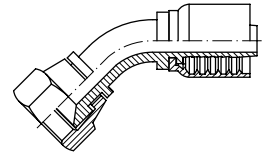

DN	THREAD ROSCA	Part n° Referencia	€
1/4"	7/16" 20h UNF	281390704	4,38
3/8"	9/16" 18h UNF	281390906	5,40
1/2"	3/4" 16h UNF	281391208	7,29
3/4"	1"1/16 12h UN	281391712	12,30
1"	1"5/16 12h UN	281392116	20,12
1"1/4"	1"5/8 12h UN	281392620	41,30
1"1/2"	1"7/8 12h UN	281393024	60,53
2"	2"1/2 12h UN	281394032	97,70

## Hembras giratorias rectas una sola pieza JIC 37° doble hexagonal

One piece double hexagonal JIC 37° female

Femelle pré-sertie JIC 37° double hexagonal

Femmina diritta JIC 37° doppio esagono

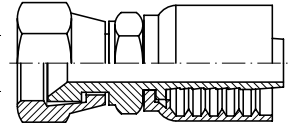

DN	THREAD ROSCA	Part n° Referencia	€
1/4"	7/16" 20h UNF	282420704	3,97
3/8"	9/16" 18h UNF	282420906	5,00
1/2"	3/4" 16h UNF	282421208	6,39
1/2"	7/8" 14h UNF	282421408	6,94
3/4"	1"1/16 12h UN	282421712	10,89
1"	1"5/16 12h UN	282422116	16,20
1"1/4"	1"5/8 12h UN	282422620	32,62
1"1/2"	1"7/8 12h UN	282423024	48,28
2"	2"1/2 12h UN	282424032	73,33

# Conexiones Una sola pieza Serie 43

One piece fittings series 43

Embouts une seule pièce Série 43

Raccordi un pezzo Serie 43

## Hembras giratorias rectas una sola pieza ORFS

One piece ORFS female

Femelle pré-sertie ORFS

Femmina diritta compatta ORFS

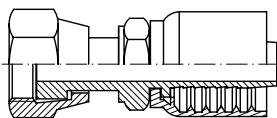

DN	THREAD ROSCA	Part n° Referencia	€
1/4"	9/16" 18h	289000904	4,07
3/8"	11/16" 16h	289001106	4,70
1/2"	13/16" 16h	289001308	5,68
5/8"	1" 14h	289001610	7,25
3/4"	1"3/16 12h	289001912	11,38
1"	1"7/16 12h	289002316	9,79
1"1/4	1"11/16 12h	289002720	31,08
1"1/2	2" 12h	289003224	46,65

## Hembras giratorias 90° una sola pieza ORFS

One piece ORFS female (90° Elbow)

Coude 90° femelle pré-sertie ORFS

Femmina 90° compatta ORFS

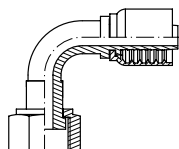

DN	THREAD ROSCA	Part n° Referencia	€
1/4"	9/16" 18h	289070904	4,93
3/8"	11/16" 16h	289071106	5,76
1/2"	13/16" 16h	289071308	7,73
5/8"	1" 14h	289071610	10,50
3/4"	1"3/16 12h	289071912	14,82
1"	1"7/16 12h	289072316	38,88
1"1/4	1"11/16 12h	289072720	44,75
1"1/2	2" 12h	289073224	62,50

## Hembras giratorias 45° una sola pieza ORFS

One piece ORFS female (45° Elbow)

Coude 45° femelle pré-sertie ORFS

Femmina 45° compatta ORFS

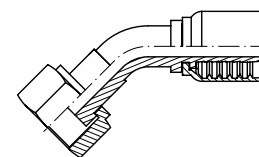

DN	THREAD ROSCA	Part n° Referencia	€
1/4"	9/16" 18h	289080904	5,20
3/8"	11/16" 16h	289081106	6,03
1/2"	13/16" 16h	289081308	7,81
5/8"	1" 14h	289081610	10,50
3/4"	1"3/16 12h	289081912	16,95
1"	1"7/16 12h	289082316	27,26
1"1/4	1"11/16 12h	289082720	42,34
1"1/2	2" 12h	289083224	62,50

## Machos una sola pieza ORFS

One piece ORFS male

Mâle pré-serti ORFS

Maschio compatto ORFS

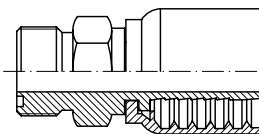

DN	THREAD ROSCA	Part n° Referencia	€
1/4"	9/16" 18h	289120904	3,87
3/8"	11/16" 16h	289121106	4,87
1/2"	13/16" 16h	289121308	6,31
5/8"	1" 14h	289121610	7,06
3/4"	1"3/16 12h	289121912	12,14
1"	1"7/16 12h	289122316	20,68
1"1/4	1"11/16 12h	289122720	33,27

# Conexiones Una sola pieza Serie 43

One piece fittings series 43

Embouts une seule pièce Série 43

Raccordi un pezzo Serie 43

## Hembras giratorias rectas una sola pieza rosca NPSM cono 60°

One piece NPSM female 60° cone

Femelle pré-sertie NPSM cone 60°

Femmina diritta compatta NPSM sede 60°

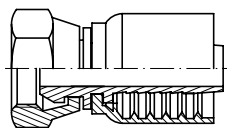

DN	THREAD ROSCA	Part n° Referencia	€
1/4"	1/4" 18h NPSM	282610404	3,80
3/8"	3/8" 18h NPSM	282610606	4,45
1/2"	1/2" 14h NPSM	282610808	5,68
3/4"	3/4" 14h NPSM	282611212	9,26
1"	1" - 11 1/2 h NPSM	282611616	14,32

## Machos una sola pieza rosca cónica NPT

One piece NPT male

Mâle pré-serti NPT

Maschio compatto conico NPT

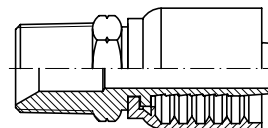

DN	THREAD ROSCA	Part n° Referencia	€
1/4"	1/4" NPT	281610404	3,49
1/4"	3/8" NPT	281610604	4,29
3/8"	3/8" NPT	281610606	4,15
1/2"	1/2" NPT	281610808	5,08
3/4"	3/4" NPT	281611212	8,09
1"	1" NPT	281611616	14,01
1"1/4"	1"1/4 NPT	281612020	26,18
1"1/2"	1"1/2 NPT	281612424	37,02
2"	2" NPT	281613232	59,19

## Bridas rectas una sola pieza SAE 3000 PSI

One piece 3000 PSI SAE Straight Flange / Code 61

Bride SAE droite pré-sertie série 3000 PSI

Flangia diritta compatta SAE 3000 PSI

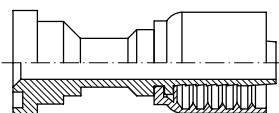

DN	Ø	Part n° Referencia	€
1/2"	30.2	281820808	8,04
3/4"	38.1	281821212	13,04
1"	44.5	281821616	18,14
1"1/4"	50.8	281822020	29,38
1"1/2"	60.3	281822424	42,40
2"	71.4	281823232	63,78

## Bridas rectas una sola pieza SAE 6000 PSI

One piece 6000 PSI SAE Straight Flange / Code 62

Bride SAE droite pré-sertie série 6000 PSI

Flangia diritta compatta SAE 6000 PSI

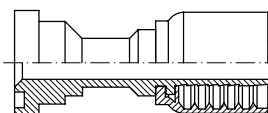

DN	Ø	Part n° Referencia	€
1/2"	31.8	282820808	8,99
3/4"	41.3	282821212	15,19
1"	47.6	282821616	21,91
1"1/4"	54	282822020	33,74
1"1/2"	63.5	282822424	49,62
2"	79.4	282823232	82,62

## Bridas 90° una sola pieza SAE 3000 PSI

One piece 3000 PSI SAE 90° Flange / Code 61

Bride SAE coude 90° pré-sertie série 3000 PSI

Flangia 90° compatta SAE 3000 PSI

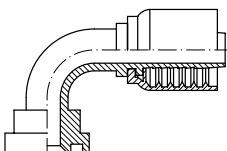

DN	Ø	Part n° Referencia	€
1/2"	30.2	281830808	10,04
3/4"	38.1	281831212	15,10
1"	44.5	281831616	23,32
1"1/4"	50.8	281832020	35,89
1"1/2"	60.3	281832424	55,64
2"	71.4	281833232	96,72

## Bridas 90° una sola pieza SAE 6000 PSI

One piece 6000 PSI SAE 90° Flange / Code 62

Bride SAE coude 90° pré-sertie série 6000 PSI

Flangia 90° compatta SAE 6000 PSI

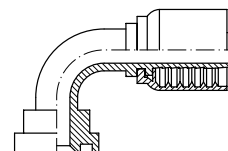

DN	Ø	Part n° Referencia	€
1/2"	31.8	282830808	10,68
3/4"	41.3	282831212	15,66
1"	47.6	282831616	25,48
1"1/4"	54	282832020	38,92
1"1/2"	63.5	282832424	57,42

## Bridas 45° una sola pieza SAE 3000 PSI

One piece 3000 PSI SAE 45° Flange / Code 61

Bride SAE coude 45° pré-sertie série 3000 PSI

Flangia 45° compatta SAE 3000 PSI

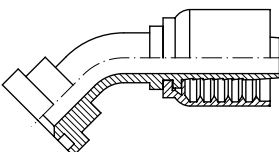

DN	Ø	Part n° Referencia	€
1/2"	30.2	281840808	10,04
3/4"	38.1	281841212	15,10
1"	44.5	281841616	23,32
1"1/4"	50.8	281842020	35,89
1"1/2"	60.3	281842424	55,64
2"	71.4	281843232	96,72

## Bridas 45° una sola pieza SAE 6000 PSI

One piece 6000 PSI SAE 45° Flange / Code 62

Bride SAE coude 45° pré-sertie série 6000 PSI

Flangia 45° compatta SAE 6000 PSI

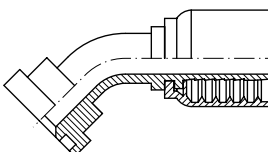

DN	Ø	Part n° Referencia	€
1/2"	31.8	282840808	10,68
3/4"	41.3	282841212	15,66
1"	47.6	282841616	25,48
1"1/4"	54	282842020	38,92
1"1/2"	63.5	282842424	57,42
2"	79.4	282843232	100,97



# Conexiones Una sola pieza Serie 43

One piece fittings series 43

Embouts une seule pièce Série 43

Raccordi un pezzo Serie 43

Hoses

Flexible hose fittings

Flow measuring

Processing machine for flexible hoses

## Hembras giratorias rectas una sola pieza rosca Métrica cono 24° - DKO

One piece Metric female cone 24°

Femelle pré-sertie Métrique cone 24°

Femmina diritta compatta Metrica sede 24°

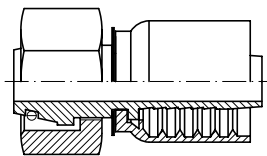

DN	PIPE TUBO	SERIE	THREAD ROSCA	Part n° Referencia	€
1/4"	6	L	M12x1.5	28804120604	3,28
1/4"	8	L	M14x1.5	28804140804	3,11
1/4"	8	S	M16x1.5	28804160804	3,45
5/16"	10	L	M16x1.5	28804161005	3,05
3/8"	10	L	M16x1.5	28804161006	4,33
1/4"	10	S	M18x1.5	28804181004	3,61
3/8"	12	L	M18x1.5	28804181206	3,84
3/8"	12	S	M20x1.5	28804201206	4,14
1/2"	15	L	M22x1.5	28804221508	4,89
1/2"	16	S	M24x1.5	28804241608	5,60
1/2"	18	L	M26x1.5	28804261808	6,78
5/8"	18	L	M26x1.5	28804261810	5,49
5/8"	20	S	M30x2	28804302010	6,26
3/4"	20	S	M30x2	28804302012	10,24
3/4"	22	L	M30x2	28804302212	8,68
3/4"	25	S	M36x2	28804362512	12,89
1"	25	S	M36x2	28804362516	16,89
1"	28	L	M36x2	28804362816	15,45
1"	30	S	M42x2	28804423016	18,70
1 1/4"	35	L	M45x2	28804453520	25,99
1 1/4"	38	S	M52x2	28804523820	29,92
1 1/2"	42	L	M52x2	28804524224	35,96

## Hembras giratorias 45° una sola pieza Métricas cono 24° - DKO 45°

One piece Metric female cone 24° (45° Elbow)

Coude 45° femelle pré-sertie Métrique cone 24°

Femmina 45° compatta Metrica sede 24°

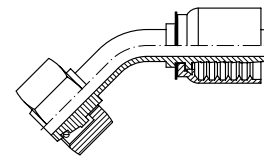

DN	PIPE TUBO	SERIE	THREAD ROSCA	Part n° Referencia	€
1/4"	6	L	M12x1.5	28306120604	4,84
1/4"	8	L	M14x1.5	28306140804	4,29
1/4"	8	S	M16x1.5	28306160804	4,98
5/16"	10	L	M16x1.5	28306161005	3,65
3/8"	10	L	M16x1.5	28306161006	5,27
1/4"	10	S	M18x1.5	28306181004	5,56
3/8"	12	L	M18x1.5	28306181206	4,98
3/8"	12	S	M20x1.5	28306201206	6,19
1/2"	15	L	M22x1.5	28306221508	7,16
1/2"	16	S	M24x1.5	28306241608	7,44
5/8"	18	L	M26x1.5	28306261810	8,74
5/8"	20	S	M30x2	28306302010	10,47
3/4"	20	S	M30x2	28306302012	14,69
3/4"	22	L	M30x2	28306302212	14,01
3/4"	25	S	M36x2	28306362512	18,59
1"	25	S	M36x2	28306362516	21,57
1"	28	L	M36x2	28306362816	21,57
1"	30	S	M42x2	28306423016	26,10
1 1/4"	35	L	M45x2	28306453520	38,38
1 1/4"	38	S	M52x2	28306523820	48,91
1 1/2"	42	L	M52x2	28306524224	58,60

## Hembras giratorias 90° una sola pieza Métricas cono 24° - DKO 90°

One piece Metric female cone 24° (90° Elbow)

Coude 90° femelle pré-sertie Métrique cone 24°

Femmina 90° compatta Metrica sede 24°

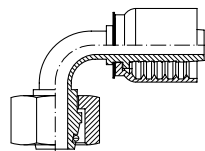

DN	PIPE TUBO	SERIE	THREAD ROSCA	Part n° Referencia	€
1/4"	6	L	M12x1.5	28305120604	4,21
1/4"	8	L	M14x1.5	28305140804	4,22
1/4"	8	S	M16x1.5	28305160804	4,61
5/16"	10	L	M16x1.5	28305161005	4,01
1/4"	10	S	M18x1.5	28305181004	4,62
3/8"	12	L	M18x1.5	28305181206	4,79
5/16"	12	S	M20x1.5	28305201205	5,38
3/8"	12	S	M20x1.5	28305201206	5,06
1/2"	15	L	M22x1.5	28305221508	6,56
1/2"	16	S	M24x1.5	28305241608	7,06
5/8"	18	L	M26x1.5	28305261810	8,37
5/8"	20	S	M30x2	28305302010	9,35
3/4"	20	S	M30x2	28305302012	14,23
3/4"	22	L	M30x2	28305302212	13,82
3/4"	25	S	M36x2	28305362512	17,04
1"	25	S	M36x2	28305362516	23,32
1"	28	L	M36x2	28305362816	21,52
1"	30	S	M42x2	28305423016	27,66
1 1/4"	35	L	M45x2	28305453520	36,45
1 1/4"	38	S	M52x2	28305523820	46,17
1 1/2"	42	L	M52x2	28305524224	59,95

## Machos una sola pieza rosca Métrica cono 24°

One piece Metric male cone 24°

Mâle pré-serti Métrique cone 24°

Maschio compatto Metrico sede 24°

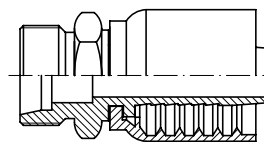

DN	PIPE TUBO	SERIE	THREAD ROSCA	Part n° Referencia	€
1/4"	6	L	M12x1.5	28203120604	3,32
1/4"	8	L	M14x1.5	28203140804	3,26
1/4"	8	S	M16x1.5	28203160804	3,64
5/16"	10	L	M16x1.5	28203161005	3,06
3/8"	10	L	M16x1.5	28203161006	3,80
1/4"	10	S	M18x1.5	28203181004	4,48
3/8"	12	L	M18x1.5	28203181206	3,63
3/8"	12	S	M20x1.5	28203201206	4,30
1/2"	15	L	M22x1.5	28203221508	4,85
1/2"	16	S	M24x1.5	28203241608	5,27
5/8"	18	L	M26x1.5	28203261810	5,15
5/8"	20	S	M30x2	28203302010	6,56
3/4"	20	S	M30x2	28203302012	9,59
3/4"	22	L	M30x2	28203302212	9,37
3/4"	25	S	M36x2	28203362512	12,98
1"	25	S	M36x2	28203362516	15,56
1"	28	L	M36x2	28203362816	15,01
1"	30	S	M42x2	28203423016	18,61
1 1/4"	35	L	M45x2	28203453520	24,52
1 1/4"	38	S	M52x2	28203523820	31,44
1 1/2"	42	L	M52x2	28203524224	36,53

# Conexiones Una sola pieza Serie 43

One piece fittings series 43

Embouts une seule pièce Série 43

Raccordi un pezzo Serie 43

## Hembras giratorias rectas una sola pieza rosca BSP cono 60°

One piece BSP female 60° cone

Femelle pré-sertie BSP cone 60°

Femmina diritta compatta BSP sede 60°

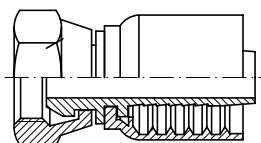

DN	THREAD ROSCA	Part n° Referencia	€
1/4"	1/4" BSP	281000404	3,09
3/8"	3/8" BSP	281000606	3,62
1/2"	1/2" BSP	281000808	4,80
5/8"	1/2" BSP	281000810	5,24
5/8"	5/8" BSP	281001010	5,50
3/4"	3/4" BSP	281001212	8,44
1"	1" BSP	281001616	12,82
1"1/4	1"1/4 BSP	281102020	27,79
1"1/2	1"1/2 BSP	281102424	37,25
2"	2" BSP	281103232	57,91

## Machos una sola pieza rosca cilíndrica BSP cono 60°

One piece BSP male 60° cone

Mâle pré-serti BSP cone 60°

Maschio compatto cilindrico BSP sede 60°

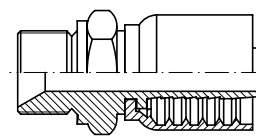

DN	THREAD ROSCA	Part n° Referencia	€
1/4"	1/4" BSP	281120404	3,29
3/8"	3/8" BSP	281120606	3,93
3/8"	1/2" BSP	281120806	4,55
1/2"	1/2" BSP	281120808	4,99
3/4"	3/4" BSP	281121212	8,56
1"	1" BSP	281121616	13,82
1"1/4	1"1/4 BSP	281122020	27,91
1"1/2	1"1/2 BSP	281122424	35,12
2"	2" BSP	281123232	65,67

## Hembras giratorias 90° una sola pieza rosca BSP cono 60°

One piece BSP female cone 60° (90° Elbow)

Coude 90° femelle pré-sertie BSP cone 60°

Femmina 90° compatta BSP sede 60°

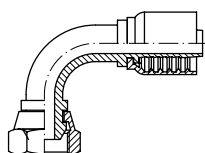

DN	THREAD ROSCA	Part n° Referencia	€
1/4"	1/4" BSP	281070404	3,86
3/8"	3/8" BSP	281070606	4,63
1/2"	1/2" BSP	281070808	5,91
3/4"	3/4" BSP	281071212	10,88
1"	1" BSP	281071616	18,29
1"1/4	1"1/4 BSP	281172020	40,90
1"1/2	1"1/2 BSP	281172424	50,33
2"	2" BSP	281173232	99,54

## Hembras giratorias rectas una sola pieza rosca BSP cono 60° doble hexagonal

One piece double hexagonal BSP female 60° cone

Femelle pré-sertie BSP cone 60° double hexagonal

Femmina diritta compatta BSP sede 60° doppio esagono

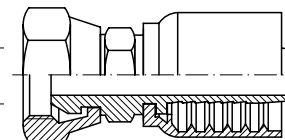

DN	THREAD ROSCA	Part n° Referencia	€
1/4"	1/4" BSP	284000404	4,26
5/16"	3/8" BSP	284000605	4,35
3/8"	3/8" BSP	284000606	5,02
1/2"	1/2" BSP	284000808	6,37
3/4"	3/4" BSP	284001212	11,76
1"	1" BSP	284001616	16,80
1"1/4	1"1/4 BSP	284002020	33,79
1"1/2	1"1/2 BSP	284002424	49,84
2"	2" BSP	284003232	75,56

## Hembras giratorias 45° una sola pieza rosca BSP cono 60°

One piece BSP female 60° cone (45° Elbow)

Coude 45° femelle pré-sertie BSP cone 60°

Femmina 45° compatta BSP sede 60°

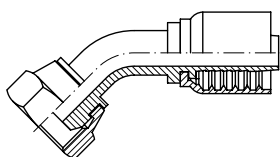

DN	THREAD ROSCA	Part n° Referencia	€
1/4"	1/4" BSP	281080404	3,96
3/8"	3/8" BSP	281080606	5,08
1/2"	1/2" BSP	281080808	6,88
3/4"	3/4" BSP	281081212	12,54
1"	1" BSP	281081616	18,95
1"1/4	1"1/4 BSP	281182020	31,37
1"1/2	1"1/2 BSP	281182424	38,29
2"	2" BSP	281183232	63,67

# Conexiones Una sola pieza Serie BW

One piece fittings BW series

Embouts une seule pièce Série BW

Raccordi BW - 1 pezzo

## Macho JIC 37°

JIC 37° male

Mâle JIC 37°

Maschio JIC 37°

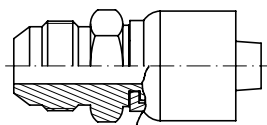

DN	THREAD ROSCA	Part n° Referencia	€
3/4"	1"1/16 12h UNF	681401712	13,61
1"	1"5/16 12h UNF	681402116	21,73

## Hembras giratorias rectas JIC 37° doble hexagono

JIC 37° swivel female

Femelle JIC 37°

Femmina diritta JIC 37°

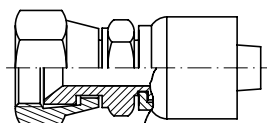

DN	THREAD ROSCA	Part n° Referencia	€
3/4"	1"1/16 12h UNF	682421712	15,38
1"	1"5/16 12h UNF	682422116	22,61

## Hembra giratoria recta ORFS asiento plano doble hexagono

ORFS Swivel female straight

Femelle droite ORFS

Femmina diritta ORFS

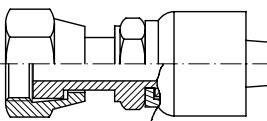

PIPE TUBO	THREAD ROSCA	Part n° Referencia	€
3/4"	1"3/16 12h UNF	689011212	16,38
1"	1"7/16 12h UNF	689011616	24,69

## Hembra giratoria 90° ORFS asiento plano

ORFS Swivel female (90° Elbow)

Coude 90° femelle ORFS

Femmina 90° ORFS

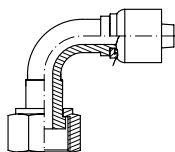

PIPE TUBO	THREAD ROSCA	Part n° Referencia	€
3/4"	1"3/16 12h UNF	689071212	20,48
1"	1"7/16 12h UNF	689071616	30,20

## Hembras giratorias 90° JIC 37°

JIC 37° swivel female (90° Elbow)

Coude 90° femelle JIC 37°

Femmina gir. 90° JIC 37°

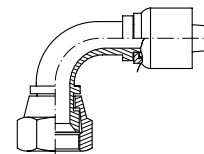

DN	THREAD ROSCA	Part n° Referencia	€
3/4"	1"1/16 12h UNF	681381712	19,95
1"	1"5/16 12h UNF	681382116	30,20

## Hembras giratorias 45° JIC 37°

JIC 37° swivel female (45° Elbow)

Coude 45° femelle JIC 37°

Femmina gir. 45° JIC 37°

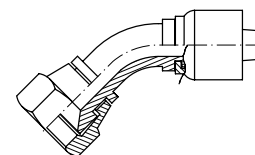

DN	THREAD ROSCA	Part n° Referencia	€
3/4"	1"1/16 12h UNF	681391712	19,95
1"	1"5/16 12h UNF	681392116	30,20

## Hembra giratoria 45° ORFS asiento plano

ORFS Swivel female (45° Elbow)

Coude 45° femelle ORFS

Femmina 45° ORFS

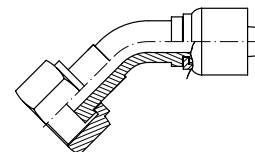

PIPE TUBO	THREAD ROSCA	Part n° Referencia	€
3/4"	1"3/16 12h UNF	689081212	20,48
1"	1"7/16 12h UNF	689081616	30,20

# Conexiones Una sola pieza Serie BW

One piece fittings BW series

Embouts une seule pièce Série BW

Raccordi BW - 1 pezzo

## Brida recta SAE 3000 PSI

One piece 3000 PSI SAE Straight Flange / Code 61

Bride SAE droite série 3000 PSI

Flangia diritta SAE 3000

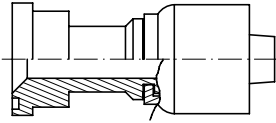

DN	Ø	Part n° Referencia	€
3/4"	38.1	681821212	17,85
1"	44.5	681821616	24,96
1"1/4	50.8	681822020	40,70

## Brida recta SAE 6000 PSI

One piece 6000 PSI SAE Straight Flange / Code 62

Bride SAE droite série 6000 PSI

Flangia diritta SAE 6000

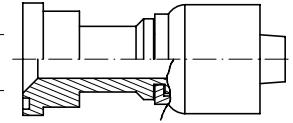

DN	Ø	Part n° Referencia	€
3/4"	41,3	682821212	18,98
1"	47,63	682821616	26,27
1"1/4	53,98	682822020	42,46

## Brida a 90° SAE 3000 PSI

One piece 3000 PSI SAE Flange (90° Elbow) / Code 61

Bride SAE coude 90° série 3000 PSI

Flangia 90° SAE 3000

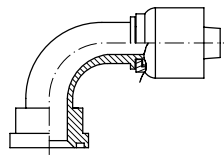

DN	Ø	Part n° Referencia	€
3/4"	38.1	681831212	22,76
1"	44.5	681831616	31,79
1"1/4	50.8	681832020	50,35

## Brida a 90° SAE 6000 PSI

One piece 6000 PSI SAE Flange (90° Elbow) / Code 62

Bride SAE coude 90° série 6000 PSI

Flangia 90° SAE 6000

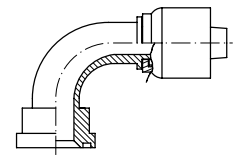

DN	Ø	Part n° Referencia	€
3/4"	41.3	682831212	24,15
1"	47.6	682831616	33,81
1"1/4	54	682832020	52,45

## Brida a 45° SAE 3000 PSI

One piece 3000 PSI SAE Flange (45° Elbow) / Code 61

Bride SAE coude 45° série 3000 PSI

Flangia 45° SAE 3000

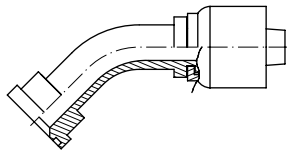

DN	Ø	Part n° Referencia	€
3/4"	38.1	681841212	22,76
1"	44.5	681841616	31,79
1"1/4	50.8	681842020	50,35

## Brida a 45° SAE 6000 PSI

One piece 6000 PSI SAE Flange (45° Elbow) / Code 62

Bride SAE coude 45° série 6000 PSI

Flangia 45° SAE 6000

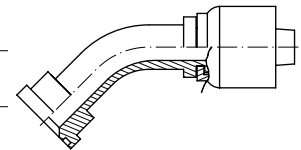

DN	Ø	Part n° Referencia	€
3/4"	41,3	682841212	24,15
1"	47,6	682841616	33,81
1"1/4	54	682842020	52,45

# Conexiones Una sola pieza Serie BW

One piece fittings BW series  
Embouts une seule pièce Série BW  
Raccordi BW - 1 pezzo

## Hembras giratorias Métricas cono 24° con junta tórica

Metric swivel female 24° seat with o'ring

Femelle Métrique 24° avec o'ring

Femmina Metrica sede 24° con o'ring

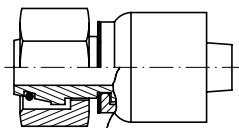

DN	THREAD ROSCA	Part n° Referencia	€
3/4"	M36X2	68204362512	19,07
1"	M42X2	68204423016	25,57
1"1/4	M52X2	68204523820	43,14

## Hembras giratorias 90° Métricas cono 24° con junta tórica

Metric swivel female 24° seat with o'ring (90° Elbow)

Coude 90° femelle Métrique 24° avec o'ring

Femmina Metrica 90° sede 24° con o'ring

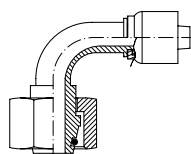

DN	THREAD ROSCA	Part n° Referencia	€
3/4"	M36X2	68205362512	23,79
1"	M42X2	68205423016	36,27
1"1/4	M52X2	68205523820	59,71

## Hembras giratorias rectas BSP cono 60°

BSP Swivel female 60° cone

Femelle tournante gaz cyl BSP 60°

Femmina diritta BSP sede 60°

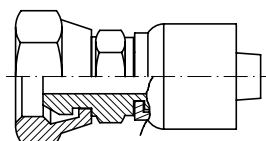

DN	THREAD ROSCA	Part n° Referencia	€
3/4"	3/4" BSP	681101212	14,05
1"	1" BSP	681101616	22,11
1"1/4	1"1/4 BSP	681102020	35,61

## Hembras giratorias 90° BSP cono 60°

BSP Swivel female 60° cone (90° Elbow)

Coude 90° femelle tournante gaz cyl BSP 60°

Femmina a 90° BSP sede 60°

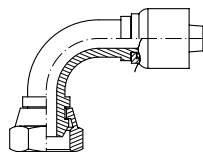

DN	THREAD ROSCA	Part n° Referencia	€
3/4"	3/4" BSP	681071212	19,81
1"	1" BSP	681071616	30,20
1"1/4	1"1/4 BSP	681072020	49,51

## Hembras giratorias 45° Métricas cono 24° con junta tórica

Metric swivel female 24° seat with o'ring (45° Elbow)

Coude 45° femelle Métrique 24° avec o'ring

Femmina Metrica 45° sede 24°

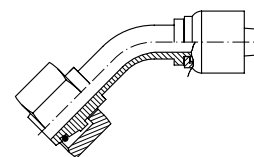

DN	THREAD ROSCA	Part n° Referencia	€
3/4"	M36X2	68206362512	23,79
1"	M42X2	68206423016	33,24
1"1/4	M52X2	68206523820	59,71

## Machos fijos Métricos cono 24°

Metric male stud 24° cone

Mâle Métrique cone 24°

Maschio Metrico sede 24° con o'ring

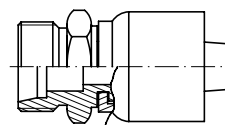

DN	THREAD ROSCA	Part n° Referencia	€
3/4"	M36X2	68203362512	18,04
1"	M42X2	68203423016	26,15

## Hembras giratorias 45° BSP cono 60°

BSP Swivel female 60° cone (45° Elbow)

Hembras giratorias 45° BSP cono 60°

Femmina a 45° BSP sede 60°

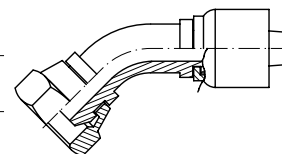

DN	THREAD ROSCA	Part n° Referencia	€
3/4"	3/4" BSP	681081212	19,81
1"	1" BSP	681081616	30,20
1"1/4	1"1/4 BSP	681082020	54,55

## Macho BSP cono 60°

BSP Male 60°

Mâle gaz cylindrique BSP 60°

Maschio BSP cilindrico sede 60°

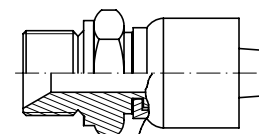

DN	THREAD ROSCA	Part n° Referencia	€
3/4"	3/4" BSP	681121212	16,45
1"	1" BSP	681121616	24,78
1"1/4	1"1/4 BSP	681122020	44,80

# Conexiones Reusables

Reusable series fittings  
Embouts Récuperables  
Raccordi serie Recuperabile

## Casquillos R1A

Ferrules R1A

Jupes à visser R1A

Boccola R1A

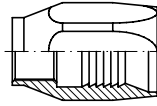

DN	Part nº Referencia	€
1/4"	A1G-4 R1	3,20
3/8"	A1G-6 R1	4,07
1/2"	A1G-8 R1	5,07
5/8"	A1G-10 R1	9,77
3/4"	A1G-12 R1	10,33

## Casquillos R1AT

Ferrules R1AT

Jupes à visser R1AT

Boccola R1AT

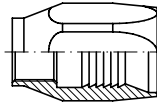

DN	Part nº Referencia	€
1/4"	A1G-4 R1T	4,55
3/8"	A1G-6 R1T	7,50
1/2"	A1G-8 R1T	6,96

## Casquillos R2A

Ferrules R2A

Jupes à visser R2A

Boccola R2A

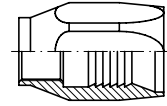

DN	Part nº Referencia	€
1/4"	A1G-4 R2	3,20
5/16"	A1G-5 R2	3,29
3/8"	A1G-6 R2	4,26
1/2"	A1G-8 R2	5,60
5/8"	A1G-10 R2	9,77
3/4"	A1G-12 R2	10,33
1"	A1G-16 R2	25,76

## Casquillos R2AT

Ferrules R2AT

Jupes à visser R2AT

Boccola R2AT

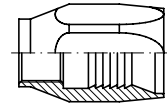

DN	Part nº Referencia	€
1/4"	A1G-4 R2T	4,21
3/8"	A1G-6 R2T	5,62
1/2"	A1G-8 R2T	6,35

## Hembras giratorias rectas BSP cono 60°

BSP Swivel female 60° cone

Femelle tournante gaz cyl BSP 60°

Femmina diritta recuperabile BSP sede 60°

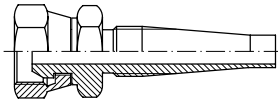

DN	THREAD ROSCA	Part nº Referencia	€
1/4"	1/4" BSP	A3G-4	3,81
1/4"	3/8" BSP	A3G-6-4	6,66
5/16"	3/8" BSP	A3G-6-5	6,66
3/8"	3/8" BSP	A3G-6	4,94
3/8"	1/2" BSP	A3G-8-6	9,63
1/2"	1/2" BSP	A3G-8	6,78
1/2"	3/4" BSP	A3G-12-8	14,88
3/4"	3/4" BSP	A3G-12	14,51
5/8"	3/4" BSP	A3G 12-10	21,89
1"	1" BSP	A3G-16	24,87

## Hembras giratorias 90° BSP cono 60°

BSP Swept 90° elbow 60° cone

Femelle tournante coude 90° gaz cyl BSP 60°

Femmina a 90° recuperabile BSP sede 60°

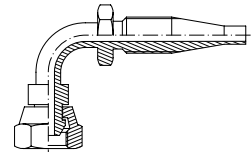

DN	THREAD ROSCA	Part nº Referencia	€
1/4"	1/4" BSP	A90G-4	6,66
5/16"	3/8" BSP	A90G-6-5	7,43
3/8"	3/8" BSP	A90G-6	7,43
3/8"	1/2" BSP	A90G-8-6	9,47
1/2"	1/2" BSP	A90G-8	9,92
1/2"	3/4" BSP	A90G-12-8	13,70
3/4"	3/4" BSP	A90G-12	16,95
3/4"	1" BSP	A90G-16-12	23,53
1"	1" BSP	A90G-16	31,12

# Conexiones Reusables

Reusable series fittings  
Embouts Récuperables  
Raccordi serie Recuperabile

## Machos rosca cilíndrica BSP cono 60°

BSP Male parallel 60° cone

Mâle gaz cyl BSP 60°

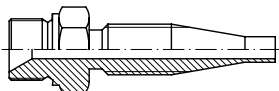

Maschio cilindrico recuperabile BSP sede 60°

DN	THREAD ROSCA	Part n° Referencia	€
1/4"	1/4" BSP	A2G-4	2,77
1/4"	3/8" BSP	A2G-6-4	4,59
5/16"	3/8" BSP	A2G-6-5	4,60
3/8"	3/8" BSP	A2G-6	3,89
3/8"	1/2" BSP	A2G-8-6	6,38
1/2"	1/2" BSP	A2G-8	5,43
1/2"	3/4" BSP	A2G-12-8	10,49
3/4"	3/4" BSP	A2G-12	10,49
5/8"	3/4" BSP	A2G-12-10	10,49
3/4"	1" BSP	A2G-16-12	18,40
1"	1" BSP	A2G-16	18,40

## Machos Stecko

Male Stecko connections

Mâle Stecko

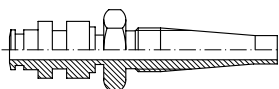

Maschio Stecko recuperabile

DN	STECKO	Part n° Referencia	€
1/4"	1/4"	S2G-4	3,80
1/4"	3/8"	S2G-6-4	6,50
1/2"	1/2"	S2G-8	3,15

Hasta fin de existencias / Until end of stock. / Jusqu'à la fin du stock. / Fino ad esaurimento scorta.

## Espigas lisas Métricas

Metric Standpipe

Embout lisse Métrique

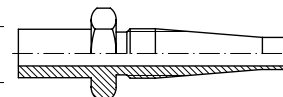

Estremità tubolare Metrica recuperabile

DN	PIPE TUBO	Part n° Referencia	€
1/4"	6	AE 6-4	9,29
1/4"	8	AE 8-4	9,29
1/4"	10	AE 10-4	10,54
5/16"	10	AE 10-5	10,54
3/8"	10	AE 10-6	13,92
5/16"	12	AE 10-8 *	3,49
5/16"	12	AE 12-5	13,92
3/8"	12	AE 12-6	13,92
1/2"	15	AE 15-8	16,11
1/2"	16	AE 16-8	16,11
5/8"	18	AE 18-10	19,13
5/8"	20	AE 20-10	19,13
3/4"	22	AE 22-12	22,89
3/4"	25	AE 25-12	22,89

\*Hasta fin de existencias. / \*Until end of stock. / \*Jusqu'à la fin du stock. / \*Fino ad esaurimento scorta.

## Orientables BSP

Banjo BSP

Banjo droit tube gaz cyl BSP

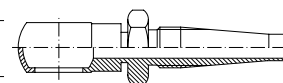

Raccordo ad occhio BSP recuperabile

DN	Ø	Part n° Referencia	€
1/4"	1/4" BSP	AOG-4	7,18
5/16"	3/8" BSP	AOG-6-5	9,37
3/8"	3/8" BSP	AOG-6	9,36
3/8"	1/2" BSP	AOG-8-6	13,27
1/2"	1/2" BSP	AOG-8	13,27
1/2"	3/4" BSP	AOG-12-8	28,30
3/4"	3/4" BSP	AOG-12	26,19
3/4"	1" BSP	AOG-16-12	49,02
1"	1" BSP	AOG-16	57,57

## Conexiones alta presión (700 Bar)

High pressure 700 Bar fittings

Embouts haute pression 700 Bar

Raccordi Altissima pressione (700 Bar)

### Manguera termoplástica 700 bar

Thermoplastic hose 700 bar

Tuyau thermoplastique haute pression 700 bar



Tube termoplastico 700 bar

DN	Ø INNER Ø INT.	Part n° Referencia	€
1/4"	6,6	MT70004	19,74
3/8"	9,8	MT70006	46,54

### Casquillos manguera 700 bar tipo MT700

Ferrules for thermoplastic hose 700 bar MT700 type

Jupes à sertir thermoplastique 700 bar type MT700

Boccole per tubo termoplastico 700 bar tipo MT700

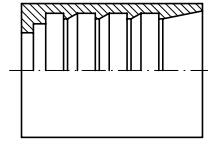

DN	Part n° Referencia	€
1/4"	710120400	1,78
3/8"	710120600	2,56

### Hembra giratoria recta BSP 60°

BSP Swivel female 60° cone

Embout thermoplastique 700 bar femelle tournante gaz cyl BSP 60°

Femmina diritta BSP sede 60°

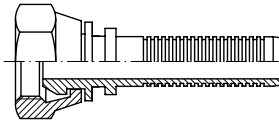

DN	THREAD ROSCA	Part n° Referencia	€
1/4"	1/4" BSP	741000404	4,42
3/8"	3/8" BSP	741000606	3,54

### Macho BSP 60°

BSP Male parallel 60° cone

Embout thermoplastique 700 bar mâle fixe gaz cyl BSP 60°

Maschio cilindrico BSP sede 60°

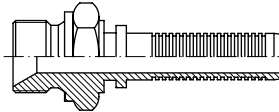

DN	THREAD ROSCA	Part n° Referencia	€
1/4"	1/4" BSP	741120404	3,28
3/8"	3/8" BSP	741120606	3,84

### Macho NPT

NPT Male thread

Embout thermoplastique 700 bar mâle fixe gaz conique NPT

Maschio conico NPT

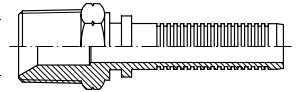

DN	THREAD ROSCA	Part n° Referencia	€
1/4"	1/4" NPT	741610404	2,64
1/4"	3/8" NPT	741610604	3,12
3/8"	3/8" NPT	741610606	3,12



AMPLIAMOS INSTALACIONES  
WE'RE EXPANDING OUR FACILITIES

18.500m<sup>2</sup>



- $\emptyset$  →  $\emptyset$  Prensado ·  $\emptyset$  Crimping ·  $\emptyset$  de sertissage  
 E → Pelado Exterior · Ext. Skive · Dénudage extérieur  
 I → Pelado Interior · Int. Skive · Dénudage intérieur

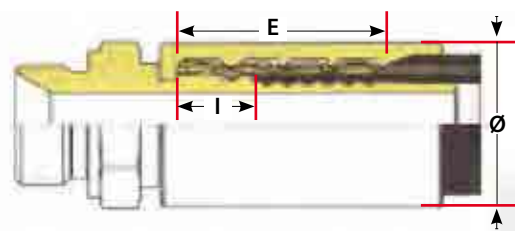

Los datos que aparecen son recomendados para nuestras mangueras TRΔLE/TRIAGLE (MS/ML)

This crimping chart is the one we recommend for our hoses TRΔLE/TRIAGLE (MS/ML) · Ce tableau de sertissage est celui que nous recommandons pour nos tuyaux TRΔLE/TRIAGLE (MS/ML)

Los  $\emptyset$  de Prensado deben ser verificados con los calibres pasa / no pasa

The crimping diameters must be verified with the go/ no go gauge · Les diamètres de sertissage doivent être vérifiées avec le calibre entre/ n'entre pas

Las dimensiones indicadas son mm

The dimensions are indicated in mm · Les dimensions son indiquées en mm

Para consultar  $\emptyset$  de manguera ver tabla dimensional de mangueras

To consult hose diameter see the dimensional hoses chart · Pour consulter le  $\emptyset$  du tuyau, voir la table dimensionnelle des tuyaux

Datos de tablas siempre actualizados en nuestra web [www.dicsaes.com](http://www.dicsaes.com)

Crimping information always updated on our website [www.dicsaes.com](http://www.dicsaes.com) · Information des tableaux toujours actualisés sur notre web [www.dicsaes.com](http://www.dicsaes.com)

## Manguera Hidráulica. Tabla de Prensado para Casquillos en Acero Carbono.

Hydraulic Hoses. Crimping chart for carbon steel.

	Manguera Hose	Serie Casquillo Ferrule	DN mm	5	6	8	10	12	16	19	25	31	38	51	
			Pulgadas	3/16"	1/4"	5/16"	3/8"	1/2"	5/8"	3/4"	1"	1"1/4"	1"1/2"	2"	
Conexiones Estándar · Standard Series	EN 857 / 1SC <b>1SC</b>	SC2112	$\emptyset$		16,7	16,1	18,3	23,6	27,3	30,7	39				
				EN 853 1SN/ SAE 100 R1AT <b>2230</b>		16,3	16,9	18,6	23	28	30,9	39			
	EN 857 / 2SC EN 857 2SC <b>2SC 2SCNL</b>	DI2212	$\emptyset$		18,1	18,8	21,1	23,7	27,6	31,2	39				
					17,7		20,2	23		30,9	39				
	EN 853 1SN/ SAE 100 R1AT <b>2230</b>	DI2212	$\emptyset$		15,7	17,4	18,6	20,8	22,9	27	30	39	47,8	56	70
				EN 853 2SN/ SAE 100 R2AT <b>3511</b>		16,2	18	19,8	21,8	24,2	28,2	32,1	40,5	50,8	59
	EN 853 2ST/ SAE 100 R2A <b>3509</b>	DI1224	$\emptyset$	18,2	17,6	20	22,5	26,3	29,1	33,4	42,2	51	59	72,3	
			E		21	22	23	23,5	24,5	31,5	38	45	49	60	
			$\emptyset$		18,8		23,4	26,5	29,7	34,4	42	51,7	59,7	73	
			E		21		23	23,5	24,5	31,5	38	45	49	60	
EN 856 R12/ SAE 100 R12 <b>4612</b>	DI1224	$\emptyset$				23,3	26,7	29,3	34,4	42,2	50,5	58,3			
		E				23	23,5	24,5	31,5	38	45	49			
Conexiones Interlock · Interlock Series	EN 856 4SH <b>4569</b>	A61010	$\emptyset$							35,5	42	50	57	74	
			E							52	57	67	77	82	
			I							17	18	21	24	26	
	EN 856 R13/ SAE 100 R13 <b>4713</b>	A61010	$\emptyset$								36	42,5			
			E								52	57			
			I								17	18			
		61010	$\emptyset$										55	64	79
			E										67	77	82
			I										21	24	26
	SAE 100 R15 <b>4815</b>	A610	$\emptyset$									42			
			E									57			
			I									18			
	610	$\emptyset$										54,5	64		
		E										64	77		
		I										21	24		

## Manguera Termoplástica. Tabla de Prensado para Casquillos en Acero Carbono.

Thermoplastic Hoses. Crimping chart for carbon steel.

	Manguera Hose	Serie Casquillo Ferrule	DN mm	3	5	6	8	10	12	16	19	25	31	38	51	63
			Pulgadas	1/8"	3/16"	1/4"	5/16"	3/8"	1/2"	5/8"	3/4"	1"	1"1/4"	1"1/2"	2"	2" 1/2"
Conexiones Estándar · Standard Series	PTFE FHL <b>M29000</b>	21040	∅		11,5	13	13,8	15,5	20,5	23,5	27	34				
	PTFE FHM 2 MALLAS <b>M29012</b>	DI23	∅			13,6	14,6	17,5			27	34,5				
		21040	∅						20,7	25,2						
	PTFE CONV <b>M2920</b>	21041	∅			12,2	14	16,8	20,2	24	26,7	34	39	48,2	60,2	74
	SAE100 R7 <b>MT07</b>	DI23	∅	11	11,2	14,9	16,1	18,6	23	26	28,4	37				
	SAE100 R8 <b>MT08</b>		∅		11,3	14,3	15,7	18,3	23	26	29	37				
	EMM <b>MT09</b>		∅		11,3	14,5	15,8	18,5	22	25	28	36,5				
EMM PINTURA <b>MT099</b>	∅			11,3	14,5	16,5	18,4	22		27,8						
Pint	E2MM PINTURA <b>MT299</b>	DI1224	∅			17,3	19	22	26		30,3	41				
Alta	ALTISIMA PRESION <b>M700</b>	71012	∅			16,6		22,8								
Mini	MINIMESS <b>MT01</b>	555	∅	7												

Tablas de prensado Series BW y Series 43 en nuestra web [www.dicsaes.com](http://www.dicsaes.com)

Crimping BW and 43 series information on our website [www.dicsaes.com](http://www.dicsaes.com)

Information des séries BW et séries 43 actualisés sur notre web [www.dicsaes.com](http://www.dicsaes.com)

Datos de tablas siempre actualizados en nuestra web [www.dicsaes.com](http://www.dicsaes.com)

Crimping information always updated on our website [www.dicsaes.com](http://www.dicsaes.com)

Information des tableaux toujours actualisés sur notre web [www.dicsaes.com](http://www.dicsaes.com)

## Metrología

*Flow measuring*

Test du circuit hydraulique

*Test per circuiti idraulici.*

### Racores de control

*Test couplings*

Prises de contrôle

*Prese di pressione*

82

### Tomas de manómetros

*Micro-hose fittings*

Embouts manomètres

*Raccordi per manometri*

85

### Manómetros y vacuómetros

*Pressure and vacuum gauges*

Manomètres et vacuomètres

*Manometri e vacuometri*

87

### Medidores de caudal

*Flow tester*

Débitmètres

*Indicatori di flusso*

89

3

# Racores de control

Test couplings  
Prises de contrôle  
Prese di pressione

## ■ Tomas de presión 16x1.5 / Check couplings for manometers 16x1.5 / Prises de pression 16x1.5 / Prese di pressione 16x1.5

82

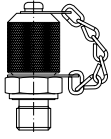

MPL M

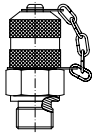

MPL

## ■ Tomas de presión 16x2 / Check couplings for manometers 16x2 / Prises de pression 16x2 / Prese di pressione 16x2

82

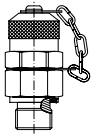

MPR C/J

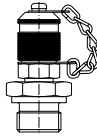

MPR G

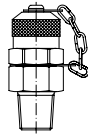

MPR BSPT

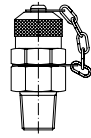

MPR NPT

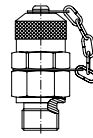

MPR M

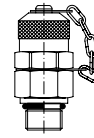

MPR A

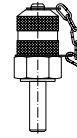

MPR TUB

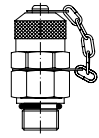

MPR UNF

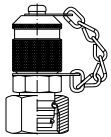

MPR TLM CM

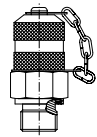

MPR M CM

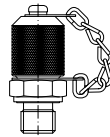

MPR CJ CM

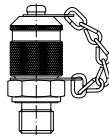

MPR G CM

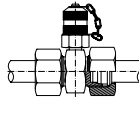

MPR DL CM

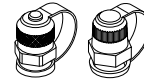

27C/28C

## ■ Accesorios / adaptadores / Accessoires / adaptors / Accessoires / adapteurs minimes / Accessori / adattatori

84

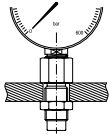

MPR PT BSP

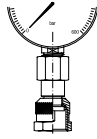

MPD BSP

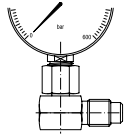

MPD 90 BSP

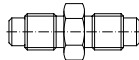

MPU

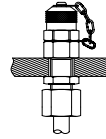

MPR PT

# Tomas de manómetros

Micro-hose fittings  
 Embouts manomètres  
 Raccordi per manometri

■ Mangueras para tomas de manómetro / Hoses for check couplings for manometers / Tuyaux capillaires minimes / Tubi per prese di pressione

85



MT010

■ Conexiones para prensar / Crimp fittings / Embouts à sertir minimes / Raccordi a pressare

85

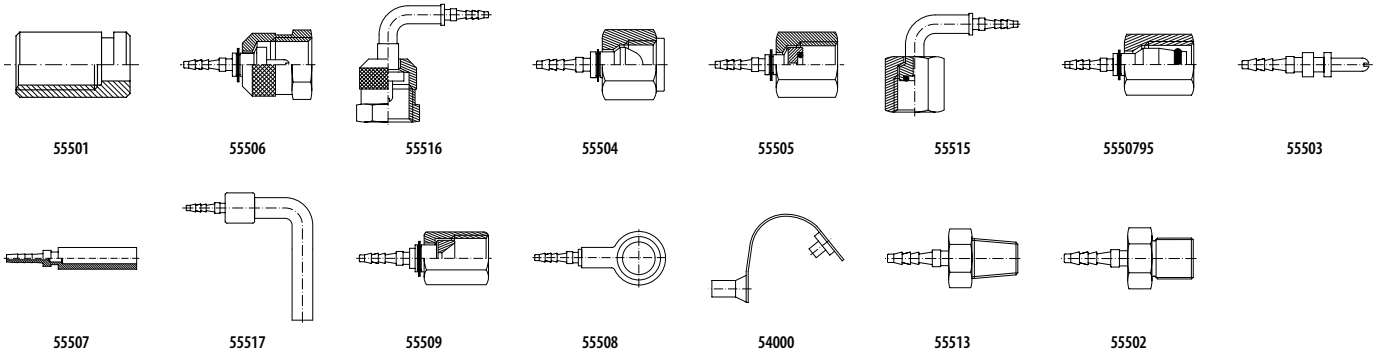

# Manómetros y vacuómetros

*Pressure and vacuum gauges*  
*Manomètres et vacuomètres*  
*Manometri e vacuometri*

## ■ Manómetros / Pressure gauges / Manomètres / Manometri

87



MFI63...V



MFI63...-DB



MFI CO



MFI100...V



MFI100...-DB



MANDIG

## ■ Vacuómetros / Vacuum gauges / Vacuomètres / Vacuometri

88



VAC6304



MFIVA

## ■ Equipos de medición / Check cases / Équipements de mesure / Valigetta per rilevamento di pressione

88



CBOXMED F



CBOX0001



CBOX0003



CBOX0002



# Medidores de caudal

Flow tester  
Débitmètres  
Indicatori di flusso

## ■ Caudalímetros 250 bar / Flow tester 250 bar / Débitmètres 250 bar / Flussostati 250 bar

89



WPB3A6H



WPB4A6H



WPB5A6H

## ■ Caudalímetros 300-400 bar / Flow tester 300-400 bar / Débitmètres 300-400 bar / Flussostati 300-400 bar

89



FT5758



FT6068



FT5594

## ■ Foto-tacómetro / Photo-tachometer / Photo-tachymètre / Foto-tachimetro

89



DT

Hoses

Flexible hose fittings

Flow measuring

Processing machine  
for flexible hoses

# Racores de control

Test couplings  
Prises de contrôle  
Prese di pressione

## Racor de control rosca Métrica DIN 3852 (tapón metálico)

Check coupling male metric thread (metallic cap)

Prise de pression métrique (capuchon métallique)

Prese di pressione Metrica DIN 3852 (tappo metallico)

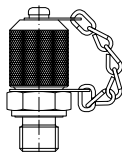

THREAD ROSCA	DESCRIPTION DESCRIPCIÓN	Part nº Referencia	€
M10X1	16x1.5	MPL M 10X1 CM	18,41

Otras figuras, consultar / For other designs, please consult us / Pour d'autres figures, consultez-nous / Per altre figure, vi preghiamo di consultarci

## Racor de control rosca BSP (tapón metálico)

Check coupling BSP (metallic cap)

Prise de pression BSP (capuchon métallique)

Prese di pressione BSP (tappo metallico)

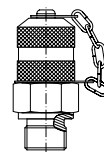

THREAD ROSCA	DESCRIPTION DESCRIPCIÓN	Part nº Referencia	€
1/8" BSP	16x1.5	MPL 1/8 G CM	17,81
1/4" BSP	16x1.5	MPL 1/4 G CM	19,01

Otras figuras, consultar / For other designs, please consult us / Pour d'autres figures, consultez-nous / Per altre figure, vi preghiamo di consultarci

## Racor de control rosca BSP con junta tórica (tapón plástico)

Check coupling male thread BSP with o'ring (plastic cap)

Prise de pression avec o'ring (capuchon plastique)

Prese di pressione BSP con o'ring (tappo plastica)

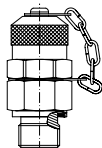

THREAD ROSCA	DESCRIPTION DESCRIPCIÓN	Part nº Referencia	€
1/8" BSP	16x2	MPR 1/8 C/J	6,30
1/4" BSP	16x2	MPR 1/4 C/J	6,46
3/8" BSP	16x2	MPR 3/8 C/J	6,83
1/2" BSP	16x2	MPR 1/2 C/J	7,09

## Racor de control rosca NPT (tapón plástico)

Check coupling male thread NPT (plastic cap)

Prise de pression NPTF (capuchon plastique)

Prese di pressione NPTF (tappo plastica)

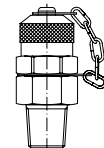

THREAD ROSCA	DESCRIPTION DESCRIPCIÓN	Part nº Referencia	€
1/8" NPT	16x2	MPR 1/8 NPT	7,75
1/4" NPT	16x2	MPR 1/4 NPT	7,75
3/8" NPT	16x2	MPR 3/8 NPT	7,93

## Racor de control rosca BSP (tapón plástico)

Check coupling male thread BSP (plastic cap)

Prise de pression (capuchon plastique)

Prese di pressione BSP (tappo plastica)

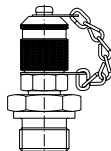

THREAD ROSCA	DESCRIPTION DESCRIPCIÓN	Part nº Referencia	€
1/8" BSP	16x2	MPR 1/8 G	6,30
1/4" BSP	16x2	MPR 1/4 G	6,46
3/8" BSP	16x2	MPR 3/8 G	6,83
1/2" BSP	16x2	MPR 1/2 G	7,09

## Racor de control rosca Métrica DIN 3852 (tapón plástico)

Check coupling male metric thread (plastic cap)

Prise de pression métrique (capuchon plastique)

Prese di pressione Metrica DIN 3852 (tappo plastica)

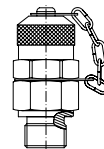

THREAD ROSCA	DESCRIPTION DESCRIPCIÓN	Part nº Referencia	€
M12X1.5	16x2	MPR M12X1.5	7,75
M14X1.5	16x2	MPR M14X1.5	7,75
M16X1.5	16x2	MPR M16X1.5	7,93

## Racor de control rosca Métrica (tapón plástico)

Check coupling male metric thread (plastic cap)

Prise de pression métrique (capuchon plastique)

Prese di pressione Metrica (tappo plastica)



THREAD ROSCA	DESCRIPTION DESCRIPCIÓN	Part nº Referencia	€
M8X1	16x2	MPR A 8X1	7,67
M10X1	16x2	MPR A 10X1	7,67
M10X1.25	16x2	MPR A 10X1.25	7,67

## Racor de control rosca cónica BSPT (tapón plástico)

Check coupling male BSP tapered (plastic cap)

Prise de pression BSPT (capuchon plastique)

Prese di pressione conica BSPT (tappo plastica)

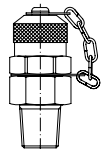

THREAD ROSCA	DESCRIPTION DESCRIPCIÓN	Part nº Referencia	€
1/8" BSPT	16x2	MPR 1/8 BSPT	7,75
1/4" BSPT	16x2	MPR 1/4 BSPT	7,75
3/8" BSPT	16x2	MPR 3/8 BSPT	7,93

# Racores de control

Test couplings

Prises de contrôle

Prese di pressione

## Racor de control tubular Métrico (tapón plástico)

Check coupling male metric tubular (plastic cap)

Prise de pression avec embout lisse (capuchon plastique)

Prese di pressione con tubolare Metrico (tappo plastica)

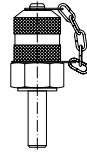

PIPE TUBO	DESCRIPTION DESCRIPCIÓN	Part n° Referencia	€
6	16x2	MPR TUB.6	7,50
8	16x2	MPR TUB.8	7,50
10	16x2	MPR TUB.10	7,50
12	16x2	MPR TUB.12	7,50
15	16x2	MPR TUB.15	7,50

## Racor de control rosca SAE - UNF (tapón plástico)

Check coupling male thread UNF (plastic cap)

Prise de pression filetage SAE/UNF (capuchon plastique)

Prese di controllo SAE - UNF (tappo plastica)

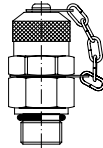

THREAD ROSCA	DESCRIPTION DESCRIPCIÓN	Part n° Referencia	€
7/16" 20h UNF	16x2	MPR 7/16 UNF	7,67
1/2" 20h UNF	16x2	MPR 1/2 UNF	7,67
9/16" 18h UNF	16x2	MPR 9/16 UNF	7,67

## Racor de control hembra giratoria Métrica con junta (tapón metálico)

Check coupling Metric swivel female + o'ring (metallic cap)

Prise de pression femelle tournante Métrique + o'ring (capuchon métallique)

Prese di pressione femmina girevole Metrica con o'ring (tappo metallico)

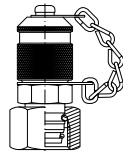

PIPE TUBO	THREAD ROSCA	DESCRIPTION DESCRIPCIÓN	Part n° Referencia	€
6L	M12X1.5	16x2	MPR TLM 6L CM	9,98
8L	M14X1.5	16x2	MPR TLM 8L CM	10,24
10L	M16X1.5	16x2	MPR TLM 10L CM	10,51
12L	M18X1.5	16x2	MPR TLM 12L CM	10,77
15L	M22X1.5	16x2	MPR TLM 15L CM	11,03

Otras medidas, consultar / For other dimensions, please consult us / Pour d'autres dimensions, consultez-nous / Per altre dimensioni, vi preghiamo di consultarci

## Racor de control macho Métrico con junta (tapón metálico)

Check coupling metric male + o'ring (metallic cap)

Prise de pression mâle + o'ring (capuchon métallique)

Prese di pressione maschio Metrico con o'ring (tappo metallico)

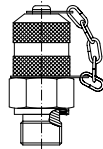

THREAD ROSCA	DESCRIPTION DESCRIPCIÓN	Part n° Referencia	€
M10X1	16x2	MPR M 10X1 CM	8,35
M12X1.5	16x2	MPR M 12X1.5 CM	8,35

## Racor de control rosca BSP con junta tórica (tapón metálico)

Check coupling BSP with o'ring (metallic cap)

Prise de pression BSP avec o'ring (capuchon métallique)

Prese di pressione BSP con o-ring (tappo metallico)

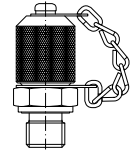

THREAD ROSCA	DESCRIPTION DESCRIPCIÓN	Part n° Referencia	€
1/8" BSP	16x2	MPR 1/8 C/J CM	8,35
1/4" BSP	16x2	MPR 1/4 C/J CM	7,30

## Racor de control rosca BSP (tapón metálico)

Check coupling BSP (metallic cap)

Prise de pression BSP (capuchon métallique)

Prese di pressione BSP (tappo metallico)

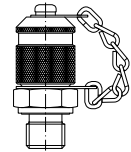

THREAD ROSCA	DESCRIPTION DESCRIPCIÓN	Part n° Referencia	€
1/8" BSP	16x2	MPR 1/8 G CM	17,21
1/4" BSP	16x2	MPR 1/4 G CM	13,62

## Racor de control intermedio (tapón metálico)

Half-way check coupling (metallic cap)

Prise de pression intermédiaire (capuchon métallique)

Prese di pressione intermedio (tappo metallico)

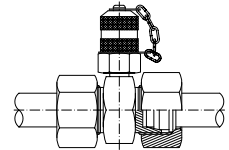

PIPE TUBO	DESCRIPTION DESCRIPCIÓN	Part n° Referencia	€
6L	16x2	MPR DL 6 CM	14,29
8L	16x2	MPR DL 8 CM	15,02
10L	16x2	MPR DL 10 CM	15,50
12L	16x2	MPR DL 12 CM	16,02
15L	16x2	MPR DL 15 CM	16,86

## Capuchón protector toma de presión

Protective cap - check coupling for manometer

Capuchon Minimess

Cappuccio di protezione per presa di pressione

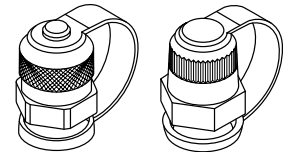

CAPS CAPUCHON	Part n° Referencia	€
CARBON STEEL	27CA0000	2,08
PLASTIC	28CP0000	1,58

# Racores de control

Test couplings  
Prises de contrôle  
Prese di pressione

## Conex. manómetro-pasatabiques BSP

Check coupling BSP bulkhead for manometer

Prise de pression passe cloison sans capuchon

Raccordo Manometro - passaparete maschio BSP

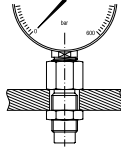

THREAD ROSCA		Part n° Referencia	€
1/4" BSP	M16x2	MPR PT 1/4 BSP	9,46
1/2" BSP	M16x2	MPR PT 1/2 BSP	11,56

## Conex. manómetro - toma de control

Check coupling for manometer

Raccord de contrôle direct à manomètre sans capuchon

Raccordo manometro - presa di pressione

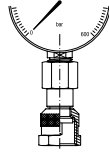

THREAD ROSCA		Part n° Referencia	€
1/4" BSP	M16x2	MPD 1/4 BSP	11,58
1/2" BSP	M16x2	MPD 1/2 BSP	15,52

## Conex. manómetro-hembra 90° BSP

Check coupling 90° BSP swivel female for manometer

Raccord de contrôle 90° orientable sans capuchon direct à manomètre

Raccordo manometro - femmina a 90° BSP

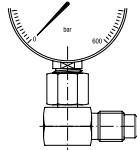

THREAD ROSCA		Part n° Referencia	€
1/4" BSP	M 16x2	MPD 90 1/4 BSP	15,18
1/2" BSP	M 16x2	MPD 90 1/2 BSP	16,55

## Conex. manómetro M-M

Male-Male check coupling for manometer

Prise de pression manomètre Mâle-Mâle

Adattatore M-M presa di pressione per manometro

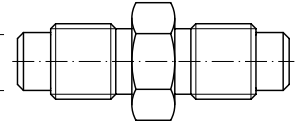

THREAD ROSCA		Part n° Referencia	€
M16X2	M16X1.5	MPU 16X2	18,56
M16X1.5	M16X1.5	MPU 16X1.5	18,31

## Conex. Métrica para manómetros

Metric check coupling for manometer

Prise de contrôle métrique pour manomètre

Presa de pressione metrica per manometro

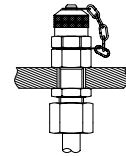

PIPE TUBO	THREAD ROSCA	Part n° Referencia	€
8S	M16X1.5	MPR PT 16X1.5	18,75
10S	M18X1.5	MPR PT 18X1.5	21,48

# Tomas de manómetros

Micro-hose fittings  
Embouts manomètres  
Raccordi per manometri

Hoses

Flexible hose fittings

Flow measuring

Processing machine for flexible hoses

## Mangueras Minimes

"Micro-Hose" hose

Tuyaux Minimes



Micro-tubo per presa di pressione

Ø INNER Ø INT.	Part n° Referencia	€
2	MT01002	3,00

## Casquillo manguera Minimes

Micro-hose ferrules

Jupe pour tuyau Minimes

Boccola per Micro-tubo

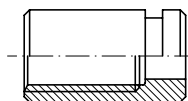

DN	Ø OUTER Ø EXT.	Ø INNER Ø INT.	Part n° Referencia	€
2	8	5.1	555010100	0,42

## Hembra giratoria de control

Check Metric swivel female Micro-hose

Embout femelle tournante de control Métrique Minimes

Presa di pressione femmina

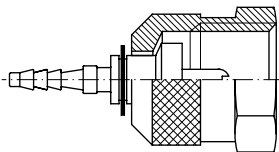

DN	THREAD ROSCA	Part n° Referencia	€
2	M16X1.5	555069521	4,57
2	M16X2	555069523	4,57

## Codo 90° hembra giratoria de control

90° Swivel female check coupling

Coude 90° prise de pression femelle tournante

Presa di pressione femmina 90° girevole

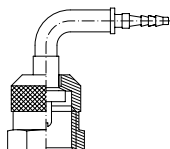

DN	THREAD ROSCA	Part n° Referencia	€
2	M16X2	555169523	34,23

## Hembra giratoria recta BSP

Straight swivel female BSP 60° cone Micro-hose

Embout femelle tournante gaz cyl BSP 60° Minimes

Femmina girevole BSP

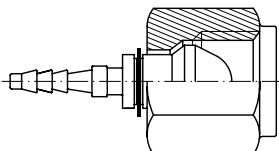

DN	THREAD ROSCA	Part n° Referencia	€
2	1/8" BSP	555040202	5,04
2	1/4" BSP	555040404	4,73
2	3/8" BSP	555040606	8,20

## Hembra asiento plano con junta manómetro

Swivel female flat seat with o'ring for manometer Micro-hose

Embout femelle tournante fond plat + o'ring pour manomètre Minimes

Femmina sede piana con o'ring per manometro

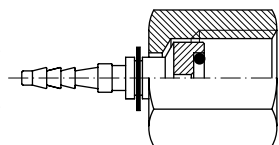

DN	THREAD ROSCA	Part n° Referencia	€
2	1/4" BSP	555050404	4,89
2	1/2" BSP	555050808	8,20

## Codo 90° hembra asiento plano con junta manómetro

90° Swivel female flat seat with o'ring for manometer

Coude 90° prise de pression femelle fond plat avec o'ring

Presa di pressione femmina 90° faccia piana con o'ring per manometro

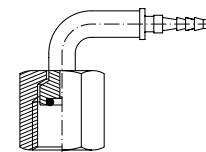

DN	THREAD ROSCA	Part n° Referencia	€
2	1/4" BSP	555150404	33,92

## Hembra giratoria Métrica con junta

Metric swivel female with o'ring

Embout femelle tournante Métrique 24° pour raccord de control + o'ring minimes

Femmina Metrica 24° con o'ring

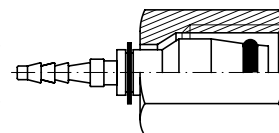

DN	PIPE TUBO	THREAD ROSCA	Part n° Referencia	€
2	6L	M12X1.5	555079510	4,10
2	6S	M14X1.5	555079511	4,10
2	8L	M14X1.5	555079512	4,41
2	8S	M16X1.5	555079523	4,57
2	10L	M16X1.5	555079525	7,14

## Macho de control

Straight Micro-hose check male

Embout mâle manomètre

Presa di pressione maschio

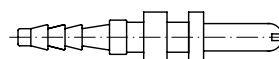

DN	Part n° Referencia	€
2	555030325	4,41

# Tomas de manómetros

Micro-hose fittings  
Embouts manomètres  
Raccordi per manometri

## Espiga lisa Métrica

Metric standpipe Micro-hose

Embout lisse Métrique Minimess

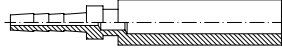

Estremità tubolare Metrica

DN	PIPE TUBO	Part n° Referencia	€
2	6	555070600	2,63
2	8	555070800	2,52

## Espiga a 90° lisa Métrica

90° Metric standpipe Micro-hose

Embout lisse coude 90° Métrique Minimess

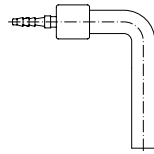

Estremità tubolare a 90° Metrica

DN	PIPE TUBO	Part n° Referencia	€
2	6	555170600	7,88

## Hembra giratoria recta JIC 37°

Straight swivel female JIC 37° Micro-hose

Embout femelle tournante JIC 37° Minimess

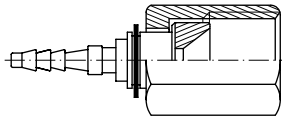

Femmina diritta JIC 37°

DN	THREAD ROSCA	Part n° Referencia	€
2	7/16" 20h UNF	555090700	3,78
2	1/2" 20h UNF	555090800	5,04
2	9/16" 18h UNF	555090900	5,52

## Orientable Métrico

Metric Banjo Micro-hose

Embout Banjo Métrique Minimess

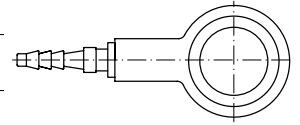

Raccordo ad occhio Metrico

DN	THREAD ROSCA	Part n° Referencia	€
2	M10X1	555081000	6,30

## Protector de polvo

Dust protector

Protecteur de poussière

Protezione per polvere

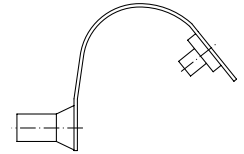

DESCRIPTION DESCRIPCIÓN	Part n° Referencia	€
PLASTIC	54000000P	0,17

## Macho NPT

Male NPT

Mâle NPT

Maschio NPT

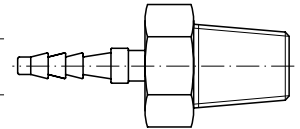

DN	THREAD ROSCA	Part n° Referencia	€
2	1/8" NPT	555130200	7,56

## Macho BSP

BSP Male

Mâle BSP

Maschio BSP

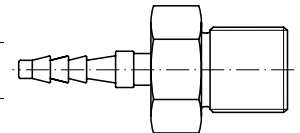

DN	THREAD ROSCA	Part n° Referencia	€
2	1/8" BSP	555020202	6,62
2	1/4" BSP	555020404	*

# Manómetros y vacuómetros

Pressure and vacuum gauges  
Manomètres et vacuomètres  
Manometri e vacuometri

Hoses

Flexible hose fittings

Flow measuring

Processing machine for flexible hoses

## Manómetro DN 63 vertical con glicerina (1/4" BSP)

Pressure gauge DN 63 vertical connection with glycerin (1/4" BSP)

Manomètre DN 63 sortie verticale avec glycérine (1/4" BSP)

Manometro DN 63 radiale a bagno di glicerina (1/4" BSP)



THREAD ROSCA	SCALE (bar) ESCALA (bar)	Part nº Referencia	€
1/4" BSP	0-1	MFI6304001V	14,81
1/4" BSP	0-2.5	MFI63042.5V	14,81
1/4" BSP	0-4	MFI6304004V	14,81
1/4" BSP	0-6	MFI6304006V	14,81
1/4" BSP	0-10	MFI6304010V	14,81
1/4" BSP	0-12	MFI6304012V	14,81
1/4" BSP	0-16	MFI6304016V	14,81
1/4" BSP	0-20	MFI6304020V	14,81
1/4" BSP	0-25	MFI6304025V	14,81
1/4" BSP	0-40	MFI6304040V	14,81
1/4" BSP	0-60	MFI6304060V	14,81
1/4" BSP	0-100	MFI6304100V	14,81
1/4" BSP	0-160	MFI6304160V	14,81
1/4" BSP	0-250	MFI6304250V	14,81
1/4" BSP	0-315	MFI6304315V	14,81
1/4" BSP	0-400	MFI6304400V	14,81
1/4" BSP	0-600	MFI6304600V	14,81

## Manómetro DN 100 vertical con glicerina (1/2" BSP)

Pressure gauge DN 100 vertical connection with glycerin (1/2" BSP)

Manomètre DN 100 sortie verticale avec glycérine (1/2" BSP)

Manometro DN 100 radiale a bagno di glicerina (1/2" BSP)



THREAD ROSCA	SCALE (bar) ESCALA (bar)	Part nº Referencia	€
1/2" BSP	0-1	MFI10008001V	39,36
1/2" BSP	0-2.5	MFI1000802.5V	39,36
1/2" BSP	0-4	MFI10008004V	39,36
1/2" BSP	0-6	MFI10008006V	39,36
1/2" BSP	0-10	MFI10008010V	39,36
1/2" BSP	0-12	MFI10008012V	39,36
1/2" BSP	0-16	MFI10008016V	39,36
1/2" BSP	0-20	MFI10008020V	39,36
1/2" BSP	0-25	MFI10008025V	39,36
1/2" BSP	0-40	MFI10008040V	39,36
1/2" BSP	0-60	MFI10008060V	39,36
1/2" BSP	0-100	MFI10008100V	39,36
1/2" BSP	0-160	MFI10008160V	39,36
1/2" BSP	0-250	MFI10008250V	39,36
1/2" BSP	0-315	MFI10008315V	39,36
1/2" BSP	0-400	MFI10008400V	39,36
1/2" BSP	0-600	MFI10008600V	39,36

## Manómetro DN 63 dorsal con glicerina (1/4" BSP)

Pressure gauge DN 63 rear connection with glycerin (1/4" BSP)

Manomètre DN 63 sortie arrière avec glycérine (1/4" BSP)

Manometro DN 63 assiale flangiato a bagno di glicerina (1/4" BSP)



THREAD ROSCA	SCALE (bar) ESCALA (bar)	Part nº Referencia	€
1/4" BSP	0-1	MFI6304001-DB	19,00
1/4" BSP	0-2.5	MFI63042.5-DB	19,00
1/4" BSP	0-4	MFI6304004-DB	19,00
1/4" BSP	0-6	MFI6304006-DB	19,00
1/4" BSP	0-10	MFI6304010-DB	19,00
1/4" BSP	0-12	MFI6304012-DB	19,00
1/4" BSP	0-16	MFI6304016-DB	19,00
1/4" BSP	0-20	MFI6304020-DB	19,00
1/4" BSP	0-25	MFI6304025-DB	19,00
1/4" BSP	0-40	MFI6304040-DB	19,00
1/4" BSP	0-60	MFI6304060-DB	19,00
1/4" BSP	0-100	MFI6304100-DB	19,00
1/4" BSP	0-160	MFI6304160-DB	19,00
1/4" BSP	0-250	MFI6304250-DB	19,00
1/4" BSP	0-315	MFI6304315-DB	19,00
1/4" BSP	0-400	MFI6304400-DB	19,00
1/4" BSP	0-600	MFI6304600-DB	19,00

## Manómetro DN 100 dorsal con glicerina (1/2" BSP)

Pressure gauge DN 100 rear connection with glycerin (1/2" BSP)

Manomètre DN 100 sortie arrière avec glycérine (1/2" BSP)

Manometro DN 100 assiale flangiato a bagno di glicerina (1/2" BSP)



THREAD ROSCA	SCALE (bar) ESCALA (bar)	Part nº Referencia	€
1/2" BSP	0-1	MFI10008001-DB	44,24
1/2" BSP	0-2.5	MFI100082.5-DB	44,24
1/2" BSP	0-4	MFI10008004-DB	44,24
1/2" BSP	0-6	MFI10008006-DB	44,24
1/2" BSP	0-10	MFI10008010-DB	44,24
1/2" BSP	0-16	MFI10008016-DB	44,24
1/2" BSP	0-25	MFI10008025-DB	44,24
1/2" BSP	0-40	MFI10008040-DB	44,24
1/2" BSP	0-60	MFI10008060-DB	44,24
1/2" BSP	0-100	MFI10008100-DB	44,24
1/2" BSP	0-160	MFI10008160-DB	44,24
1/2" BSP	0-250	MFI10008250-DB	44,24
1/2" BSP	0-315	MFI10008315-DB	44,24
1/2" BSP	0-400	MFI10008400-DB	44,24
1/2" BSP	0-600	MFI10008600-DB	44,24

## Manómetro de colores dorsal (1/8" BSPT)

Pressure gauge in colours rear connection (1/8" BSPT)

Manomètre à couleurs sortie arrière avec glycérine (1/8" BSPT)

Manometro a colori assiale flangiato (1/8" BSPT)



SCALE (bar) ESCALA (bar)	Part nº Referencia	€
0-6	MFI CO 06	6,12

## Manómetro digital DN100 vertical (1/2" BSP)

Digital pressure gauge DN100 vertical connection (1/2" BSP)

Manomètre digital DN 100 sortie verticale (1/2" BSP)

Manomètre digital DN100



THREAD ROSCA	SCALE (bar) ESCALA (bar)	Part nº Referencia	€
1/2" BSP	0-1000	MANDIG100V	1.050,00

# Manómetros y vacuómetros

Pressure and vacuum gauges  
Manomètres et vacuomètres  
Manometri e vacuometri

## Vacuómetro DN 63 con glicerina (1/4" BSP)

Vacuum gauge DN 63 with glycerin (1/4" BSP)

Vacuomètre DN 63 avec glicerine (1/4" BSP)

Vacuometro DN 63 a bagno di glicerina (1/4" BSP)



SCALE (bar) ESCALA (bar)	Part nº Referencia	€
-1-0	VAC6304-01I	17,61

## Vacuómetro de colores dorsal (1/8" BSP)

Vacuum gauges in colours rear connection (1/8" BSP)

Vacuomètre à couleurs sortie arrière (1/8" BSP)

Vacuometro a colori assiale flangiato (1/8" BSP)



SCALE (bar) ESCALA (bar)	Part nº Referencia	€
-1-0	MFI VA 01	6,48

## Maletín medida de presión (0 manómetros)

Check cases (0 manometer)

Coffre de mesure (0 manomètre)

Valigetta misurazione di pressione (0 manometro)



SIZE TAMAÑO	SCALE (bar) ESCALA (bar)	Part nº Referencia	€
320x280x119	-	CBOXMEDF	88,20

## Maletín un manómetro digital + accesorios tipo 2

Check case 1 digital manometer + accessories type 2

Coffre 1 manomètre digital + accessoires type 2

Valigetta con uno manometri digitale+ accessori tipo 2



SIZE TAMAÑO	SCALE (bar) ESCALA (bar)	Part nº Referencia	€
320x280x119	0-1000	CBOX0003	1.263,44

## Maletín dos manómetros + accesorios tipo 1

Check case 2 manometers + accessories type 1

Coffre 2 manomètres + accessoires type 1

Valigetta con due manometri+ accessori tipo 1



SIZE TAMAÑO	SCALE (bar) ESCALA (bar)	Part nº Referencia	€
320X280X119	0-160; 0-315	CBOX0001	240,64

## Maletín tres manómetros + accesorios tipo 2

Check case 3 manometers + accessories type 2

Coffre 3 manomètres + accessoires type 2

Valigetta con tre manometri+ accessori tipo 2



SIZE TAMAÑO	SCALE (bar) ESCALA (bar)	Part nº Referencia	€
320x280x119	0-100; 0-250; 0-400	CBOX0002	332,72



CBOX0001



CBOX0002



CBOX0003

### 2 MANÓMETROS 1/4:

0-160  
0-315

### 3 MANÓMETROS 1/4

0-100  
0-250  
0-400

### 1 MANÓMETROS DIG.

0-1000

### ACCESORIOS TIPO 1:

1 MPR 1/4 C/J  
1 MPR 3/8 C/J  
1 MPR 1/4 NPT  
1 MPR A 10X1  
1 MPD 1/4 BSP  
1 CAPUCHÓN ACERO  
1 MPD 90 1/4 BSP  
1 LATIGUILLO MINIMEX TL-TL 16X2 1.5 MTS

### ACCESORIOS TIPO 1:

1 MPR 1/4 C/J  
1 MPR 3/8 C/J  
1 MPR 1/4 NPT  
1 MPR A 10X1  
1 MPD 1/4 BSP  
1 MPD 1/2 BSP  
1 CAPUCHÓN ACERO  
1 MPR PT 1/4 BSP  
1 LATIGUILLO MINIMEX TL-TL 16X2 1 MTS  
1 LATIGUILLO MINIMEX TL-TL 16X2 2 MTS  
1 MPR 7/16 UNF  
1 MPR 9/16 UNF  
1 MPR TLM 122 CM  
1 MPR 3/8 NPT



# Medidores de caudal

Flow tester  
Débitmètres  
Indicatori di flusso

Hoses

Flexible hose fittings

Flow measuring

Processing machine  
for flexible hoses

## Caudalímetro 250 bar - Tipo 3 - 1/2"

Flow tester type 3-1/2"

Débitmètre 250 bar type 3-1/2"

Flussostato 250 bar tipo 3-1/2"



SCALE (l/min) ESCALA (l/min)	Part nº Referencia	€
0-56	WPB3A6HT15	813,56

## Caudalímetro 250 bar - Tipo 5 - 1 1/2"

Flow tester type 5-1 1/2"

Débitmètre 250 bar type 5-1 1/2"

Flussostato 250 bar tipo 5-1 1/2"



SCALE (l/min) ESCALA (l/min)	Part nº Referencia	€
0-550	WPB5A6HY99	4.389,17

## Caudalímetro 250 bar - Tipo 4 - 1"

Flow tester type 4-1"

Débitmètre 250 bar type 4-1"

Flussostato 250 bar tipo 4-1"



SCALE (l/min) ESCALA (l/min)	Part nº Referencia	€
0-150	WPB4A6HV40	1.164,76

## Caudalímetro 400 bar - Tipo 57

Flow tester 400 bar Type 57

Débitmètre 400 bar Type 57

Flussostato 400 bar Tipo 57



SCALE (l/min) ESCALA (l/min)	MAX. PRESSURE (bar) PRESIÓN MAX. (bar)	Part nº Referencia	€
2-30	420	FT5758-01	1.387,21
2-60	420	FT5758-02	1.516,80
4-120	420	FT5758-03	1.646,40

## Caudalímetro 300 bar - Tipo 60

Flow tester 300 bar Tipo 60

Débitmètre 300 bar Tipo 60

Flussostato 300 bar Tipo 60



SCALE (l/min) ESCALA (l/min)	Part nº Referencia	€
10-200	FT6068-01	2.789,15
20-400	FT6068-03	3.484,23

## Caudalímetro 400 bar - con caja

Flow tester 400 bar with box

Débitmètre 400 bar avec boîte

Flussostato 400 bar con cassa



SCALE (l/min) ESCALA (l/min)	MAX. PRESSURE (bar) PRESIÓN MAX. (bar)	Part nº Referencia	€
10-120	420	FT5594-03	3.896,57
10-200	420	FT5594-09	4.002,60

## Foto-tacómetro

Photo-tachometer

Photo-tachymètre

Foto-tachimetro



SIZE TAMAÑO	DESCRIPTION DESCRIPCIÓN	Part nº Referencia	€
195 x 61 x 38.5 mm	PHOTO-TACHOMETER	DT2238	522,75

Hasta fin de existencias. / Until end of stock. / Jusqu'à la fin du stock. / Fino ad esaurimento scorta.

## **Máquinas tratamiento tubo flexible**

*Processing machine for flexible hoses*

Machines pour le montage des flexibles

*Macchine per l'assemblaggio di tubi flessibili*

4

# Máquinas para flexibles. Prensa manuales

*Machines for flexibles. Manual crimping machines*

*Machines pour flexibles. Presses manuelles*

*Macchine per tubi flessibili. Presse manuale*

■ V001040



■ PHM2 12 (3/4" R2) - PHM2 16 (1" R2)



■ PEA 16 (1" R2)



■ PM20

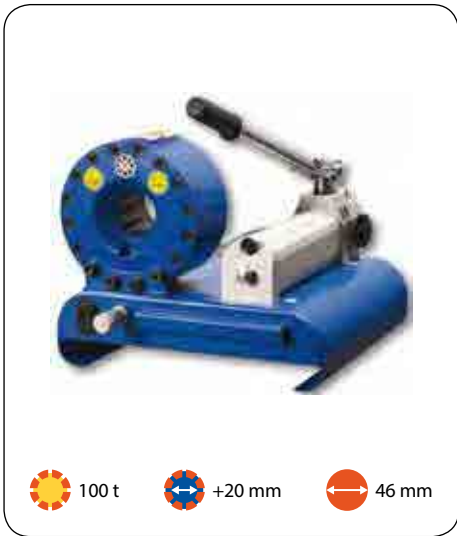

■ S2P



■ PM18



## Máquinas para flexibles. prensas horizontales sobre mesa

Machines for flexibles. Horizontal crimping machines with support

Machines pour flexibles. Presses horizontales avec support

Macchine per tubi flessibili. Presse orizzontale sul tavolo

SE 28 (1" 1/4 4SP)



PE 38 (2" 4 SP)



PE 58 (2" 6 SP)



SPEBDEG



HM 220 (1" 1/4 4SP)



PES 58 (1" 1/4 4SP)

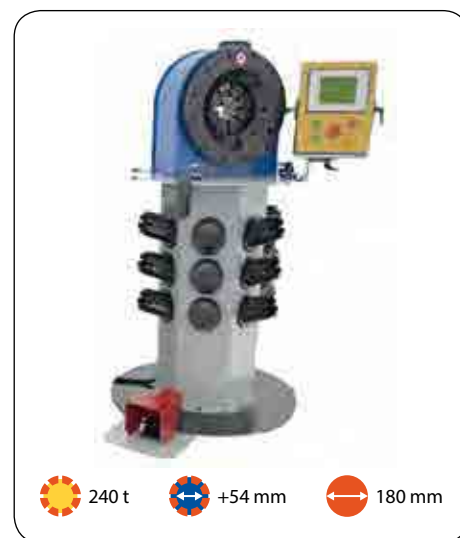

PES 100



## Máquinas para flexibles. prensas horizontales

*Machines for flexibles. Horizontal crimping machines*

*Machines pour flexibles. Presses horizontales*

*Macchine per tubi flessibili. Presse orizzontale*

■ PES 125 (3" 6SP)



■ PESO 320 (6")



■ PE 280 (6")



■ Taller móvil para montaje de latiguillos

*Mobile workshop for hose assembly*

*Atelier mobile pour montage des flexibles*

*Officina mobile per raccordatura tubi*



■ PE 28 12VDC / PE 38 12VDC



■ CHMT 20



■ Bateria

*Battery*

*Batterie*

*Batteria*



## Máquinas para flexibles. Cortadoras

Machines for flexibles. Cutting machines  
Machines pour flexibles. Tronçonneuse  
Macchine per tubi flessibili. Taglierine

■ CHMT-20 (1" 1/4 4SP)



■ CHM4-32D (2" 4SP)



■ CHMT-55 (2" 4SP)



■ TS76 (2" 6SP)



■ MN500SW (hasta 1" 1/2)



■ MN450 (hasta 3/4")



■ UC34



■ CON 125 / CON 320



## Máquinas para flexibles. Otras máquinas

*Machines for flexibles. Other machines*

*Machines pour flexibles. Différentes machines*

*Macchine per tubi flessibili. Altre macchine*

### ■ Banco de pruebas BE 1500 / BE 2500

*Testing bench BE 1500 / BE 2500*

*Banc d'essai BE 1500 / BE 2500*

*Banco de prova BE 1500 / BE 2500*



Opcional  
Optional  
Optionnel  
Opzionale

### ■ Marcadora MMT

*Marking machine*

*Machine de marquage*

*Marcatrice*



### ■ Marcadora MNT 50

*Marking machine*

*Machine de marquage*

*Marcatrice*



### ■ PEP 158



102 t



+28 mm



156 mm

### ■ Banco limpieza RG1

*Cleaning bench*

*Banque de nettoyage*

*Banca per la pulizia*



### ■ Carro de limpieza portátil RG2

*Portable cleaning machine*

*Machine de nettoyage portable*

*Banca per la pulizia portabile*



### ■ S CLEAN 50



### ■ IRT50





# Máquinas para flexibles. Accesorios para prensas

*Machines for flexibles. Accessories for crimping machines*

*Machines pour flexibles. Accessoires pour machines à sertir*

*Macchine per tubi flessibili. Accessori per presse*

## EG



## CME



## Garras especiales

*Special gags*

*Mors spécial*

*Morssetti speciale*



## Computer



## Tope trasero

*Back stop*

*Butée arrière*

*Fermata posteriore*



## EXL



## Portarrollos

*Roll-Holder*

*Porte-Rouleaux*

*Portarotoli*



**Opcional / Optional**  
**Optionnel / Opzionale**



# Peladoras

Skiving machines  
Dénudeuses  
Spellatubi

## ■ PBC-32

**Peladora con mueble hasta 2".**  
**Opción estándar**  
Skiving machine with furniture up to 2", standard option



## ■ PBCM-32

**Peladora con mueble. Opción MS**  
Skiving machine, with furniture MS option



Capacidad pelado exterior / External skiving	2"
Capacidad pelado interior / Internal skiving	2"
R.P.M. / R.P.M.	300
Alimentación neumática / Pneumatic input	Máx. 7 Bar
Potencia motor / Engine power	0,75 KW

### Opcional / Optional / Optionnel / Opzionale

**Mordaza neumática**  
Pneumatic clamp



**Portaherramientas**  
Tool holder



**Mueble portaherramientas**  
Tool holder cabinet



## ■ PB-32

**Peladora sin mueble hasta 2"**  
Skiving machine up to 2"



Capacidad pelado exterior / External skiving	2"
Capacidad pelado interior / Internal skiving	2"
R.P.M. / R.P.M.	300
Potencia motor / Engine power	0,75 KW



**Portaherramientas (opcional)**  
Tool holder (optional)

## ■ Otras máquinas: consultar

Other machines, on request  
Autres machines, sur demande  
Altre macchine, sur richiesta

### ■ PMT2



### ■ PBCMU-32



# Flexibles industriales

*Industrial Flexible Hoses  
& Fittings*

*Flexibles industriels*

*Tubi flessibili e raccordi  
industriali*





<p><b>Mangueras industriales</b> <i>Industrial hoses</i> Tuyaux industriels <i>Tubi industriali</i></p>	1
<p><b>Racores industriales</b> <i>Industrial fittings</i> Raccords industriels <i>Raccordi industriali</i></p>	2
<p><b>Manguera Inox, Racores y Bridas soldables</b> <i>Stainless steel hose, welding fittings and forged flanges</i> Tuyau Inox, raccords et brides à souder <i>Tubi Inox, raccordi e flange a saldare</i></p>	3
<p><b>Baja presión</b> <i>Low pressure</i> Basse pression <i>Tubi a bassa pressione</i></p>	4
<p><b>Aire acondicionado</b> <i>Air conditioning hoses and fittings</i> Climatisation <i>Aria condizionata</i></p>	5

## Mangueras industriales

*Industrial hoses*

Tuyaux industriels

*Tubi industriali*

## Mangueras industriales

*Industrial hoses*

Tuyaux industriels

*Tubi industriali*

1

# Mangueras industriales

Industrial hoses  
Tuyaux industriels  
Tubi industriali

## ■ Mangueras aire-agua / Air-water hoses / Tuyaux air-eau / Tubo acqua-aria

| 106



M8000

MM20

MI0101

MF80

MA1220

MI0102

MI0103

## ■ Mangueras hidrocarburos / Hydrocarbon hoses / Tuyaux pour hydrocarbures / Tubo idrocarburi

| 107



MI0401

MI0404

MI0403

M7000

ML7010

MSB21

## ■ Mangueras soldadura / Welding hoses / Tuyaux pour soudure / Tubi saldatura

| 107

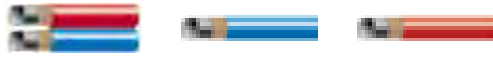

MI0601

MI0602

MI0603

## ■ Mangueras abrasivas / Material handling hoses / Tuyaux abrasifs / Tubo abrasivo

| 109



MI0301

MI0302

MI0303

MI0305

## ■ Mangueras productos químicos / Chemical product hoses / Tuyaux pour produits chimiques / Tubo prodotti chimici

| 109



MI0701

MI0702

## ■ Mangueras alimentarias / Food hoses / Tuyaux alimentaires / Tubo alimentare

| 110



MAS

MI0205

MI0206



# MANGUERAS INDUSTRIALES

## INDUSTRIAL HOSES



Aire/Agua



Polivalente multiservicio



Aspiración Agua



Aspiración Abrasiva



Chorro de Abrasivos

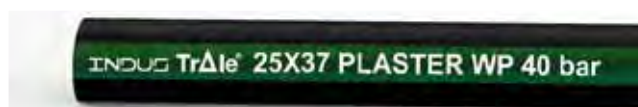

Impulsión de Mortero

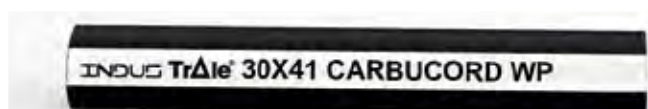

Multipresión Tanques Hidrocarburos



Impulsión de Hidrocarburos



EN 854 3TE



SAE 100 R4



Bebidas Industria Alimentaria



Transporte de Lácteos



Limpieza Industria Alimentaria



Alimentaria Polivalente

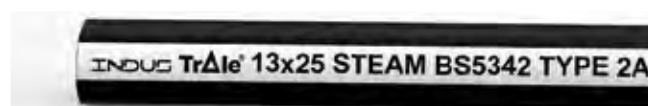

Limpieza Vapor 210°



Bitubo Soldadura Oxígeno-Acetileno



Soldadura Oxígeno



Soldadura Acetileno



Química EPDM



Química UPE

# Mangueras industriales

Industrial hoses  
Tuyaux industriels  
Tubi industriali

## Ariaform aire comprimido y agua-impulsión

Compressed air hose - impulsion

Ariaform refoulement air comprimé et de l'eau



Aria compressa e acqua-impulsi

Ø INNER Ø INT.	Ø outer Ø ext	Part n° Referencia	€
6	14	M80000614	2,41
8	15	M80000817	2,52
10	17	M80001017	3,09
13	21	M80001321	4,77
16	26	M80001626	6,17
19	29	M80001929	7,01

## Polivalente serie continua

Multi-function. Continuous serie

Tuyau polyvalent huiles/eau



Polivalente. Serie continua

Ø INNER Ø INT.	Ø outer Ø ext	Part n° Referencia	€
8	15	MM2008	3,42
10	17	MM2010	4,21
13	21	MM2013	5,39
16	24	MM2016	6,51
19	27	MM2019	8,36
32	44	MM2032	21,88
38	50	MM2038	27,49

## Aspiración agua 10 bar

Water suction hose 10 bar

Tuyau aspiration eau 10 bar



Tubo aspirazione acqua 10 bar

Ø INNER Ø INT.	Ø outer Ø ext	Part n° Referencia	€
25	35	MI01011025	21,83
30	40	MI01011030	26,68
32	42	MI01011032	27,95
35	45	MI01011035	26,45
38	48	MI01011038	27,95
38	48	MI01011040	26,97
51	62	MI01011051	34,07
60	71	MI01011060	41,00
63,5	76	MI01011063.5	43,02
70	82	MI01011070	48,74
76	88	MI01011076	53,59
80	92	MI01011080	56,88
90	102	MI01011090	68,15
102	117	MI01011102	72,82

## Fumigación serie continua

Fumigation hose. Continuous serie

Tuyau fumigation



Fumigazione. Serie continua

Ø INNER Ø INT.	Ø outer Ø ext	Part n° Referencia	€
10	18	MF8010 *	4,83
12,5	21	MF8012	7,85

\*Hasta fin de existencias. / \*Until end of stock. / \*Jusqu'à la fin du stock. / \*Fino ad esaurimento scorta.

## Aire comprimido y agua-impulsión

Compressed air impulsion

Air comprimé impulsion



Aria compressa impulsion

Ø INNER Ø INT.	Ø outer Ø ext	Part n° Referencia	€
25	35	MA122025	14,31
32	45	MA122032	17,56
38	51	MA122040	29,62
51	64	MA122051	36,94
63,5	79,5	MA122063	61,60
75	91	MA122075	68,44

## Vapor 17 bar, limpieza industrial 210°C

Steam hose 17 bar, industrial cleaning, 210°C

Tuyau vapeur 17 bar, nettoyage industriel 210°C



Tubo vapore 17 bar, pulizia industriale, 210°C

Ø INNER Ø INT.	Ø outer Ø ext	Part n° Referencia	€
13	25	MI01021713	*
19	32	MI01021719	*
25	38	MI01021725	34,53
32	46	MI01021732	48,05
38	54	MI01021738	55,67
51	67	MI01021751	80,16
76	96	MI01021776	181,68

## Vapor 7 bar EPDM blanco FDA - limpieza industrial

Steam hose 7 bar, white EPDM FDA Industrial cleaning

Tuyau vapeur 7 bar EPDM blanc FDA Nettoyage industriel



Tubo vapore 7 bar EPDM bianco FDA Pulizia industriale

Ø INNER Ø INT.	Ø outer Ø ext	Part n° Referencia	€
13	23	MI01030713	17,67
16	26	MI01030716	19,58
19	31	MI01030719	24,08
25	37	MI01030725	28,59

# Mangueras industriales

Industrial hoses  
Tuyaux industriels  
Tubi industriali

## Manguera hidrocarburos 10 bar impulsión

Hydrocarbons hose 10 bar discharge

Tuyau pour hydrocarbures 10 bar impulsion



Tubo scarico 10 bar idrocarburi

Ø INNER Ø INT.	Ø outer Ø ext	Part n° Referencia	€
6	12	MI04011006	2,69
8	14	MI04011008	3,31
10	17	MI04011010	4,04
13	20	MI04011013	5,16
16	23	MI04011016	6,34
19	27	MI04011019	8,13
25	35	MI04011025	12,57
32	42	MI04011032	19,75

## Manguera hidrocarburos 20 bar impulsión

Hydrocarbons hose 20 bar discharge

Tuyau pour hydrocarbures 20 bar impulsion



Tubo scarico 20 bar idrocarburi

Ø INNER Ø INT.	Ø outer Ø ext	Part n° Referencia	€
6	12	MI04042006	2,97
8	15	MI04042008	3,93
10	17	MI04042010	4,49
13	20	MI04042013	5,61
16	24	MI04042016	7,35
19	28	MI04042019	9,48
25	35	MI04042025	13,69
32	42	MI04042032	21,77

## Manguera hidrocarburos 10 bar aspiración

Hydrocarbons hose 10 bar intake

Tuyau pour hydrocarbures 10 bar aspiration



Tubo aspirazione 10 bar idrocarburi

Ø INNER Ø INT.	Ø outer Ø ext	Part n° Referencia	€
19	29	MI040310019	21,37
25	35	MI040310025	25,25
32	42	MI040310032	33,49
38	48	MI040310038	38,15
51	61,8	MI040310051	46,96
63	75	MI040310063	60,20
76	89	MI040310076	71,42
101,4	115,4	MI040310102	110,46

## Manguera CarbuCORD 16 bar

CarbuCORD hose 16 bar

Tuyau CarbuCORD 16 bar



Tubo CarbuCORD 16 bar

Ø OUTER Ø EXT.	Ø INNER Ø INT.	Part n° Referencia	€
42	30	M70003041	*
44	32	M70003243	*
54	40	M70004054	*
65	50	M70005064	*

\*Ver precios en pág.12 / \*See prices page 12 / \*Voir prix page 12 / \*Vedere prezzi p.12

## Manguera SAE 100 R4

SAE 100 R4 hose

Tuyau SAE 100 R4



Tubo R4 SAE 100

DN	Ø INNER Ø INT.	Part n° Referencia	€
3/4"	19	ML701019	*
1"	25,4	ML701025	*
1"1/4	31,8	ML701032	*
1"1/2	38,1	ML701038	*
2"	50,8	ML701050	*
2"1/2	63,5	ML701063	*

\*Ver precios en pág.12 / \*See prices page 12 / \*Voir les prix page 12 / \*Vedere prezzi p.12

## Manguera EN 854 R6 / SAE 100 R6

EN 854 R6 / SAE 100 R6 Hose

Tuyau EN 854 R6 / SAE 100 R6



Tubo EN 854 R6 / SAE 100 R6

DN	Ø INNER Ø INT.	Part n° Referencia	€
1/4"	6,3	MSB2104	*
5/16"	8,2	MSB2105	*
3/8"	9,8	MSB2106	*
1/2"	12,9	MSB2108	*
5/8"	16,2	MSB2110	*
3/4"	19,2	MSB2112	*
1"	25	MSB2116	*

\*Ver precios en pág.12 / \*See prices page 12 / \*Voir les prix page 12 / \*Vedere prezzi p.12

# Mangueras industriales

Industrial hoses  
Tuyaux industriels  
Tubi industriali

## Soldadura acetileno

Welding hose acetylene

Tuyau pour soudeuse - acétylène



Tube soldadura-acetilene

Ø INNER Ø INT.	Ø outer Ø ext	Part n° Referencia	€
6,3	13,3	MI06030603	2,97
8	15	MI06030803	3,48
10	17	MI06031003	3,98

## Bitubo (soldadura) oxigeno-acetileno

2 tubes welding hose - oxygene-acetylene

Tuyau pour soudeuse jumelé - oxygène-acétylène



Bitubo soldadura -ossigeno-acetilene

Ø INNER Ø INT.	Ø outer Ø ext	Part n° Referencia	€
6,3-6,3	12,3-12,3	MI0601060612	5,78
8-8	14-14	MI0601080814	6,90
10-10	16-16	MI0601101016	7,80

## Soldadura oxígeno

Welding hose - oxygene

Tuyau pour soudeuse - oxygène



Tube soldadura-ossigeno

Ø INNER Ø INT.	Ø outer Ø ext	Part n° Referencia	€
6,3	13,3	MI06020603	3,03
8	15	MI06020803	3,48
10	17	MI06021003	4,10

# Mangueras industriales

Industrial hoses  
Tuyaux industriels  
Tubi industriali

## Chorro de arena - impulsión 12 bar

Sandblast hose - delivery 12 bar

Tuyau sablage - refoulement 12 bar



Tubo scarico - sabbia 12 bar

Ø INNER Ø INT.	Ø outer Ø ext	Part n° Referencia	€
13	27	MI030112013	17,90
19	33	MI030112019	19,69
25	39	MI030112025	21,94
32	48	MI030112032	29,12
38	54	MI030112038	32,65
42	56	MI030112042	33,94

## Abrasiva 10 bar aspiración

Abrasive hose - suction 10 bar

Tuyau abrasif - aspiration 10 bar



Tubo abrasivo - aspirazione 10 bar

Ø INNER Ø INT.	Ø outer Ø ext	Part n° Referencia	€
51	65	MI030210051	53,88
60	75	MI030210060	62,66
60	75	MI030210063	69,30
76	92	MI030210076	86,63
80	96	MI030210080	89,92
102	118	MI030210102	119,37

## Productos químicos 16 bar EPDM

Chemical products hose 16 bar EPDM

Tuyau produits chimiques 16 bar EPDM



Tubo prodotti chimici 16 bar EPDM

Ø INNER Ø INT.	Ø outer Ø ext	Part n° Referencia	€
19	31	MI070116019	34,17
25	37	MI070116025	39,21
32	44	MI070116032	45,61
38	51	MI070116038	52,17
51	67	MI070116051	78,54
63	79	MI070116063	97,00

## Abrasiva 4 bar impulsión

Abrasive hose - delivery 4 bar

Tuyau abrasif - refoulement 4 bar



Tubo abrasivo - scarico 4 bar

Ø INNER Ø INT.	Ø outer Ø ext	Part n° Referencia	€
90	100	MI030305090	66,87
102	112	MI030305102	74,21
110	120	MI030305110	78,89
127	137	MI030305127	92,17
152	162	MI030305152	106,32
203	213	MI030305203	*

## Abrasiva impulsión 40 bar

Abrasive hose 40 bar

Tuyau abrasif 40 bar



Tubo abrasivo 40 bar

Ø INNER Ø INT.	Ø outer Ø ext	Part n° Referencia	€
25	37	MI030540025	24,80
32	46	MI030540032	31,14
35	49	MI030540035	34,11
38	54	MI030540038	39,78
50	66	MI030540050	52,68
65	83	MI030540065	71,02
76	98	MI030540076	122,41
102	125	MI030540102	172,45

## Productos químicos 16 bar Polietileno/UPE

Chemical products hose 16 bar Polyethylene /UPE

Tuyau produits chimiques 16 bar Polyéthylène / UPE



Tubo prodotti chimici 16 bar Polietilene/UPE

Ø INNER Ø INT.	Ø outer Ø ext	Part n° Referencia	€
19	31	MI070216019	47,18
25	37	MI070216025	54,81
32	44	MI070216032	64,18
38	51	MI070216038	70,80
51	67	MI070216050	90,21
63	79	MI070216063	136,10
75	91	MI070216075	174,30
100	116	MI070216100	229,56

# Mangueras industriales

Industrial hoses  
Tuyaux industriels  
Tubi industriali

Industrial fittings

Stainless steel hose, welding fittings and forged flanges

Low pressure

Air conditioning hoses and fittings

## Manguera alimentaria polivalente FDA 10 bar

*Multi-function food hose FDA 10 bar*

*Tuyau alimentaire polyvalent FDA 10 bar*



*Tubo polivalente alimentari FDA 10 bar*

Ø INNER Ø INT.	Ø outer Ø ext	Part n° Referencia	€
25,4	38	MAS025	37,87
32	45	MAS032	43,76
38	52	MAS038	48,53
50,8	66	MAS051	61,71
63,5	78,5	MAS063	86,96
76,2	93	MAS076	100,42

## Leche anti-extrusión espiral poliamide 6 bar

*Milk hose anti-extrusion polyamide spiral 6 bar*

*Tuyau à lait anti-extrusion spirale polyamide 6 bar*



*Tubo latte anti-estrusione spirale poliammide 6 bar*

Ø INNER Ø INT.	Ø outer Ø ext	Part n° Referencia	€
25	38	MI020510025	43,76
32	45	MI020510032	50,49
38	52	MI020510038	56,66
51	66	MI020510051	71,25
53	78	MI020510063	100,14
76	93	MI020510076	115,85

## Bebidas alcoholicas max. 40% FDA 10 bar

*Alcoholic beverages max. 40% FDA 10 bar*

*Boissons alcoolisées max. 40% bar FDA 10*



*Bevande alcoliche max. 40% bar FDA 10*

Ø INNER Ø INT.	Ø outer Ø ext	Part n° Referencia	€
25	37	MI020610025	38,26
38	50	MI020610038	55,15
51	63	MI020610051	65,69
76	88	MI020610076	101,20

# CARRETES DE METRAJES FIJOS

## CARDBOARD REEL FOR FIXED METERING

NUEVOS  
NEW



PORTACARRETES · CARDBOARD REEL



## Racores industriales

*Industrial fittings*

Raccords industriels

*Raccordi industriali*

### **Acoples GUILLEMIN NF E-29572**

119

*GUILLEMIN NF E-29572 Fittings*

Raccords GUILLEMIN NF E-29572

*Raccordi GUILLEMIN NF E-29572*

### **Acoples TW DIN 28450**

121

*TW DIN 28450 Fittings*

Raccords TW DIN 28450

*Raccordi TW DIN 28450*

### **Acoples STORZ DIN 1430**

122

*STORZ DIN 1430 Fittings*

Raccords STORZ DIN 1430

*Raccordi STORZ DIN 1430*

### **Camlock DIN 2828**

123

*Camlock DIN 2828 Fittings*

Raccords Camlock

*Raccordi Camlock*

### **Acoples BARCELONA UNE 23400**

125

*BARCELONA UNE 23400 Fittings*

Raccords BARCELONA UNE 23400

*Raccordi BARCELONA UNE 23400*

### **Acoples GEKA**

126

*GEKA Fittings*

Raccords GEKA

*Raccordi GEKA*

### **Acoples EXPRESS NF E-29-573**

127

*EXPRESS NF E-29-573 Fittings*

Raccords EXPRESS NF E-29-573

*Raccordi EXPRESS NF E-29-573*



# 2

## **Acoples EA DIN 3489**

*EA DIN 3489 Fittings*  
Raccords EA DIN 3489  
Raccordi EA DIN 3489

128

## **Acoples CHORRO DE ARENA**

*SANDBLAST Fittings*  
Raccords SABLAGE  
Raccordi per SABBIAATURA

129

## **Acoples vapor tipo 'BOSS'**

*Vapor fittings 'BOSS' type*  
Raccords vapeur type 'BOSS'  
Raccordi per vapore tipo BOSS

130

## **Accesorios para rácor industrial**

*Accessories for industrial fittings*  
Accessoires pour raccord industriel  
Accessori per raccordi industriali

131

## Acoples GUILLEMIN NF E-29572

*GUILLEMIN NF E-29572 Fittings*  
 Raccords GUILLEMIN NF E-29572  
 Raccordi GUILLEMIN NF E-29572

### ■ GUILLEMIN aluminio / GUILLEMIN aluminum / GUILLEMIN aluminium / GUILLEMIN aluminum

| 119



ALGU01C



ALGU02C



ALGU01S



ALGU02S



ALGU04C



ALGU03C



ALGU04S



ALGU05C

### ■ Juntas para GUILLEMIN / Seals for GUILLEMIN / Joints pour GUILLEMIN / Giunti per GUILLEMIN

| 120



NBRGU

## Acoples TW DIN 28450

*TW DIN 28450 Fittings*  
 Raccords TW DIN 28450  
 Raccordi TW DIN 28450

### ■ TW Latón / TW brass / TW laiton / TW brass

| 121



BRMK



BRMB

### ■ TW aluminio y latón / TW aluminum and brass / TW aluminium et laiton / TW alluminio e ottone

| 121



ALMB/BRMB



ALVB/BRVB

## Acoples STORZ DIN 1430

*STORZ DIN 1430 Fittings*  
 Raccords STORZ DIN 1430  
 Raccordi STORZ DIN 1430

### ■ STORZ aluminio / STORZ aluminium / STORZ aluminium / STORZ alluminio

| 122



ALST01



ALST03



ALST05



ALST02



ALST04

## Camlock DIN 2828

Camlock DIN 2828 Fittings  
Raccords Camlock  
Raccordi Camlock

■ Camlock aluminio y latón / Camlock Unions aluminum and brass / Raccords Camlock aluminium et laiton / Raccordi Camlock alluminio e ottone

123

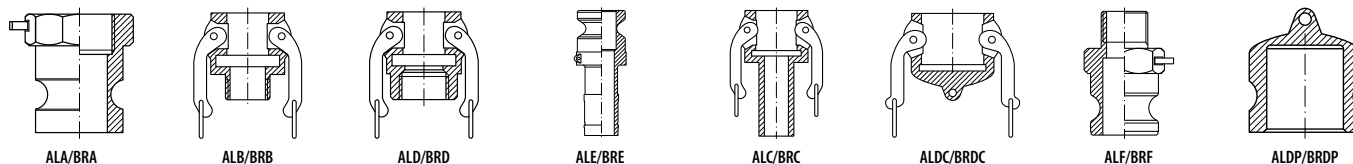

## Acoples BARCELONA UNE 23400

BARCELONA UNE 23400 Fittings  
Raccords BARCELONA UNE 23400  
Raccordi BARCELONA UNE 23400

■ BARCELONA Aluminio / BARCELONA aluminium / BARCELONA aluminium / BARCELONA Alluminio

125



## Acoples GEKA

GEKA Fittings  
Raccords GEKA  
Raccordi GEKA

■ GEKA latón / GEKA brass / GEKA laiton / GEKA ottone

126



## Acoples EXPRESS NF E-29-573

EXPRESS NF E-29-573 Fittings  
Raccords EXPRESS NF E-29-573  
Raccordi EXPRESS NF E-29-573

■ EXPRESS latón / EXPRESS brass / EXPRESS laiton / EXPRESS ottone

127



## Acoples EA DIN 3489

*EA DIN 3489 Fittings*  
 Raccords EA DIN 3489  
 Raccordi EA DIN 3489

■ EA acero / EA steel / EA acier / EA acciaio

| 128



EA01

EA02

EA04

EA05

## Acoples CHORRO DE ARENA

*SANDBLAST Fittings*  
 Raccords SABLAGE  
 Raccordi per SABBIAATURA

■ Chorro de arena aluminio y latón / Sand blast aluminum and brass / Sablage - aluminium et laiton / Sabbatura alluminio e ottone

| 129



ALCH05/BRCH05

ALCH01/BRCH01

ALCH07/BRCH07

## Acoples vapor tipo 'BOSS'

*Vapor fittings 'BOSS' type*  
 Raccords vapeur type 'BOSS'  
 Raccordi per vapore tipo BOSS

■ BOSS acero / BOSS carbon steel / BOSS acier / BOSS acciaio

| 130



B01\_3

# Accesorios para r acor industrial

Accessories for industrial fittings  
 Accessoires pour raccord industriel  
 Accessori per raccordi industriali

## ■ Campana para r acor industrial / Crimping Ferrule for industrial fitting / Jupe pour raccord industriel / Boccola per raccordo industriale

| 131



ALCA

## ■ Abrazadera para r acor industrial / Clamp for industrial fitting / Collier pour raccord industriel / Collare per raccordo industriale

| 131



ALAB01



AB040



AB030



AB050



AB020



# RACORES INDUSTRIALES INDUSTRIAL FITTINGS



CAMLOCK



GUILLEMIN



TW



STORZ



BARCELONA



GEKA



EXPRESS



EA



CHORRO ARENA  
SAND BLAST



VAPOR BOSS  
STEAM BOSS



ABRAZADERAS/CAMPANAS  
CLAMPS/FERRULES



Bajo Consulta / On Request



Tipo / Type  
MORTERO/MORTAR



Tipo / Type  
VICTAULIC



Tipo / Type  
BAUER



Tipo / Type  
PERROT



Tipo / Type  
MILLER



Tipo / Type  
CAMLOCK PP



Wrench  
LLAVES

# Acoples GUILLEMIN NF E-29572

GUILLEMIN NF E-29572 Fittings  
Raccords GUILLEMIN NF E-29572  
Raccordi GUILLEMIN NF E-29572

## GUILLEMIN



Pag. 193



Aplicaciones de presión y aspiración en un rango amplio de industrias.  
Pressure and suction purposes in a wide range of industries.

EN 14420-8 | NF E-29572

Ver ficha técnica | Check technical sheet

● Acero Carbono | Carbon Steel

● Inox | Stainless Steel

● Aluminio | Aluminium

● Latón | Brass

### GUILLEMIN aluminio -rosca hembra BSP con cierre

GUILLEMIN aluminium -BSP Female thread with closure

GUILLEMIN aluminium -Filetage Femelle BSP avec fermeture

GUILLEMIN alluminio -Filetto femmina con chiusura



DN	THREAD ROSCA	Part n° Referencia	€
20	3/4"	ALGU01C020	8,03
25	1"	ALGU01C025	11,10
32	1" 1/4	ALGU01C032	13,00
40	1" 1/2	ALGU01C040	16,25
50	2"	ALGU01C050	23,98
65	2" 1/2	ALGU01C065	29,92
80	3"	ALGU01C080	33,60
100	4"	ALGU01C100	57,58

### GUILLEMIN aluminio -rosca hembra BSP sin cierre

GUILLEMIN aluminium -BSP Female thread without closure

GUILLEMIN aluminium -Filetage Femelle BSP sans fermeture

GUILLEMIN alluminio -Filetto femmina senza chiusura



DN	THREAD ROSCA	Part n° Referencia	€
20	3/4"	ALGU01S020	7,67
25	1"	ALGU01S025	7,67
32	1" 1/4	ALGU01S032	8,34
40	1" 1/2	ALGU01S040	6,44
50	2"	ALGU01S050	8,89
65	2" 1/2	ALGU01S065	10,42
80	3"	ALGU01S080	15,51
100	4"	ALGU01S100	18,82

### GUILLEMIN aluminio -rosca macho BSP con cierre

GUILLEMIN aluminium -BSP Male thread with closure

GUILLEMIN aluminium -Filetage Male BSP avec fermeture

GUILLEMIN alluminio -Filetto maschio con chiusura



DN	THREAD ROSCA	Part n° Referencia	€
20	3/4"	ALGU02C020	8,40
25	1"	ALGU02C025	8,40
32	1" 1/4	ALGU02C032	13,61
40	1" 1/2	ALGU02C040	10,67
50	2"	ALGU02C050	17,35
65	2" 1/2	ALGU02C065	19,25
80	3"	ALGU02C080	33,42
100	4"	ALGU02C100	38,02

### GUILLEMIN aluminio -rosca macho BSP sin cierre

GUILLEMIN aluminium -BSP Male thread without closure

GUILLEMIN aluminium -Filetage Male BSP sans fermeture

GUILLEMIN alluminio -Filetto maschio senza chiusura



DN	THREAD ROSCA	Part n° Referencia	€
20	3/4"	ALGU02S020	7,67
25	1"	ALGU02S025	7,67
32	1" 1/4	ALGU02S032	8,89
40	1" 1/2	ALGU02S040	8,28
50	2"	ALGU02S050	10,91
65	2" 1/2	ALGU02S065	14,59
80	3"	ALGU02S080	21,09
100	4"	ALGU02S100	27,35

# Acoples GUILLEMIN NF E-29572

GUILLEMIN NF E-29572 Fittings  
Raccords GUILLEMIN NF E-29572  
Raccordi GUILLEMIN NF E-29572

## GUILLEMIN aluminio -tapón con cierre

GUILLEMIN aluminium -Plug with closure

GUILLEMIN aluminium -Bouchon avec fermeture

GUILLEMIN alluminio - Tappo con chiusura



DN	Part n° Referencia	€
20	ALGU04C020	9,87
25	ALGU04C025	9,87
32	ALGU04C032	9,87
40	ALGU04C040	11,47
50	ALGU04C050	15,15
65	ALGU04C065	18,09
80	ALGU04C080	25,51
100	ALGU04C100	32,01

## GUILLEMIN aluminio -reductor con cierre

GUILLEMIN aluminium -Reducer with closure

GUILLEMIN aluminium -Réduction avec fermeture

GUILLEMIN alluminio -Riduzione con chiusura



DN	Part n° Referencia	€
40-32	ALGU03C040032	43,04
50-32	ALGU03C050040	37,40
65-50	ALGU03C065050	40,84
80-65	ALGU03C080065	56,29
100-80	ALGU03C100080	82,16

## GUILLEMIN -junta NBR

GUILLEMIN -NBR joint

GUILLEMIN -joint NBR

GUILLEMIN -giunta NBR



DN	Part n° Referencia	€
20	NBRGU020	0,37
25	NBRGU025	0,61
32	NBRGU032	0,67
40	NBRGU040	1,17
50	NBRGU050	1,23
65	NBRGU065	2,21
80	NBRGU080	2,51
100	NBRGU100	5,09

## GUILLEMIN aluminio -tapón sin cierre

GUILLEMIN aluminium -Plug without closure

GUILLEMIN aluminium -Bouchon sans fermeture

GUILLEMIN alluminio -Tappo senza chiusura



DN	Part n° Referencia	€
20	ALGU04S020	*
25	ALGU04S025	*
32	ALGU04S032	11,28
40	ALGU04S040	11,28
50	ALGU04S050	10,42
65	ALGU04S065	16,00
80	ALGU04S080	16,98
100	ALGU04S100	22,50

## GUILLEMIN aluminio -para manguera con cierre

GUILLEMIN aluminium -For hose with closure

GUILLEMIN aluminium -Pour tuyau avec fermeture

GUILLEMIN alluminio - Per tubo con chiusura



DN	THREAD ROSCA	Part n° Referencia	€
40	1" 1/2	ALGU05C040040	15,51
50	2"	ALGU05C050050	20,05
65	2" 1/2	ALGU05C065065	22,14
80	3"	ALGU05C080080	*
100	4"	ALGU05C100100	*



# Acoples TW DIN 28450

TW DIN 28450 Fittings  
Raccords TW DIN 28450  
Raccordi TW DIN 28450

## TW

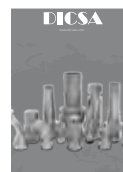

Pag. 195

Para el transporte de líquidos, sólidos y gases ,excepto gas licuado y vapor.  
For the transport of liquids, solids and gases, except liquefied gas and steam.

**DIN 28450 | EN 14420-6**  
Ver ficha técnica | Check technical sheet

● Acero Carbono | Carbon Steel    ● Inox | Stainless Steel    ● Aluminio | Aluminium    ● Latón | Brass

### TW latón -Rosca hembra - acople hembra BSP

*TW brass -Female thread - female coupling*

*TW laiton -Filetage Femelle - accouplement Femelle BSP*

*TW ottone -Filetto femmina- accoppiamento femmina BSP*



DN	Part n.º Referencia	€
2"	<b>BRMK05032</b>	<b>55,86</b>
3"	<b>BRMK08048</b>	<b>109,69</b>
4"	<b>BRMK10064</b>	<b>207,98</b>

### TW latón -Rosca hembra - acople macho BSP

*TW brass -Female thread - male coupling*

*TW laiton - Filetage Femelle - accouplement Male BSP*

*TW ottone -Filetto femmina- accoppiamento maschio BSP*



DN	Part n.º Referencia	€
2"	<b>BRVK05032</b>	<b>23,36</b>
3"	<b>BRVK08048</b>	<b>52,18</b>
4"	<b>BRVK10064</b>	<b>80,08</b>

### TW aluminio y latón -Tapón - acople hembra

*TW aluminum and brass -Plug - Female coupling*

*TW aluminium et laiton -Bouchon - accouplement Femelle*

*TW alluminio e ottone -Tappo- accoppiamento femmina*

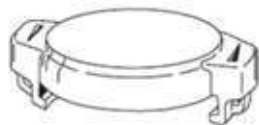

DN	Part n.º Aluminum Referencia Aluminio	€	Part n.º Brass Referencia Latón	€
2"	<b>ALMB050</b>	<b>10,67</b>	<b>BRMB050</b>	<b>17,84</b>
3"	<b>ALMB080</b>	<b>21,40</b>	<b>BRMB080</b>	<b>50,77</b>
4"	<b>ALMB100</b>	<b>44,88</b>	<b>BRMB100</b>	<b>87,25</b>

### TW aluminio y latón -Tapón - acople macho

*TW aluminum and brass -Plug - Male coupling*

*TW aluminium et laiton -Bouchon - accouplement Mâle*

*TW alluminio e ottone -Tappo- accoppiamento maschio*



Part n.º Aluminum Referencia Aluminio	€	Part n.º Brass Referencia Latón	€
<b>ALVB050</b>	<b>7,85</b>	<b>BRVB050</b>	<b>17,60</b>
<b>ALVB080</b>	<b>15,08</b>	<b>BRVB080</b>	<b>47,58</b>
<b>ALVB100</b>	<b>30,41</b>	<b>BRVB100</b>	<b>67,45</b>

# Acoples STORZ DIN 1430

STORZ DIN 1430 Fittings  
Raccords STORZ DIN 1430  
Raccordi STORZ DIN 1430

## STORZ



Para aplicaciones de incendios, agricultura...  
For firefighting, agriculture and delivery use

**DIN 1430**

Ver ficha técnica | Check technical sheet

● Acero Carbono | Carbon Steel

● Inox | Stainless Steel

● Aluminio | Aluminium

● Latón | Brass

### STORZ aluminio- Rosca hembra BSP

STORZ aluminium- Female thread BSP

STORZ aluminium- Filetage femelle BSP

STORZ Alluminio- Filetto femmina BSP



THREAD ROSCA	SIZE TAMAÑO	Part n° Referencia	€
1"	31	ALST01025D16	16,92
1"1/2	51	ALST0103824	17,48
2"	66	ALST01052C32	15,64
2"1/2	81	ALST0106540	34,21
3"	89	ALST01075B48	32,07
4"	133	ALST01110A64	69,35

### STORZ aluminio- Reductor

STORZ aluminium- Reducer

STORZ aluminium- Reducteur

STORZ Alluminio- Riduttore



SIZE TAMAÑO	Part n° Referencia	€
66X31	ALST03052C025D	46,05
89X66	ALST03075B052C	60,40
133X89	ALST03110A075B	121,77

### STORZ aluminio- Para manguera

STORZ aluminium- For hose

STORZ aluminium- Pour tuyau

STORZ Alluminio- Per tubo



DN	SIZE TAMAÑO	Part n° Referencia	€
25	31	ALST05025D	12,26
38	51	ALST05038038	20,11
52	66	ALST05052C052	18,64
65	81	ALST05065065	34,95
75	89	ALST05075B075	33,79
100	133	ALST05110A100	72,72

### STORZ aluminio- Rosca macho BSP

STORZ aluminium- Male thread BSP

STORZ aluminium- Filetage mâle BSP

STORZ Alluminio- Filetto maschio BSP



Ø KA	THREAD ROSCA	Part n° Referencia	€
31	1"	ALST02025D16	19,50
51	1"1/2	ALST0203820	25,38
66	2"	ALST02052C32	17,29
81	2"1/2	ALST0206540	34,21
89	3"	ALST02075B48	33,97
133	4"	ALST02110A64	69,35

### STORZ aluminio- Tapón

STORZ aluminium- Plug

STORZ aluminium- Bouchon

STORZ Alluminio- Tappo



SIZE TAMAÑO	Part n° Referencia	€
31	ALST04025D	17,48
51	ALST04038	16,07
66	ALST04052C	19,62
81	ALST04065	33,54
89	ALST04075B	31,21
133	ALST04110A	71,07

# Camlock DIN 2828

Camlock DIN 2828 Fittings  
Raccords Camlock  
Raccordi Camlock

## CAMLOCK



Pag. 191

Para una amplia gama de aplicaciones como agua, petróleo y productos químicos  
For a wide range of applications such as water, petroleum and chemical liquids

EN 14420-7 | DIN 2828

Ver ficha técnica | Check technical sheet

● Acero Carbono | Carbon Steel

● Inox | Stainless Steel

● Aluminio | Aluminium

● Latón | Brass

### Camlock aluminio y latón macho - rosca hembra BSP Tipo A

Camlock aluminum and brass male - female threaded BSP Type A

Camlock aluminium et laiton - adaptateur mâle - filetage femelle Type A

Adattatore maschio-filettatura femmina Tipo A

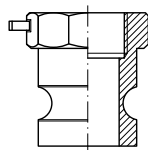

DN	THREAD ROSCA	Part n.º Aluminio Referencia Aluminio	€	Part n.º Brass Referencia Latón	€
12	1/2"	ALA012	2,27	BRA012	6,81
20	3/4"	ALA020	2,45	BRA020	7,17
25	1"	ALA025	3,19	BRA025	8,73
32	1" 1/4	ALA032	4,23	BRA032	12,79
40	1" 1/2	ALA040	4,91	BRA040	18,08
45	2"	ALA050	5,70	BRA050	22,76
65	2" 1/2	ALA065	10,12	BRA065	33,98
80	3"	ALA080	9,69	BRA080	38,97
100	4"	ALA100	17,66	BRA100	71,07

### Camlock aluminio y latón hembra - rosca hembra BSP Tipo D

Camlock aluminum and brass female - female threaded BSP Type D

Camlock aluminium et laiton - adaptateur femelle Type D

Adattatore femmina Tipo D

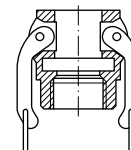

DN	THREAD ROSCA	Part n.º Aluminio Referencia Aluminio	€	Part n.º Brass Referencia Latón	€
12	1/2"	ALD012	5,09	BRD012	14,90
20	3/4"	ALD020	6,07	BRD020	15,59
25	1"	ALD025	7,54	BRD025	19,33
32	1" 1/4	ALD032	11,22	BRD032	29,30
40	1" 1/2	ALD040	11,96	BRD040	31,79
45	2"	ALD050	13,92	BRD050	40,21
65	2" 1/2	ALD065	17,05	BRD065	47,50
80	3"	ALD080	21,71	BRD080	72,37
100	4"	ALD100	31,76	BRD100	109,15

### Camlock aluminio y latón hembra - rosca macho BSP Tipo B

Camlock aluminum and brass female - male threaded BSP Type B

Camlock aluminium et laiton - adaptateur femelle - filetage mâle Type B

Adattatore femmina-filettatura maschio Tipo B

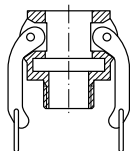

DN	THREAD ROSCA	Part n.º Aluminio Referencia Aluminio	€	Part n.º Brass Referencia Latón	€
12	1/2"	ALB012	5,40	BRB012	14,10
20	3/4"	ALB020	6,01	BRB020	12,47
25	1"	ALB025	7,30	BRB025	17,46
32	1" 1/4	ALB032	10,85	BRB032	26,18
40	1" 1/2	ALB040	11,28	BRB040	30,55
45	2"	ALB050	13,00	BRB050	36,47
65	2" 1/2	ALB065	15,45	BRB065	46,81
80	3"	ALB080	20,85	BRB080	64,95
100	4"	ALB100	29,19	BRB100	90,89

### Camlock aluminio y latón macho - para manguera Tipo E

Camlock aluminum and brass male - serrated hose shank Type E

Camlock aluminium et laiton - coupleur mâle Type E

Adattatore con inserto per Tipo E

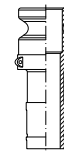

DN	THREAD ROSCA	Part n.º Aluminio Referencia Aluminio	€	Part n.º Brass Referencia Latón	€	
1/2"	12	1/2"	ALE012	2,39	BRE012	8,58
3/4"	20	3/4"	ALE020	2,64	BRE020	10,60
1"	25	1"	ALE025	3,62	BRE025	16,21
1"1/4	32	1" 1/4	ALE032	5,21	BRE032	21,82
1"1/2	40	1" 1/2	ALE040	6,19	BRE040	30,55
2"	45	2"	ALE050	8,34	BRE050	38,97
2"1/2	65	2" 1/2	ALE065	14,78	BRE065	62,28
3"	80	3"	ALE080	16,80	BRE080	90,39
4"	100	4"	ALE100	25,88	BRE100	149,61

# Camlock DIN 2828

Camlock DIN 2828 Fittings  
Raccords Camlock  
Raccordi Camlock

## Camlock aluminio y latón hembra - para manguera Tipo C

Camlock aluminum and brass female - serrated hose shank Type C

Camlock aluminium et laiton - coupleur femelle Type C

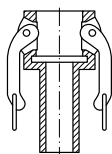

Adattatore con inserto per tubo Tipo C

DN	THREAD ROSCA	Part nº Aluminum Referencia Aluminio	€	Part nº Brass Referencia Latón	€
1/2"	12	ALC012	5,40	BRC012	14,72
3/4"	20	ALC020	6,01	BRC020	15,59
1"	25	ALC025	7,54	BRC025	21,51
1" 1/4	32	ALC032	11,41	BRC032	32,42
1" 1/2	40	ALC040	12,26	BRC040	39,91
2"	45	ALC050	15,27	BRC050	49,87
2" 1/2	65	ALC065	17,90	BRC065	67,14
3"	80	ALC080	24,96	BRC080	90,39
4"	100	ALC100	33,36	BRC100	148,37

## Camlock aluminio y latón hembra - tapón Tipo DC

Camlock aluminum and brass female - plug Type DC

Camlock aluminium et laiton - bouchon femelle Type DC

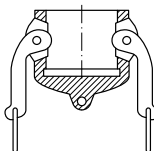

Tappo di protezione Tipo DC

DN	Part nº Aluminum Referencia Aluminio	€	Part nº Brass Referencia Latón	€
12	ALDC012	5,03	BRDC012	12,20
20	ALDC020	5,70	BRDC020	13,72
25	ALDC025	6,87	BRDC025	17,46
32	ALDC032	9,99	BRDC032	27,43
40	ALDC040	10,67	BRDC040	30,55
45	ALDC050	12,45	BRDC050	38,65
65	ALDC065	14,23	BRDC065	48,00
80	ALDC080	18,89	BRDC080	58,60
100	ALDC100	27,16	BRDC100	84,16

## Camlock aluminio y latón macho - rosca macho BSP Tipo F

Camlock aluminum and brass male - male threaded BSP Type F

Camlock aluminium et laiton - adapteur mâle Type F

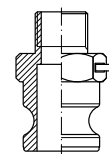

Adattatore maschio Tipo F

DN	THREAD ROSCA	Part nº Aluminum Referencia Aluminio	€	Part nº Brass Referencia Latón	€
12	1/2"	ALF012	2,64	BRF012	8,28
20	3/4"	ALF020	2,64	BRF020	8,73
25	1"	ALF025	3,86	BRF025	11,22
32	1" 1/4	ALF032	5,70	BRF032	17,77
40	1" 1/2	ALF040	6,68	BRF040	21,51
45	2"	ALF050	8,46	BRF050	30,24
65	2" 1/2	ALF065	13,86	BRF065	44,82
80	3"	ALF080	15,33	BRF080	62,58
100	4"	ALF100	25,57	BRF100	94,81

## Camlock aluminio y latón macho - tapón tipo DP

Camlock aluminum and brass male - plug Type DP

Camlock aluminium et laiton - bouchon mâle Type DP

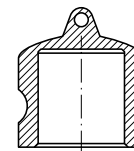

Cappuccio di protezione Tipo DP

DN	Part nº Aluminum Referencia Aluminio	€	Part nº Brass Referencia Latón	€
12	ALDP012	1,47	BRDP012	4,84
20	ALDP020	2,09	BRDP020	5,30
25	ALDP025	2,64	BRDP025	8,10
32	ALDP032	3,92	BRDP032	12,47
40	ALDP040	4,42	BRDP040	15,59
45	ALDP050	6,38	BRDP050	24,94
65	ALDP065	8,83	BRDP065	34,04
80	ALDP080	10,06	BRDP080	51,62
100	ALDP100	16,98	BRDP100	70,88

# Acoples BARCELONA UNE 23400

BARCELONA UNE 23400 Fittings  
Raccords BARCELONA UNE 23400  
Raccordi BARCELONA UNE 23400

## BARCELONA



Para aplicaciones de incendios  
For firefighting use

### UNE 23400

Ver ficha técnica | Check technical sheet



● Acero Carbono | Carbon Steel

● Inox | Stainless Steel

● Aluminio | Aluminium

● Latón | Brass

#### BARCELONA aluminio -Rosca hembra BSP

BARCELONA aluminium- Female thread BSP

BARCELONA aluminium- Filetage femelle BSP

BARCELONA Alluminio- Filetto femmina BSP



THREAD ROSCA	SIZE TAMAÑO	Part nº Referencia	€
1"	25	ALBA0102516	10,98
1" 1/2	45	ALBA0104524	17,17
2" 1/2	70	ALBA0107040	33,30

#### BARCELONA aluminio -Reductor

BARCELONA aluminium- Reducer

BARCELONA aluminium- Reducteur

BARCELONA Alluminio- Riduttore



SIZE TAMAÑO	Part nº Referencia	€
70-45	ALBA03070045	*
45-25	ALBA03045025	*

#### BARCELONA aluminio -Para manguera

BARCELONA aluminium- For hose

BARCELONA aluminium- Pour tuyau

BARCELONA Alluminio- Per tubo



DN	SIZE TAMAÑO	Part nº Referencia	€
25	25	ALBA05025025	17,35
45	45	ALBA05045045	28,57
70	70	ALBA05070070	49,05

#### BARCELONA aluminio -Rosca macho BSP

BARCELONA aluminium- Male thread BSP

BARCELONA aluminium- Filetage mâle BSP

BARCELONA Alluminio- Filetto maschio BSP



THREAD ROSCA	SIZE TAMAÑO	Part nº Referencia	€
1"	25	ALBA0202516	10,98
1" 1/2	45	ALBA0204524	19,13
2" 1/2	70	ALBA0207040	39,55

#### BARCELONA aluminio -Tapón

BARCELONA aluminium- Plug

BARCELONA aluminium- Bouchon

BARCELONA Alluminio- Tappo



SIZE TAMAÑO	Part nº Referencia	€
25	ALBA04025	*
45	ALBA04045	*
70	ALBA04070	*

# Acoples GEKA

GEKA Fittings  
Raccords GEKA  
Raccordi GEKA

## GEKA



Para aplicaciones de agricultura, jardinería, construcción y servicios públicos  
For agricultural, gardening, construction and public service applications

Ver ficha técnica | Check technical sheet

● Acero Carbono | Carbon Steel    ● Inox | Stainless Steel    ● Aluminio | Aluminium    ● Latón | Brass

### GEKA latón -Rosca hembra BSP

GEKA brass- Female thread BSP

GEKA laiton- Filetage femelle BSP

GEKA ottone - Filetto femmina BSP



THREAD ROSCA	Part nº Referencia	€
3/8"	BRGE0106	4,35
1/2"	BRGE0108	4,48
3/4"	BRGE0112	4,48
1"	BRGE0116	4,48
1"1/4	BRGE0120	6,44
1"1/2	BRGE0124	7,60

### GEKA latón -Rosca macho BSP

GEKA brass- Male thread BSP

GEKA laiton- Filetage mâle BSP

GEKA ottone - Filetto maschio BSP



THREAD ROSCA	Part nº Referencia	€
3/8"	BRGE0206	4,35
1/2"	BRGE0208	4,35
3/4"	BRGE0212	4,48
1"	BRGE0216	4,48
1"1/4	BRGE0220	5,95
1"1/2	BRGE0224	7,36

### GEKA latón -Tapón

GEKA brass- Plug

GEKA laiton- Bouchon

GEKA ottone - Tappo



Part nº Referencia	€
BRGE04	4,35

### GEKA latón -Para manguera

GEKA brass- For hose

GEKA laiton- Pour tuyau

GEKA ottone - Per tubo



DN	Part nº Referencia	€
10	BRGE0510	4,29
13	BRGE0513	4,29
16	BRGE0516	4,60
19	BRGE0519	4,91
25	BRGE0525	6,32
32	BRGE0532	7,48
38	BRGE0538	9,63



# Acoples EXPRESS NF E-29-573

EXPRESS NF E-29-573 Fittings  
Raccords EXPRESS NF E-29-573  
Raccordi EXPRESS NF E-29-573

## EXPRESS



Para aplicaciones de agua y aire comprimido

For water and compressed air applications

NF E-29573

Ver ficha técnica | Check technical sheet



● Acero Carbono | Carbon Steel

● Inox | Stainless Steel

● Aluminio | Aluminium

● Latón | Brass

### EXPRESS latón- Rosca hembra BSP

EXPRESS brass- Female thread BSP

EXPRESS laiton- Filetage femelle BSP

EXPRESS ottone - Filetto femmina BSP



THREAD ROSCA	Part nº Referencia	€
1/4"	BREX0104	5,15
3/8"	BREX0106	5,15
1/2"	BREX0108	5,40
3/4"	BREX0112	5,89
1"	BREX0116	5,89
1" 1/4	BREX0120	8,46

### EXPRESS latón- Rosca macho BSP

EXPRESS brass- Male thread BSP

EXPRESS laiton- Filetage mâle BSP

EXPRESS ottone - Filetto maschio BSP



THREAD ROSCA	Part nº Referencia	€
1/4"	BREX0204	5,15
3/8"	BREX0206	5,70
1/2"	BREX0208	5,21
3/4"	BREX0212	5,52
1"	BREX0216	6,32
1" 1/4	BREX0220	9,75

### EXPRESS latón- Tapón

EXPRESS brass- Plug

EXPRESS laiton- Bouchon

EXPRESS ottone - Tappo



Part nº Referencia	€
BREX04	5,27

### EXPRESS latón- Para manguera

EXPRESS brass- For hose

EXPRESS laiton- Pour tuyau

EXPRESS ottone - Per tubo



DN	Part nº Referencia	€
8	BREX0508	5,27
10	BREX0510	4,66
13	BREX0513	4,91
16	BREX0516	5,03
19	BREX0519	6,13
25	BREX0525	6,93
32	BREX0532	7,91

# Acoples EA DIN 3489

EA DIN 3489 Fittings  
Raccords EA DIN 3489  
Raccordi EA DIN 3489

## Air European (EA)



Para aplicaciones de agua y aire comprimido

For water and compressed air applications

**DIN 3489**

Ver ficha técnica | Check technical sheet

● Acero Carbono | Carbon Steel

● Inox | Stainless Steel

● Aluminio | Aluminium

● Latón | Brass



### EA acero- Rosca hembra BSP

EA steel- Female thread BSP

EA acier- Filetage femelle BSP

EA acciaio - Filetto femmina BSP



THREAD ROSCA	Part nº Referencia	€
1/2"	EA0108	3,62
3/4"	EA0112	4,05
1"	EA0116	4,35

### EA acero- Rosca macho BSP

EA steel- Male thread BSP

EA acier- Filetage mâle BSP

EA acciaio - Filetto maschio BSP



THREAD ROSCA	Part nº Referencia	€
1/2"	EA0208	4,23
3/4"	EA0212	4,35
1"	EA0216	5,15

### EA acero- Tapón

EA steel- Plug

EA acier- Bouchon

EA acciaio - Tappo



Part nº Referencia	€
EA04	4,17

### EA acero- Para manguera c/collar

EA steel- For hose

EA acier- Pour tuyau avec collier

EA acciaio - Per tubo



DN	Part nº Referencia	€
13	EA0513	4,35
16	EA0516	4,60
19	EA0519	4,60
25	EA0525	5,40



# Acoples CHORRO DE ARENA

SANDBLAST Fittings  
Raccords SABLAGE  
Raccordi per SABBIATURA

## CHORRO DE ARENA

SAND BLAST



Para aplicaciones de chorro de arena y gunitados  
For sandblasting and build-up applications

Ver ficha técnica | Check technical sheet

● Acero Carbono | Carbon Steel

● Inox | Stainless Steel

● Aluminio | Aluminium

● Latón | Brass

### Chorro de arena aluminio y latón acople - para manguera

Sand blast aluminum and brass -for hose

Sablage aluminium et laiton -pour le tuyau

Raccordo Sabbatura alluminio e ottone -per tubo



DN	Part nº Aluminum Referencia Aluminio	€	Part nº Brass Referencia Latón	€
19	ALCH0519	10,73	BRCH0519	44,58
25	ALCH0525	10,73	BRCH0525	47,95
32	ALCH0532	15,94	BRCH0532	72,97
38	ALCH0538	22,75	BRCH0538	113,43

### Chorro de arena aluminio y latón acople - rosca hembra BSP

Sand blast aluminum and brass -Female thread  
BSP

Sablage aluminium et laiton -Filetage femelle  
BSP

Raccordo Sabbatura alluminio e ottone -Filetto  
femmina BSP



THREAD ROSCA	Part nº Aluminum Referencia Aluminio	€	Part nº Brass Referencia Latón	€
1" 1/4	ALCH0120	11,10	BRCH0120	49,11
1" 1/2	ALCH0124	11,10	BRCH0124	49,11

### Chorro de arena aluminio y latón para manguera - rosca hembra BSP

Sand blast aluminum and brass -for hose-Female  
thread BSP

Sablage aluminium et laiton -Filetage femelle  
BSP pour tuyau

Raccordo Sabbatura alluminio e ottone -per  
tubo- Filetto femmina BSP



DN	THREAD ROSCA	Part nº Aluminum Referencia Aluminio	€	Part nº Brass Referencia Latón	€
19	3/4"	ALCH071219	6,13	BRCH071219	37,22
25	1"	ALCH071625	9,20	BRCH071625	52,92
32	1" 1/4	ALCH072032	12,63	BRCH072032	69,96
38	1" 1/2	ALCH072438	17,60	BRCH072438	94,79



## Acoples vapor tipo 'BOSS'

Vapor fittings 'BOSS' type  
Raccords vapeur type 'BOSS'  
Raccordi per vapore tipo BOSS

# VAPOR BOSS

STEAM BOSS



Adecuado para las conexiones de manguera de vapor, y también ampliamente utilizado para aire comprimido, agua, gas petróleo licuado y fluidos químicos, etc.

*Suitable for steam hose connections, and widely used for compressed air, water, liquid petroleum gas, chemical fluids, etc.*

Ver ficha técnica | Check technical sheet

● Acero Carbono | Carbon Steel    ● Inox | Stainless Steel    ● Aluminio | Aluminium    ● Latón | Brass



### BOSS acero kit NPT

*BOSS carbon steel kit NPT*

*BOSS acier kit NPT*

*BOSS acciaio kit NPT*



DN	Part nº Referencia	€
1/2"	<b>BO0813</b>	<b>24,77</b>
3/4"	<b>BO1219</b>	<b>30,84</b>
1"	<b>BO1625</b>	<b>31,46</b>
1"1/4	<b>BO2032</b>	<b>55,74</b>
1"1/2	<b>BO2438</b>	<b>57,27</b>
2"	<b>BO3251</b>	<b>76,95</b>

# Accesorios para r acor industrial

Accessories for industrial fittings  
Accessoires pour raccord industriel  
Accessori per raccordi industriali

Industrial hoses

Industrial fittings

Stainless steel hose, welding fittings and forged flanges

Low pressure

Air conditioning hoses and fittings

## Campana aluminio para racor industrial - cierre 45 

*Crimping Ferrule 45  closure*

*Jupe pour raccord industriel -fermeture 45 *

*Boccola per raccordo industriale-chiusura 45 *



DN	Part n� Referencia	�
25	ALCA025	3,80
32	ALCA032	4,23
40	ALCA040	6,75
50	ALCA050	10,36
50	ALCA05001	12,82
65	ALCA065	12,82
80	ALCA080	10,91
100	ALCA100	17,60

## Abrazadera EN 14420-3 aluminio

*Clamp EN14420-3 aluminium*

*Collier EN 14420-3 aluminium*

*Collare EN 14420 alluminio*



� INNER � INT.	Part n� Referencia	�
34-37 mm	ALAB01034037	12,63
36-39 mm	ALAB01036039	13,06
41-44 mm	ALAB01041044	16,80
47-51 mm	ALAB01047051	17,11
62-64 mm	ALAB01060064	27,04
63-67 mm	ALAB01063067	18,40
74-77 mm	ALAB01074077	37,89
84-87 mm	ALAB01084087	41,88
87-90 mm	ALAB01087090	42,31
89-94 mm	ALAB01089094	30,90
114-119 mm	ALAB01114119	77,32

## Abrazadera DIN 20039 A Acero

*Clamp DIN 20039 A steel*

*Collier DIN 20039 A acier*

*Collare DIN 20039 A acciaio*



� INNER � INT.	Part n� Referencia	�
22-29 mm	AB04022029	4,91
28-34 mm	AB04028034	5,15
32-40 mm	AB04032040	5,64

## Accesorios para r acor industrial

Accessories for industrial fittings  
Accessoires pour raccord industriel  
Accessori per raccordi industriali

### Abrazadera Express Acero

Clamp Express steel

Collier Express acier

Collare Express acciaio



� INNER � INT.	Part n� Referencia	�
19-21 mm	AB031921	1,17
22-24 mm	AB032224	1,23
25-27 mm	AB032527	1,29
28-30 mm	AB032830	1,53
31-33 mm	AB033133	1,90
34-36 mm	AB033436	3,25
37-39 mm	AB033739	4,11

### Abrazadera tipo Boss acero

Clamp type Boss steel

Collier type Boss acier

Collare tipo BOSS acciaio



� INNER � INT.	Part n� Referencia	�
24-27 mm	AB05024027	3,92
30-33 mm	AB05030033	7,36
38-43 mm	AB05038043	15,02
43-49 mm	AB05043049	16,43
54-60 mm	AB05054060	21,83
63-71 mm	AB05063071	27,04

### Abrazadera alta presi n W1 acero

Clamp high pressure W1

Collier haute pression W1 acier

Collare alta pressione W1



� INNER � INT.	Part n� Referencia	�
17-19 mm	AB02017019	1,29
20-22 mm	AB02020022	1,29
23-25 mm	AB02023025	1,47
26-28 mm	AB02026028	1,47
29-31 mm	AB02029031	1,66
32-35 mm	AB02032035	1,66
36-39 mm	AB02036039	1,90
40-43 mm	AB02040043	1,72
44-47 mm	AB02044047	2,02
48-51 mm	AB02048051	2,02
52-55 mm	AB02052055	2,21
56-59 mm	AB02056059	2,21
60-63 mm	AB02060063	2,27
64-67 mm	AB02064067	2,33
68-73 mm	AB02068073	3,07
74-79 mm	AB02074079	3,19
80-85 mm	AB02080085	3,25
86-91 mm	AB02086091	3,43
92-97 mm	AB02092097	3,50
98-103 mm	AB02098103	3,62
104-112 mm	AB02104112	3,74
113-121 mm	AB02113121	3,80
122-130 mm	AB02122130	3,92
131-139 mm	AB02131139	5,27
140-148 mm	AB02140148	5,27
149-161 mm	AB02149161	5,64
162-174 mm	AB02162174	5,64
175-187 mm	AB02175187	5,95
188-200 mm	AB02188200	6,38

# ACERO INOXIDABLE STAINLESS STEEL



CONEXIONES PARA FLEXIBLES  
TUBO RÍGIDO  
RACORES DIN 2353  
RACORES JIC 37°  
BRIDAS SAE  
RACORES SOLDABLES  
ADAPTADORES BSP  
ADAPTADORES NPT  
ADAPTADORES O´RING BOSS  
ADAPTADORES ORFS  
RACORES INDUSTRIALES  
ENCHUFES RÁPIDOS  
LLAVES DE PASO  
COMPONENTES HIDRÁULICOS



CRIMP FITTINGS FOR HOSES  
RIGID PIPE  
DIN 2353 PIPE FITTINGS  
FLARE FITTINGS JIC 37°  
SAE FLANGES  
WELDING FITTINGS  
BSP ADAPTORS  
NPT ADAPTORS  
O´RING BOSS ADAPTORS  
ORFS ADAPTORS  
INDUSTRIAL FITTINGS  
QUICK COUPLINGS  
BALL VALVES  
HYDRAULIC COMPONENTS

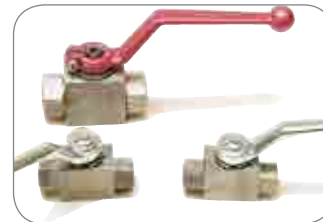

## **Manguera Inox, Racores y Bridas soldables**

*Stainless steel hose, welding fittings and forged flanges*

Tuyau Inox, raccords et brides à souder

*Tubi Inox, raccordi e flange a saldare*

## **Manguera Inox, Racores y Bridas soldables**

*Stainless steel hose, welding fittings and forged flanges*

Tuyau Inox, raccords et brides à souder

*Tubi Inox, raccordi e flange a saldare*

3

# Manguera Inox, Racores y Bridas soldables

*Stainless steel hose, welding fittings and forged flanges*

*Tuyau Inox, raccords et brides à souder*

*Tubi Inox, raccordi e flange a saldare*

■ **Mangueras Inox corrugado / Convoluted stainless steel hoses / Tuyaux inox onduleux / Tubi Inox corrugato**

| 138



M93211

M93212

M93161

M304

■ **Racores soldables BSP / BSP Welding fittings / Raccords à souder BSP / Raccordi a saldare BSP**

| 139

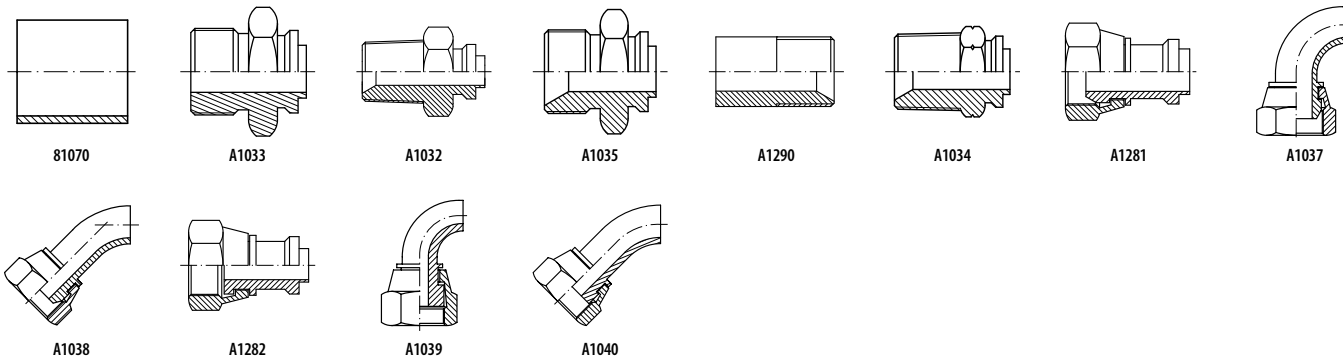

81070

A1033

A1032

A1035

A1290

A1034

A1281

A1037

A1038

A1282

A1039

A1040

■ **Racores soldables JIC 37° / JIC 37° Welding fittings / Raccords à souder JIC 37° / Raccordi a saldare JIC 37°**

| 141

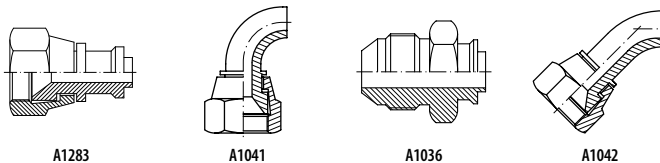

A1283

A1041

A1036

A1042

■ **Racor soldable métrica / Metric Welding fittings / Raccords à souder métriques / Raccordi a saldare metrici**

| 142

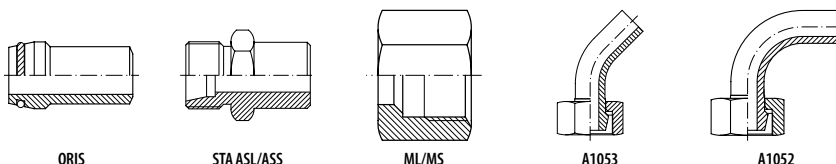

ORIS

STA ASL/ASS

ML/MS

A1053

A1052

■ **Cono y tuerca / Nipple and nut / Collet et écrou / Ogiva y dado**

| 144

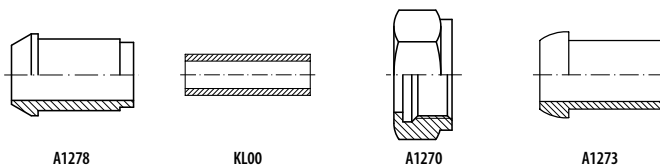

A1278

KL00

A1270

A1273

■ **Racores para soldar >2" / Welding fittings >2" / Raccords à souder >2" / Raccordi a saldare >2"**

| 144

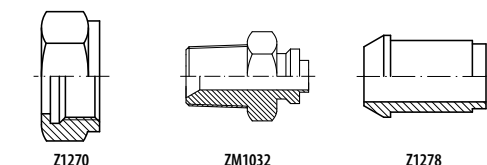

Z1270

ZM1032

Z1278

■ **Bridas fijas para soldar / Fixed Forged flanges / Brides DIN à souder fixes / Flangia a saldare**

| 145

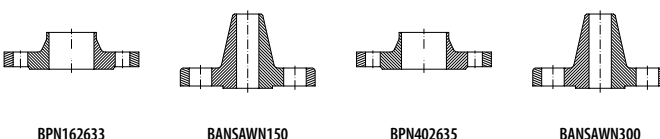

BPN162633

BANSAWN150

BPN402635

BANSAWN300



# Manguera Inox, Racores y Bridas soldables

*Stainless steel hose, welding fittings and forged flanges*

*Tuyau Inox, raccords et brides à souder*

*Tubi Inox, raccordi e flange a saldare*

## ■ Conjunto brida DIN 2642 / DIN 2642 swivel flanges set / Ensemble brides tournantes DIN 2642 / Flangia girevole DIN 2642

| 146

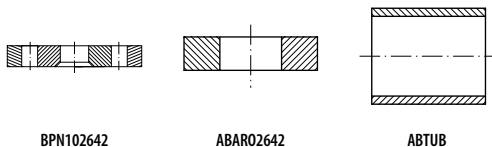

## ■ Conjunto brida DIN 2656 / DIN 2656 swivel flanges set / Ensemble brides tournantes DIN 2656 / Flangia girevole DIN 2656

| 147

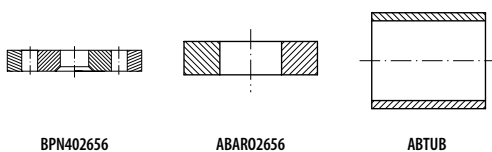

## ■ Conjunto brida ANSI-ASA / ANSI-ASA swivel flanges set / Ensemble brides ANSI-ASA / Flangia girevole ANSI-ASA

| 149

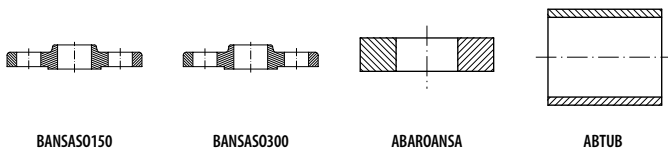

# Manguera Inox, Racores y Bridas soldables

Stainless steel hose, welding fittings and forged flanges

Tuyau Inox, raccords et brides à souder

Tubi Inox, raccordi e flange a saldare

## Inox corrugado AISI 321 con una malla AISI 304

Convuluted S.S. AISI 321 hose with one braid S.S. AISI 304

Inox onduleux AISI 321 avec une tresse inox AISI 304



Tubo in Inox corrugato 321 con una maglia AISI 304

DN	Ø INNER Ø INT.	Part nº Referencia	€
1/4"	6,2	M93211006	7,41
3/8"	10,3	M93211010	9,36
1/2"	12,2	M93211012	9,75
5/8"	16,2	M93211016	15,60
3/4"	20,2	M93211020	20,28
1"	25,4	M93211025	25,35
1" 1/4	34,3	M93211032	30,89
1" 1/2	40,1	M93211040	39,90
2"	50,3	M93211050	56,20
2" 1/2	65,6	M93211065	78,94
3"	80,3	M93211080	87,37
4"	100,8	M93211100	115,45

## Inox corrugado AISI 321 con dos mallas AISI 304

Convuluted S.S. AISI 321 hose with two braids S.S. AISI 304

Inox onduleux AISI 321 avec deux tresses inox AISI 304



Tubo in Inox corrugato 321 con due maglie AISI 304

DN	Ø INNER Ø INT.	Part nº Referencia	€
1/4"	6,2	M93212006	11,15
3/8"	10,3	M93212010	12,87
1/2"	12,2	M93212012	14,16
3/4"	20,2	M93212020	29,17
1"	25,4	M93212025	36,90
1" 1/4	34,3	M93212032	43,76
1" 1/2	40,1	M93212040	57,92
2"	50,3	M93212050	81,94
2" 1/2	65,6	M93212065	111,12
3"	80,3	M93212080	127,85
4"	100,8	M93212100	166,46

## Inox corrugado AISI 316 con una malla AISI 316

Convuluted S.S. AISI 316 hose with one braid S.S. AISI 316

Inox onduleux AISI 316 avec une tresse inox AISI 316



Tubo in Inox corrugato 316 con una maglia AISI 316

DN	Ø INNER Ø INT.	Part nº Referencia	€
1/4"	6,2	M93161006	11,58
3/8"	10,3	M93161010	13,73
1/2"	12,2	M93161012	16,30
3/4"	20,2	M93161020	30,89
1"	25,4	M93161025	36,47
1" 1/4	34,3	M93161032	55,77
1" 1/2	40,1	M93161040	64,35
2"	50,3	M93161050	85,81
2" 1/2	65,6	M93161065	115,84
3"	80,3	M93161080	134,71
4"	100,8	M93161100	177,19

## Malla inox 304

AISI 304 braid

Tresse inox 304



Maglia di acciaio Inox 304

Ø INNER Ø INT.	Part nº Referencia	€
9,6	M304009.6	3,51
12,3	M304012.3	3,90
14,3	M304014.3	4,29
16,7	M304016.7	4,68
21,6	M304021.6	8,97
26,8	M304026.8	10,14
32,2	M304032.2	12,09
41,1	M304041.1	17,94
49,8	M304049.8	21,84
80,8	M304080.8	39,78
60,3	M304060.3	28,08

Consultar | On request | Sur demande | Su richiesta



Cortadora de tubo corrugado DN50 (máx. 2")  
Cutter for metal corrugated hoses DN50 (up to 2")



Mesa de Soldadura  
Welding table

# Manguera Inox, Racores y Bridas soldables

Stainless steel hose, welding fittings and forged flanges

Tuyau Inox, raccords et brides à souder

Tubi Inox, raccordi e flange a saldare

## Casquillo soldable Inox corrugado

Convuluted SS welding ferrule

Jupe à souder Inox convoluté

Boccola a saldare per inox corrugato

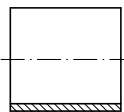

DN	Ø INNER Ø INT.	Part n° Referencia	€
1/4"	14	810700400	1,62
1/4"	12	810700401	1,62
3/8"	19	810700600	2,52
3/8"	17	810700601	1,85
1/2"	22	810700800	2,37
1/2"	19	810700801	2,37
5/8"	25	810701000	2,75
3/4"	30	810701200	2,92
3/4"	32	810701201	3,20
1"	35	810701500	5,40
1"	38	810701600	5,40
1"1/4"	47,8	810702000	6,15
1"1/4"	44,3	810702001	6,15
1"1/2"	56,1	810702400	7,19
2"	66	810703201	12,60
2"1/2"	84,8	810704000	21,63
2"1/2"	95,6	810704001	21,63
3"	100	810704801	26,26
4"	125	810706400	34,13

Acero inoxidable AISI 316 / Stainless steel AISI 316 / Acier inoxydable AISI 316 / Acciaio inossidabile AISI 316

## Macho fijo BSP asiento plano - soldable con guía

Fixed male BSP flat seat weldable with guide

Mâle fixe BSP fond plat à souder avec guide

Maschio BSP faccia piana, a saldare con guida

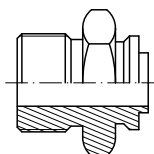

DN	THREAD ROSCA	Part n° Referencia	€
1/4"	1/4" BSP	A103304	1,62
3/8"	3/8" BSP	A103306	1,96
1/2"	1/2" BSP	A103308	2,57
3/4"	3/4" BSP	A103312	3,73
1"	1" BSP	A103316	6,08
1"1/4"	1"1/4 BSP	A103320	12,26
1"1/2"	1"1/2 BSP	A103324	15,95
2"	2" BSP	A103332	24,79

## Macho cónico BSPT con guía

Welding adaptor BSPT with guide

Mamelon hexagonal BSPT conique à souder (bw) + guide

Maschio conico BSPT con guida

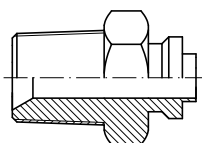

DN	THREAD ROSCA	Part n° Referencia	€
1/4"	1/4" BSPT	A103204	2,10
3/8"	3/8" BSPT	A103206	2,37
1/2"	1/2" BSPT	A103208	3,19
3/4"	3/4" BSPT	A103212	3,61
1"	1" BSPT	A103216	5,93
1"1/4"	1"1/4 BSPT	A103220	15,05
1"1/2"	1"1/2 BSPT	A103224	14,87
2"	2" BSPT	A103232	20,71
2"1/2"	2"1/2 BSPT	A103240	62,39

## Macho BSP cono 60° con guía

Welding adaptor BSP 60° with guide

Mamelon hexagonal BSP à souder (bw) + guide

Maschio BSP a saldare sede 60° con guida

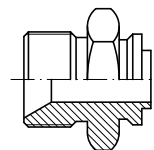

DN	THREAD ROSCA	Part n° Referencia	€
1/4"	1/4" BSP	A103504	1,09
3/8"	3/8" BSP	A103506	1,28
1/2"	1/2" BSP	A103508	1,82
3/4"	3/4" BSP	A103512	3,01
1"	1" BSP	A103516	4,38
1"1/4"	1"1/4 BSP	A103520	10,03
1"1/2"	1"1/2 BSP	A103524	14,05
2"	2" BSP	A103532	29,27

## Empalme liso soldable rosca BSP (60°)

Welding union BSP male (60°)

Embout mâle lisse à souder gaz cyl BSP (60°)

Mezzo nipples tondo a saldare BSP 60°

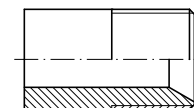

THREAD ROSCA	Part n° Referencia	€
1/8" BSP	A129002	1,20
1/4" BSP	A129004	0,70
3/8" BSP	A129006	0,84
1/2" BSP	A129008	1,06
3/4" BSP	A129012	1,85
1" BSP	A129016	4,49
1"1/4 BSP	A129020	14,31
1"1/2 BSP	A129024	15,14
2" BSP	A129032	14,48

## Macho fijo NPT - soldable con guía

Fixed male NPT weldable with guide

Mâle fixe NPT à souder avec guide

Maschio NPT, a saldare con guida

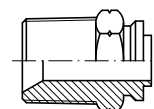

DN	THREAD ROSCA	Part n° Referencia	€
1/4"	1/4" NPT	A103404	1,33
3/8"	3/8" NPT	A103406	1,95
1/2"	1/2" NPT	A103408	2,21
3/4"	3/4" NPT	A103412	3,53
1"	1" NPT	A103416	5,89
1" 1/4"	1" 1/4 NPT	A103420	11,44
1" 1/2"	1" 1/2 NPT	A103424	13,30
2"	2" NPT	A103432	27,96

# Manguera Inox, Racores y Bridas soldables

Stainless steel hose, welding fittings and forged flanges

Tuyau Inox, raccords et brides à souder

Tubi Inox, raccordi e flange a saldare

## Hembras giratorias prensada BSP 60° - soldable con guía

*Crimped BSP swivel female 60° weldable with guide*

Embout à sertir femelle tournante BSP 60° à souder avec guide

*Femmina diritta girevole BSP, a saldare con guida*

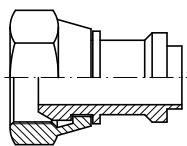

DN	THREAD ROSCA	Part n° Referencia	€
1/4"	1/4" BSP	A128104	1,40
3/8"	3/8" BSP	A128106	1,76
1/2"	1/2" BSP	A128108	2,50
3/4"	3/4" BSP	A128112	3,88
1"	1" BSP	A128116	6,08
1" 1/4	1" 1/4 BSP	A128120	10,36
1" 1/2	1" 1/2 BSP	A128124	13,59

## Hembras giratorias prensada 90° BSP 60° - soldable

*Crimped 90° BSP swivel female 60° weldable*

Embout à sertir coude 90° femelle tournante BSP 60° à souder

*Femmina 90° girevole BSP, a saldare con guida*

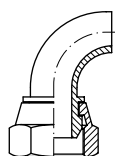

DN	THREAD ROSCA	Part n° Referencia	€
1/4"	1/4" BSP	A103704	2,21
3/8"	3/8" BSP	A103706	2,81
1/2"	1/2" BSP	A103708	4,66
3/4"	3/4" BSP	A103712	6,88
1"	1" BSP	A103716	11,21
1" 1/4	1" 1/4 BSP	A103720	18,05
1" 1/2	1" 1/2 BSP	A103724	26,74
2"	2" BSP	A103732	45,47

## Hembras giratorias prensada 45° BSP 60° - soldable

*Crimped 45° BSP swivel female 60° weldable*

Embout à sertir 45° femelle tournante BSP 60° à souder

*Femmina 45° girevole BSP, a saldare con guida*

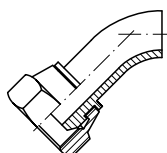

DN	THREAD ROSCA	Part n° Referencia	€
1/4"	1/4" BSP	A103804	2,25
3/8"	3/8" BSP	A103806	2,95
1/2"	1/2" BSP	A103808	4,21
3/4"	3/4" BSP	A103812	8,07
1"	1" BSP	A103816	11,21
1" 1/4	1" 1/4 BSP	A103820	18,05
1" 1/2	1" 1/2 BSP	A103824	26,74
2"	2" BSP	A103832	45,47

## Hembras giratorias prensada BSP asiento plano - soldable con guía

*Crimped BSP swivel female flat seat weldable*

Embout à sertir femelle tournante BSP à souder fond plat

*Femm. gir. BSP faccia piana, a saldare con guida*

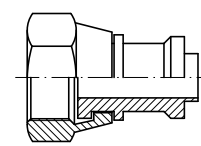

DN	THREAD ROSCA	Part n° Referencia	€
1/4"	1/4" BSP	A128204	1,57
3/8"	3/8" BSP	A128206	1,96
1/2"	1/2" BSP	A128208	3,37
3/4"	3/4" BSP	A128212	4,86
1"	1" BSP	A128216	8,16
1" 1/4	1" 1/4 BSP	A128220	14,75
1" 1/2	1" 1/2 BSP	A128224	21,58
2"	2" BSP	A128232	36,25

## Hembras giratorias prensada 90° BSP asiento plano - soldable

*Crimped 90° BSP swivel female 60° flat seat weldable*

Embout à sertir 90° femelle tournante BSP 60° à souder fond plat

*Femm. 90° gir. BSP faccia piana, a saldare con guida*



DN	THREAD ROSCA	Part n° Referencia	€
1/4"	1/4" BSP	A103904	2,59
3/8"	3/8" BSP	A103906	3,30
1/2"	1/2" BSP	A103908	4,71
3/4"	3/4" BSP	A103912	9,02
1"	1" BSP	A103916	11,21
1" 1/4	1" 1/4 BSP	A103920	20,18
1" 1/2	1" 1/2 BSP	A103924	29,89
2"	2" BSP	A103932	50,81

## Hembras giratorias prensada 45° BSP asiento plano - soldable

*Crimped 45° BSP swivel female 60° flat seat weldable*

Embout à sertir 45° femelle tournante BSP 60° à souder fond plat

*Femm. 45° gir. BSP faccia piana, a saldare con guida*

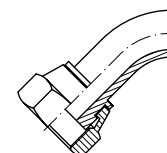

DN	THREAD ROSCA	Part n° Referencia	€
1/4"	1/4" BSP	A104004	2,75
3/8"	3/8" BSP	A104006	3,75
1/2"	1/2" BSP	A104008	5,10
3/4"	3/4" BSP	A104012	9,02
1"	1" BSP	A104016	11,21
1" 1/4	1" 1/4 BSP	A104020	20,18
1" 1/2	1" 1/2 BSP	A104024	29,89
2"	2" BSP	A104032	50,81

# Manguera Inox, Racores y Bridas soldables

Stainless steel hose, welding fittings and forged flanges

Tuyau Inox, raccords et brides à souder

Tubi Inox, raccordi e flange a saldare

## Hembra giratoria prensada JIC 37° - soldable con guía

*Crimped JIC 37° swivel female weldable*

Embout à sertir femelle tournante JIC37° à souder

*Femmina girevole JIC 37°, a saldare*

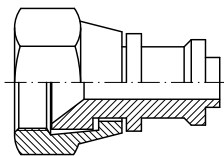

DN	THREAD ROSCA	Part nº Referencia	€
1/4"	7/16" 20h UNF	A12830704	1,37
1/4"	1/2" 20h UNF	A12830804	1,64
3/8"	9/16" 18h UNF	A12830906	1,77
3/8"	3/4" 16h UNF	A12831206	2,59
1/2"	3/4" 16h UNF	A12831208	2,59
1/2"	7/8" 14h UNF	A12831408	2,80
3/4"	1" 1/16 12h UNF	A12831712	4,23
1"	1" 5/16 12h UNF	A12832116	7,51
1" 1/4	1" 5/8 12h UNF	A12832620	12,42
1" 1/2	1" 7/8 12h UNF	A12833024	18,76

## Hembra giratoria 90° prensada JIC 37° - soldable

*Crimped 90° JIC 37° swivel female weldable*

Embout à sertir femelle tournante 90° JIC37° à souder

*Femmina 90° girevole JIC 37°, a saldare*

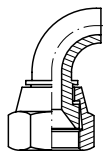

DN	THREAD ROSCA	Part nº Referencia	€
1/4"	7/16" 20h UNF	A10410704	2,35
1/4"	1/2" 20h UNF	A10410804	2,75
3/8"	9/16" 18h UNF	A10410906	3,30
1/2"	3/4" 16h UNF	A10411208	4,71
1/2"	7/8" 14h UNF	A10411408	4,67
3/4"	1" 1/16 12h UNF	A10411712	6,41
1"	1" 5/16 12h UNF	A10412116	10,68
1" 1/4	1" 5/8 12h UNF	A10412620	23,85
1" 1/2	1" 7/8 12h UNF	A10413024	34,13

## Macho JIC 37° - soldable con guía

*Weldable JIC 37° male with guide*

Mâle JIC 37° soldable avec guide

*Maschio JIC 37° a saldare con guida*

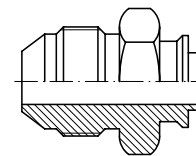

DN	THREAD ROSCA	Part nº Referencia	€
1/4"	7/16" 20h UNF	A10360704	1,14
1/4"	1/2" 20h UNF	A10360804	1,88
3/8"	9/16" 18h UNF	A10360906	1,40
3/8"	3/4" 16h UNF	A10361206	2,13
1/2"	3/4" 16h UNF	A10361208	2,13
1/2"	7/8" 14h UNF	A10361408	2,44
5/8"	7/8" 14h UNF	A10361410	3,14
3/4"	1" 1/16 12h UNF	A10361712	3,97
1"	1" 5/16 12h UNF	A10362116	9,42
1" 1/4	1" 5/8 12h UNF	A10362620	15,54
1" 1/4	1" 7/8 12h UNF	A10363020	20,17

## Hembra giratoria 45° prensada JIC 37° - soldable

*Crimped 45° JIC 37° swivel female weldable*

Embout à sertir femelle tournante 45° JIC 37° à souder

*Femmina 45° girevole JIC 37°, a saldare*

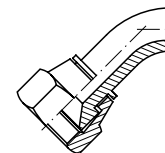

DN	THREAD ROSCA	Part nº Referencia	€
1/4"	7/16" 20h UNF	A10420704	2,59
1/4"	1/2" 20h UNF	A10420804	2,75
3/8"	9/16" 18h UNF	A10420906	3,37
1/2"	3/4" 16h UNF	A10421208	4,79
1/2"	7/8" 14h UNF	A10421408	5,96
3/4"	1" 1/16 12h UNF	A10421712	8,00
1"	1" 5/16 12h UNF	A10422116	11,05
1" 1/4	1" 5/8 12h UNF	A10422620	24,01
1" 1/2	1" 7/8 12h UNF	A10423024	35,31

# Manguera Inox, Racores y Bridas soldables

Stainless steel hose, welding fittings and forged flanges

Tuyau Inox, raccords et brides à souder

Tubi Inox, raccordi e flange a saldare

## Boquilla para soldar

Welding nipple

Collet cône Métrique (DIN 2353) à souder (BW)  
o'ring

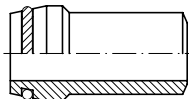

Ogiva a saldare

PIPE TUBO	SERIE	Part nº Referencia	€
15	L	ORIL 15	*
18	L	ORIL 18	*
22	L	ORIL 22	*
28	L	ORIL 28	*
8	S	ORIS 8X1.5	*
10	S	ORIS 10X2	*
12	S	ORIS 12X2.5	*
14	S	ORIS 14X2	*
14	S	ORIS 14X3	*
16	S	ORIS 16X2	*
16	S	ORIS 16X2.5	*
16	S	ORIS 16X3	*
20	S	ORIS 20X2.5	*
20	S	ORIS 20X3	*
20	S	ORIS 20X4	*
25	S	ORIS 25X4	*
30	S	ORIS 30X4	*
30	S	ORIS 30X5	*
38	S	ORIS 38X5	*

\*Ver precios en pág.193 / \*See prices page 193 / \*Voir les prix en page 193 / \*Vedere prezzi p.193

## Racor recto para soldar

Weldable straight coupling

Raccord droit à souder

Raccordo diritto a saldare

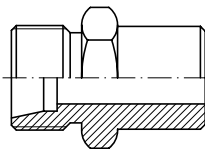

PIPE TUBO	SERIE	Part nº Referencia	€
6	L	STA ASL 6	*
8	L	STA ASL 8	*
10	L	STA ASL 10	*
12	L	STA ASL 12	*
15	L	STA ASL 15	*
18	L	STA ASL 18	*
22	L	STA ASL 22	*
28	L	STA ASL 28	*
35	L	STA ASL 35	*
42	L	STA ASL 42	*
6	S	STA ASS 6	*
8	S	STA ASS 8	*
10	S	STA ASS 10	*
12	S	STA ASS 12	*
14	S	STA ASS 14	*
16	S	STA ASS 16	*
20	S	STA ASS 20	*
25	S	STA ASS 25	*
30	S	STA ASS 30	*
38	S	STA ASS 38	*

\*Ver precios en pág.193 / \*See prices p.193 / \*Voir les prix en page 193 / \*Vedere prezzi p.193

## Tuerca Métrica DIN 3870

Nuts DIN 3870

Écrou Métrique DIN 3870

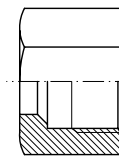

Dadi Metrici DIN 3870

PIPE TUBO	SERIE	THREAD ROSCA	Part nº Referencia	€
4	LL	M8x1	MLL 4 M 8X1	*
6	LL	M10x1	MLL 6 M 10X1	*
8	LL	M12x1	MLL 8 M 12X1	*
6	L	M12x1,5	ML 6 M 12X1.5	*
8	L	M14x1,5	ML 8 M 14X1.5	*
10	L	M16x1,5	ML 10 M 16X1.5	*
12	L	M18x1,5	ML 12 M 18X1.5	*
15	L	M22x1,5	ML 15 M 22X1.5	*
18	L	M26x1,5	ML 18 M 26X1.5	*
22	L	M30x2	ML 22 M 30X2	*
28	L	M36x2	ML 28 M 36X2	*
35	L	M45x2	ML 35 M 45X2	*
42	L	M52x2	ML 42 M 52X2	*
6	S	M14x1,5	MS 6 M 14X1.5	*
8	S	M16x1,5	MS 8 M 16X1.5	*
10	S	M18x1,5	MS 10 M 18X1.5	*
12	S	M20x1,5	MS 12 M 20X1.5	*
14	S	M22x1,5	MS 14 M 22X1.5	*
16	S	M24x1,5	MS 16 M 24X1.5	*
20	S	M30x2	MS 20 M 30X2	*
25	S	M36x2	MS 25 M 36X2	*
30	S	M42x2	MS 30 M 42X2	*
38	S	M52x2	MS 38 M 52X2	*

\*Ver precios en pág.180 / \*See prices page 180 / \*Voir les prix en page 180 / \*Vedere prezzi p.180

# Manguera Inox, Racores y Bridas soldables

Stainless steel hose, welding fittings and forged flanges

Tuyau Inox, raccords et brides à souder

Tubi Inox, raccordi e flange a saldare

## Hembra giratoria 45 pasada métrica - soldable

Metric weldable swivel female 45°

Femelle tournante 45° métrique à souder

Femmina girevole 45° metrica a saldare

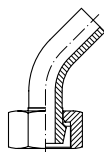

PIPE TUBO	SERIE	THREAD ROSCA	Part nº Referencia	€
6	L	12X1,5	A10531206	3,92
8	L	14x1,5	A10531408	2,01
10	L	16X1,5	A10531610	2,90
12	L	18X1,5	A10531812	2,50
15	L	22X1,5	A10532215	3,60
18	L	26X1,5	A10532618	5,45
22	L	30X2	A10533022	7,63
28	L	36X2	A10533628	16,48
35	L	45X2	A10534535	25,34
42	L	52X2	A10535242	41,74
6	S	14x1,5	A10531406	3,92
8	S	16X1,5	A10531608	2,98
10	S	18X1,5	A10531810	3,14
12	S	20X1,5	A10532012	3,92
14	S	22X1,5	A10532214	4,55
16	s	24x1,5	A10532416	4,27
20	S	30X2	A10533020	9,55
25	S	36X2	A10533625	13,73
30	S	42X2	A10534230	21,58
38	S	52X2	A10535238	34,52

## Hembra giratoria 90 pasada métrica - soldable

Metric weldable swivel female 90°

Femelle tournante 90° métrique à souder

Femmina girevole 90° metrica a saldare

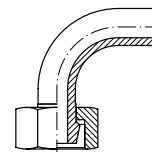

PIPE TUBO	SERIE	THREAD ROSCA	Part nº Referencia	€
6	L	12X1,5	A10521206	3,92
8	L	14X1,5	A10521408	2,59
10	L	16X1,5	A10521610	2,90
12	L	18X1,5	A10521812	3,14
15	L	22X1,5	A10522215	4,55
18	L	26X1,5	A10522618	7,01
22	L	30X2	A10523022	10,04
28	L	36X2	A10523628	16,48
35	L	45X2	A10524535	25,27
42	L	52X2	A10525242	41,74
6	S	14X1,5	A10521406	3,92
8	S	16X1,5	A10521608	2,90
10	S	18X1,5	A10521810	3,14
12	S	20X1,5	A10522012	3,05
14	S	22X1,5	A10522214	4,55
16	S	24X1,5	A10522416	4,91
20	S	30X2	A10523020	8,54
25	S	36X2	A10523625	13,73
30	S	42X2	A10524230	21,58
38	S	52X2	A10525238	34,52

# Manguera Inox, Racores y Bridas soldables

Stainless steel hose, welding fittings and forged flanges

Tuyau Inox, raccords et brides à souder

Tubi Inox, raccordi e flange a saldare

## Cono ajuste 60° con guía

Welding nipple 60° cone for BSP nut with guide

Collet cône 60° à souder (bw) + guide

Nipplo a saldare sede 60° per dado BSP con guida

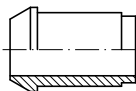

DN	THREAD ROSCA	Part n° Referencia	€
3/8"	3/8" BSP	A127806	0,64
1/2"	1/2" BSP	A127808	1,35
3/4"	3/4" BSP	A127812	1,98
1"	1" BSP	A127816	2,37
1"1/4	1"1/4 BSP	A127820	5,39
1"1/2	1"1/2 BSP	A127824	7,57
2"	2" BSP	A127832	13,04

Hasta fin de existencias. / Until end of stock. / Jusqu'à fin du stock. / Fino ad esaurimento scorta.

## Tuerca para cono ajuste 60° BSP

BSP nut for welding nipple 60° cone

Écrou BSP pour collet à souder bw (60°)

Dado BSP per nipplo a saldare 60°

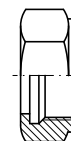

THREAD ROSCA	Part n° Referencia	€
1/4" BSP	A127004	0,87
3/8" BSP	A127006	0,82
1/2" BSP	A127008	1,05
3/4" BSP	A127012	1,19
1" BSP	A127016	2,65
1"1/4 BSP	A127020	5,47
1"1/2 BSP	A127024	7,30
2" BSP	A127032	11,31

## Cono ajuste sin guía

Welding nipple without guide

Collet à souder sans guide

Ogiva a saldare BSP

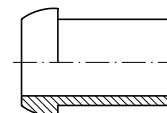

DN	THREAD ROSCA	Part n° Referencia	€
1/4"	1/4" BSP	A127304	0,55
3/8"	3/8" BSP	A127306	0,55
1/2"	1/2" BSP	A127308	1,00
3/4"	3/4" BSP	A127312	1,19
1"	1" BSP	A127316	2,10
1"1/4	1"1/4 BSP	A127320	3,01
1"1/2	1"1/2 BSP	A127324	5,29
2"	2" BSP	A127332	7,48

## Espiga lisa métrica recta

Metric standpipe

Embout lisse métrique droit

Estremità tubolare diritta Metrica

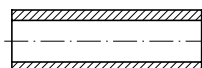

Ø OUTER Ø EXT.	Ø INNER Ø INT.	Part n° Referencia	€
6	4	KL0006	0,91
8	4	KL0008	0,91
10	6	KL0010	1,28
12	8	KL0012	6,36
14	10	KL0014	3,48
15	11	KL0015	2,46
16	11	KL0016	2,68
18	14	KL0018	3,87
20	12	KL0020	5,27
22	18	KL0022	7,42

## Tuercas BSP Microfundido AISI-316 >2"

Micro-casting BSP nuts AISI-316 >2"

Écrou BSP en acier moulé AISI-316 >2"

Dadi BSP microfusi AISI-316 >2"

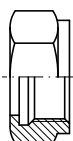

THREAD ROSCA	Part n° Referencia	€
2"1/2 BSP	Z127040	118,40
3" BSP	Z127048	148,54
4" BSP	Z127064	196,98

## Cono ajuste BSP 60° con guía >2"

Welding nipple with 60° cone for BSP nut with guide >2"

Collet à souder BSP cone 60° avec guide <2"

Ogiva a saldare cono 60° con guida per dado BSP >2"

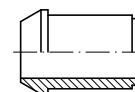

DN	THREAD ROSCA	Part n° Referencia	€
2"1/2	2"1/2 BSP	Z127840	94,48
3"	3" BSP	Z127848	117,22
4"	4" BSP	Z127864	171,30

## Macho BSPT soldar microfundido AISI-316 >2"

Micro-casting BSPT welding male AISI-316 >2"

Mâle BSPT à souder en acier moulé AISI-316 >2"

Maschio BSPT a saldare microfuso AISI-316 >2"

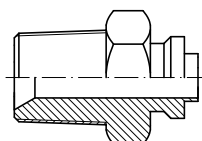

DN	THREAD ROSCA	Part n° Referencia	€
2"1/2	2"1/2 BSPT	ZM103240	124,32
3"	3" BSPT	ZM103248	152,43
4"	4" BSPT	ZM103264	192,43



# Manguera Inox, Racores y Bridas soldables

Stainless steel hose, welding fittings and forged flanges

Tuyau Inox, raccords et brides à souder

Tubi Inox, raccordi e flange a saldare

## Brida fija DIN 2633 PN 10/16

Fixed forged flange DIN 2633 PN 10/16

Bride fixe avec collerette DIN 2633 PN 10/16 à souder

Flangia fissa a saldare DIN 2633 PN 10/16

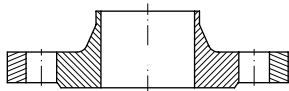

DN	Part nº Referencia	€
3/8"	BPN16263306	12,85
1/2"	BPN16263308	16,74
3/4"	BPN16263312	23,44
1"	BPN16263316	25,24
1"1/4	BPN16263320	25,64
1"1/2	BPN16263324	28,46
2"	BPN16263332	38,40
2"1/2	BPN16263340	58,10
3"	BPN16263348	70,69
4"	BPN16263364	91,61

## Brida ANSI-ASA Neck 150 LBS

Flange ANSI-ASA w. Neck 150 LBS

Bride ANSI-ASA w. Neck 150 LBS

Flangia ANSI-ASA 150 LBS

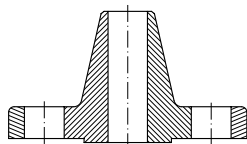

DN	Part nº Referencia	€
1/2"	BANSAWN15008	16,68
3/4"	BANSAWN15012	16,54
1"	BANSAWN15016	19,85
1"1/4	BANSAWN15020	23,82
1"1/2	BANSAWN15024	28,58
2"	BANSAWN15032	37,75
2"1/2	BANSAWN15040	42,47
3"	BANSAWN15048	51,29
4"	BANSAWN15064	82,82

## Brida fija DIN 2635 PN 40

Fixed forged flange DIN 2635 PN 40

Bride fixe avec collerette DIN 2635 PN 40 à souder

Flangia fissa a saldare DIN 2635 PN 40

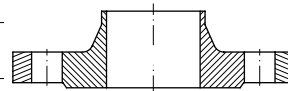

DN	Part nº Referencia	€
3/8"	BPN40263506	3,98
1/2"	BPN40263508	6,55
3/4"	BPN40263512	9,17
1"	BPN40263516	11,27
1"1/4	BPN40263520	16,53
1"1/2	BPN40263524	20,37
2"	BPN40263532	24,63
2"1/2	BPN40263540	48,12
3"	BPN40263548	59,12
4"	BPN40263564	48,36

## Brida ANSI-ASA Neck 300 LBS

Flange ANSI-ASA w. Neck 300 LBS

Bride ANSI-ASA w. Neck 300 LBS

Flangia ANSI-ASA Neck 300 LBS

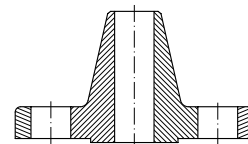

DN	Part nº Referencia	€
1/2"	BANSAWN30008	16,89
3/4"	BANSAWN30012	22,50
1"	BANSAWN30016	22,62
1"1/4	BANSAWN30020	30,02
1"1/2	BANSAWN30024	31,23
2"	BANSAWN30032	35,55
2"1/2	BANSAWN30040	41,31
3"	BANSAWN30048	82,82
4"	BANSAWN30064	125,54

# Manguera Inox, Racores y Bridas soldables

Stainless steel hose, welding fittings and forged flanges

Tuyau Inox, raccords et brides à souder

Tubi Inox, raccordi e flange a saldare

## Brida loca DIN 2642 PN 10/16

Swivel forged flange DIN 2642 PN 10/16

Bride plate tournante DIN 2642 PN 10/16 à souder

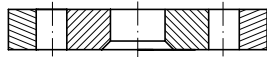

Flangia girevole a saldare DIN 2642 PN 10/16

DN	Part nº Referencia	€
3/8"	BPN10264206	8,57
1/2"	BPN10264208	9,03
3/4"	BPN10264212	10,58
1"	BPN10264216	14,96
1 1/4"	BPN10264220	23,90
1 1/2"	BPN10264224	24,45
2"	BPN10264232	31,63
2 1/2"	BPN10264240	33,24
3"	BPN10264248	39,57
4"	BPN10264264	61,12

## Aro para brida DIN 2642

Ring for flange DIN 2642

Collet épais pour bride DIN 2642

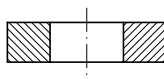

Anello per flangia DIN 2642

DN	Part nº Referencia	€
3/8"	ABARO264206	4,19
1/2"	ABARO264208	5,46
3/4"	ABARO264212	6,50
1"	ABARO264216	10,10
1 1/4"	ABARO264220	13,09
1 1/2"	ABARO264224	11,48
2"	ABARO264232	17,21
2 1/2"	ABARO264240	17,34
3"	ABARO264248	22,68
4"	ABARO264264	55,13

## Tubo soldar brida ANSI-DIN

Tube for welding flanges ANSI-DIN

Tube à souder brides ANSI-DIN

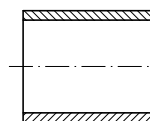

Tubo per flangia a saldare ANSI-DIN

DN	Part nº Referencia	€
3/8"	ABTUB006	2,06
1/2"	ABTUB008	2,13
3/4"	ABTUB012	2,63
1"	ABTUB016	3,19
1 1/4"	ABTUB020	4,05
1 1/2"	ABTUB024	5,11
2"	ABTUB032	6,81
2 1/2"	ABTUB040	8,30
3"	ABTUB048	9,44
4"	ABTUB064	11,43

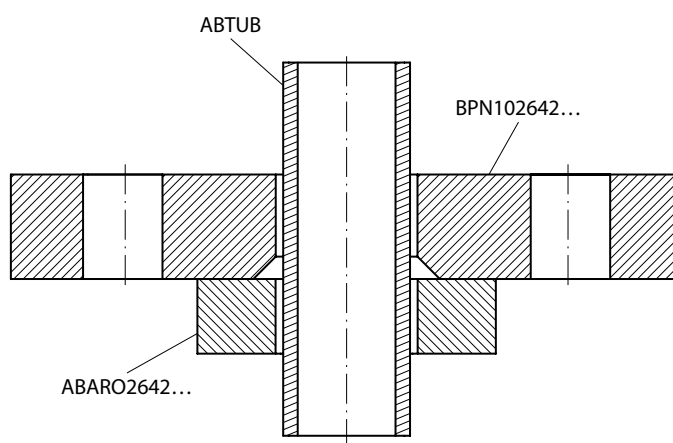

# Manguera Inox, Racores y Bridas soldables

Stainless steel hose, welding fittings and forged flanges

Tuyau Inox, raccords et brides à souder

Tubi Inox, raccordi e flange a saldare

## Brida loca DIN 2656 PN 40

Swivel forged flange DIN 2656 PN 40

Bride plate tournante DIN 2656 PN 40 à souder

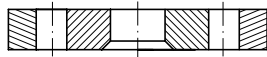

Flangia girevole a saldare DIN 2656 PN 40

DN	Part n° Referencia	€
3/8"	BPN40265606	3,62
1/2"	BPN40265608	6,11
3/4"	BPN40265612	7,39
1"	BPN40265616	9,95
1"1/4	BPN40265620	15,87
1"1/2	BPN40265624	22,44
2"	BPN40265632	32,69
2"1/2	BPN40265640	37,00
3"	BPN40265648	27,09
4"	BPN40265664	63,22

## Aro para brida DIN 2656

Ring for flange DIN 2656

Collet épais pour bride DIN 2656

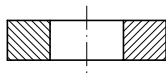

Anello per flangia DIN 2656

DN	Part n° Referencia	€
3/8"	ABARO265606	5,63
1/2"	ABARO265608	6,98
3/4"	ABARO265612	6,57
1"	ABARO265616	8,88
1"1/4	ABARO265620	9,50
1"1/2	ABARO265624	11,04
2"	ABARO265632	16,60
2"1/2	ABARO265640	19,87
3"	ABARO265648	30,93

## Tubo soldar brida ANSI-DIN

Tube for welding flanges ANSI-DIN

Tube à souder brides ANSI-DIN

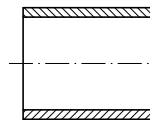

Tubo per flangia a saldare ANSI-DIN

DN	Part n° Referencia	€
3/8"	ABTUB006	2,06
1/2"	ABTUB008	2,13
3/4"	ABTUB012	2,63
1"	ABTUB016	3,19
1"1/4	ABTUB020	4,05
1"1/2	ABTUB024	5,11
2"	ABTUB032	6,81
2"1/2	ABTUB040	8,30
3"	ABTUB048	9,44
4"	ABTUB064	11,43

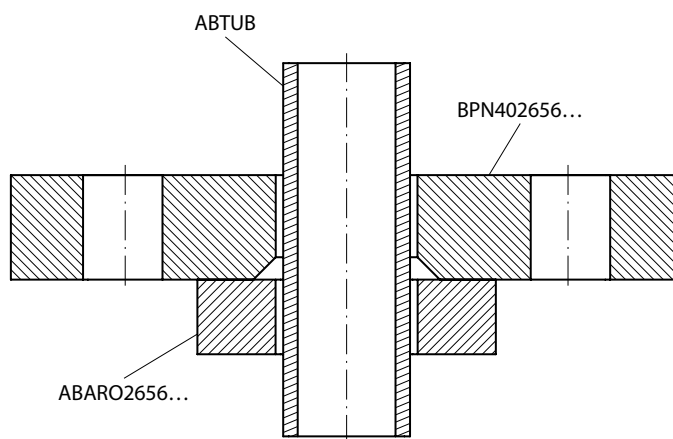

# Manguera Inox, Racores y Bridas soldables

Stainless steel hose, welding fittings and forged flanges

Tuyau Inox, raccords et brides à souder

Tubi Inox, raccordi e flange a saldare

## Brida loca ANSI-ASA 150 LBS

Swivel flange ANSI-ASA 150 LBS

Bride tourn. ANSI-ASA 150 LBS



Flangia ANSI-ASA 150 LBS

DN	Part n° Referencia	€
1/2"	BANSASO15008	11,68
3/4"	BANSASO15012	7,17
1"	BANSASO15016	7,92
1"1/4	BANSASO15020	10,33
1"1/2	BANSASO15024	18,06
2"	BANSASO15032	33,55
2"1/2	BANSASO15040	37,23
3"	BANSASO15048	50,37
4"	BANSASO15064	53,00

## Brida loca ANSI-ASA 300 LBS

Swivel flange ANSI-ASA 300 LBS

Bride tourn. ANSI-ASA 300 LBS



Flangia ANSI-ASA 300 LBS

DN	Part n° Referencia	€
1/2"	BANSASO30008	12,82
3/4"	BANSASO30012	18,40
1"	BANSASO30016	13,11
1"1/4	BANSASO30020	15,97
1"1/2	BANSASO30024	23,52
2"	BANSASO30032	22,44
2"1/2	BANSASO30040	33,05
3"	BANSASO30048	54,09
4"	BANSASO30064	85,33

## Tubo soldar brida ANSI-DIN

Tube for welding flanges ANSI-DIN

Tube à souder brides ANSI-DIN

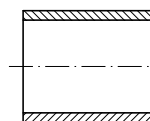

Tubo per flangia a saldare ANSI-DIN

DN	Part n° Referencia	€
3/8"	ABTUB006	2,06
1/2"	ABTUB008	2,13
3/4"	ABTUB012	2,63
1"	ABTUB016	3,19
1"1/4	ABTUB020	4,05
1"1/2	ABTUB024	5,11
2"	ABTUB032	6,81
2"1/2	ABTUB040	8,30
3"	ABTUB048	9,44
4"	ABTUB064	11,43

## Aro para brida ANSI-ASA 150/300 LBS

Ring for welding flanges ANSI-ASA 150/300 LBS

Collet épais pour bride ANSI-ASA 150/300 LBS

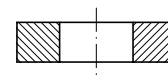

Anello per flangia ANSI-ASA 150/300 LBS

DN	Part n° Referencia	€
1/2"	ABAROANSA08	2,93
3/4"	ABAROANSA12	3,52
1"	ABAROANSA16	5,71
1"1/4	ABAROANSA20	5,26
1"1/2	ABAROANSA24	6,68
2"	ABAROANSA32	10,29
2"1/2	ABAROANSA40	14,30
3"	ABAROANSA48	18,77
4"	ABAROANSA64	28,97

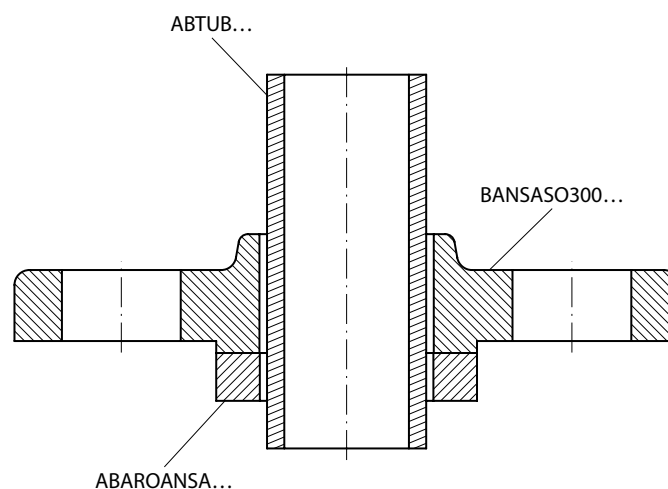
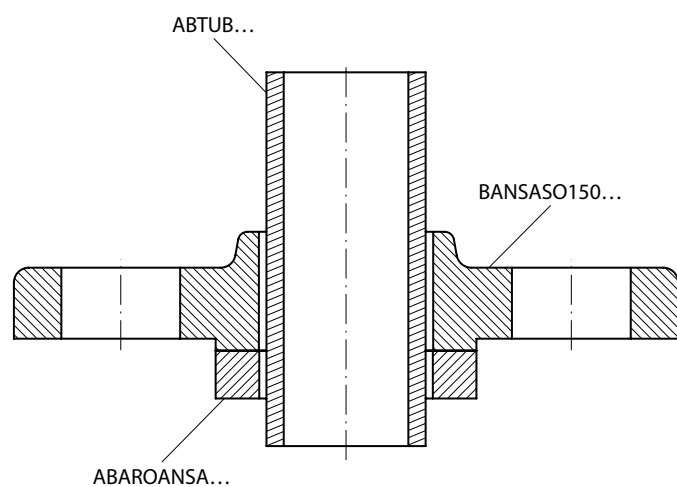

# MONTAJE DE LATIGUILLOS

*MOUNTING FLEXIBLES*



## Baja presión

*Low pressure*

Basse pression

*Tubi a bassa pressione*

### Manguera baja presión

*Low pressure hose*

Tuyau basse pression

*Tubi bassa pressione*

153

### Racores baja presión

*Low pressure fittings*

Raccords basse pression

*Raccordi bassa pressione*

154

4

## Manguera baja presión

Low pressure hose  
Tuyau basse pression  
Tubi bassa pressione

- **Mangueras de caucho sintético / Synthetic rubber hoses (diesel oil) / Tuyaux de caoutchouc synthétique (gas-oil) / Tubi di caucciú sintético (diesel)**

| 153



M100



M110

## Racores baja presión

Low pressure fittings  
Raccords basse pression  
Raccordi bassa pressione

- **Casquillos (campanillas) / Sleeves / Jupes basse pression / Boccole (in acciaio sottile)**

| 154



A5010

- **Conexiones BSP / BSP Fittings / Embouts BSP basse pression / Raccordi BSP**

| 154



D5030



D5052



D5050



D5042



D5040



D5091

- **Conexiones Métricas / Metric fittings / Embouts Métriques basse pression / Raccordi Metrici**

| 156



D5070



D5082



D5080



D5090



D5062



D5060



D5085



D5020



# Manguera baja presión

Low pressure hose  
Tuyau basse pression  
Tubi bassa pressione

## Manguera de caucho sintético con una malla de acero galvanizado (gasoil)

Synthetic rubber hose with a galvanized steel braided (gasoil)

Tuyau de caoutchouc synthétique avec une tresse d'acier galvanisé (gasoil)

Tubo di caucciú sintético con una maglia di acciaio galvanizzato (gasolio)



Ø INNER Ø INT.	Part nº Referencia	€
5	M10005	4,59
6	M10006	5,30
7	M10007	5,62
8	M10008	6,39
9	M10009	7,26
12	M10012	10,43
14	M10014	11,41
15	M10015	13,65
18	M10018	16,76
20	M10020	18,24
22	M10022	20,20
26	M10025	23,81
30	M10030	30,30
40	M10040	74,58
50	M10050	99,59

## Manguera de caucho sintético con una malla textil de alta tenacidad (gasoil y gasolina)

Synthetic rubber hose with a textile braided high toughness (gasoil and gasolina)

Tuyau de caoutchouc synthétique avec une tresse textile d'haute tenacité (gasoil et essence)

Tubo di caucciú sintético con una maglia tessile ad alta resistenza (gasolio e benzina)



Ø INNER Ø INT.	Part nº Referencia	€
4	M11004	4,15
5	M11005	4,53
6	M11006	5,24
7	M11007	5,90
8	M11008	5,73
9	M11009	7,32
12	M11012	11,14

## Máquina prensar baja presión | Low pressure crimping machine | Presse basse pression | Macchina pressatubi bassa pressione



PBPH25PI



PBPH25

**Mordazas incluidas** | Included dies | Mors inclus | Morsetti inclusi  
Ø10-13-16 mm.

Ø máx. | Ø max. | Ø max. | Ø massimo

25 mm. 25 mm.

**Apertura** | Opening | Overture | Apertura

+21 mm. +21 mm.

**Peso** | Weight | Poids | Peso

25 kg. 12 kg.

**Dimensiones** | Dimensions | Dimensions | Dimensioni

500 x 180 x 310 mm.

**Alimentación neumática** | Pneumatic input |

Alimentation Pneumatique | Alimentazione pneumatica

Máx. 7 bar.

**Mordazas incluidas** | Included dies | Mors inclus | Morsetti inclusi  
Ø10-13-16 mm.

Ø máx. | Ø max. | Ø max. | Ø massimo

**Apertura** | Opening | Overture | Apertura

**Peso** | Weight | Poids | Peso

**Dimensiones** | Dimensions | Dimensions | Dimensioni

500 x 180 x 310 mm.

# Racores baja presión

Low pressure fittings  
Raccords basse pression  
Raccordi bassa pressione

## Campanillas de plancha para manguera de baja presión

Sleeves for low pressure hose

Jupes acier doux malléable pour tuyau basse pression

Boccola in acciaio sottile per tubo bassa pressione



Ø OUTER Ø EXT.	Ø INNER Ø INT.	Part n° Referencia	€
11,6	10,5	A50101050000	0,28
13,7	12,4	A50101200000	0,30
14,7	13,5	A50101350000	0,32
15,6	14,5	A50101450000	0,32
16,5	15,5	A50101550000	0,35
18,8	17,3	A50101700000	0,41
19,5	18,5	A50101850000	0,42
22,9	20,5	A50102050000	0,52
23,9	22,5	A50102250000	0,60
26,2	24,5	A50102450000	0,68
28	26,4	A50102600000	0,73
30	28	A50102800000	0,83
32,2	30	A50103000000	1,33
35,5	33,5	A50103300000	1,34
38,2	36	A50103600000	1,49
45,2	42,2	A50104200000	4,90
60,8	56	A50105600000	6,05
65,5	61	A50106100000	7,65
70,3	66,5	A50106650000	10,47
76,7	71	A50107100000	8,87

## Tuerca BSP

BSP Nut

Ecrou BSP

Dado BSP



THREAD ROSCA	Part n° Referencia	€
1/4" BSP	D50300400000	0,80
3/8" BSP	D50300600000	0,88
1/2" BSP	D50300800000	1,25
3/4" BSP	D50301200000	1,74
1" BSP	D50301600000	2,99
1"1/4 BSP	D50302000000	8,08
1"1/2 BSP	D50302400000	9,52
2" BSP	D50303200000	16,32

## Boquilla asiento cónico 60° (BSP) baja presión

BSP Nipple 60° cone low pressure

Nipple embout femelle BSP 60° basse pression

Inserto cono 60° BSP bassa pressione



DN	NUT TUERCA	Part n° Referencia	€
5-6	1/4"	D50520405000	1,19
7-8	1/4"	D50520407000	0,96
7-8	3/8"	D50520607000	1,22
9-10	3/8"	D50520609000	1,04
12-13	1/2"	D50520812000	1,12
15-16	1/2"	D50520815000	1,12
15-16	3/4"	D50521216000	1,98
19-20	3/4"	D50521220000	1,68
19-20	1"	D50521620000	4,02
25	1"	D50521625000	3,52
30	1"1/4	D50522030000	7,20
40	1"1/2	D50522440000	11,76
50	2"	D50523250000	19,60

# Racores baja presión

Low pressure fittings  
Raccords basse pression  
Raccordi bassa pressione

## Boquilla asiento plano (BSP) baja presión

*BSP Nipple flat seat*

Nipple embout femelle fond plat BSP basse pression

*Inserto faccia piana BSP bassa pressione*



PIPE TUBO	NUT TUERCA	Part n° Referencia	€
5-6	1/4"	D50500405000	1,19
7-8	1/4"	D50500407000	1,19
9-10	3/8"	D50500609000	1,22
12-13	1/2"	D50500812000	1,39
15-16	1/2"	D50500815000	1,39
15-16	3/4"	D50501216000	1,98
19-20	3/4"	D50501220000	1,98
19-20	1"	D50501620000	4,02
25	1"	D50501625000	3,44
30	1"1/4	D50502030000	7,84
40	1"1/2	D50502440000	15,10
50	2"	D50503250000	19,93

## Macho BSP rosca cilíndrica asiento cónico 60°

*BSP Cylindrical male low pressure 60° cone*

Embout mâle fixe BSP cône 60° basse pression

*Maschio BSP cilindrico sede conica 60° bassa pressione*



PIPE TUBO	THREAD ROSCA	Part n° Referencia	€
5-6	1/4"	D50420405000	2,19
7-8	1/4"	D50420407000	2,48
7-8	3/8"	D50420607000	2,39
9-10	3/8"	D50420609000	2,40
12-13	3/8"	D50420612000	2,82
12-13	1/2"	D50420812000	4,56
15-16	1/2"	D50420815000	2,91
15-16	3/4"	D50421216000	4,28
19-20	3/4"	D50421220000	3,83
19-20	1"	D50421620000	7,50
25	1"	D50421625000	6,05
30	1"1/4	D50422030000	19,69
40	1"1/2	D50422440000	24,28
50	2"	D50423250000	32,03

## Macho BSP rosca cilíndrica asiento plano

*Low pressure BSP cylindrical male flat seat*

Embout mâle gaz fond plat basse pression

*Maschio BSP cilindrico sede piana bassa pressione*



PIPE TUBO	THREAD ROSCA	Part n° Referencia	€
5-6	1/8"	D50400205000	1,56
5-6	1/4"	D50400405000	2,19
7-8	1/4"	D50400407000	2,11
7-8	3/8"	D50400607000	2,39
9-10	3/8"	D50400609000	2,39
12-13	1/2"	D50400812000	2,82
15-16	1/2"	D50400815000	2,91
15-16	3/4"	D50401216000	4,28
19-20	3/4"	D50401220000	4,16
19-20	1"	D50401620000	7,50
25	1"	D50401625000	6,90
30	1"1/4	D50402030000	19,69
40	1"1/2	D50402440000	23,27
50	2"	D50403250000	32,03

## Codo 90° baja gas cono 60°

*90° BSP Swivel female 60° cone low pressure*

Embout femelle 90° gaz cyl BSP 60° basse pression

*Femmina a 90° sede 60° bassa pressione*



PIPE TUBO	THREAD ROSCA	Part n° Referencia	€
5-6	1/4"	D50910405000	5,91
7-8	1/4"	D50910407000	4,60
7-8	3/8"	D50910607000	6,00
9-10	3/8"	D50910609000	6,00
12-13	1/2"	D50910812000	8,55
15-16	1/2"	D50910815000	8,55
15-16	3/4"	D50911216000	17,30
19-20	3/4"	D50911220000	17,46
19-20	1"	D50911620000	26,33
25	1"	D50911625000	19,20
30	1"1/4	D50912030000	61,95

# Racores baja presión

Low pressure fittings  
Raccords basse pression  
Raccordi bassa pressione

## Tuerca Métrica

Metric nut

Écrou métrique

Dado Metrico



THREAD ROSCA	Part nº Referencia	€
M10X1	D50701000000	0,92
M12X1,5	D507012000000	1,02
M14X1,5	D507014000000	1,29
M16X1,5	D507016000000	1,39
M18X1,5	D507018000000	1,65
M22X1,5	D507022000000	2,23
M26X1,5	D507026000000	3,02

## Boquilla asiento cónico 60° (Métrica) baja presión

Metric nipple 60° cone low pressure

Nipple pour embout femelle DIN métrique cône 60° basse pression

Inserto cono 60° Metrico bassa pressione



PIPE TUBO	NUT TUERCA	Part nº Referencia	€
5-6	10X1	D50821005000	1,33
7-8	12X1,5	D50821207000	1,51
9-10	14X1,5	D50821409000	1,56
8-9	16X1,5	D50821609000	1,65
9-10	18X1,5	D50821810000	2,02
12-13	22X1,5	D50822212000	2,23
15-16	22X1,5	D50822215000	2,23
12-13	26X1,5	D50822612000	3,75
15-16	26X1,5	D50822615000	3,75

## Boquilla asiento plano (Métrica) baja presión

Metric nipple flat seat low pressure

Nipple pour embout femelle métrique fond plat basse pression

Inserto faccia piana bassa pressione



PIPE TUBO	NUT TUERCA	Part nº Referencia	€
5-6	10X1	D50801005000	1,33
7-8	12X1,5	D50801207000	1,49
9-10	14X1,5	D50801409000	1,56
9-10	16X1,5	D50801609000	1,42
9-10	18X1,5	D50801810000	2,09
12-13	22X1,5	D50802212000	2,23
15-16	22X1,5	D50802215000	1,68
12-13	26X1,5	D50802612000	3,75
15-16	26X1,5	D50802615000	3,75

## Boquilla en codo 90° asiento cónico 60° (métrico) baja presión

Nipple in 90° metric swivel female tapered seat low pressure 60°

Nipple en embout femelle 90° DIN métrique cône 60° basse pression

Femmina a 90° Metrica sede conica 60°



PIPE TUBO	THREAD ROSCA	Part nº Referencia	€
5-6	10X1	D50901006000	6,72
7-8	12X1,5	D50901207000	7,17
9-10	14X1,5	D50901409000	7,50
9-10	16X1,5	D50901609000	8,37

## Macho rosca Métrica asiento cónico 60° baja presión

Metric cylindrical male 60° cone

Embout mâle DIN métrique cône 60° basse pression

Maschio Metrico sede conica 60° bassa pressione



PIPE TUBO	THREAD ROSCA	Part nº Referencia	€
5-6	10X1	D50621005000	2,31
7-8	12X1,5	D50621207000	2,65
9-10	14X1,5	D50621409000	2,76
9-10	16X1,5	D50621609000	3,18
12-13	16X1,5	D50621612000	3,49
9-10	18X1,5	D50621810000	3,87
12-13	22X1,5	D50622212000	4,57
15-16	22X1,5	D50622215000	4,57
12-13	26X1,5	D50622612000	5,23
15-16	26X1,5	D50622615000	5,23

## Macho rosca Métrica asiento plano baja presión

Metric cyl male flat seat low pressure

Embout mâle métrique fond plat basse pression

Maschio Metrico sede piana bassa pressione



PIPE TUBO	THREAD ROSCA	Part nº Referencia	€
5-6	10X1	D50601005000	2,31
7-8	12X1,5	D50601207000	2,65
9-10	14X1,5	D50601409000	2,76
9-10	16X1,5	D50601609000	3,18
12-13	16X1,5	D50601612000	3,47
9-10	18X1,5	D50601810000	3,87
12-13	22X1,5	D50602212000	3,57
15-16	22X1,5	D50602215000	3,37
12-13	26X1,5	D50602612000	5,25
15-16	26X1,5	D50602615000	5,25

# Racores baja presión

Low pressure fittings  
Raccords basse pression  
Raccordi bassa pressione

## Espiga lisa Métrica baja presión

Metric standpipe low pressure

Embout lisse métrique basse pression



Estremità tubolare Metrica bassa pressione

PIPE TUBO		Part nº Referencia	€
5-6	4	D50850405000	4,85
5-6	6	D50850606000	2,76
5-6	8	D50850806000	2,76
7-8	8	D50850808000	2,76
7-8	10	D50851008000	2,97
9-10	10	D50851010000	2,97
12-13	12	D50851212000	3,09
15,5	15	D50851515000	4,92
15-16	18	D50851815000	4,98

## Orientable métrico baja presión

Low pressure metric banjo

Embout banjo métrique basse pression



Raccordo ad occhio Metrico bassa pressione

PIPE TUBO	Ø	Part nº Referencia	€
5-6	8	D50200805	3,80
7-8	8	D50200807	3,80
5-6	10	D50201005	4,16
7-8	10	D50201007	4,16
9-10	10	D50201009	4,24
5-6	12	D50201205	4,33
7-8	12	D50201207	4,33
9-10	12	D50201209	4,33
5-6	14	D50201405	4,47
7-8	14	D50201407	4,47
9-10	14	D50201409	4,47

## Aire acondicionado

*Air conditioning hoses and fittings*

Climatisation

*Aria condizionata*

## Racores aire acondicionado

*Air conditioning fittings*

Raccords climatisation

*Raccordi aria condizionata*

163

5

# Racores aire acondicionado

*Air conditioning fittings*  
*Raccords climatisation*  
*Raccordi aria condizionata*

## ■ Rotalock sin válvula / Rotalock without valve / Raccords Rotalock sans vanne / Raccordi Rotalock senza valvola

| 163



M5200

FXR

FX90

FX45

FXA90

## ■ Rotalock con válvula / Rotalock with valve / Raccords Rotalock avec vanne / Raccordi Rotalock con valvola

| 163



FXRV

FX45V

FX90V

FXAV90

## ■ Racores de unión / Couplings / Raccord union / Raccordi di unione

| 164



134 URTV

URT

## ■ Hembras con junta tórica sin válvula / Swivel female with green joint / Femelles tournantes avec joint vert sans vanne / Femmine con o'ring senza valvola

| 164



FOR

F045

F090

## ■ Hembras con junta tórica con válvula / Swivel female with green joint with valve / Femelles tournantes avec joint vert et avec vanne / Femmine con o'ring e valvola

| 164



FORV

F090V

F045V

## ■ Machos con junta tórica / Males with green joint / Mâles avec joint vert / Maschi con o'ring

| 165



MOR

M045

M090

## ■ Conexiones rosca SAE / Swivel females SAE / Femelles tournantes SAE / Raccordi SAE

| 165



FSR

F590

F545

## ■ Conexiones con válvula para Freón 12 / Fittings with valve for air conditioning 12 / Embouts climatisation pour Freón 12 avec vanne / Raccordi con valvola per Freon 12

| 166



FXRV

FXAV90

URTV

FX90V



# Racores aire acondicionado

*Air conditioning fittings*  
*Raccords climatisation*  
*Raccordi aria condizionata*

■ Juntas tóricas y racores recuperables / Joints and reusable fittings / Joints toriques et raccords récupérables / O'ring e raccordi recuperabili

| 166



\*FREON



CRF

# Mangueras

Hoses  
Tuyaux  
Tubi



## Mangueras Freón Barrier N (polivalente) Freón 134, 12...

*Air Conditioning Barrier N Hose Freon 134, 12...*  
*Tuyaux Freon Barrier N (Polyvalent) Freon 134, 12...*  
*Tubo Freon Barrier N (polivalente) Freon 134, 12...*

Tubo Hose Tuyau DN Tubi	Galga Gauge Pipe Size	Referencia Part Number Référence Codice
BARRIER N 5/16	6	M520006
BARRIER N 13/32	8	M520008
BARRIER N 1/2	10	M520010
BARRIER N 5/8	12	M520012

### Está compuesta por Nitrilo, Nylon y Neopreno. Cubierta exterior de EPDM resistente al calor, abrasión y al exterior.

*Tube: Nitrile, Nylon and Neoprene. Outer cover of EPDM, heat, abrasion and ozone resistant.*

*Composé de Nitrile, Nylon et Neoprene. Revêtement extérieur d'EPDM résistant à la chaleur, à l'abrasion et à l'ozone.*

*E' composta da Nitrile, Nylon e Neoprene. Copertura esterna di EPDM, resistente al calore, abrasione e esterno.*

### Aplicaciones

*Applications*  
*Applications*  
*Aplicazioni*

### Utilización con refrigerantes HFC-134a y CFC-12

*Used with refrigerants HFC-134a and CFC-12*  
*Utilisation avec réfrigérants HFC-134a et CFC-12*  
*Utilizzo con refrigeranti HFC-134a e CFC-12*

### Temperatura de trabajo

*Working temperature*  
*Température de travail*  
*Temperatura di lavoro*

**-30 / 95 °C**

DN		5/16" (8 mm)	13/32" (10 mm)	1/2" (13 mm)	5/8" (16 mm)
<b>Diámetro interior</b> <i>Inner diameter</i> Diamètre intérieur <i>Diametro interno</i>	(in) (mm)	0.322 8.2	0.418 10.6	0.512 13	0.637 16.2
<b>Diámetro exterior</b> <i>Outer diameter</i> Diamètre extérieur <i>Diametro esterno</i>	(in) (mm)	0.750 19.1	0.910 23,1	1 25.4	1.130 28.7
<b>Presión de rotura</b> <i>Burst pressure</i> Pression de rupture <i>Pressione di rottura</i>	(psi) (bar)	2000 140	2000 140	2000 140	1750 122

### Prensa manual

*Manual crimping machine*  
*Presse manuelle*  
*Pressa manuale*

#### Prensa Freón. Ref. V001040 (sin juegos de mordazas)

*Air conditioning hose crimping machine (without clamps)*  
*Presse Freon. Ref. V001040 (sans mors)*  
*Pressa Freon Rif. V001040 (senza serie di morsetti)*



### Prensas eléctricas

*Electric crimping machine*  
*Presse électrique*  
*Pressa elettrica*



**Disponemos de garras de freón para las prensas SE 25 - PE 25 / 28 / 32 / 38 / 50 / 58 / 4-50 - PE 180 - PES 50...**

*We have air conditioning clamps for the following machines SE 25 - PE 25 / 28 / 32 / 38 / 50 / 58 / 4-50 - PE 180 - PES 50...*

*Nous avons des mors de freon pour les presses SE 25 - PE 25 / 28 / 32 / 38 / 50 / 58 / 4-50 - PE 180 - PES 50...*

*Disponiamo di morsetti da Freon per le presse SE25 - PE 25 / 28 / 32 / 38 / 50 / 58 / 4-50 - PE 180 - PES 50...*

# Racores aire acondicionado

Air conditioning fittings  
Raccords climatisation  
Raccordi aria condizionata

## Freón Barrier N

Air conditioning Barrier N hose

Tuyau Freon Barrier N (polyvalent) Freon 134, 12, 14...



Freon Barrier N

DN	Ø INNER Ø INT.	Part n° Referencia	€
5/16"	7,9	M520006	12,70
13/32"	10,3	M520008	14,94
1/2"	12,7	M520010	17,02
5/8"	15,9	M520012	18,68

## Hembra recta con junta Rotalock

Straight female with Rotalock joint

Femelle climatisation droite Rotalock avec raccord tube "o" compresseur



Femmina diritta con guarnizione Rotalock

DN	THREAD ROSCA	Part n° Referencia	€
13/32"	1" 14h UNS	FXR 1108	12,15
1/2"	1" 14h UNS	FXR 1110	12,59
5/8"	1" 14h UNS	FXR 1112	18,09

## Hembra recta con junta Rotalock y válvula 134

Straight female with Rotalock joint and 134 valve

Femelle droite Rotalock avec joint et vanne pour 134



Femmina diritta con guarnizione Rotalock e valvola 134

DN	THREAD ROSCA	Part n° Referencia	€
13/32"	1" 14h UNS	134 FXRV 1108	22,14
1/2"	1" 14h UNS	134 FXRV 1110	22,72
5/8"	1" 14h UNS	134 FXRV 1112	25,03

## Hembra 45° con junta Rotalock y válvula 134

45° Female with Rotalock joint and 134 valve

Femelle 45° Rotalock avec joint et vanne pour 134



Femmina a 45° con guarnizione Rotalock e valvola 134

DN	THREAD ROSCA	Part n° Referencia	€
13/32"	1" 14h UNS	134 FX45V 1108	24,74
1/2"	1" 14h UNS	134 FX45V 1110	23,73

## Hembra 90° con junta Rotalock

90° Female with Rotalock joint

Femelle climatisation 90° Rotalock avec raccord tube 90° "o" compresseur



Femmina a 90° con guarnizione Rotalock

DN	THREAD ROSCA	Part n° Referencia	€
13/32"	1" 14h UNS	FX90 1108	13,60
1/2"	1" 14h UNS	FX90 1110	14,47
5/8"	1" 14h UNS	FX90 1112	20,69

## Hembra 45° con junta Rotalock

45° Female with Rotalock joint

Femelle climatisation 45° Rotalock avec raccord tube 45° "o" compresseur



Femmina a 45° con guarnizione Rotalock

DN	THREAD ROSCA	Part n° Referencia	€
13/32"	1" 14h UNS	FX45 1108	13,46
1/2"	1" 14h UNS	FX45 1110	14,47
5/8"	1" 14h UNS	FX45 1112	20,55

## Hembra especial 90° con junta Rotalock

90° Special female with Rotalock joint

Femelle climatisation spéciale 90° rotalock avec raccord tube 90° spécial "o" compresseur



Femmina a 90° speciale con guarnizione Rotalock

DN	THREAD ROSCA	Part n° Referencia	€
13/32"	1" 14h UNS	FXA90 1108	21,27
1/2"	1" 14h UNS	FXA90 1110	21,56

## Hembra 90° con junta Rotalock y válvula 134

90° Female with Rotalock joint and 134 valve

Femelle 90° Rotalock avec joint et vanne pour 134



Femmina a 90° con guarnizione Rotalock e valvola 134

DN	THREAD ROSCA	Part n° Referencia	€
13/32"	1" 14h UNS	134 FX90V 1108	23,30
1/2"	1" 14h UNS	134 FX90V 1110	23,87
5/8"	1" 14h UNS	134 FX90V 1112	27,64

## Hembra especial 90° con junta Rotalock y válvula 134

90° special Female with Rotalock joint and 134 valve

Femelle climatisation spéciale 90° Rotalock avec joint et vanne pour 134



Femmina a 90° speciale con guarnizione Rotalock e valvola 134

DN	THREAD ROSCA	Part n° Referencia	€
13/32"	1" 14h UNS	134 FXAV90 1108	28,36
1/2"	1" 14h UNS	134 FXAV90 1110	28,65

# Racores aire acondicionado

Air conditioning fittings  
Raccords climatisation  
Raccordi aria condizionata

## Racor de unión con válvula 134

134 valve coupling

Raccord d'union climatisation avec vanne pour splicer vanne pour 134

Raccordo di unione tubi con valvola 134



DN	Part n° Referencia	€
5/16"	134 URTV 0006	22,43
13/32"	134 URTV 0008	23,87
1/2"	134 URTV 0010	24,02
5/8"	134 URTV 0012	24,31

## Racor de unión

Hose-hose coupling

Raccord d'union climatisation splicer

Raccordo di unione tubo-tubo



DN	Part n° Referencia	€
5/16"	URT 0006	10,27
13/32"	URT 0008	10,56
1/2"	URT 0010	12,01
5/8"	URT 0012	12,59

## Hembra giratoria recta con junta verde

Straight swivel female with green joint

Femelle tournante avec joint vert

Femmina diritta con o'ring verde



DN	THREAD ROSCA	Part n° Referencia	€
5/16"	5/8" 18h UNF	FOR 0606	8,54
13/32"	3/4" 16h UNF	FOR 0808	9,12
1/2"	7/8" 14h UNF	FOR 1010	10,42
5/8"	7/8" 14h UNF	FOR 1012	11,58
5/8"	1"1/16 12h UNF	FOR 1212	13,75

## Hembra giratoria 90° con junta verde

90° swivel female with green joint

Femelle tournante 90° avec joint vert

Femmina a 90° con o'ring verde



DN	THREAD ROSCA	Part n° Referencia	€
5/16"	5/8" 18h UNF	FO90 0606	9,69
13/32"	3/4" 16h UNF	FO90 0808	10,27
1/2"	7/8" 14h UNF	FO90 1010	11,14
5/8"	7/8" 14h UNF	FO90 1012	12,15
5/8"	1"1/16 12h UNF	FO90 1212	14,76

## Hembra giratoria 45° con junta verde

45° swivel female with green joint

Femelle tournante 45° avec joint vert

Femmina a 45° con o'ring verde



DN	THREAD ROSCA	Part n° Referencia	€
5/16"	5/8" 18h UNF	FO45 0606	9,41
13/32"	3/4" 16h UNF	FO45 0808	10,27
1/2"	7/8" 14h UNF	FO45 1010	11,14
5/8"	7/8" 14h UNF	FO45 1012	12,15
5/8"	1"1/16 12h UNF	FO45 1212	14,76

## Hembra giratoria recta con válvula

Straight swivel female with green joint and valve

Femelle tournante avec joint vert et vanne pour 134

Femmina diritta con o'ring verde e valvola 134



DN	THREAD ROSCA	Part n° Referencia	€
5/16"	5/8" 18h UNF	FORV 0606	18,52
13/32"	3/4" 16h UNF	FORV 0808	19,10
1/2"	7/8" 14h UNF	FORV 1010	19,68
5/8"	7/8" 14h UNF	FORV 1012	20,84
5/8"	1"1/16 12h UNF	FORV 1212	23,59

## Hembra giratoria 90° con válvula

90° Swivel female with green joint and valve

Femelle tournante 90° avec joint vert et vanne pour 134

Femmina a 90° con o'ring verde e valvola 134



DN	THREAD ROSCA	Part n° Referencia	€
5/16"	5/8" 18h UNF	FO90V 0606	20,55
13/32"	3/4" 16h UNF	FO90V 0808	21,41
1/2"	7/8" 14h UNF	FO90V 1010	21,56
5/8"	7/8" 14h UNF	FO90V 1012	21,56
5/8"	1"1/16 12h UNF	FO90V 1212	26,04

# Racores aire acondicionado

Air conditioning fittings  
Raccords climatisation  
Raccordi aria condizionata

## Hembra giratoria 45° con válvula

45° Swivel female with green joint and valve

Femelle tournante 45° avec joint vert et vanne pour 134

Femmina a 45° con o'ring verde e valvola 134



DN	THREAD ROSCA	Part n° Referencia	€
5/16"	5/8" 18h UNF	FO45V 0606	19,53
13/32"	3/4" 16h UNF	FO45V 0808	20,40
1/2"	7/8" 14h UNF	FO45V 1010	20,84
5/8"	7/8" 14h UNF	FO45V 1012	21,56
5/8"	1"1/16 12h UNF	FO45V 1212	25,90

## Macho recto con junta tórica

Straight male with green joint

Mâle tournant avec joint vert

Maschio diritto con o'ring



DN	THREAD ROSCA	Part n° Referencia	€
5/16"	5/8" 18h UNF	MOR 0606	8,54
13/32"	3/4" 18h UNF	MOR 0808	9,12
1/2"	7/8" 18h UNF	MOR 1010	10,85
5/8"	7/8" 18h UNF	MOR 1012	12,50
5/8"	1"1/16 16h UNF	MOR 1212	14,04

## Macho 45° con junta tórica

45° Male with green joint

Mâle tournant 45° avec joint vert

Maschio a 45° con o'ring



DN	THREAD ROSCA	Part n° Referencia	€
5/16"	5/8" 18h UNF	MO45 0606	9,69
13/32"	3/4" 18h UNF	MO45 0808	10,27
1/2"	7/8" 18h UNF	MO45 1010	11,58
5/8"	7/8" 18h UNF	MO45 1012	13,31
5/8"	1"1/16 16h UNF	MO45 1212	15,19

## Hembra giratoria recta SAE

Straight swivel female SAE

Femelle tournante SAE droite

Femmina diritta SAE



DN	THREAD ROSCA	Part n° Referencia	€
5/16"	5/8" 18h UNF	FSR 0606	11,29
13/32"	3/4" 16h UNF	FSR 0808	12,30
1/2"	7/8" 14h UNF	FSR 1010	13,75

## Macho 90° con junta tórica

90° Male with green joint

Mâle tournant 90° avec joint vert

Maschio a 90° con o'ring



DN	THREAD ROSCA	Part n° Referencia	€
5/16"	5/8" 18h UNF	MO90 0606	9,69
13/32"	3/4" 18h UNF	MO90 0808	10,42
1/2"	7/8" 18h UNF	MO90 1010	11,86
5/8"	7/8" 18h UNF	MO90 1012	13,31
5/8"	1"1/16 16h UNF	MO90 1212	15,34

## Codo 90° hembra giratoria SAE

90° Swivel female SAE

Femelle tournante 90° SAE

Femmina a 90° SAE



DN	THREAD ROSCA	Part n° Referencia	€
5/16"	5/8" 18h UNF	FS90 0606	12,30
13/32"	3/4" 16h UNF	FS90 0808	13,60
1/2"	7/8" 14h UNF	FS90 1010	14,61

# Racores aire acondicionado

Air conditioning fittings  
Raccords climatisation  
Raccordi aria condizionata

## Codo 45° hembra giratoria SAE

45° Swivel female SAE

Femelle tournante 45° SAE

Femmina a 45° SAE



DN	THREAD ROSCA	Part n° Referencia	€
5/16"	5/8" 18h UNF	FS45 0606	12,15
13/32"	3/4" 16h UNF	FS45 0808	13,60
1/2"	7/8" 14h UNF	FS45 1010	14,47

## Hembra recta con junta Rotalock y válvula

Straight female with Rotalock joint and valve

Femelle droite Rotalock avec joint et vanne pour R12

Femmina diritta con guarnizione Rotalock e valvola



DN	THREAD ROSCA	Part n° Referencia	€
13/32"	1" 14h UNS	FXRV 1108	19,10
1/2"	1" 14h UNS	FXRV 1110	21,15

## Hembra especial 90° con junta Rotalock y válvula

90° Special female with Rotalock joint and valve

Femelle spéciale 90° Rotalock avec joint et vanne pour R12

Femmina a 90° speciale con guarnizione Rotalock e valvola



DN	THREAD ROSCA	Part n° Referencia	€
13/32"	1" 14h UNS	FXAV90 1108	27,49
1/2"	1" 14h UNS	FXAV90 1110	27,78

## Junta tórica para racores Freón 134

Joints for air conditioning 134 fittings

Joint torique spécial pour Freon 134

O'ring per raccordi per Freon 134



DN	Part n° Referencia	€
5/16	7.65X1.78 FREON	0,74
13/32	10.82X1.78 FREON	0,84
1/2	14X1.78 FREON	1,05
5/8	18.77X1.78 FREON	1,31

## Racor de unión con válvula

Union fitting with valve

Raccord union avec vanne pour R14 splicer vanne pour R12

Raccordi de unione con valvola



DN	Part n° Referencia	€
5/16"	URTV 0006	16,78
13/32"	URTV 0008	17,22
1/2"	URTV 0010	17,80

## Hembra 90° con junta Rotalock y válvula

90° Female with Rotalock joint and valve

Femelle 90° Rotalock avec joint et vanne pour R12

Femmina a 90° con guarnizione Rotalock e valvola



DN	THREAD ROSCA	Part n° Referencia	€
13/32"	1" 14h UNS	FX90V 1108	20,98
1/2"	1" 14h UNS	FX90V 1110	21,99

## Racores recuperables cargadoras

Reusable fittings for loaders

Raccords climatisation récupérables pour chargeurs

Raccordi recuperabili per carico



DN	THREAD ROSCA	DESCRIPCIÓN DESCRIPCIÓN	Part n° Referencia	€
3/16"	7/16"	90° Swivel female	CRFC900703	14,70
3/16"	7/16"	Ferrule	CRFM003	4,46
3/16"	7/16"	Swivel female	CRFTL0703	6,04

Para manguera Barrier / For Barrier hose / Pour tuyau Barrier / Per tubi Barrier







**Tubería rígida**

*Pipe*  
Tube rigide  
Tubo rigido

1

**Racores DIN 2353**

*DIN 2353 Pipe Fittings*  
Raccords à bague DIN 2353  
*Raccordi ad anello DIN 2353*

2

**Racores para tubo gas**

*Gas tube fittings*  
Raccords tube gaz  
*Raccordi per tubo gas*

3

**Racores JIC 37°**

*JIC 37° fittings*  
Raccords JIC 37°  
*Raccordi JIC 37°*

4

**Bridas SAE**

*SAE Flanges*  
Brides de fixation SAE  
*Flangia SAE*

5

**Abrazaderas**

*Clamps*  
Colliers  
*Collari fissatubo*

6

**Máquinas para procesar el tubo rígido**

*Machines for processing rigid pipes*  
Machines pour travailler le tube rigide  
*Macchine per il trattamento del tubo rigido*

7

## Tubería rígida

*Pipe*

Tube rigide

*Tubo rigido*

### **Tubo rígido EN 10305-4 (métrico) TrΔle**

*Pipe EN 10305-4 (Metric) TrΔle*

Tube rigide EN 10305-4 (Métrique) TrΔle

*Tubo rigido EN 10305-4 (metrico) TrΔle*

173

1

# Tubo rígido EN 10305-4 (métrico) TrΔle

Pipe EN 10305-4 (Metric) TrΔle

Tube rigide EN 10305-4 (Métrique) TrΔle

Tubo rigido EN 10305-4 (metrico) TrΔle

DIN 2353 Pipe Fittings

Gas tube fittings

JIC 37° fittings

SAE Flanges

Clamps

Machines for processing rigid pipes

■ **Tubo rígido EN 10305-4 (métrico)** / *Pipe EN 10305-4 (Metric)* / *Tube rigide EN 10305-4 (Métrique)* / *Tubo rigido EN 10305-4 (metrico)*

| 173



TH0



THZ



TH0\_3



THZ\_3

# Tubo rígido EN 10305-4 (métrico) TrΔle

Pipe EN 10305-4 (Metric) TrΔle

Tube rigide EN 10305-4 (Métrique) TrΔle

Tubo rígido EN 10305-4 (metrico) TrΔle

Pipe

DIN 2353 Pipe Fittings

Gas tube fittings

JIC 37° fittings

SAE Flanges

Clamps

Machines for processing rigid pipes

## Tubo rígido E235 (standard) - 6 mts

Pipe E235 (standard) - 6 mts

Tube rigide E235 (standard) - 6 mts

Tubo rígido E235 (standard) - 6 mts



Ø OUTER Ø EXT.	Ø INNER Ø INT.	WP (bar) PRESIÓN TRABAJO (bar)	KG/M	Part nº Referencia	€/m
6	4	325	0,123	TH0060100	<b>3,69</b>
8	6	225	0,173	TH0080100	<b>4,34</b>
8	5	375	0,240	TH0080150	<b>4,59</b>
10	7	275	0,314	TH0100150	<b>5,15</b>
12	9	225	0,388	TH0120150	<b>5,75</b>
14	10	275	0,592	TH0140200	<b>8,23</b>
15	12	175	0,499	TH0150150	<b>6,76</b>
16	12	225	0,690	TH0160200	<b>8,93</b>
18	14	200	0,789	TH0180200	<b>9,14</b>
20	14	275	1,258	TH0200300	<b>14,08</b>
22	18	150	0,986	TH0220200	<b>11,46</b>
25	19	225	1,628	TH0250300	<b>17,31</b>
28	24	125	1,282	TH0280200	<b>15,14</b>
30	24	175	1,997	TH0300300	<b>20,65</b>
35	29	150	2,367	TH0350300	<b>24,89</b>
42	36	125	2,885	TH0420300	<b>30,34</b>

## Tubo rígido E235 (standard) - 3 mts

Pipe E235 (standard) - 3 mts

Tube rigide E235 (standard) - 3 mts

Tubo rígido E235 (standard) - 3 mts



Ø OUTER Ø EXT.	Ø INNER Ø INT.	WP (bar) PRESIÓN TRABAJO (bar)	KG/M	Part nº Referencia	€/m
6	4	325	0,123	TH0060100-3	<b>3,87</b>
8	6	225	0,172	TH0080100-3	<b>4,56</b>
8	5	375	0,24	TH0080150-3	<b>4,82</b>
10	7	275	0,314	TH0100150-3	<b>5,41</b>
12	9	225	0,388	TH0120150-3	<b>6,04</b>
14	10	275	0,591	TH0140200-3	<b>8,64</b>
15	12	175	0,499	TH0150150-3	<b>7,10</b>
16	12	225	0,69	TH0160200-3	<b>9,38</b>
18	14	200	0,789	TH0180200-3	<b>9,59</b>
20	14	275	1,257	TH0200300-3	<b>14,79</b>
22	18	150	0,986	TH0220200-3	<b>12,03</b>
25	19	225	1,627	TH0250300-3	<b>18,18</b>
28	24	125	1,282	TH0280200-3	<b>15,90</b>
30	24	175	1,997	TH0300300-3	<b>21,68</b>
35	29	150	2,367	TH0350300-3	<b>26,13</b>
42	36	125	2,885	TH0420300-3	<b>31,85</b>

## Tubo rígido E235 (Cromo III) - 6 mts

Pipe E235 (Chrome III) - 6 mts

Tube rigide E235 (Chrome III) - 6 mts

Tubo rígido E235 (Cromo III) - 6 mts



Ø OUTER Ø EXT.	Ø INNER Ø INT.	WP (bar) PRESIÓN TRABAJO (bar)	KG/M	Part nº Referencia	€/m
6	4	325	0,123	THZ060100	<b>4,66</b>
8	6	225	0,173	THZ080100	<b>5,45</b>
8	5	375	0,240	THZ080150	<b>5,66</b>
10	7	275	0,314	THZ100150	<b>6,51</b>
12	9	225	0,388	THZ120150	<b>7,20</b>
14	10	275	0,592	THZ140200	<b>9,95</b>
15	12	175	0,499	THZ150150	<b>8,63</b>
15	11	250	0,641	THZ150200	<b>11,45</b>
16	12	225	0,690	THZ160200	<b>11,00</b>
18	15	150	0,610	THZ180150	<b>10,15</b>
18	14	200	0,789	THZ180200	<b>11,32</b>
20	14	275	1,258	THZ200300	<b>16,56</b>
22	18	150	0,986	THZ220200	<b>14,07</b>
25	19	225	1,628	THZ250300	<b>20,90</b>
28	24	125	1,282	THZ280200	<b>19,00</b>
30	22	250	2,565	THZ300400	<b>32,01</b>
35	29	150	2,367	THZ350300	<b>30,14</b>
42	36	125	2,885	THZ420300	<b>37,00</b>
38	30	225	3,354	THZ380400	<b>41,77</b>

## Tubo rígido E235 (Cromo III) - 3 mts

Pipe E235 (Chrome III) - 3 mts

Tube rigide E235 (Chrome III) - 3 mts

Tubo rígido E235 (Cromo III) - 3 mts



Ø OUTER Ø EXT.	Ø INNER Ø INT.	WP (bar) PRESIÓN TRABAJO (bar)	KG/M	Part nº Referencia	€/m
6	4	325	0,123	THZ060100-3	<b>4,89</b>
8	6	225	0,172	THZ080100-3	<b>5,72</b>
8	5	375	0,240	THZ080150-3	<b>5,95</b>
10	7	275	0,314	THZ100150-3	<b>6,84</b>
12	9	225	0,388	THZ120150-3	<b>7,56</b>
14	10	275	0,591	THZ140200-3	<b>10,44</b>
15	12	175	0,499	THZ150150-3	<b>9,06</b>
15	11	250	0,641	THZ150200-3	<b>12,02</b>
16	12	225	0,690	THZ160200-3	<b>11,55</b>
18	15	150	0,610	THZ180150-3	<b>10,66</b>
18	14	200	0,789	THZ180200-3	<b>11,89</b>
20	14	275	1,257	THZ200300-3	<b>17,39</b>
22	18	150	0,986	THZ220200-3	<b>14,78</b>
25	19	225	1,627	THZ250300-3	<b>21,95</b>
28	24	125	1,282	THZ280200-3	<b>19,95</b>
30	22	250	2,564	THZ300400-3	<b>33,61</b>
35	29	150	2,367	THZ350300-3	<b>31,64</b>
38	30	225	3,354	THZ380400-3	<b>43,86</b>
42	36	125	2,885	THZ420300-3	<b>38,85</b>

## Racores DIN 2353

*DIN 2353 Pipe Fittings*

Raccords à bague DIN 2353

*Raccordi ad anello DIN 2353*

## Racores DIN 2353

*DIN 2353 Pipe fittings*

Raccords à bague DIN 2353

*Raccordi ad anello DIN 2353*

180

2

# Racores DIN 2353

DIN 2353 Pipe fittings  
Raccords à bague DIN 2353  
Raccordi DIN 2353

**Instrucciones de montaje del racor DIN 2353 sobre el tubo rígido (se recomienda el uso de herramientas de premontaje)**

Assembly of the pipe fittings DIN 2353 in the rigid pipe (It is recommended to use pre-assembly tools)  
Mode d'emploi de montage du raccord DIN 2353 sur le tube rigide (l'utilisation des outils de pré-montage est conseillée)  
Assemblaggio del raccordo ad anello DIN 2353 nel tubo rigido (è si consiglia l'uso degli utensili di premontaggio)

**A. Preparación del tubo**

Preparation of the tube  
Préparation du tube  
Preparazione del tubo

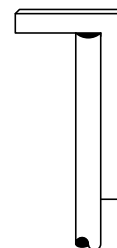
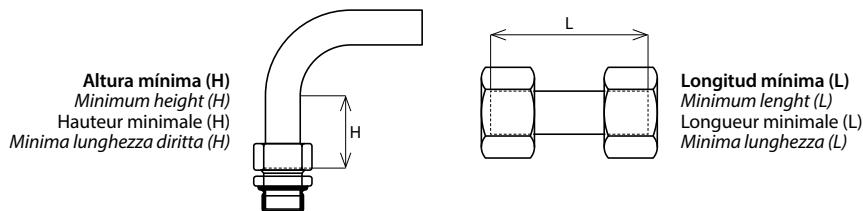

**Cortar el tubo a escuadra y eliminar rebabas.**  
Rectangulary saw off the pipe and slightly debug the tube ends inside and outside.  
Couper le tube à angle droit sans coupes imprécises.  
Tagliare il tubo ad angolo retto ed eliminare i residui metallici.

	Series / Series / Série / Serie		
	LL	L	S
<b>Ø exterior</b> Ø outer Ø extérieur Ø esterno	4-5-6-8	6-8-10-12-15-18-22-28-35-42	6-8-10-12-14-16-20-25-30-38
<b>H mínimo</b> H minimum H minimum H minimo	24-25-25-26	31-31-33-33-36-38-42-42-48-48	35-35-37-37-43-43-50-54-58-65
<b>L mínimo</b> L minimum L minimum L minimo	30-32-32-33	39-39-42-42-45-48-53-53-60-60	44-44-47-47-54-54-63-68-73-82

**B. Lubricar adecuadamente**

Lubricate suitably  
Lubrifier convenablement  
Lubrificare convenientemente

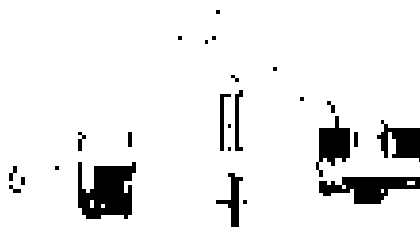

**C. Montaje**

Assembly  
Montage  
Montaggio



**D. Apriete**

Blocking  
Blockage  
Bloccaggio

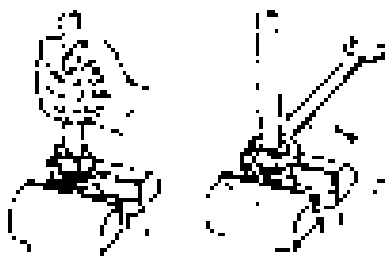

**E. Control**

Control  
Control  
Controllo

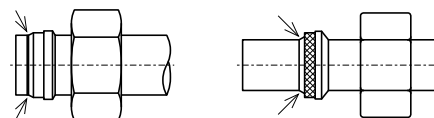

**F. Montaje final**

Final assembly  
Montage final  
Montaggio finale

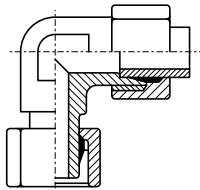

**G. Montajes posteriores**

Later assemblies  
Montages posterieurs  
Montaggio successivo

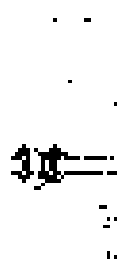

**Nota sobre piezas premontadas (CTA):** El montaje final se realizará apretando la tuerca al menos ½ vuelta más desde el punto a partir del cual se empieza a hacer más fuerza.  
For preassembled fittings (CTA), the final assembly is made tightening the nut at least ½ turn beyond the point of a noticeable increase in force.  
Pour les pièces pré-assemblées (CTA), le montage final doit être fait en tournant au moins un ½ tour à partir du point où une résistance plus importante est appréciée.  
Per tutti i raccordi premontati (CTA), il premontaggio avviene con apposite attrezzature. Il montaggio finale si realizza serrando almeno ½ giro oltre il punto in cui si inizia ad avvertire chiaramente l'aumento della resistenza.



# Una solución eficaz, económica y sencilla para prevenir el goteo en las conducciones de tubo rígido

*An effective, cheap and simple solution to prevent the leak in pipe fittings*

*Une solution efficace, économique et simple pour prévenir les fuites dans les embouts pour tube rigide*

*Una soluzione efficace, economica e semplice per prevenire perdite dai raccordi per tubo rigido*



## ■ Óptima prevención de fugas

**Larga durabilidad**

**Fácil montaje, revisión y sustitución**

**Protección antivibraciones**

**Excelente resistencia a altas temperaturas y fluidos agresivos**

*Good leakage prevention*

*Long shelf life*

*Easy assembly, inspection, replacement*

*Anti-vibration and unscrewing protection*

*Excellent resistance to high temperatures and aggressive fluids*

*Bonne prévention de fuites*

*Longue durée*

*Facil montage, inspection et substitution*

*Protection Anti-vibration*

*Excellente resistance aux hautes temperatures et fluides agressifs*

*Buona prevenzione delle perdite*

*Lunga durata*

*Facile montaggio, ispezione e sostituzione*

*Antivibrazione e protezione allo svitamento*

*Eccellente resistenza alle alte temperature e fluidi aggressivi*

## ■ Información técnica

*Technical data*

*Information technique*

*Informazione tecnica*

Material Material Matériel Materiale	Temperatura Temperature Temperature Temperatura	Durabilidad Self life Durée Durata
<b>FKM verde</b> Green FKM 70/80 sh FKM vert 70/80 sh FKM verde	-35 °C + 100 °C	<b>5 años</b> 5 year 5 an 5 anni

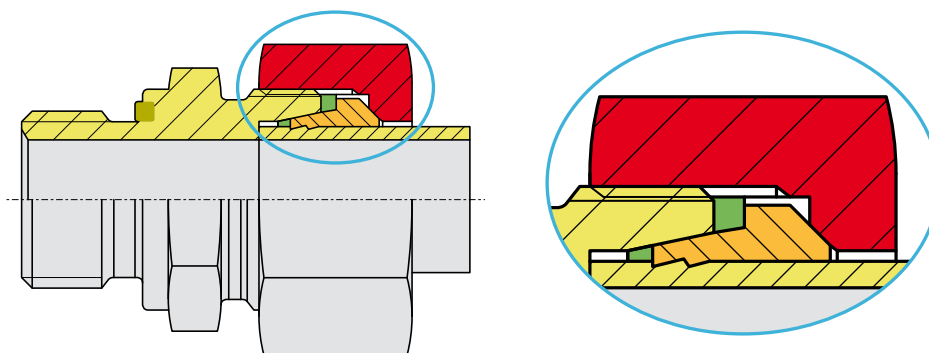

# Racores DIN 2353

DIN 2353 Pipe fittings

Raccords à bague DIN 2353

Raccordi ad anello DIN 2353

## Tuercas y anillos / Nuts and cutting rings / Écrou et bagues / Dadi e anelli

| 180

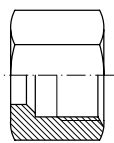

ML/MS



ACL/ACS

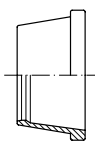

VA

## Uniones tubo-tubo / Straight couplings / Unions doubles / Raccordi intermedi

| 181

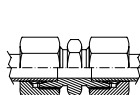

DL/DS

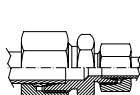

DL/DS

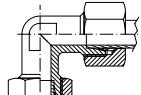

EL/ES

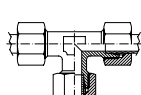

TL/TS

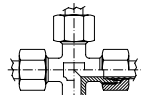

KVL/KVS

## Uniones rectas tubo-roscas / Straight male stud couplings / Unions simples mâle / Raccordi di estremità diritti

| 183

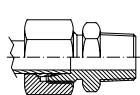

AKL/AKS BSPT

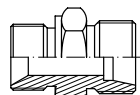

STA AL RC

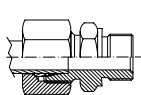

AL/AS BSP

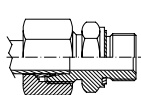

AL/AS WD BSP

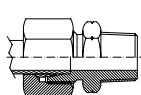

AKL/AKS NPT

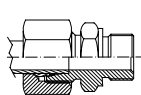

AL/AS UNF

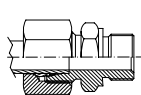

AL/AS METRICA

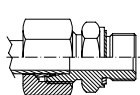

AL/AS WD METRICA

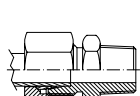

AKLL METRICA

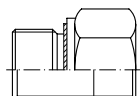

RI-R WD

## Codos tubo-roscas / Male stud elbows / Coudes mâle gaz / Raccordi di estremità a 90°

| 187

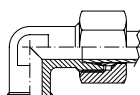

CKL/CKS BSPT

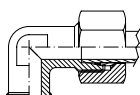

CKL/CKS METRICA

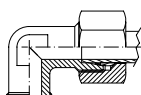

CKL/CKS NPT

## Uniones Métricas / Metric unions / Unions Métriques / Raccordi di riduzione (Metrici)

| 188

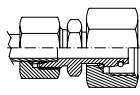

KORL-TLM

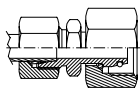

KORS-TLM

## Racores regulables / Adjustable stud couplings / Raccords réglables / Raccordi orientabili

| 189

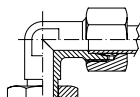

EEL/EES-CTA

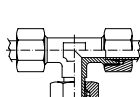

TEL/TES-CTA

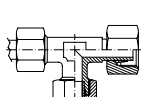

LEL/LES-CTA

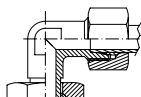

EEL/EES-TLM

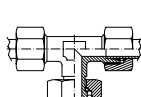

TEL/TES-TLM

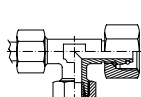

LEL/LES-TLM

## Tubo roscado (hembra giratoria) / Adjustable straight stud / Tube fileté / Raccordi di estremità per combinazioni

| 191

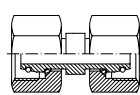

ATL/ATS

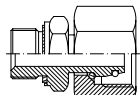

RAL/RAS-TLM METRICA

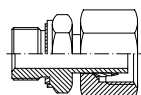

RAL/RAS-CTA METRICA

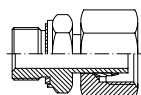

RAL/RAS-CTA BSP

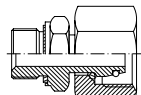

RAL/RAS-TLM BSP

# Racores DIN 2353

DIN 2353 Pipe fittings  
Raccords à bague DIN 2353  
Raccordi ad anello DIN 2353

## ■ Soldables / Welding couplings / Raccords à souder / Raccordi a saldare

193

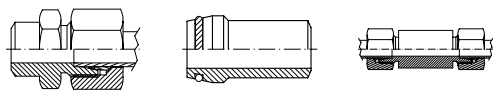

ASL/ASS

ORIS

ESVL/ESVS

## ■ Pasatabiques / Bulkhead / Passe cloison / Raccordi di attraversamento

194

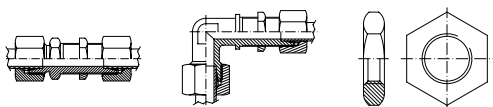

SVL/SVS

USVL/USVS

TP L/S

## ■ Racor recto hembra / Straight female coupling / Raccord droit femelle / Raccordi diritti con estremità femmina

195

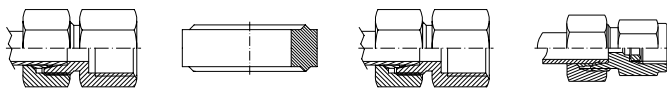

GAIL/GAIS BSP

AM

GAIL/GAIS METRICA

MAVL/MAVS BSP

## ■ Orientables / Banjos / Banjos / Raccordi orientabili a occhio

196

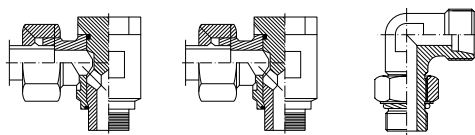

WSVL/WSVS BSP

WSVL/WSVS METRICA

STA WEE

## ■ Tapones / Plugs / Bouchons / Tappi

197

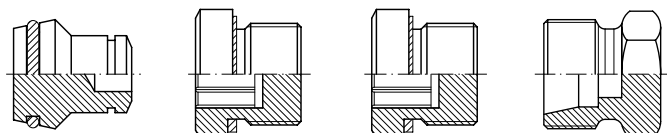

BUTZEN L/S

STOPFEN BSP

STOPFEN METRICA

STA TML/TMS

## ■ Válvulas antirretorno / Non-return valves / Clapet antiretour pour tube / Valvole di ritegno

198

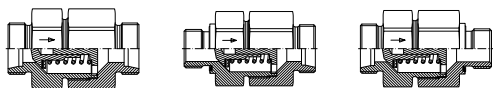

RHDL/RHDS BIDIRECCIONAL

RHVL/RHVS &lt;=&gt;

RHZL/RHZS =&gt;

# Racores DIN 2353

DIN 2353 Pipe fittings

Raccords à bague DIN 2353

Raccordi ad anello DIN 2353

## Tuerca Métrica DIN 3870

Nuts DIN 3870

Écrou Métrique DIN 3870

Dadi Metrici DIN 3870

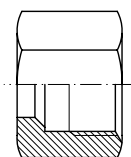

PIPE TUBO	SERIE	THREAD ROSCA	Part nº Referencia	€
4	LL	M8x1	MLL 4 M 8X1	0,32
6	LL	M10x1	MLL 6 M 10X1	0,33
8	LL	M12x1	MLL 8 M 12X1	0,38
6	L	M12x1,5	ML 6 M 12X1.5	0,31
8	L	M14x1,5	ML 8 M 14X1.5	0,29
10	L	M16x1,5	ML 10 M 16X1.5	0,35
12	L	M18x1,5	ML 12 M 18X1.5	0,42
15	L	M22x1,5	ML 15 M 22X1.5	0,75
18	L	M26x1,5	ML 18 M 26X1.5	1,04
22	L	M30x2	ML 22 M 30X2	1,47
28	L	M36x2	ML 28 M 36X2	2,46
35	L	M45x2	ML 35 M 45X2	4,28
42	L	M52x2	ML 42 M 52X2	5,89
6	S	M14x1,5	MS 6 M 14X1.5	0,35
8	S	M16x1,5	MS 8 M 16X1.5	0,39
10	S	M18x1,5	MS 10 M 18X1.5	0,50
12	S	M20x1,5	MS 12 M 20X1.5	0,58
14	S	M22x1,5	MS 14 M 22X1.5	1,02
16	S	M24x1,5	MS 16 M 24X1.5	1,18
20	S	M30x2	MS 20 M 30X2	1,64
25	S	M36x2	MS 25 M 36X2	3,43
30	S	M42x2	MS 30 M 42X2	5,30
38	S	M52x2	MS 38 M 52X2	6,96

## Anillos de corte DIN 3861

Cutting rings DIN 3861

Bague Métrique DIN 3861

Anelli DIN 3861



PIPE TUBO	SERIE	Part nº Referencia	€
4	LL	ACLL 4	0,21
6	LL	ACLL 6	0,22
8	LL	ACLL 8	0,27
6	L/S	ACL 6	0,31
8	L/S	ACL 8	0,30
10	L/S	ACL 10	0,39
12	L/S	ACL 12	0,42
15	L	ACL 15	0,44
18	L	ACL 18	0,64
22	L	ACL 22	0,79
28	L	ACL 28	0,92
35	L	ACL 35	0,98
42	L	ACL 42	1,84
14	S	ACS 14	0,54
16	S	ACS 16	0,64
20	S	ACS 20	0,72
25	S	ACS 25	0,92
30	S	ACS 30	1,12
38	S	ACS 38	1,44

## Anillo FKM antifuga

FKM seal non-leak

Joint FKM anti-fouet

Anello FKM anti-fuga

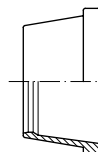

PIPE TUBO	SERIE	Part nº Referencia	€
6	L/S	VA006L	1,16
8	L/S	VA008L	1,23
10	L/S	VA010L	1,28
12	L/S	VA012L	1,39
15	L	VA015L	1,81
18	L	VA018L	1,87
22	L	VA022L	2,09
28	L	VA028L	2,88
35	L	VA035L	4,55
42	L	VA042L	5,48
14	S	VA014S	1,51
16	S	VA016S	1,83
20	S	VA020S	2,02
25	S	VA025S	2,73
30	S	VA030S	4,17
38	S	VA038S	5,39

# Racores DIN 2353

DIN 2353 Pipe fittings  
Raccords à bague DIN 2353  
Raccordi ad anello DIN 2353

## Unión recta tubo-tubo

Straight coupling (pipe-pipe)

Union droite (tuyau-tuyau)

Raccordo intermedio diritto (tubo-tubo)

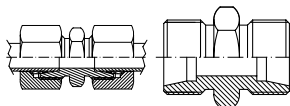

PIPE TUBO	SERIE	Part nº Referencia	€	Part Nº STA Referencia STA	€
4	LL	DLL 4	2,09	STA DLL 4	0,97
6	LL	DLL 6	2,10	STA DLL 6	0,93
8	LL	DLL 8	2,31	STA DLL 8	0,94
6	L	DL 6	1,95	STA DL 6	0,65
8	L	DL 8	2,06	STA DL 8	0,82
10	L	DL 10	2,45	STA DL 10	0,90
12	L	DL 12	2,73	STA DL 12	0,97
15	L	DL 15	3,81	STA DL 15	1,32
18	L	DL 18	5,19	STA DL 18	1,67
22	L	DL 22	7,53	STA DL 22	2,79
28	L	DL 28	12,37	STA DL 28	5,25
35	L	DL 35	18,63	STA DL 35	7,57
42	L	DL 42	27,91	STA DL 42	11,64
6	S	DS 6	2,45	STA DS 6	1,05
8	S	DS 8	2,53	STA DS 8	1,08
10	S	DS 10	3,04	STA DS 10	1,17
12	S	DS 12	3,73	STA DS 12	1,62
14	S	DS 14	5,38	STA DS 14	2,10
16	S	DS 16	5,97	STA DS 16	2,16
20	S	DS 20	8,38	STA DS 20	3,42
25	S	DS 25	15,44	STA DS 25	6,30
30	S	DS 30	22,50	STA DS 30	9,00
38	S	DS 38	32,14	STA DS 38	14,40

## Unión recta en reducción tubo-tubo

Straight reducing coupling (pipe-pipe)

Union double en réduction (tuyau-tuyau)

Raccordo intermedio di riduzione (tubo-tubo)

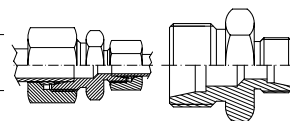

PIPE TUBO	SERIE	Part nº Referencia	€	Part Nº STA Referencia STA	€
8	6	L DL 8-6	2,33	STA DL 8-6	1,05
10	6	L DL 10-6	2,59	STA DL 10-6	1,15
10	8	L DL 10-8	2,57	STA DL 10-8	1,15
12	8	L DL 12-8	2,76	STA DL 12-8	1,25
12	10	L DL 12-10	2,93	STA DL 12-10	1,26
15	10	L DL 15-10	4,00	STA DL 15-10	1,95
15	12	L DL 15-12	4,04	STA DL 15-12	1,89
18	12	L DL 18-12	5,01	STA DL 18-12	2,34
18	15	L DL 18-15	5,12	STA DL 18-15	2,10
22	15	L DL 22-15	7,17	STA DL 22-15	3,51
22	18	L DL 22-18	7,42	STA DL 22-18	3,25
28	22	L DL 28-22	11,22	STA DL 28-22	5,25
35	22	L DL 35-22	28,94	STA DL 35-22	20,58
35	28	L DL 35-28	29,16	STA DL 35-28	19,66
8	6	S DS 8-6	2,84	STA DS 8-6	1,40
10	6	S DS 10-6	3,20	STA DS 10-6	1,56
10	8	S DS 10-8	3,23	STA DS 10-8	1,56
12	6	S DS 12-6	3,72	STA DS 12-6	1,95
12	8	S DS 12-8	4,23	STA DS 12-8	2,42
12	10	S DS 12-10	4,44	STA DS 12-10	2,42
14	10	S DS 14-10	4,77	STA DS 14-10	2,18
14	12	S DS 14-12	4,88	STA DS 14-12	2,18
16	12	S DS 16-12	5,32	STA DS 16-12	2,34
16	14	S DS 16-14	6,08	STA DS 16-14	2,52
20	12	S DS 20-12	7,48	STA DS 20-12	3,90
20	16	S DS 20-16	8,41	STA DS 20-16	3,99
25	16	S DS 25-16	12,77	STA DS 25-16	6,24
25	20	S DS 25-20	14,47	STA DS 25-20	7,35
30	20	S DS 30-20	32,19	STA DS 30-20	22,48
30	25	S DS 30-25	34,61	STA DS 30-25	22,83
38	30	S DS 38-30	48,43	STA DS 38-30	32,20

# Racores DIN 2353

DIN 2353 Pipe fittings  
Raccords à bague DIN 2353  
Raccordi ad anello DIN 2353

## Unión en codo tubo-tubo

Equal elbow coupling (pipe-pipe)

Union en coude égal (tuyau-tuyau)

Raccordo intermedio a 90° (tubo-tubo)

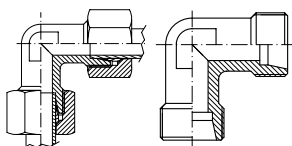

PIPE TUBO	SERIE	Part nº Referencia	€	Part nº STA Referencia STA	€
4	LL	ELL 4	3,14	STA ELL 4	1,98
6	LL	ELL 6	3,17	STA ELL 6	1,98
8	LL	ELL 8	3,70	STA ELL 8	2,29
6	L	EL 6	4,21	STA EL 6	2,86
8	L	EL 8	4,24	STA EL 8	2,94
10	L	EL 10	4,34	STA EL 10	2,73
12	L	EL 12	4,72	STA EL 12	2,90
15	L	EL 15	6,87	STA EL 15	4,29
18	L	EL 18	9,18	STA EL 18	5,55
22	L	EL 22	12,09	STA EL 22	7,22
28	L	EL 28	19,96	STA EL 28	12,62
35	L	EL 35	34,01	STA EL 35	22,50
42	L	EL 42	45,59	STA EL 42	28,81
6	S	ES 6	4,82	STA ES 6	3,35
8	S	ES 8	5,36	STA ES 8	3,82
10	S	ES 10	5,80	STA ES 10	3,85
12	S	ES 12	5,87	STA ES 12	3,70
14	S	ES 14	8,38	STA ES 14	5,02
16	S	ES 16	9,36	STA ES 16	5,46
20	S	ES 20	13,11	STA ES 20	8,01
25	S	ES 25	22,99	STA ES 25	13,63
30	S	ES 30	39,90	STA ES 30	25,90
38	S	ES 38	60,65	STA ES 38	42,08

## Unión en te tubo-tubo

Equal Tee union (tuyau-tuyau)

Union en Té égal (tuyau-tuyau)

Raccordo intermedio a T (tubo-tubo)

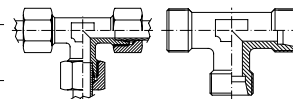

PIPE TUBO	SERIE	Part nº Referencia	€	Part nº STA Referencia STA	€
4	LL	TLL 4	4,18	STA TLL 4	2,46
6	LL	TLL 6	4,23	STA TLL 6	2,46
8	LL	TLL 8	5,06	STA TLL 8	2,97
6	L	TL 6	5,17	STA TL 6	3,17
8	L	TL 8	5,46	STA TL 8	3,52
10	L	TL 10	6,10	STA TL 10	3,70
12	L	TL 12	6,94	STA TL 12	4,23
15	L	TL 15	9,47	STA TL 15	5,62
18	L	TL 18	14,19	STA TL 18	8,73
22	L	TL 22	18,43	STA TL 22	11,10
28	L	TL 28	31,89	STA TL 28	20,81
35	L	TL 35	55,95	STA TL 35	38,54
42	L	TL 42	88,06	STA TL 42	62,31
6	S	TS 6	5,67	STA TS 6	3,51
8	S	TS 8	7,54	STA TS 8	5,25
10	S	TS 10	9,69	STA TS 10	6,74
12	S	TS 12	10,17	STA TS 12	6,87
14	S	TS 14	13,57	STA TS 14	8,49
16	S	TS 16	15,62	STA TS 16	9,71
20	S	TS 20	19,64	STA TS 20	12,00
25	S	TS 25	36,20	STA TS 25	22,12
30	S	TS 30	44,77	STA TS 30	24,21
38	S	TS 38	64,89	STA TS 38	37,81

## Unión en cruz tubo-tubo

Equal cross union (pipe-pipe)

Union en croix égale (tuyau-tuyau)

Raccordo intermedio a croce (tubo-tubo)

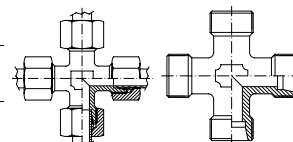

PIPE TUBO	SERIE	Part nº Referencia	€	Part nº STA Referencia STA	€
6	L	KVL 6	*	STA KVL 6	5,93
8	L	KVL 8	*	STA KVL 8	7,34
10	L	KVL 10	*	STA KVL 10	7,89
12	L	KVL 12	*	STA KVL 12	8,70
15	L	KVL 15	*	STA KVL 15	12,33
18	L	KVL 18	*	STA KVL 18	17,55
22	L	KVL 22	*	STA KVL 22	57,81
28	L	KVL 28 *	*	STA KVL 28	73,82
35	L	KVL 35 *	*	STA KVL 35	93,49
42	L	KVL 42 *	*	STA KVL 42	128,11
6	S	KVS 6 *	*	STA KVS 6	39,82
8	S	KVS 8	*	STA KVS 8	40,26
10	S	KVS 10 *	*	STA KVS 10	41,96
12	S	KVS 12	*	STA KVS 12	11,42
14	S	KVS 14 *	*	STA KVS 14	45,35
16	S	KVS 16	*	STA KVS 16	17,55
20	S	KVS 20	*	STA KVS 20	57,81
25	S	KVS 25 *	*	STA KVS 25	73,82
30	S	KVS 30	*	STA KVS 30	93,49
38	S	KVS 38	*	STA KVS 38	128,11

# Racores DIN 2353

DIN 2353 Pipe fittings  
Raccords à bague DIN 2353  
Raccordi ad anello DIN 2353

## Racor recto rosca cónica BSPT

Straight male stud coupling BSPT tapered

Union simple mâle conique

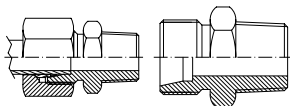

Raccordo di estremità diritto conico BSPT

PIPE TUBO	SERIE	THREAD ROSCA	Part n° Referencia	€	Part N° STA Referencia STA	€
4	LL	1/8" BSPT	AKLL 4 R 1/8	1,33	STA AKLL 4 R 1/8	0,76
6	LL	1/8" BSPT	AKLL 6 R 1/8	1,35	STA AKLL 6 R 1/8	0,76
8	LL	1/8" BSPT	AKLL 8 R 1/8	1,47	STA AKLL 8 R 1/8	0,78
8	LL	1/4" BSPT	AKLL 8 R 1/4	1,57	STA AKLL 8 R 1/4	0,87
6	L	1/8" BSPT	AKL 6 R 1/8	1,45	STA AKL 6 R 1/8	0,79
6	L	1/4" BSPT	AKL 6 R 1/4	1,75	STA AKL 6 R 1/4	1,08
8	L	1/4" BSPT	AKL 8 R 1/4	1,72	STA AKL 8 R 1/4	1,08
10	L	1/4" BSPT	AKL 10 R 1/4	1,88	STA AKL 10 R 1/4	1,08
10	L	3/8" BSPT	AKL 10 R 3/8	2,15	STA AKL 10 R 3/8	1,35
12	L	1/4" BSPT	AKL 12 R 1/4	2,26	STA AKL 12 R 1/4	1,35
12	L	3/8" BSPT	AKL 12 R 3/8	2,26	STA AKL 12 R 3/8	1,35
12	L	1/2" BSPT	AKL 12 R 1/2	2,72	STA AKL 12 R 1/2	1,80
15	L	3/8" BSPT	AKL 15 R 3/8	2,67	STA AKL 15 R 3/8	1,40
15	L	1/2" BSPT	AKL 15 R 1/2	3,08	STA AKL 15 R 1/2	1,80
18	L	1/2" BSPT	AKL 18 R 1/2	4,22	STA AKL 18 R 1/2	2,42
22	L	3/4" BSPT	AKL 22 R 3/4	5,58	STA AKL 22 R 3/4	3,15
6	S	1/4" BSPT	AKS 6 R 1/4	1,93	STA AKS 6 R 1/4	1,20
8	S	1/4" BSPT	AKS 8 R 1/4	2,09	STA AKS 8 R 1/4	1,34
10	S	3/8" BSPT	AKS 10 R 3/8	2,21	STA AKS 10 R 3/8	1,26
12	S	3/8" BSPT	AKS 12 R 3/8	2,86	STA AKS 12 R 3/8	1,79
16	S	1/2" BSPT	AKS 16 R 1/2	4,68	STA AKS 16 R 1/2	2,73
20	S	3/4" BSPT	AKS 20 R 3/4	7,53	STA AKS 20 R 3/4	4,95

## Racor recto rosca cilíndrica BSP 60°

Straight male stud coupling BSP cyl. 60°

Union simple mâle gaz cylindrique 60°

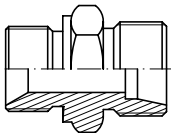

Raccordo di estremità diritto BSP 60°

PIPE TUBO	SERIE	THREAD ROSCA	Part n° Referencia	€
6	L	1/8" BSP	STA AL 6 RC 1/8	1,22
6	L	1/4" BSP	STA AL 6 RC 1/4	1,69
8	L	1/4" BSP	STA AL 8 RC 1/4	1,30
8	L	3/8" BSP	STA AL 8 RC 3/8	2,21
10	L	1/4" BSP	STA AL 10 RC 1/4	1,34
10	L	3/8" BSP	STA AL 10 RC 3/8	1,76
10	L	1/2" BSP	STA AL 10 RC 1/2	3,18
12	L	1/4" BSP	STA AL 12 RC 1/4	1,38
12	L	3/8" BSP	STA AL 12 RC 3/8	1,68
12	L	1/2" BSP	STA AL 12 RC 1/2	2,45
15	L	3/8" BSP	STA AL 15 RC 3/8	2,56
15	L	1/2" BSP	STA AL 15 RC 1/2	2,50
18	L	1/2" BSP	STA AL 18 RC 1/2	2,56
22	L	3/4" BSP	STA AL 22 RC 3/4	4,24
28	L	1" BSP	STA AL 28 RC 1	7,05
16	S	3/8" BSP	STA AS 16 RC 3/8	3,24
16	S	1/2" BSP	STA AS 16 RC 1/2	2,82
20	S	3/4" BSP	STA AS 20 RC 3/4	4,90
25	S	1" BSP	STA AS 25 RC 1	8,13

## Racor recto rosca cilíndrica BSP

Straight male stud coupling BSP cyl

Union simple mâle gaz cyl

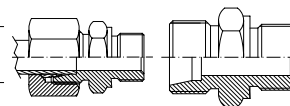

Raccordo di estremità diritto BSP

PIPE TUBO	SERIE	THREAD ROSCA	Part n° Referencia	€	Part N° STA Referencia STA	€
6	L	1/8" BSP	AL 6 R 1/8	1,31	STA AL 6 R 1/8	0,65
6	L	1/4" BSP	AL 6 R 1/4	1,39	STA AL 6 R 1/4	0,73
6	L	3/8" BSP	AL 6 R 3/8	2,53	STA AL 6 R 3/8	1,85
6	L	1/2" BSP	AL 6 R 1/2	2,43	STA AL 6 R 1/2	1,74
8	L	1/8" BSP	AL 8 R 1/8	1,64	STA AL 8 R 1/8	0,99
8	L	1/4" BSP	AL 8 R 1/4	1,62	STA AL 8 R 1/4	0,98
8	L	3/8" BSP	AL 8 R 3/8	1,70	STA AL 8 R 3/8	1,06
8	L	1/2" BSP	AL 8 R 1/2	3,42	STA AL 8 R 1/2	2,72
10	L	1/8" BSP	AL 10 R 1/8	2,14	STA AL 10 R 1/8	1,34
10	L	1/4" BSP	AL 10 R 1/4	1,61	STA AL 10 R 1/4	0,82
10	L	3/8" BSP	AL 10 R 3/8	2,19	STA AL 10 R 3/8	1,39
10	L	1/2" BSP	AL 10 R 1/2	2,36	STA AL 10 R 1/2	1,55
12	L	1/4" BSP	AL 12 R 1/4	2,16	STA AL 12 R 1/4	1,26
12	L	1/2" BSP	AL 12 R 1/2	2,88	STA AL 12 R 1/2	1,96
12	L	3/4" BSP	AL 12 R 3/4	3,68	STA AL 12 R 3/4	2,73
12	L	3/8" BSP	AL 12 R 3/8	2,30	STA AL 12 R 3/8	1,39
15	L	3/8" BSP	AL 15 R 3/8	2,82	STA AL 15 R 3/8	1,55
15	L	1/2" BSP	AL 15 R 1/2	3,24	STA AL 15 R 1/2	1,96
15	L	3/4" BSP	AL 15 R 3/4	3,64	STA AL 15 R 3/4	2,34
18	L	1/2" BSP	AL 18 R 1/2	3,50	STA AL 18 R 1/2	1,71
18	L	3/4" BSP	AL 18 R 3/4	5,32	STA AL 18 R 3/4	3,48
18	L	3/8" BSP	AL 18 R 3/8	3,45	STA AL 18 R 3/8	1,67
22	L	1/2" BSP	AL 22 R 1/2	5,27	STA AL 22 R 1/2	2,86
22	L	3/4" BSP	AL 22 R 3/4	5,27	STA AL 22 R 3/4	2,86
22	L	1" BSP	AL 22 R 1	9,89	STA AL 22 R 1	7,34
28	L	3/4" BSP	AL 28 R 3/4	10,83	STA AL 28 R 3/4	7,13
28	L	1" BSP	AL 28 R 1	9,79	STA AL 28 R 1	6,12
35	L	1" BSP	AL 35 R 1	21,84	STA AL 35 R 1	15,94
35	L	1 1/4" BSP	AL 35 R 1 1/4	15,46	STA AL 35 R 1 1/4	9,75
42	L	1 1/2" BSP	AL 42 R 1 1/2	22,99	STA AL 42 R 1 1/2	14,60
6	S	1/4" BSP	AS 6 R 1/4	2,07	STA AS 6 R 1/4	1,35
8	S	1/4" BSP	AS 8 R 1/4	2,10	STA AS 8 R 1/4	1,35
8	S	3/8" BSP	AS 8 R 3/8	2,50	STA AS 8 R 3/8	1,74
10	S	1/4" BSP	AS 10 R 1/4	2,52	STA AS 10 R 1/4	1,56
10	S	3/8" BSP	AS 10 R 3/8	2,68	STA AS 10 R 3/8	1,71
10	S	1/2" BSP	AS 10 R 1/2	2,99	STA AS 10 R 1/2	2,01
12	S	1/4" BSP	AS 12 R 1/4	2,82	STA AS 12 R 1/4	1,74
12	S	3/8" BSP	AS 12 R 3/8	2,79	STA AS 12 R 3/8	1,71
12	S	1/2" BSP	AS 12 R 1/2	3,44	STA AS 12 R 1/2	2,34
14	S	3/8" BSP	AS 14 R 3/8	3,77	STA AS 14 R 3/8	2,10
14	S	1/2" BSP	AS 14 R 1/2	4,42	STA AS 14 R 1/2	2,73
16	S	3/8" BSP	AS 16 R 3/8	4,68	STA AS 16 R 3/8	2,73
16	S	1/2" BSP	AS 16 R 1/2	4,27	STA AS 16 R 1/2	2,34
16	S	3/4" BSP	AS 16 R 3/4	5,98	STA AS 16 R 3/4	3,99
20	S	1/2" BSP	AS 20 R 1/2	7,38	STA AS 20 R 1/2	4,80
20	S	3/4" BSP	AS 20 R 3/4	5,95	STA AS 20 R 3/4	3,42
25	S	3/4" BSP	AS 25 R 3/4	11,29	STA AS 25 R 3/4	6,61
25	S	1" BSP	AS 25 R 1	11,25	STA AS 25 R 1	6,57
30	S	1" BSP	AS 30 R 1	16,89	STA AS 30 R 1	9,98
30	S	1 1/4" BSP	AS 30 R 1 1/4	19,98	STA AS 30 R 1 1/4	12,98
38	S	1 1/4" BSP	AS 38 R 1 1/4	22,42	STA AS 38 R 1 1/4	13,37
38	S	1 1/2" BSP	AS 38 R 1 1/2	25,34	STA AS 38 R 1 1/2	16,20

# Racores DIN 2353

DIN 2353 Pipe fittings  
Raccords à bague DIN 2353  
Raccordi ad anello DIN 2353

## Racor recto rosca cilíndrica BSP con junta

Straight male stud coupling with captive seal  
BSP cyl

Union simple mâle gaz cyl avec joint plat

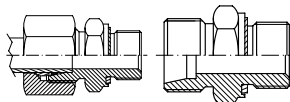

Raccordo di estremità diritto BSP con guarnizione

T.	S.	THREAD ROSCA	Part nº Referencia	€	Part Nº STA Referencia STA	€
6	L	1/8" BSP	AL 6 R 1/8 WD	1,75	STA AL 6 R 1/8 WD	1,08
6	L	1/4" BSP	AL 6 R 1/4 WD	1,93	STA AL 6 R 1/4 WD	1,26
8	L	1/8" BSP	AL 8 R 1/8 WD	2,21	STA AL 8 R 1/8 WD	1,56
8	L	1/4" BSP	AL 8 R 1/4 WD	1,70	STA AL 8 R 1/4 WD	1,06
8	L	3/8" BSP	AL 8 R 3/8 WD	2,20	STA AL 8 R 3/8 WD	1,55
10	L	1/4" BSP	AL 10 R 1/4 WD	1,69	STA AL 10 R 1/4 WD	0,90
10	L	3/8" BSP	AL 10 R 3/8 WD	2,11	STA AL 10 R 3/8 WD	1,31
10	L	1/2" BSP	AL 10 R 1/2 WD	2,86	STA AL 10 R 1/2 WD	2,04
12	L	1/4" BSP	AL 12 R 1/4 WD	2,11	STA AL 12 R 1/4 WD	1,21
12	L	3/8" BSP	AL 12 R 3/8 WD	2,20	STA AL 12 R 3/8 WD	1,31
12	L	1/2" BSP	AL 12 R 1/2 WD	2,88	STA AL 12 R 1/2 WD	1,96
15	L	3/8" BSP	AL 15 R 3/8 WD	3,36	STA AL 15 R 3/8 WD	2,07
15	L	1/2" BSP	AL 15 R 1/2 WD	3,36	STA AL 15 R 1/2 WD	2,07
15	L	3/4" BSP	AL 15 R 3/4 WD	5,42	STA AL 15 R 3/4 WD	4,07
18	L	1/2" BSP	AL 18 R 1/2 WD	3,97	STA AL 18 R 1/2 WD	2,16
18	L	3/4" BSP	AL 18 R 3/4 WD	4,17	STA AL 18 R 3/4 WD	2,37
22	L	1/2" BSP	AL 22 R 1/2 WD	5,79	STA AL 22 R 1/2 WD	3,36
22	L	3/4" BSP	AL 22 R 3/4 WD	5,36	STA AL 22 R 3/4 WD	2,94
22	L	1" BSP	AL 22 R 1 WD	8,30	STA AL 22 R 1 WD	5,80
28	L	3/4" BSP	AL 28 R 3/4 WD	9,79	STA AL 28 R 3/4 WD	6,12
28	L	1" BSP	AL 28 R 1 WD	9,79	STA AL 28 R 1 WD	6,12
35	L	1 1/4" BSP	AL 35 R 1 1/4 WD	15,52	STA AL 35 R 1 1/4 WD	9,81
42	L	1 1/2" BSP	AL 42 R 1 1/2 WD	22,90	STA AL 42 R 1 1/2 WD	14,50
6	S	1/4" BSP	AS 6 R 1/4 WD	2,28	STA AS 6 R 1/4 WD	1,54
8	S	1/4" BSP	AS 8 R 1/4 WD	2,23	STA AS 8 R 1/4 WD	1,47
8	S	3/8" BSP	AS 8 R 3/8 WD	2,72	STA AS 8 R 3/8 WD	1,95
10	S	1/4" BSP	AS 10 R 1/4 WD	2,62	STA AS 10 R 1/4 WD	1,65
10	S	3/8" BSP	AS 10 R 3/8 WD	3,20	STA AS 10 R 3/8 WD	2,22
10	S	1/2" BSP	AS 10 R 1/2 WD	2,99	STA AS 10 R 1/2 WD	2,01
12	S	1/4" BSP	AS 12 R 1/4 WD	2,86	STA AS 12 R 1/4 WD	1,79
12	S	3/8" BSP	AS 12 R 3/8 WD	2,86	STA AS 12 R 3/8 WD	1,79
12	S	1/2" BSP	AS 12 R 1/2 WD	3,44	STA AS 12 R 1/2 WD	2,34
14	S	1/2" BSP	AS 14 R 1/2 WD	4,42	STA AS 14 R 1/2 WD	2,73
16	S	3/8" BSP	AS 16 R 3/8 WD	4,24	STA AS 16 R 3/8 WD	2,30
16	S	1/2" BSP	AS 16 R 1/2 WD	4,27	STA AS 16 R 1/2 WD	2,34
16	S	3/4" BSP	AS 16 R 3/4 WD	4,49	STA AS 16 R 3/4 WD	2,54
20	S	3/4" BSP	AS 20 R 3/4 WD	6,14	STA AS 20 R 3/4 WD	3,60
25	S	3/4" BSP	AS 25 R 3/4 WD	11,10	STA AS 25 R 3/4 WD	6,44
25	S	1" BSP	AS 25 R 1 WD	11,25	STA AS 25 R 1 WD	6,57
30	S	1 1/4" BSP	AS 30 R 1 1/4 WD	18,05	STA AS 30 R 1 1/4 WD	11,10
38	S	1 1/2" BSP	AS 38 R 1 1/2 WD	25,67	STA AS 38 R 1 1/2 WD	16,79

## Racor recto rosca cónica NPT

Straight male stud coupling NPT

Union simple mâle NPT

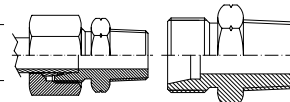

Raccordo di estremità diritto NPT conico

T.	S.	THREAD ROSCA	Part nº Referencia	€	Part Nº STA Referencia STA	€
4	LL	1/8" NPT	AKLL 4 1/8 NPT	2,35		*
6	LL	1/8" NPT	AKLL 6 1/8 NPT	2,31		*
8	LL	1/8" NPT	AKLL 8 1/8 NPT	2,58		*
6	L	1/8" NPT	AKL 6 1/8 NPT	1,70	STA AKL 6 1/8 NPT	1,03
6	L	1/4" NPT	AKL 6 1/4 NPT	2,04	STA AKL 6 1/4 NPT	1,37
8	L	1/4" NPT	AKL 8 1/4 NPT	2,00	STA AKL 8 1/4 NPT	1,35
10	L	1/4" NPT	AKL 10 1/4 NPT	2,35	STA AKL 10 1/4 NPT	1,54
10	L	3/8" NPT	AKL 10 3/8 NPT	3,31		*
12	L	1/4" NPT	AKL 12 1/4 NPT	2,20	STA AKL 12 1/4 NPT	1,30
12	L	3/8" NPT	AKL 12 3/8 NPT	2,46	STA AKL 12 3/8 NPT	1,55
12	L	1/2" NPT	AKL 12 1/2 NPT	3,50	STA AKL 12 1/2 NPT	2,56
15	L	1/2" NPT	AKL 15 1/2 NPT	3,85	STA AKL 15 1/2 NPT	2,56
18	L	1/2" NPT	AKL 18 1/2 NPT	4,44	STA AKL 18 1/2 NPT	2,63
22	L	3/4" NPT	AKL 22 3/4 NPT	6,06	STA AKL 22 3/4 NPT	3,62
28	L	1" NPT	AKL 28 1 NPT	13,24	STA AKL 28 1 NPT	9,47
35	L	1 1/4" NPT	AKL 35 1 1/4 NPT	26,41	STA AKL 35 1 1/4 NPT	20,38
42	L	1 1/2" NPT	AKL 42 1 1/2 NPT	36,42	STA AKL 42 1 1/2 NPT	27,64
6	S	1/4" NPT	AKS 6 1/4 NPT	2,02	STA AKS 6 1/4 NPT	1,30
8	S	1/4" NPT	AKS 8 1/4 NPT	2,59	STA AKS 8 1/4 NPT	1,82
10	S	1/4" NPT	AKS 10 1/4 NPT	2,03	STA AKS 10 1/4 NPT	1,08
10	S	3/8" NPT	AKS 10 3/8 NPT	2,94	STA AKS 10 3/8 NPT	1,96
12	S	3/8" NPT	AKS 12 3/8 NPT	3,67	STA AKS 12 3/8 NPT	2,56
12	S	1/2" NPT	AKS 12 1/2 NPT	3,26	STA AKS 12 1/2 NPT	2,16
14	S	1/2" NPT	AKS 14 1/2 NPT	3,83	STA AKS 14 1/2 NPT	2,16
16	S	1/2" NPT	AKS 16 1/2 NPT	4,87	STA AKS 16 1/2 NPT	2,91
20	S	3/4" NPT	AKS 20 3/4 NPT	6,53	STA AKS 20 3/4 NPT	3,98
25	S	1" NPT	AKS 25 1 NPT	11,18	STA AKS 25 1 NPT	6,51
30	S	1 1/4" NPT	AKS 30 1 1/4 NPT	29,95	STA AKS 30 1 1/4 NPT	22,66
38	S	1 1/2" NPT	AKS 38 1 1/2 NPT	40,58	STA AKS 38 1 1/2 NPT	31,00



# Racores DIN 2353

DIN 2353 Pipe fittings  
Raccords à bague DIN 2353  
Raccordi ad anello DIN 2353

## Racor recto rosca cilíndrica UNF

Straight male stud coupling UNF

Union simple mâle UNF

Raccordo di estremità diritto UNF

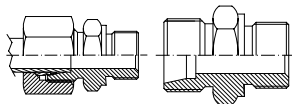

T.	S.	THREAD ROSCA	Part n° Referencia	€	Part N° STA Referencia STA	€
8	L	7/16 UNF	AL 8 7/16 UNF	*	STA AL 8 7/16 UNF	1,56
10	L	7/16 UNF	AL 10 7/16 UNF *	*	STA AL 10 7/16 UNF	1,89
12	L	9/16 UNF	AL 12 9/16 UNF	*	STA AL 12 9/16 UNF	8,76
12	L	3/4 UNF	AL 12 3/4 UNF	*	STA AL 12 3/4 UNF	9,68
12	L	7/8 UNF	AL 12 7/8 UNF	*	STA AL 12 7/8 UNF	3,14
15	L	3/4 UNF	AL 15 3/4 UNF	*	STA AL 15 3/4 UNF	3,27
15	L	7/8" UNF	AL 15 7/8 UNF	*	STA AL 15 7/8 UNF *	16,85
18	L	3/4 UNF	AL 18 3/4 UNF	*	STA AL 18 3/4 UNF	3,43
18	L	7/8 UNF	AL 18 7/8 UNF	*	STA AL 18 7/8 UNF	3,14
22	L	7/8 UNF	AL 22 7/8 UNF	*	STA AL 22 7/8 UNF	13,48
22	L	1 1/16 UNF	AL 22 1 1/16 UN	*	STA AL 22 1 1/16 UNF	13,78
22	L	1 5/16 UNF	AL 22 1 5/16 UN	*	STA AL 22 1 5/16 UNF	16,89
28	L	1 1/16 UNF	AL 28 1 1/16 UN	*	STA AL 28 1 1/16 UNF	17,08
28	L	1 5/16 UNF	AL 28 1 5/16 UN	*	STA AL 28 1 5/16 UNF	17,16
35	L	1 5/16 UNF	AL 35 1 5/16 UN	*	STA AL 35 1 5/16 UNF	22,19
35	L	1 5/8 UNF	AL 35 1 5/8 UNF	*	STA AL 35 1 5/8 UNF	25,31
8	S	7/16 UNF	AS 8 7/16 UNF	*	STA AS 8 7/16 UNF	8,25
10	S	9/16 UNF	AS 10 9/16 UNF	*	STA AS 10 9/16 UNF	8,93
12	S	9/16 UNF	AS 12 9/16 UNF	*	STA AS 12 9/16 UNF	9,67
12	S	3/4 UNF	AS 12 3/4 UNF	*	STA AS 12 3/4 UNF	9,92
16	S	3/4 UNF	AS 16 3/4 UNF	*	STA AS 16 3/4 UNF	11,03
20	S	3/4 UNF	AS 20 3/4 UNF	*	STA AS 20 3/4 UNF	13,88
20	S	7/8 UNF	AS 20 7/8 UNF	*	STA AS 20 7/8 UNF	14,42
20	S	1 1/16 UNF	AS 20 1 1/16 UN	*	STA AS 20 1 1/16 UNF	15,10
25	S	1 5/16 UNF	AS 25 1 5/16 UNF	*	STA AS 25 1 5/16 UNF	18,43
30	S	1 5/16 UNF	AS 30 1 5/16 UNF	*	STA AS 30 1 5/16 UNF	23,77

\*Hasta fin de existencias. / \*Until end of stock. / \*Jusqu'à fin du stock. / \*Fino ad esaurimento scorta.

## Racor recto rosca cilíndrica Métrica

Straight male stud coupling Metric cyl

Union simple mâle Métrique

Raccordo di estremità diritto cilindrico Metrico

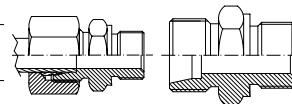

T.	S.	THREAD ROSCA	Part n° Referencia	€	Part N° STA Referencia STA	€
6	L	M10x1	AL 6 M 10X1	1,80	STA AL 6 M 10X1	1,13
8	L	M12x1,5	AL 8 M 12X1.5	2,11	STA AL 8 M 12X1.5	1,46
10	L	M14x1,5	AL 10 M 14X1.5	2,09	STA AL 10 M 14X1.5	1,29
10	L	M16x1,5	AL 10 M 16X1.5	2,84	STA AL 10 M 16X1.5	2,02
10	L	M18x1,5	AL 10 M 18X1.5	4,06	STA AL 10 M 18X1.5	3,20
10	L	M22x1,5	AL 10 M 22X1.5	3,95	STA AL 10 M 22X1.5	3,09
12	L	M14x1,5	AL 12 M 14X1.5	2,51	STA AL 12 M 14X1.5	1,60
12	L	M16x1,5	AL 12 M 16X1.5	2,52	STA AL 12 M 16X1.5	1,61
12	L	M18x1,5	AL 12 M 18X1.5	3,32	STA AL 12 M 18X1.5	2,38
12	L	M22x1,5	AL 12 M 22X1.5	4,04	STA AL 12 M 22X1.5	3,08
15	L	M16x1,5	AL 15 M 16X1.5	9,41	STA AL 15 M 16X1.5	7,95
15	L	M18x1,5	AL 15 M 18X1.5	3,71	STA AL 15 M 18X1.5	2,41
15	L	M22x1,5	AL 15 M 22X1.5	4,45	STA AL 15 M 22X1.5	3,13
18	L	M22x1,5	AL 18 M 22X1.5	4,46	STA AL 18 M 22X1.5	2,65
22	L	M22x1,5	AL 22 M 22X1.5	13,10	STA AL 22 M 22X1.5	10,46
22	L	M26x1,5	AL 22 M 26X1.5	7,29	STA AL 22 M 26X1.5	4,82
28	L	M33x2	AL 28 M 33X2	9,81	STA AL 28 M 33X2	6,14
35	L	M42x2	AL 35 M 42X2	18,58	STA AL 35 M 42X2	12,78
42	L	M48x2	AL 42 M 48X2	32,45	STA AL 42 M 48X2	23,77
6	S	M12x1,5	AS 6 M 12X1.5	1,90	STA AS 6 M 12X1.5	1,18
8	S	M14x1,5	AS 8 M 14X1.5	2,51	STA AS 8 M 14X1.5	1,75
10	S	M16x1,5	AS 10 M 16X1.5	2,48	STA AS 10 M 16X1.5	1,52
12	S	M18x1,5	AS 12 M 18X1.5	3,69	STA AS 12 M 18X1.5	2,58
12	S	M22x1,5	AS 12 M 22X1.5	10,01	STA AS 12 M 22X1.5	8,72
14	S	M20x1,5	AS 14 M 20X1.5	3,96	STA AS 14 M 20X1.5	2,28
16	S	M22x1,5	AS 16 M 22X1.5	5,35	STA AS 16 M 22X1.5	3,37
20	S	M27x2	AS 20 M 27X2	7,99	STA AS 20 M 27X2	5,40
25	S	M33x2	AS 25 M 33X2	10,54	STA AS 25 M 33X2	5,88
30	S	M42x2	AS 30 M 42X2	17,30	STA AS 30 M 42X2	10,38
38	S	M48x2	AS 38 M 48X2	22,91	STA AS 38 M 48X2	13,84

# Racores DIN 2353

DIN 2353 Pipe fittings  
Raccords à bague DIN 2353  
Raccordi ad anello DIN 2353

## Racor recto rosca cilíndrica Métrica con junta

Straight male stud coupling with captive seal  
Metrical cyl

Union simple mâle Métrique cyl + joint plat

Raccordo di estremità diritto cilindrico Metrico con guarnizione

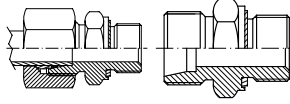

T.	S.	THREAD ROSCA	Part nº Referencia	€	Part Nº STA Referencia STA	€
6	L	M10x1	AL 6 M 10X1 WD	1,85	STA AL 6 M 10X1 WD	1,18
8	L	M12x1,5	AL 8 M 12X1.5 WD	2,17	STA AL 8 M 12X1.5 WD	1,52
10	L	M14x1,5	AL 10 M 14X1.5 WD	2,15	STA AL 10 M 14X1.5 WD	1,35
10	L	M16x1,5	AL 10 M 16X1.5 WD	2,93	STA AL 10 M 16X1.5 WD	2,10
10	L	M18x1,5	AL 10 M 18X1.5 WD	4,19	STA AL 10 M 18X1.5 WD	3,33
10	L	M22x1,5	AL 10 M 22X1.5 WD	4,08	STA AL 10 M 22X1.5 WD	3,22
12	L	M16x1,5	AL 12 M 16X1.5 WD	2,60	STA AL 12 M 16X1.5 WD	1,68
12	L	M18x1,5	AL 12 M 18X1.5 WD	3,42	STA AL 12 M 18X1.5 WD	2,48
12	L	M22x1,5	AL 12 M 22X1.5 WD	4,17	STA AL 12 M 22X1.5 WD	3,21
15	L	M18x1,5	AL 15 M 18X1.5 WD	3,81	STA AL 15 M 18X1.5 WD	2,51
15	L	M22x1,5	AL 15 M 22X1.5 WD	4,58	STA AL 15 M 22X1.5 WD	3,26
18	L	M18x1,5	AL 18 M 18X1.5 WD	10,43	STA AL 18 M 18X1.5 WD	8,45
18	L	M22x1,5	AL 18 M 22X1.5 WD	4,57	STA AL 18 M 22X1.5 WD	2,76
22	L	M26x1,5	AL 22 M 26X1.5 WD	7,51	STA AL 22 M 26X1.5 WD	5,03
28	L	M33x2	AL 28 M 33X2 WD	10,35	STA AL 28 M 33X2 WD	6,40
35	L	M42x2	AL 35 M 42X2 WD	19,13	STA AL 35 M 42X2 WD	13,31
42	L	M48x2	AL 42 M 48X2 WD	33,45	STA AL 42 M 48X2 WD	24,76
6	S	M12x1,5	AS 6 M 12X1.5 WD	1,95	STA AS 6 M 12X1.5 WD	1,23
8	S	M14x1,5	AS 8 M 14X1.5 WD	2,59	STA AS 8 M 14X1.5 WD	1,82
10	S	M16x1,5	AS 10 M 16X1.5 WD	2,55	STA AS 10 M 16X1.5 WD	1,59
12	S	M18x1,5	AS 12 M 18X1.5 WD	3,80	STA AS 12 M 18X1.5 WD	2,69
14	S	M20x1,5	AS 14 M 20X1.5 WD	4,06	STA AS 14 M 20X1.5 WD	2,38
16	S	M22x1,5	AS 16 M 22X1.5 WD	5,49	STA AS 16 M 22X1.5 WD	3,51
20	S	M27x2	AS 20 M 27X2 WD	8,22	STA AS 20 M 27X2 WD	5,62
25	S	M33x2	AS 25 M 33X2 WD	10,78	STA AS 25 M 33X2 WD	6,13
30	S	M42x2	AS 30 M 42X2 WD	17,76	STA AS 30 M 42X2 WD	10,82
38	S	M48x2	AS 38 M 48X2 WD	23,51	STA AS 38 M 48X2 WD	14,42

## Racor recto rosca cónica Métrica

Straight male stud coupling metrical tapered

Union simple mâle métrique type A

Raccordo di estremità diritto conico Metrico

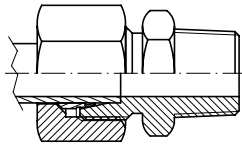

PIPE TUBO	SERIE	THREAD ROSCA	Part nº Referencia	€
4	LL	M 8x1	AKLL 4 M 8X1	1,60
6	LL	M 10x1	AKLL 6 M 10X1	1,72
8	LL	M 10x1	AKLL 8 M 10X1	1,87

## Reducción con rosca M-HF BSP con junta

Male-female reducing adaptor BSP cyl with captive seal

Réduction mâle gaz-femelle gaz avec joint plat

Adattatore di riduzione filettato maschio-femmina BSP con guarnizione

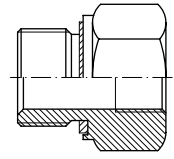

THREAD ROSCA		Part nº Referencia	€
M 1/8"BSP	F 1/4"BSP	RI-R 1/8 R 1/4WD	1,70
M 1/8"BSP	F 3/8"BSP	RI-R 1/8 R 3/8WD	2,47
M 1/4"BSP	F 1/8"BSP	RI-R 1/4 R 1/8WD	1,66
M 1/4"BSP	F 3/8"BSP	RI-R 1/4 R 3/8WD	2,63
M 1/4"BSP	F 1/2"BSP	RI-R 1/4 R 1/2 WD	4,48
M 1/4"BSP	F 3/4"BSP	RI-R 1/4 R 3/4 WD	11,79
M 3/8"BSP	F 1/8"BSP	RI-R 3/8 R 1/8WD	1,82
M 3/8"BSP	F 1/4"BSP	RI-R 3/8 R 1/4 WD	2,28
M 3/8"BSP	F 1/2"BSP	RI-R 3/8 R 1/2WD	4,53
M 3/8"BSP	F 3/4"BSP	RI-R 3/8 R 3/4WD	6,64
M 1/2"BSP	F 1/8"BSP	RI-R 1/2 R 1/8WD	2,67
M 1/2"BSP	F 1/4"BSP	RI-R 1/2 R 1/4WD	2,63
M 1/2"BSP	F 3/8"BSP	RI-R 1/2 R 3/8WD	3,25
M 1/2"BSP	F 3/4"BSP	RI-R 1/2 R 3/4WD	6,81
M 1/2"BSP	F 1"BSP	RI-R 1/2 R 1WD	8,39
M 1/2" BSP	F 1"1/4 BSP	RI-R 1/2 R 1 1/4WD	24,01
M 3/4"BSP	F 1/4"BSP	RI-R 3/4 R 1/4WD	4,14
M 3/4"BSP	F 3/8"BSP	RI-R 3/4 R 3/8WD	4,14
M 3/4"BSP	F 1/2"BSP	RI-R 3/4 R 1/2WD	5,10
M 3/4"BSP	F 1"BSP	RI-R 3/4 R 1WD	8,67
M 3/4"BSP	F 1"1/4 BSP	RI-R 3/4 R 1 1/4WD	16,10
M 3/4"BSP	F 1"1/2 BSP	RI-R 3/4 R 1 1/2WD	29,13
M 1"BSP	F 1/4"BSP	RI-R 1 R 1/4WD	6,77
M 1"BSP	F 3/8"BSP	RI-R 1 R 3/8WD	6,77
M 1"BSP	F 1/2"BSP	RI-R 1 R 1/2WD	6,77
M 1"BSP	F 3/4"BSP	RI-R 1 R 3/4WD	8,53
M 1"BSP	F 1"1/4BSP	RI-R 1 R 1 1/4WD	16,74
M 1"BSP	F 1"1/2 BSP	RI-R 1 R 1 1/2WD	29,84
M 1"1/4BSP	F 1/2"BSP	RI-R 1 1/4 R 1/2WD	10,73
M 1"1/4 BSP	F 3/4"BSP	RI-R 1 1/4 R 3/4WD	10,73
M 1"1/4 BSP	F 1"BSP	RI-R 1 1/4 R 1WD	13,79
M 1"1/4 BSP	F 1"1/2 BSP	RI-R 1 1/4 R 1 1/2WD	30,55
M 1"1/2 BSP	F 1"2"BSP	RI-R 1 1/2 R 1/2WD	13,25
M 1"1/2 BSP	F 3/4"BSP	RI-R 1 1/2 R 3/4WD	13,25
M 1"1/2 BSP	F 1" BSP	RI-R 1 1/2 R 1WD	13,25
M 1"1/2 BSP	F 1"1/4 BSP	RI-R 1 1/2 R 1 1/4WD	17,55

# Racores DIN 2353

DIN 2353 Pipe fittings  
Raccords à bague DIN 2353  
Raccordi ad anello DIN 2353

Pipe

## Racor en codo rosca cónica BSPT

Male stud elbow BSPT conical

Union coude mâle conique BSPT

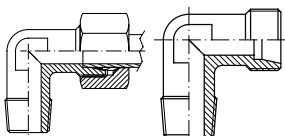

Raccordo a gomito, conico BSPT

T.	S.	THREAD ROSCA	Part n° Referencia	€	Part N° STA Referencia STA	€
4	LL	1/8" BSPT	CKLL 4 R 1/8	3,02	STA CKLL 4 R 1/8	2,39
6	LL	1/8" BSPT	CKLL 6 R 1/8	3,04	STA CKLL 6 R 1/8	2,39
8	LL	1/8" BSPT	CKLL 8 R 1/8	3,53	STA CKLL 8 R 1/8	2,78
6	L	1/8" BSPT	CKL 6 R 1/8	3,18	STA CKL 6 R 1/8	2,48
6	L	1/4" BSPT	CKL 6 R 1/4	3,38	STA CKL 6 R 1/4	2,67
8	L	1/8" BSPT	CKL 8 R 1/8	4,23	STA CKL 8 R 1/8	3,52
8	L	1/4" BSPT	CKL 8 R 1/4	4,23	STA CKL 8 R 1/4	3,52
8	L	3/8" BSPT	CKL 8 R 3/8	5,06	STA CKL 8 R 3/8	4,32
10	L	1/4" BSPT	CKL 10 R 1/4	3,94	STA CKL 10 R 1/4	3,08
10	L	3/8" BSPT	CKL 10 R 3/8	3,94	STA CKL 10 R 3/8	3,08
10	L	1/2" BSPT	CKL 10 R 1/2	6,73	STA CKL 10 R 1/2	5,79
12	L	1/4" BSPT	CKL 12 R 1/4	4,04	STA CKL 12 R 1/4	3,08
12	L	3/8" BSPT	CKL 12 R 3/8	3,81	STA CKL 12 R 3/8	2,86
12	L	1/2" BSPT	CKL 12 R 1/2	6,92	STA CKL 12 R 1/2	5,88
15	L	3/8" BSPT	CKL 15 R 3/8	7,00	STA CKL 15 R 3/8	5,61
15	L	1/2" BSPT	CKL 15 R 1/2	7,28	STA CKL 15 R 1/2	5,88
18	L	1/2" BSPT	CKL 18 R 1/2	10,58	STA CKL 18 R 1/2	8,59
22	L	3/4" BSPT	CKL 22 R 3/4	18,19	STA CKL 22 R 3/4	15,40
28	L	1" BSPT	CKL 28 R 1	22,31	STA CKL 28 R 1	18,28
35	L	1" 1/4 BSPT	CKL 35 R 1 1/4	34,59	STA CKL 35 R 1 1/4	28,32
42	L	1" 1/2 BSPT	CKL 42 R 1 1/2	53,64	STA CKL 42 R 1 1/2	44,35
6	S	1/4" BSPT	CKS 6 R 1/4	4,13	STA CKS 6 R 1/4	3,35
8	S	1/4" BSPT	CKS 8 R 1/4	4,65	STA CKS 8 R 1/4	3,82
10	S	3/8" BSPT	CKS 10 R 3/8	5,39	STA CKS 10 R 3/8	4,34
12	S	3/8" BSPT	CKS 12 R 3/8	6,47	STA CKS 12 R 3/8	5,28
12	S	1/2" BSPT	CKS 12 R 1/2	7,56	STA CKS 12 R 1/2	6,34
14	S	1/2" BSPT	CKS 14 R 1/2	9,96	STA CKS 14 R 1/2	8,11
16	S	1/2" BSPT	CKS 16 R 1/2	8,31	STA CKS 16 R 1/2	6,25
20	S	3/4" BSPT	CKS 20 R 3/4	21,51	STA CKS 20 R 3/4	18,52
25	S	1" BSPT	CKS 25 R 1	32,46	STA CKS 25 R 1	27,17
30	S	1" 1/4 BSPT	CKS 30 R 1 1/4	51,44	STA CKS 30 R 1 1/4	43,52
38	S	1" 1/2 BSPT	CKS 38 R 1 1/2	73,98	STA CKS 38 R 1 1/2	63,42

## Racor en codo rosca cónica Métrica

Male stud elbow Metrical conical

Union coude mâle conique Métrique

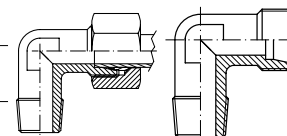

Raccordo a gomito, conico Metrico

T.	S.	THREAD ROSCA	Part n° Referencia	€	Part N° STA Referencia STA	€
4	LL	M8x1	CKLL 4 M 8X1	2,78	STA CKLL 4 M 8X1	2,16
6	LL	M10x1	CKLL 6 M 10X1	3,16	STA CKLL 6 M 10X1	2,52
8	LL	M10x1	CKLL 8 M 10X1	3,64	STA CKLL 8 M 10X1	2,88
6	L	M10x1	CKL 6 M 10X1	3,96	STA CKL 6 M 10X1	3,23
8	L	M12x1,5	CKL 8 M 12X1.5	4,46	STA CKL 8 M 12X1.5	*
10	L	M14x1,5	CKL 10 M 14X1.5	5,15	STA CKL 10 M 14X1.5	*
12	L	M16x1,5	CKL 12 M 16X1.5	5,84	STA CKL 12 M 16X1.5	4,83
15	L	M18x1,5	CKL 15 M 18X1.5	7,90	STA CKL 15 M 18X1.5	6,48
18	L	M22x1,5	CKL 18 M 22X1.5	*	STA CKL 18 M 22X1.5	*
6	S	M12x1,5	CKS 6 M 12X1.5	21,07	STA CKS 6 M 12X1.5	19,80
8	S	M14x1,5	CKS 8 M 14X1.5	21,62	STA CKS 8 M 14X1.5	20,30
10	S	M16x1,5	CKS 10 M 16X1.5	5,94	STA CKS 10 M 16X1.5	4,88
14	S	M20x1,5	CKS 14 M 20X1.5	25,13	STA CKS 14 M 20X1.5	22,84
16	S	M22x1,5	CKS 16 M 22X1.5	28,75	STA CKS 16 M 22X1.5	26,10

DIN 2353 Pipe  
Fittings

Gas tube fittings

JIC 37° fittings

SAE Flanges

## Racor en codo rosca cónica NPT

Male stud elbow NPT conical

Union coude mâle gaz conique NPT

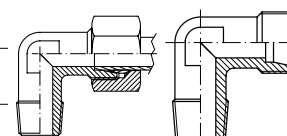

Raccordo a gomito, conico NPT

T.	S.	THREAD ROSCA	Part n° Referencia	€	Part N° STA Referencia STA	€
4	LL	1/8" NPT	CKLL 4 1/8 NPT	5,70	STA CKLL 4 1/8 NPT	5,00
6	LL	1/8" NPT	CKLL 6 1/8 NPT	5,74	STA CKLL 6 1/8 NPT	5,02
8	LL	1/8" NPT	CKLL 8 1/8 NPT	6,55	STA CKLL 8 1/8 NPT	5,71
6	L	1/8" NPT	CKL 6 1/8 NPT	3,00	STA CKL 6 1/8 NPT	2,29
6	L	1/4" NPT	CKL 6 1/4 NPT	4,00	STA CKL 6 1/4 NPT	3,26
8	L	1/4" NPT	CKL 8 1/4 NPT	3,97	STA CKL 8 1/4 NPT	3,26
10	L	1/4" NPT	CKL 10 1/4 NPT	4,54	STA CKL 10 1/4 NPT	3,67
12	L	1/4" NPT	CKL 12 1/4 NPT	5,28	STA CKL 12 1/4 NPT	4,30
12	L	3/8" NPT	CKL 12 3/8 NPT	5,36	STA CKL 12 3/8 NPT	4,36
12	L	1/2" NPT	CKL 12 1/2 NPT	6,85	STA CKL 12 1/2 NPT	5,81
15	L	1/2" NPT	CKL 15 1/2 NPT	7,92	STA CKL 15 1/2 NPT	6,51
18	L	1/2" NPT	CKL 18 1/2 NPT	10,26	STA CKL 18 1/2 NPT	8,28
22	L	3/4" NPT	CKL 22 3/4 NPT	14,51	STA CKL 22 3/4 NPT	11,83
28	L	1" NPT	CKL 28 1 NPT	22,31	STA CKL 28 1 NPT	18,28
35	L	1 1/4" NPT	CKL 35 1 1/4 NPT	50,24	STA CKL 35 1 1/4 NPT	43,52
42	L	1 1/2" NPT	CKL 42 1 1/2 NPT	73,27	STA CKL 42 1 1/2 NPT	63,42
6	S	1/4" NPT	CKS 6 1/4 NPT	7,38	STA CKS 6 1/4 NPT	6,50
8	S	1/4" NPT	CKS 8 1/4 NPT	7,57	STA CKS 8 1/4 NPT	6,66
10	S	3/8" NPT	CKS 10 3/8 NPT	8,47	STA CKS 10 3/8 NPT	7,33
12	S	3/8" NPT	CKS 12 3/8 NPT	6,13	STA CKS 12 3/8 NPT	4,95
14	S	1/2" NPT	CKS 14 1/2 NPT	19,91	STA CKS 14 1/2 NPT	17,77
16	S	1/2" NPT	CKS 16 1/2 NPT	10,40	STA CKS 16 1/2 NPT	8,28
20	S	3/4" NPT	CKS 20 3/4 NPT	14,83	STA CKS 20 3/4 NPT	12,04
25	S	1" NPT	CKS 25 1 NPT	23,86	STA CKS 25 1 NPT	18,82
30	S	1 1/4" NPT	CKS 30 1 1/4 NPT	51,44	STA CKS 30 1 1/4 NPT	43,52
38	S	1 1/2" NPT	CKS 38 1 1/2 NPT	73,98	STA CKS 38 1 1/2 NPT	63,42

Clamps

Machines for  
processing rigid pipes

# Racores DIN 2353

DIN 2353 Pipe fittings

Raccords à bague DIN 2353

Raccordi ad anello DIN 2353

## Racor de reducción TL Métrica (serie ligera)

Standpipe reducers with taper (L)

Union simple femelle tournante Métrique (L)

Raccordo di riduzione cono 24 (L)

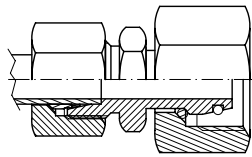

T.	S.	Part n° Referencia	€	Part N° STA Referencia STA	€
6	8	L KORL 8-6TLM	4,06	STA KORL 8-6TLM	2,73
6	10	L KORL 10-6TLM	4,65	STA KORL 10-6 TLM	3,15
8	10	L KORL 10-8 TLM	4,08	STA KORL 10-8 TLM	2,63
6	12	L KORL 12-6TLM	4,33	STA KORL 12-6 TLM	2,74
8	12	L KORL 12-8TLM	3,16	STA KORL 12-8 TLM	1,64
10	12	L KORL 12-10TLM	4,63	STA KORL 12-10 TLM	2,91
6	15	L KORL 15-6TLM	13,58	STA KORL 15-6 TLM	11,37
8	15	L KORL 15-8TLM	6,73	STA KORL 15-8 TLM	4,74
10	15	L KORL 15-10TLM	5,55	STA KORL 15-10 TLM	3,46
12	15	L KORL 15-12TLM	5,59	STA KORL 15-12 TLM	3,40
6	18	L KORL 18-6TLM	16,30	STA KORL 18-6 TLM	13,52
8	18	L KORL 18-8TLM	16,28	STA KORL 18-8 TLM	13,53
10	18	L KORL 18-10TLM	6,95	STA KORL 18-10 TLM	4,33
12	18	L KORL 18-12TLM	8,59	STA KORL 18-12 TLM	5,82
15	18	L KORL 18-15TLM	9,69	STA KORL 18-15 TLM	6,54
6	22	L KORL 22-6TLM	18,02	STA KORL 22-6 TLM	*
8	22	L KORL 22-8TLM	18,23	STA KORL 22-8 TLM	*
10	22	L KORL 22-10TLM	18,62	STA KORL 22-10 TLM	15,08
12	22	L KORL 22-12TLM	11,60	STA KORL 22-12 TLM	8,16
15	22	L KORL 22-15TLM	11,96	STA KORL 22-15 TLM	8,16
18	22	L KORL 22-18TLM	11,63	STA KORL 22-18 TLM	7,35
6	28	L KORL 28-6TLM	21,91	STA KORL 28-6 TLM	*
8	28	L KORL 28-8TLM	22,11	STA KORL 28-8 TLM	*
10	28	L KORL 28-10TLM	22,38	STA KORL 28-10 TLM	*
12	28	L KORL 28-12TLM	23,43	STA KORL 28-12 TLM	18,54
15	28	L KORL 28-15TLM	16,35	STA KORL 28-15 TLM	11,30
18	28	L KORL 28-18TLM	16,85	STA KORL 28-18 TLM	11,30
22	28	L KORL 28-22TLM	14,47	STA KORL 28-22 TLM	8,40
15	35	L KORL 35-15TLM	33,89	STA KORL 35-15 TLM	26,45
18	35	L KORL 35-18TLM	34,40	STA KORL 35-18 TLM	26,45
22	35	L KORL 35-22TLM	23,97	STA KORL 35-22 TLM	15,75
28	35	L KORL 35-28TLM	29,62	STA KORL 35-28 TLM	20,12
18	42	L KORL 42-18TLM	52,51	STA KORL 42-18 TLM	41,57
22	42	L KORL 42-22TLM	53,60	STA KORL 42-22 TLM	42,05
28	42	L KORL 42-28TLM	55,03	STA KORL 42-28 TLM	42,32
35	42	L KORL 42-35TLM	37,17	STA KORL 42-35 TLM	23,11

## Racor de reducción TL Métrica (serie pesada)

Standpipe reducers with taper (S)

Union simple femelle tournante Métrique (S)

Raccordo di riduzione cono 24 (S)

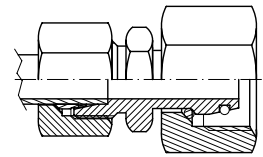

T.	S.	Part n° Referencia	€	Part N° STA Referencia STA	€
6	8	S KORS 8-6TLM	11,21	STA KORS 8-6 TLM	9,53
6	10	S KORS 10-6TLM	12,34	STA KORS 10-6 TLM	10,43
8	10	S KORS 10-8TLM	12,27	STA KORS 10-8 TLM	10,33
6	12	S KORS 12-6TLM	12,64	STA KORS 12-6 TLM	10,60
8	12	S KORS 12-8TLM	12,66	STA KORS 12-8 TLM	10,60
10	12	S KORS 12-10TLM	6,59	STA KORS 12-10 TLM	4,51
6	14	S KORS 14-6TLM	14,68	STA KORS 14-6 TLM	12,02
8	14	S KORS 14-8TLM	14,72	STA KORS 14-8 TLM	12,04
10	14	S KORS 14-10TLM	14,77	STA KORS 14-10 TLM	12,04
12	14	S KORS 14-12TLM	7,51	STA KORS 14-12 TLM	4,73
8	16	S KORS 16-8TLM	9,05	STA KORS 16-8 TLM	6,29
10	16	S KORS 16-10TLM	16,95	STA KORS 16-10 TLM	13,90
12	16	S KORS 16-12TLM	8,53	STA KORS 16-12 TLM	5,46
14	16	S KORS 16-14TLM	18,48	STA KORS 16-14 TLM	14,56
6	20	S KORS 20-6TLM	20,27	STA KORS 20-6 TLM	16,66
8	20	S KORS 20-8TLM	20,29	STA KORS 20-8 TLM	16,66
10	20	S KORS 20-10TLM	20,51	STA KORS 20-10 TLM	16,66
12	20	S KORS 20-12TLM	13,08	STA KORS 20-12 TLM	9,34
14	20	S KORS 20-14TLM	25,80	STA KORS 20-14 TLM	21,13
16	20	S KORS 20-16TLM	12,41	STA KORS 20-16 TLM	7,88
6	25	S KORS 25-6TLM	26,17	STA KORS 25-6 TLM	20,40
8	25	S KORS 25-8TLM	26,20	STA KORS 25-8 TLM	20,41
10	25	S KORS 25-10TLM	26,41	STA KORS 25-10 TLM	20,40
12	25	S KORS 25-12TLM	17,96	STA KORS 25-12 TLM	12,10
14	25	S KORS 25-14TLM	27,66	STA KORS 25-14 TLM	20,95
16	25	S KORS 25-16TLM	16,08	STA KORS 25-16 TLM	9,45
20	25	S KORS 25-20TLM	16,65	STA KORS 25-20 TLM	9,45
12	30	S KORS 30-12TLM	35,35	STA KORS 30-12 TLM	*
16	30	S KORS 30-16TLM	37,23	STA KORS 30-16 TLM	*
20	30	S KORS 30-20TLM	*	STA KORS 30-20 TLM	*
25	30	S KORS 30-25TLM	38,66	STA KORS 30-25 TLM	*
12	38	S KORS 38-12TLM	50,57	STA KORS 38-12 TLM	*
16	38	S KORS 38-16TLM	52,63	STA KORS 38-16 TLM	*
20	38	S KORS 38-20TLM	55,36	STA KORS 38-20 TLM	*
25	38	S KORS 38-25TLM	62,29	STA KORS 38-25 TLM	*
30	38	S KORS 38-30TLM	66,87	STA KORS 38-30 TLM	*

# Racores DIN 2353

DIN 2353 Pipe fittings  
Raccords à bague DIN 2353  
Raccordi ad anello DIN 2353

## Racor en codo regulable con tuerca y anillo

Adjustable stud elbow with nut and ring

Coude orientable tube lisse équipé

Raccordo orientabile a 90° con dado e anello

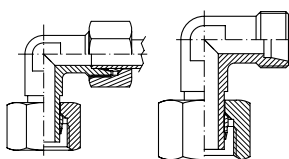

PIPE TUBO	SERIE	THREAD ROSCA	Part nº Referencia	€	Part Nº STA Referencia STA	€
6	L	M12x1,5	EEL 6 CTA	5,69	STA EEL 6 CTA	4,90
8	L	M14x1,5	EEL 8 CTA	5,68	STA EEL 8 CTA	4,92
10	L	M16x1,5	EEL 10 CTA	6,57	STA EEL 10 CTA	5,64
12	L	M18x1,5	EEL 12 CTA	7,62	STA EEL 12 CTA	6,56
15	L	M22x1,5	EEL 15 CTA	9,11	STA EEL 15 CTA	7,65
18	L	M26x1,5	EEL 18 CTA	12,02	STA EEL 18 CTA	9,99
22	L	M30x2	EEL 22 CTA	18,74	STA EEL 22 CTA	15,93
28	L	M36x2	EEL 28 CTA	27,75	STA EEL 28 CTA	23,56
35	L	M45x2	EEL 35 CTA	47,61	STA EEL 35 CTA	40,99
42	L	M52x2	EEL 42 CTA	67,70	STA EEL 42 CTA	58,01
6	S	M14x1,5	EES 6 CTA	6,48	STA EES 6 CTA	5,63
8	S	M16x1,5	EES 8 CTA	7,22	STA EES 8 CTA	6,32
10	S	M18x1,5	EES 10 CTA	8,36	STA EES 10 CTA	7,23
12	S	M20x1,5	EES 12 CTA	8,12	STA EES 12 CTA	6,88
14	S	M22x1,5	EES 14 CTA	15,62	STA EES 14 CTA	13,60
16	S	M24x1,5	EES 16 CTA	13,23	STA EES 16 CTA	11,02
20	S	M30x2	EES 20 CTA	19,31	STA EES 20 CTA	16,39
25	S	M36x2	EES 25 CTA	34,20	STA EES 25 CTA	28,85
30	S	M42x2	EES 30 CTA	49,43	STA EES 30 CTA	41,57
38	S	M52x2	EES 38 CTA	69,25	STA EES 38 CTA	58,83

## Racor en T regulable con tuerca y anillo

Adjustable stud branch TEE with nut and ring

Té Orientable tube lisse équipé au centre

Raccordo orientabile a T con dado e anello centrale

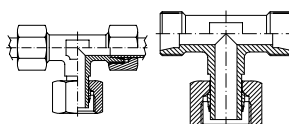

PIPE TUBO	SERIE	THREAD ROSCA	Part nº Referencia	€	Part Nº STA Referencia STA	€
6	L	M12x1,5	TEL 6 CTA	6,47	STA TEL 6 CTA	5,04
8	L	M14x1,5	TEL 8 CTA	6,92	STA TEL 8 CTA	5,54
10	L	M16x1,5	TEL 10 CTA	6,92	STA TEL 10 CTA	5,24
12	L	M18x1,5	TEL 12 CTA	7,82	STA TEL 12 CTA	5,91
15	L	M22x1,5	TEL 15 CTA	11,79	STA TEL 15 CTA	9,07
18	L	M26x1,5	TEL 18 CTA	15,91	STA TEL 18 CTA	12,09
22	L	M30x2	TEL 22 CTA	19,19	STA TEL 22 CTA	14,11
28	L	M36x2	TEL 28 CTA	33,96	STA TEL 28 CTA	26,21
35	L	M45x2	TEL 35 CTA	44,06	STA TEL 35 CTA	32,26
42	L	M52x2	TEL 42 CTA	67,84	STA TEL 42 CTA	50,40
6	S	M14x1,5	TES 6 CTA	7,07	STA TES 6 CTA	5,54
8	S	M16x1,5	TES 8 CTA	7,18	STA TES 8 CTA	5,59
10	S	M18x1,5	TES 10 CTA	10,15	STA TES 10 CTA	8,07
12	S	M20x1,5	TES 12 CTA	11,66	STA TES 12 CTA	9,32
14	S	M22x1,5	TES 14 CTA	14,64	STA TES 14 CTA	11,09
16	S	M24x1,5	TES 16 CTA	16,23	STA TES 16 CTA	12,12
20	S	M30x2	TES 20 CTA	20,44	STA TES 20 CTA	15,12
25	S	M36x2	TES 25 CTA	38,04	STA TES 25 CTA	28,23
30	S	M42x2	TES 30 CTA	50,60	STA TES 30 CTA	36,29
38	S	M52x2	TES 38 CTA	84,49	STA TES 38 CTA	65,23

Hasta fin de existencias. / Until end of stock. / Jusqu'à la fin du stock. / Fino ad esaurimento scorta.

## Racor en L regulable con tuerca y anillo

Adjustable stud barrel L with nut and ring

L Orientable renversé tube lisse équipé

Raccordo orientabile a T con dado e anello laterale

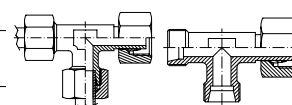

PIPE TUBO	SERIE	THREAD ROSCA	Part nº Referencia	€	Part Nº STA Referencia STA	€
6	L	M12x1,5	LEL 6 CTA	6,47	STA LEL 6 CTA	5,04
8	L	M14x1,5	LEL 8 CTA	6,92	STA LEL 8 CTA	5,54
10	L	M16x1,5	LEL 10 CTA	6,92	STA LEL 10 CTA	5,24
12	L	M18x1,5	LEL 12 CTA	7,82	STA LEL 12 CTA	5,91
15	L	M22x1,5	LEL 15 CTA	11,79	STA LEL 15 CTA	9,07
18	L	M26x1,5	LEL 18 CTA	13,56	STA LEL 18 CTA	9,80
22	L	M30x2	LEL 22 CTA	19,19	STA LEL 22 CTA	14,11
28	L	M36x2	LEL 28 CTA	33,96	STA LEL 28 CTA	26,21
35	L	M45x2	LEL 35 CTA	44,06	STA LEL 35 CTA	32,26
6	S	M14x1,5	LES 6 CTA	7,07	STA LES 6 CTA	5,54
8	S	M16x1,5	LES 8 CTA	7,65	STA LES 8 CTA	6,05
10	S	M18x1,5	LES 10 CTA	10,15	STA LES 10 CTA	8,07
12	S	M20x1,5	LES 12 CTA	12,44	STA LES 12 CTA	10,08
16	S	M24x1,5	LES 16 CTA	17,25	STA LES 16 CTA	13,11
20	S	M30x2	LES 20 CTA	20,44	STA LES 20 CTA	15,12
25	S	M36x2	LES 25 CTA	38,04	STA LES 25 CTA	28,23
30	S	M42x2	LES 30 CTA	50,60	STA LES 30 CTA	36,29
38	S	M52x2	LES 38 CTA	79,60	STA LES 38 CTA	60,48

Hasta fin de existencias. / Until end of stock. / Jusqu'à la fin du stock. / Fino ad esaurimento scorta.

# Racores DIN 2353

DIN 2353 Pipe fittings  
Raccords à bague DIN 2353  
Raccordi ad anello DIN 2353

## Racor en codo tubo-TL Métrica

Adjustable stud elbow with o'ring

Coude orientable Métrique + o'ring

Raccordo orientabile a 90° con o'ring

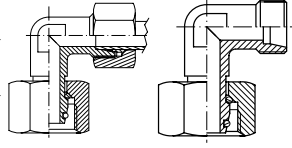

PIPE TUBO	SERIE	THREAD ROSCA	Part nº Referencia	€	Part Nº STA Referencia STA	€
6	L	M12x1,5	EEL 6 TLM	4,92	STA EEL 6 TLM	4,16
8	L	M14x1,5	EEL 8 TLM	5,82	STA EEL 8 TLM	5,06
10	L	M16x1,5	EEL 10 TLM	5,75	STA EEL 10 TLM	4,84
12	L	M18x1,5	EEL 12 TLM	5,49	STA EEL 12 TLM	4,49
15	L	M22x1,5	EEL 15 TLM	8,61	STA EEL 15 TLM	7,17
18	L	M26x1,5	EEL 18 TLM	9,55	STA EEL 18 TLM	7,59
22	L	M30x2	EEL 22 TLM	16,58	STA EEL 22 TLM	13,84
28	L	M36x2	EEL 28 TLM	20,97	STA EEL 28 TLM	16,98
35	L	M45x2	EEL 35 TLM	41,82	STA EEL 35 TLM	35,34
42	L	M52x2	EEL 42 TLM	61,66	STA EEL 42 TLM	52,14
6	S	M14x1,5	EES 6 TLM	6,17	STA EES 6 TLM	5,32
8	S	M16x1,5	EES 8 TLM	6,78	STA EES 8 TLM	5,89
10	S	M18x1,5	EES 10 TLM	7,57	STA EES 10 TLM	6,46
12	S	M20x1,5	EES 12 TLM	8,56	STA EES 12 TLM	7,31
14	S	M22x1,5	EES 14 TLM	11,69	STA EES 14 TLM	9,79
16	S	M24x1,5	EES 16 TLM	12,76	STA EES 16 TLM	10,57
20	S	M30x2	EES 20 TLM	16,90	STA EES 20 TLM	14,05
25	S	M36x2	EES 25 TLM	28,09	STA EES 25 TLM	22,92
30	S	M42x2	EES 30 TLM	42,94	STA EES 30 TLM	35,27
38	S	M52x2	EES 38 TLM	*	STA EES 38 TLM	*

## Racor en L tubo-TL Métrica

Adjustable stud barrel L with o'ring

L Orientable renversé Métrique + o'ring

Raccordo orientabile a T con o'ring laterale

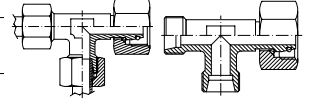

PIPE TUBO	SERIE	THREAD ROSCA	Part nº Referencia	€	Part Nº STA Referencia STA	€
6	L	M12x1,5	LEL 6 TLM	6,68	STA LEL 6 TLM	5,25
8	L	M14x1,5	LEL 8 TLM	7,17	STA LEL 8 TLM	5,77
10	L	M16x1,5	LEL 10 TLM	7,15	STA LEL 10 TLM	5,46
12	L	M18x1,5	LEL 12 TLM	8,07	STA LEL 12 TLM	6,16
15	L	M22x1,5	LEL 15 TLM	12,18	STA LEL 15 TLM	9,45
18	L	M26x1,5	LEL 18 TLM	13,98	STA LEL 18 TLM	10,21
22	L	M30x2	LEL 22 TLM	19,80	STA LEL 22 TLM	14,70
28	L	M36x2	LEL 28 TLM	35,08	STA LEL 28 TLM	27,30
35	L	M45x2	LEL 35 TLM	45,45	STA LEL 35 TLM	33,61
42	L	M52x2	LEL 42 TLM	69,99	STA LEL 42 TLM	52,50
6	S	M14x1,5	LES 6 TLM	7,32	STA LES 6 TLM	5,77
8	S	M16x1,5	LES 8 TLM	7,91	STA LES 8 TLM	6,30
10	S	M18x1,5	LES 10 TLM	10,49	STA LES 10 TLM	8,40
12	S	M20x1,5	LES 12 TLM	12,87	STA LES 12 TLM	10,50
14	S	M22x1,5	LES 14 TLM	15,11	STA LES 14 TLM	11,55
16	S	M24x1,5	LES 16 TLM	17,81	STA LES 16 TLM	13,65
20	S	M30x2	LES 20 TLM	21,08	STA LES 20 TLM	15,75
25	S	M36x2	LES 25 TLM	39,24	STA LES 25 TLM	29,40
30	S	M42x2	LES 30 TLM	52,16	STA LES 30 TLM	37,80
38	S	M52x2	LES 38 TLM	82,19	STA LES 38 TLM	63,00

## Racor en T tubo-TL Métrica

Adjustable stud branch TEE with o'ring

Té Orientable Métrique + o'ring

Raccordo orientabile a T con o'ring centrale

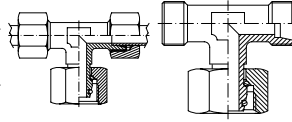

PIPE TUBO	SERIE	THREAD ROSCA	Part nº Referencia	€	Part Nº STA Referencia STA	€
6	L	M12x1,5	TEL 6 TLM	6,68	STA TEL 6 TLM	5,25
8	L	M14x1,5	TEL 8 TLM	7,17	STA TEL 8 TLM	5,77
10	L	M16x1,5	TEL 10 TLM	7,15	STA TEL 10 TLM	5,46
12	L	M18x1,5	TEL 12 TLM	8,07	STA TEL 12 TLM	6,16
15	L	M22x1,5	TEL 15 TLM	12,18	STA TEL 15 TLM	9,45
18	L	M26x1,5	TEL 18 TLM	16,44	STA TEL 18 TLM	12,60
22	L	M30x2	TEL 22 TLM	19,80	STA TEL 22 TLM	14,70
28	L	M36x2	TEL 28 TLM	35,08	STA TEL 28 TLM	27,30
35	L	M45x2	TEL 35 TLM	45,45	STA TEL 35 TLM	33,61
42	L	M52x2	TEL 42 TLM	69,99	STA TEL 42 TLM	52,50
6	S	M14x1,5	TES 6 TLM	7,32	STA TES 6 TLM	5,77
8	S	M16x1,5	TES 8 TLM	7,42	STA TES 8 TLM	5,83
10	S	M18x1,5	TES 10 TLM	10,49	STA TES 10 TLM	8,40
12	S	M20x1,5	TES 12 TLM	12,06	STA TES 12 TLM	9,71
14	S	M22x1,5	TES 14 TLM	15,11	STA TES 14 TLM	11,55
16	S	M24x1,5	TES 16 TLM	16,74	STA TES 16 TLM	12,62
20	S	M30x2	TES 20 TLM	21,08	STA TES 20 TLM	15,75
25	S	M36x2	TES 25 TLM	39,24	STA TES 25 TLM	29,40
30	S	M42x2	TES 30 TLM	52,16	STA TES 30 TLM	37,80
38	S	M52x2	TES 38 TLM	87,28	STA TES 38 TLM	67,94

# Racores DIN 2353

DIN 2353 Pipe fittings  
Raccords à bague DIN 2353  
Raccordi ad anello DIN 2353

Pipe

DIN 2353 Pipe  
Fittings

## Racor unión TL-TL Métrica

*Straight connection with o'ring*

*Union tournante Métrique égale*

*Raccordo di estremità diritto Metrico con o'ring*

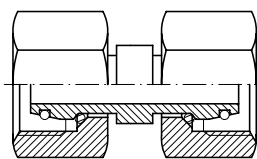

PIPE TUBO	SERIE	Part nº Referencia	€
6	L	ATL 6	8,19
8	L	ATL 8	3,75
10	L	ATL 10	4,27
12	L	ATL 12	5,08
15	L	ATL 15	6,27
18	L	ATL 18	7,93
22	L	ATL 22	16,72
28	L	ATL 28	20,47
35	L	ATL 35	31,17
42	L	ATL 42	49,67
6	S	ATS 6	8,62
8	S	ATS 8	9,47
10	S	ATS 10	10,50
12	S	ATS 12	11,34
14	S	ATS 14	13,02
16	S	ATS 16	8,04
20	S	ATS 20	17,63
25	S	ATS 25	22,98
30	S	ATS 30	34,15
38	S	ATS 38	51,60

## Tubo roscado recto métrico TLM con junta

*Straight stud metric standpipe adpt.w/captive seal-o'ring Met. cyl*

*Adapteur tube lisse x mâle met.a/écrou Met.+o'ring*

*Adattatore diritto Metrico TLM*

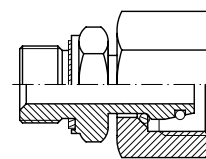

PIPE TUBO	SERIE	THREAD ROSCA	Part nº Referencia	€
6	L	M10X1	RAL 6 TLM M 10X1	9,14
8	L	M12X1.5	RAL 8 TLM M 12X1.5	10,12
10	L	M14X1.5	RAL 10 TLM M 14X1.5	11,85
12	L	M16X1.5	RAL 12 TLM M 16X1.5	13,43
15	L	M18X1.5	RAL 15 TLM M 18X1.5	13,73
18	L	M22X1.5	RAL 18 TLM M 22X1.5	15,33
22	L	M26X1.5	RAL 22 TLM M 26X1.5	19,66
28	L	M33X2	RAL 28 TLM M 33X2	28,04
35	L	M42X2	RAL 35 TLM M 42X2	42,83
42	L	M48X2	RAL 42 TLM M 48X2	57,37
6	S	M12X1.5	RAS 6 TLM M 12X1.5	9,92
8	S	M14X1.5	RAS 8 TLM M 14X1.5	10,87
10	S	M16X1.5	RAS 10 TLM M 16X1.5	13,72
12	S	M18X1.5	RAS 12 TLM M 18X1.5	13,43
14	S	M20X1.5	RAS 14 TLM M 20X1.5	16,32
16	S	M22X1.5	RAS 16 TLM M 22X1.5	13,80
20	S	M27X2	RAS 20 TLM M 27X2	22,04
25	S	M33X2	RAS 25 TLM 33X2	25,15
30	S	M42X2	RAS 30 TLM M 42X2	46,37
38	S	M48X2	RAS 38 TLM M 48X2	62,30

Gas tube fittings

JIC 37° fittings

SAE Flanges

Clamps

Machines for  
processing rigid pipes

## Tubo rosca Métrica con tuerca y anillo

*Straight stud standpipe adaptor Metric cyl with nut and ring*

*Adapteur tube lisse x mâle Métrique avec écrou et bague*

*Adattatore diritto Metrico cilindrico con guarnizione*

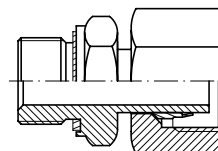

PIPE TUBO	SERIE	THREAD ROSCA	Part nº Referencia	€
6	L	M10X1	RAL 6 M 10X1 CTA	4,06
12	L	M16X1.5	RAL 12 M 16X1.5 CTA	5,43
15	L	M18X1.5	RAL 15 M 18X1.5 CTA	6,75
18	L	M22X1.5	RAL 18 M 22X1.5 CTA	8,65
35	L	M42X2	RAL 35 M 42X2 CTA	33,18
42	L	M48X2	RAL 42 M 48X2 CTA	42,89
6	S	M12X1.5	RAS 6 M 12X1.5 CTA	4,91
8	S	M14X1.5	RAS 8 M 14X1.5 CTA	6,14
14	S	M20X1.5	RAS 14 M 20X1.5 CTA	16,37
16	S	M22X1.5	RAS 16 M 22X1.5 CTA	14,21

Hasta fin de existencias. / Until end of stock. / Jusqu'à la fin du stock. / Fino ad esaurimento scorta.

# Racores DIN 2353

DIN 2353 Pipe fittings  
Raccords à bague DIN 2353  
Raccordi ad anello DIN 2353

## Tubo roscado recto BSP con tuerca y anillo

*Straight stud standpipe adaptor with captive seal BSP cyl with nut and ring*

*Adapteur tube lisse x mâle gaz + o'ring (avec écrou et bague)*

*Adattatore diritto BSP cilindrico con guarnizione*

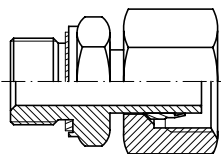

PIPE TUBO	SERIE	THREAD ROSCA	Part nº Referencia	€
6	L	1/8"BSP	<b>RAL 6 R 1/8 CTA</b>	<b>1,98</b>
8	L	1/4"BSP	<b>RAL 8 R 1/4 CTA</b>	<b>2,70</b>
10	L	1/4"BSP	<b>RAL 10 R 1/4 CTA</b>	<b>2,97</b>
12	L	3/8"BSP	<b>RAL 12 R 3/8 CTA</b>	<b>3,42</b>
15	L	1/2"BSP	<b>RAL 15 R 1/2 CTA</b>	<b>4,23</b>
18	L	1/2"BSP	<b>RAL 18 R 1/2 CTA</b>	<b>4,50</b>
22	L	3/4"BSP	<b>RAL 22 R 3/4 CTA</b>	<b>5,40</b>
35	L	1"1/4BSP	<b>RAL 35 R 1 1/4 CTA</b>	<b>18,90</b>
6	S	1/4"BSP	<b>RAS 6 R 1/4 CTA</b>	<b>2,52</b>
8	S	1/4"BSP	<b>RAS 8 R 1/4 CTA</b>	<b>2,70</b>
10	S	3/8"BSP	<b>RAS 10 R 3/8 CTA</b>	<b>3,24</b>
12	S	3/8"BSP	<b>RAS 12 R 3/8 CTA</b>	<b>3,60</b>
16	S	1/2"BSP	<b>RAS 16 R 1/2 CTA</b>	<b>4,68</b>
20	S	3/4"BSP	<b>RAS 20 R 3/4 CTA</b>	<b>7,02</b>
25	S	1"BSP	<b>RAS 25 R 1 CTA</b>	<b>12,60</b>
30	S	1"1/4BSP	<b>RAS 30 R 1 1/4 CTA</b>	<b>20,70</b>

Hasta fin de existencias. / Until end of stock. / Jusqu'à la fin du stock. / Fino ad esaurimento scorta.

## Tubo roscado recto BSP TLM con junta

*Straight stud standpipe adpt. w/captive seal&o'ring BSP cyl*

*Adapteur tube lisse x mâle gaz a/écrou+o'ring*

*Adattatore diritto BSP TLM*

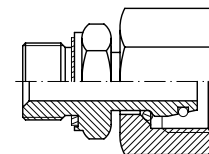

PIPE TUBO	SERIE	THREAD ROSCA	Part nº Referencia	€
6	L	1/8"BSP	<b>RAL 6 TLM R 1/8</b>	<b>1,98</b>
8	L	1/4"BSP	<b>RAL 8 TLM R 1/4</b>	<b>2,70</b>
10	L	1/4"BSP	<b>RAL 10 TLM R 1/4</b>	<b>2,97</b>
12	L	3/8"BSP	<b>RAL 12 TLM R 3/8</b>	<b>3,42</b>
15	L	1/2"BSP	<b>RAL 15 TLM R 1/2</b>	<b>4,23</b>
18	L	1/2"BSP	<b>RAL 18 TLM R 1/2</b>	<b>4,50</b>
22	L	3/4"BSP	<b>RAL 22 TLM R 3/4</b>	<b>5,40</b>
28	L	1"BSP	<b>RAL 28 TLM R 1</b>	<b>9,90</b>
35	L	1"1/4BSP	<b>RAL 35 TLM R 1 1/4</b>	<b>18,90</b>
42	L	1"1/2 BSP	<b>RAL 42 TLM R 1 1/2</b>	<b>27,00</b>
6	S	1/4"BSP	<b>RAS 6 TLM R 1/4</b>	<b>2,52</b>
8	S	1/4"BSP	<b>RAS 8 TLM R 1/4</b>	<b>2,70</b>
10	S	3/8"BSP	<b>RAS 10 TLM R 3/8</b>	<b>3,24</b>
12	S	3/8"BSP	<b>RAS 12 TLM R 3/8</b>	<b>3,60</b>
14	S	1/2"BSP	<b>RAS 14 TLM R 1/2</b>	<b>4,23</b>
16	S	1/2"BSP	<b>RAS 16 TLM R 1/2</b>	<b>4,68</b>
20	S	3/4"BSP	<b>RAS 20 TLM R 3/4</b>	<b>7,02</b>
25	S	1"BSP	<b>RAS 25 TLM R 1</b>	<b>12,60</b>
30	S	1"1/4BSP	<b>RAS 30 TLM R 1 1/4</b>	<b>20,70</b>
38	S	1"1/2BSP	<b>RAS 38 TLM R 1 1/2</b>	<b>30,60</b>



# Racores DIN 2353

DIN 2353 Pipe fittings  
Raccords à bague DIN 2353  
Raccordi ad anello DIN 2353

## Racor recto para soldar

Weldable straight coupling

Mamelon hexagonal à souder Métrique (DIN 2353) équipé avec bague et écrou

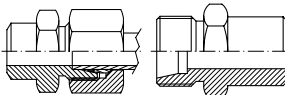

Raccordo diritto a saldare

PIPE TUBO	SERIE	Part n° Referencia	€	Part N° STA Referencia STA	€
6	L	ASL 6	1,72	STA ASL 6	1,05
8	L	ASL 8	1,75	STA ASL 8	1,11
10	L	ASL 10	2,06	STA ASL 10	1,26
12	L	ASL 12	2,28	STA ASL 12	1,37
15	L	ASL 15	2,84	STA ASL 15	1,57
18	L	ASL 18	3,89	STA ASL 18	2,10
22	L	ASL 22	5,79	STA ASL 22	3,36
28	L	ASL 28	9,21	STA ASL 28	5,56
35	L	ASL 35	14,07	STA ASL 35	8,40
42	L	ASL 42	20,93	STA ASL 42	12,60
6	S	ASS 6	8,65	STA ASS 6	7,73
8	S	ASS 8	9,22	STA ASS 8	8,26
10	S	ASS 10	4,66	STA ASS 10	3,63
12	S	ASS 12	5,74	STA ASS 12	4,57
14	S	ASS 14	3,70	STA ASS 14	2,03
16	S	ASS 16	4,47	STA ASS 16	2,52
20	S	ASS 20	6,22	STA ASS 20	3,68
25	S	ASS 25	11,51	STA ASS 25	6,82
30	S	ASS 30	16,35	STA ASS 30	9,45
38	S	ASS 38	22,31	STA ASS 38	13,26

## Boquilla para soldar

Welding nipple

Collet cône Métrique (DIN 2353) à souder (BW) o'ring

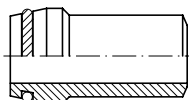

Ogiva a saldare

PIPE TUBO	SERIE	Part n° Referencia	€
15	L	ORIL 15	3,42
18	L	ORIL 18	3,98
22	L	ORIL 22	4,17
28	L	ORIL 28	5,24
8	S	ORIS 8X1.5	1,17
10	S	ORIS 10X2	1,27
12	S	ORIS 12X2.5	1,45
14	S	ORIS 14X2	4,68
14	S	ORIS 14X3	6,50
16	S	ORIS 16X2	4,56
16	S	ORIS 16X2.5	4,56
16	S	ORIS 16X3	2,50
20	S	ORIS 20X2.5	5,66
20	S	ORIS 20X3	5,66
20	S	ORIS 20X4	2,62
25	S	ORIS 25X4	3,59
30	S	ORIS 30X4	8,50
30	S	ORIS 30X5	5,05
38	S	ORIS 38X5	8,25

## Racor pasatabique para soldar

Weldable bulkhead coupling

Union double passe cloison Métrique à souder

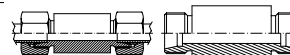

Raccordo passaparete a saldare

PIPE TUBO	SERIE	Part n° Referencia	€	Part N° STA Referencia STA	€
6	L	ESVL 6	14,83	STA ESVL 6	13,17
8	L	ESVL 8	14,49	STA ESVL 8	12,88
10	L	ESVL 10	17,95	STA ESVL 10	15,95
12	L	ESVL 12	16,36	STA ESVL 12	14,20
15	L	ESVL 15	22,05	STA ESVL 15	19,04
18	L	ESVL 18	26,36	STA ESVL 18	22,22
22	L	ESVL 22	25,72	STA ESVL 22	20,44
28	L	ESVL 28	28,42	STA ESVL 28	20,83
35	L	ESVL 35	44,44	STA ESVL 35	32,63
42	L	ESVL 42	59,22	STA ESVL 42	42,03
6	S	ESVS 6	15,31	STA ESVS 6	13,53
8	S	ESVS 8	18,31	STA ESVS 8	16,40
10	S	ESVS 10	16,87	STA ESVS 10	14,60
12	S	ESVS 12	19,42	STA ESVS 12	16,85
14	S	ESVS 14	26,72	STA ESVS 14	22,82
16	S	ESVS 16	23,83	STA ESVS 16	19,51
20	S	ESVS 20	25,34	STA ESVS 20	19,88
25	S	ESVS 25	38,28	STA ESVS 25	28,47
30	S	ESVS 30	49,82	STA ESVS 30	35,53
38	S	ESVS 38	63,52	STA ESVS 38	44,87

# Racores DIN 2353

DIN 2353 Pipe fittings  
Raccords à bague DIN 2353  
Raccordi ad anello DIN 2353

## Racor recto pasatabiques con tuerca

*Straight bulkhead coupling*

Union double passe cloison

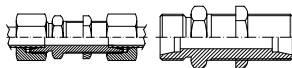

*Raccordo passaparete*

PIPE TUBO	SERIE	Part nº Referencia	€	Part Nº STA Referencia STA	€
6	6	L SVL 6	3,12	STA SVL 6	1,80
8	8	L SVL 8	3,54	STA SVL 8	2,25
10	10	L SVL 10	4,31	STA SVL 10	2,70
12	12	L SVL 12	5,15	STA SVL 12	3,33
15	15	L SVL 15	7,10	STA SVL 15	4,51
18	18	L SVL 18	10,18	STA SVL 18	6,51
22	22	L SVL 22	13,85	STA SVL 22	8,93
28	28	L SVL 28	19,41	STA SVL 28	12,07
35	35	L SVL 35	31,38	STA SVL 35	19,95
42	42	L SVL 42	46,21	STA SVL 42	29,40
6	6	S SVS 6	4,18	STA SVS 6	2,73
8	8	S SVS 8	4,45	STA SVS 8	2,94
10	10	S SVS 10	5,45	STA SVS 10	3,51
12	12	S SVS 12	6,92	STA SVS 12	4,73
14	14	S SVS 14	9,70	STA SVS 14	6,30
16	16	S SVS 16	11,10	STA SVS 16	7,14
20	20	S SVS 20	16,36	STA SVS 20	11,16
25	25	S SVS 25	27,34	STA SVS 25	17,85
30	30	S SVS 30	35,94	STA SVS 30	22,05
38	38	S SVS 38	81,44	STA SVS 38	62,27

## Racor en codo pasatabiques con tuerca

*Elbow bulkhead coupling*

Coude égal passe cloison

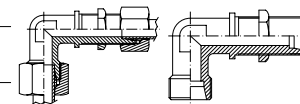

*Raccordo passaparete a 90°*

PIPE TUBO	SERIE	Part nº Referencia	€	Part Nº STA Referencia STA	€
6	17	L USVL 6	6,50	STA USVL 6	5,07
8	19	L USVL 8	6,41	STA USVL 8	5,04
10	22	L USVL 10	7,47	STA USVL 10	5,77
12	24	L USVL 12	9,29	STA USVL 12	7,35
15	27	L USVL 15	10,57	STA USVL 15	7,88
18	32	L USVL 18	13,21	STA USVL 18	9,45
22	36	L USVL 22	17,63	STA USVL 22	12,60
28	42	L USVL 28	30,26	STA USVL 28	22,62
35	50	L USVL 35	40,56	STA USVL 35	28,86
42	60	L USVL 42	66,54	STA USVL 42	49,14
8	22	S USVS 8	8,04	STA USVS 8	6,82
10	24	S USVS 10	8,43	STA USVS 10	6,40
12	27	S USVS 12	9,69	STA USVS 12	7,41
14	27	S USVS 14	10,78	STA USVS 14	7,35
16	30	S USVS 16	14,02	STA USVS 16	9,98
20	36	S USVS 20	18,92	STA USVS 20	13,65
25	42	S USVS 25	34,66	STA USVS 25	24,96
30	50	S USVS 30	45,36	STA USVS 30	31,20
38	60	S USVS 38	77,56	STA USVS 38	58,50

## Tuerca pasatabiques Métrica

*Metric nut bulkhead*

Ecrou passe cloison Métrique

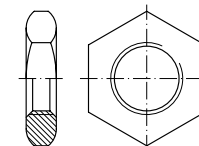

*Dado passaparete Metrico*

THREAD ROSCA	Part nº Referencia	€
M 12x1,5	TP 06 L	0,43
M 14x1,5	TP 08 L	0,61
M 16x1,5	TP 10 L	0,62
M 18x1,5	TP 12 L	0,62
M 22x1,5	TP 15 L	0,95
M 26x1,5	TP 18 L	1,24
M 30x2	TP 22 L	1,70
M 36x2	TP 28 L	1,80
M45x2	TP 35 L	2,16
M 52x2	TP 42 L	4,18
M 20x1,5	TP 12 S	0,79
M 24x1,5	TP 16 S	1,14
M 42x2	TP 30 S	2,16

# Racores DIN 2353

DIN 2353 Pipe fittings  
Raccords à bague DIN 2353  
Raccordi ad anello DIN 2353

## Racor recto hembra rosca BSP

Female stud coupling

Union simple femelle gaz

Raccordo diritto femmina BSP

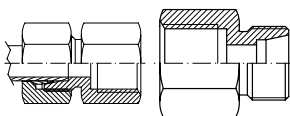

T.	S.	THREAD ROSCA	Part n° Referencia	€	Part N° STA Referencia STA	€
6	L	1/8" BSP	GAIL 6 R 1/8	2,15	STA GAIL 6 R 1/8	1,47
8	L	1/4" BSP	GAIL 8 R 1/4	2,23	STA GAIL 8 R 1/4	1,57
10	L	1/4" BSP	GAIL 10 R 1/4	2,38	STA GAIL 10 R 1/4	1,57
10	L	3/8" BSP	GAIL 10 R 3/8	2,77	STA GAIL 10 R 3/8	1,95
10	L	1/2" BSP	GAIL 10 R 1/2	21,05	STA GAIL 10 R 1/2	19,70
12	L	3/8" BSP	GAIL 12 R 3/8	2,86	STA GAIL 12 R 3/8	1,94
12	L	1/2" BSP	GAIL 12 R 1/2	3,67	STA GAIL 12 R 1/2	2,73
15	L	1/2" BSP	GAIL 15 R 1/2	3,63	STA GAIL 15 R 1/2	2,34
18	L	1/2" BSP	GAIL 18 R 1/2	4,54	STA GAIL 18 R 1/2	2,73
22	L	3/4" BSP	GAIL 22 R 3/4	6,33	STA GAIL 22 R 3/4	3,88
28	L	1" BSP	GAIL 28 R 1	9,97	STA GAIL 28 R 1	6,30
35	L	1 1/4" BSP	GAIL 35 R 1 1/4	37,02	STA GAIL 35 R 1 1/4	30,68
42	L	1 1/2" BSP	GAIL 42 R 1 1/2	45,73	STA GAIL 42 R 1 1/2	36,67
6	S	1/4" BSP	GAIS 6 R 1/4	2,67	STA GAIS 6 R 1/4	1,93
8	S	1/4" BSP	GAIS 8 R 1/4	2,70	STA GAIS 8 R 1/4	1,93
10	S	3/8" BSP	GAIS 10 R 3/8	4,13	STA GAIS 10 R 3/8	3,12
14	S	1/2" BSP	GAIS 14 R 1/2	4,85	STA GAIS 14 R 1/2	3,15
16	S	1/2" BSP	GAIS 16 R 1/2	5,12	STA GAIS 16 R 1/2	3,15
20	S	3/4" BSP	GAIS 20 R 3/4	7,84	STA GAIS 20 R 3/4	5,25
25	S	1" BSP	GAIS 25 R 1	12,04	STA GAIS 25 R 1	7,35
30	S	1 1/4" BSP	GAIS 30 R 1 1/4	39,24	STA GAIS 30 R 1 1/4	31,68
38	S	1 1/2" BSP	GAIS 38 R 1 1/2	52,55	STA GAIS 38 R 1 1/2	42,62

## Arandela para manómetros

Seal for gauge coupling

Bague pour manomètres

Guarnizioni per manometri

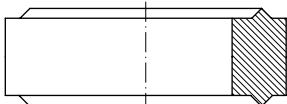

THREAD ROSCA	Part n° Referencia	€
1/4" BSP	AM 1/4	1,40
1/2" BSP	AM 1/2	1,44

## Racor recto hembra rosca Métrica

Female stud coupling Metric cyl

Union simple femelle Métrique

Raccordo diritto femmina Metrico

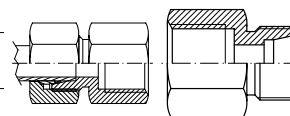

T.	S.	THREAD ROSCA	Part n° Referencia	€	Part N° STA Referencia STA	€
6	L	M10x1	GAIL 6 M 10X1	8,07	STA GAIL 6 M 10X1	7,22
8	L	M12x1,5	GAIL 8 M 12X1.5	8,73	STA GAIL 8 M 12X1.5	7,89
10	L	M14X1.5	GAIL 10 M14X1.5	9,52	STA GAIL 10 M 14X1.5	8,50
12	L	M16X1.5	GAIL 12 M16X1.5	10,46	STA GAIL 12 M 16X1.5	9,32
15	L	M18X1.5	GAIL 15 M18X1.5	11,79	STA GAIL 15 M 18X1.5	10,26
16	S	M22x1,5	GAIS 16 M 22X1.5	15,06	STA GAIS 16 M 22X1.5	12,80
18	L	M22X1.5	GAIL 18 M22X1.5	14,77	STA GAIL 18 M 22X1.5	12,65
22	L	M26X1.5	GAIL 22 M26X1.5	16,16	STA GAIL 22 M 26X1.5	13,42
6	S	M12x1,5	GAIS 6 M 12X1.5	8,86	STA GAIS 6 M 12X1.5	7,94
8	S	M14x1,5	GAIS 8 M 14X1.5	9,52	STA GAIS 8 M 14X1.5	8,55
10	S	M16X1.5	GAIS 10 M16X1.5	10,57	STA GAIS 10 M 16X1.5	9,37
12	S	M18X1.5	GAIS 12 M18X1.5	11,38	STA GAIS 12 M 18X1.5	10,05
14	S	M20X1.5	GAIS 14 M20X1.5	12,85	STA GAIS 14 M 20X1.5	10,91
20	S	M27x2	GAIS 20 M 27X2	17,92	STA GAIS 20 M 27X2	15,04

## Racor para manómetro BSP

Gauge coupling BSP cyl

Union pour manomètre gaz

Raccordo per manometri BSP

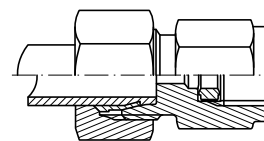

PIPE TUBO	SERIE	THREAD ROSCA	Part n° Referencia	€
6	L	1/4" BSP	MAVL 6 R 1/4	2,19
8	L	1/4" BSP	MAVL 8 R 1/4	2,17
10	L	1/4" BSP	MAVL 10 R 1/4	2,31
12	L	1/4" BSP	MAVL 12 R 1/4	2,41
6	S	1/2" BSP	MAVS 6 R 1/2	6,90
8	S	1/2" BSP	MAVS 8 R 1/2	7,04
10	S	1/2" BSP	MAVS 10 R 1/2	7,31
12	S	1/2" BSP	MAVS 12 R 1/2	7,51

# Racores DIN 2353

DIN 2353 Pipe fittings  
Raccords à bague DIN 2353  
Raccordi ad anello DIN 2353

## Racor en codo orientable sin estrangulador rosca BSP

Elbow banjo coupling with captive seal and o-ring  
BSP cyl

Equerre orientable sans étrangleur gaz BSP  
(passage total)

Raccordo orientabile a 90° ad occhio BSP con  
guarnizione

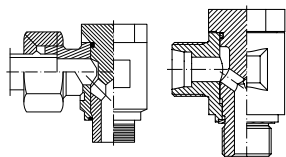

T.	S.	THREAD ROSCA	Part nº Referencia	€	Part Nº STA Referencia STA	€
6	LL	1/8" BSP	WSVLL 6 R 1/8	9,01	STA WSVLL 6 R 1/8	8,19
8	LL	1/8" BSP	WSVLL 8 R 1/8	9,11	STA WSVLL 8 R 1/8	8,20
6	L	1/8" BSP	WSVL 6 R 1/8	9,80	STA WSVL 6 R 1/8	8,90
8	L	1/4" BSP	WSVL 8 R 1/4	11,21	STA WSVL 8 R 1/4	10,29
10	L	1/4" BSP	WSVL 10 R 1/4	8,83	STA WSVL 10 R 1/4	7,83
12	L	3/8" BSP	WSVL 12 R 3/8	11,28	STA WSVL 12 R 3/8	10,11
15	L	1/2" BSP	WSVL 15 R 1/2	21,57	STA WSVL 15 R 1/2	19,75
18	L	1/2" BSP	WSVL 18 R 1/2	24,35	STA WSVL 18 R 1/2	21,96
22	L	3/4" BSP	WSVL 22 R 3/4	33,79	STA WSVL 22 R 3/4	30,55
28	L	1" BSP	WSVL 28 R 1	70,48	STA WSVL 28 R 1	65,04
35	L	1 1/4" BSP	WSVL 35 R 1 1/4	116,61	STA WSVL 35 R 1 1/4	107,95
42	L	1 1/2" BSP	WSVL 42 R 1 1/2	149,57	STA WSVL 42 R 1 1/2	137,48
6	S	1/4" BSP	WSVS 6 R 1/4	11,94	STA WSVS 6 R 1/4	10,93
8	S	1/4" BSP	WSVS 8 R 1/4	11,98	STA WSVS 8 R 1/4	10,94
10	S	3/8" BSP	WSVS 10 R 3/8	15,20	STA WSVS 10 R 3/8	13,87
12	S	3/8" BSP	WSVS 12 R 3/8	16,52	STA WSVS 12 R 3/8	15,05
14	S	1/2" BSP	WSVS 14 R 1/2	21,71	STA WSVS 14 R 1/2	19,52
16	S	1/2" BSP	WSVS 16 R 1/2	21,13	STA WSVS 16 R 1/2	18,69
20	S	3/4" BSP	WSVS 20 R 3/4	33,62	STA WSVS 20 R 3/4	30,28
25	S	1" BSP	WSVS 25 R 1	71,47	STA WSVS 25 R 1	65,04
30	S	1 1/4" BSP	WSVS 30 R 1 1/4	117,80	STA WSVS 30 R 1 1/4	107,95
38	S	1 1/2" BSP	WSVS 38 R 1 1/2	150,26	STA WSVS 38 R 1 1/2	137,48

## Racor en codo orientable sin estrangulador rosca Métrica

Elbow banjo coupling with captive seal and o'ring  
metric cyl

Equerre orientable sans étrangleur métrique  
(passage total)

Raccordo orientabile a 90° ad occhio Metrico con  
guarnizione

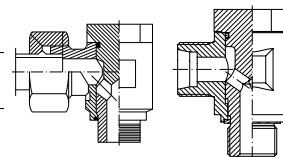

T.	S.	THREAD ROSCA	Part nº Referencia	€	Part Nº STA Referencia STA	€
6	LL	M10X1	WSVLL 6 M 10X1	10,12	STA WSVLL 6 M 10X1	9,27
8	LL	M10X1	WSVLL 8 M 10X1	10,22	STA WSVLL 8 M 10X1	9,27
6	L	M10X1	WSVL 6 M 10X1	10,19	STA WSVL 6 M 10X1	9,27
8	L	M12X1.5	WSVL 8 M 12X1.5	13,29	STA WSVL 8 M 12X1.5	12,31
10	L	M14X1.5	WSVL 10 M 14X1.5	13,44	STA WSVL 10 M 14X1.5	12,31
12	L	M16X1.5	WSVL 12 M 16X1.5	18,11	STA WSVL 12 M 16X1.5	16,74
15	L	M18X1.5	WSVL 15 M 18X1.5	23,10	STA WSVL 15 M 18X1.5	21,24
18	L	M22X1.5	WSVL 18 M 22X1.5	25,70	STA WSVL 18 M 22X1.5	23,27
22	L	M26X1.5	WSVL 22 M 26X1.5	45,46	STA WSVL 22 M 26X1.5	41,88
28	L	M33X2	WSVL 28 M 33X2	82,38	STA WSVL 28 M 33X2	76,59
35	L	M42X2	WSVL 35 M 42X2	130,50	STA WSVL 35 M 42X2	121,44
42	L	M48X2	WSVL 42 M 48X2	167,26	STA WSVL 42 M 48X2	154,66
8	S	M14X1.5	WSVS 8 M 14X1.5	13,41	STA WSVS 8 M 14X1.5	12,33
10	S	M16X1.5	WSVS 10 M 16X1.5	18,18	STA WSVS 10 M 16X1.5	16,76
12	S	M18X1.5	WSVS 12 M 18X1.5	22,91	STA WSVS 12 M 18X1.5	21,24
14	S	M20X1.5	WSVS 14 M 20X1.5 *	25,39	STA WSVS 14 M 20X1.5	23,09
16	S	M22X1.5	WSVS 16 M 22X1.5	25,83	STA WSVS 16 M 22X1.5	23,27
20	S	M27X2	WSVS 20 M 27X2	45,59	STA WSVS 20 M 27X2	41,90
25	S	M33X2	WSVS 25 M 33X2	79,89	STA WSVS 25 M 33X2	73,21
30	S	M42X2	WSVS 30 M 42X2	131,70	STA WSVS 30 M 42X2	121,44
38	S	M48x2	WSVS 38 M 48X2	167,95	STA WSVS 38 M 48X2	154,66

\*Hasta fin de existencias. / \*Until end of stock. / \*Jusqu'à la fin du stock. / \*Fino ad esaurimento scorta.

## Racor en codo orientable BSP-Métrico

90° Adjustable male stud elbow BSP - Metric

CoUDE réglable mâle BSP - Métrique

Raccordo a 90° orientabile maschio BSP-Metrico

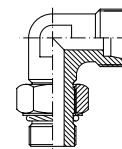

PIPE TUBO	SERIE	THREAD ROSCA		Part nº Referencia	€
6	L	M12X1,5	1/8" BSP	STA WEE 6L R 1/8	6,57
8	L	M14X1,5	1/4" BSP	STA WEE 8L R 1/4	7,46
10	L	M16X1,5	1/4" BSP	STA WEE 10L R 1/4	7,46
12	L	M18X1,5	3/8" BSP	STA WEE 12L R 3/8	9,73
15	L	M22X1,5	1/2" BSP	STA WEE 15L R 1/2	12,84
18	L	M26X1,5	1/2" BSP	STA WEE 18L R 1/2	19,50
22	L	M30X2	3/4" BSP	STA WEE 22L R 3/4	25,36
16	S	M24X1,5	1/2" BSP	STA WEE 16S R 1/2	19,99
20	S	M30X2	3/4" BSP	STA WEE 20S R 3/4	23,80
25	S	1" BSP	M36X2	STA WEE 25S R 1	44,05

# Racores DIN 2353

DIN 2353 Pipe fittings  
Raccords à bague DIN 2353  
Raccordi ad anello DIN 2353

## Tapón de cierre para tubo

Blanking plug with o'ring

Bouchon de fermeture avec o'ring

Tappo di chiusura con o'ring

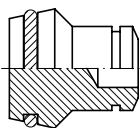

PIPE TUBO	SERIE	Part nº Referencia	€
6	L/S	BUTZEN L 6	0,58
8	L/S	BUTZEN L 8	0,68
10	L/S	BUTZEN L 10	0,78
12	L/S	BUTZEN L 12	0,97
15	L	BUTZEN L 15	1,68
18	L	BUTZEN L 18	1,27
22	L	BUTZEN L 22	1,75
28	L	BUTZEN L 28	2,43
35	L	BUTZEN L 35	4,47
42	L	BUTZEN L 42	7,28
14	S	BUTZEN S 14	1,41
16	S	BUTZEN S 16	1,17
20	S	BUTZEN S 20	1,45
25	S	BUTZEN S 25	2,23
30	S	BUTZEN S 30	3,40
38	S	BUTZEN S 38	5,72

## Tapón de cierre Allen rosca BSP con junta

Blanking plug with captive seal BSP cyl

Bouchon Allen gaz avec o'ring

Tappo cilindrico BSP esagono incassato con o'ring

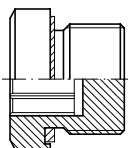

PIPE TUBO	THREAD ROSCA	Part nº Referencia	€
14	1/8" BSP	STOPFEN 1/8	0,83
19	1/4" BSP	STOPFEN 1/4	0,97
22	3/8" BSP	STOPFEN 3/8	1,07
27	1/2" BSP	STOPFEN 1/2	1,36
32	3/4" BSP	STOPFEN 3/4	1,75
40	1" BSP	STOPFEN 1	2,91
50	1"1/4 BSP	STOPFEN 1 1/4	4,85
55	1"1/2 BSP	STOPFEN 1 1/2	6,79
72	2" BSP	STOPFEN 2	17,47

## Tapón de cierre Allen rosca Métrica con junta

Blanking plug with captive seal Metric cyl

Bouchon Allen Métrique avec o'ring

Tappo cilindrico Metrico esagono incassato con guarnizione

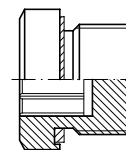

PIPE TUBO	THREAD ROSCA	Part nº Referencia	€
14	M10X1	STOPFEN M 10X1	0,87
17	M12X1.25	STOPFEN M 12X1.25	0,97
17	M12X1.5	STOPFEN M 12X1.5	0,97
19	M14X1.5	STOPFEN M 14X1.5	1,07
22	M16X1.5	STOPFEN M 16X1.5	1,17
24	M18X1.5	STOPFEN M 18X1.5	1,27
27	M22X1.5	STOPFEN M 22X1.5	1,36
32	M26X1.5	STOPFEN M 26X1.5	1,75
32	M27X2	STOPFEN M 27X2	1,75
40	M33X2	STOPFEN M 33X2	2,91
50	M42X2	STOPFEN M 42X2	6,79
55	M48X2	STOPFEN M 48X2	18,35

## Tapón

Plug

Bouchon

Tappo

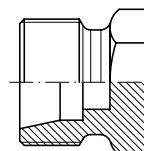

PIPE TUBO	SERIE	THREAD ROSCA	Part nº Referencia	€
6	L	12x1.5	STA TML 6	0,68
8	L	14x1.5	STA TML 8	0,78
10	L	16x1.5	STA TML 10	0,97
12	L	18x1.5	STA TML 12	1,07
15	L	22x1.5	STA TML 15	1,17
18	L	26x1.5	STA TML 18	1,45
22	L	30x2	STA TML 22	1,94
28	L	36x2	STA TML 28	3,20
35	L	45x2	STA TML 35	5,82
42	L	52x2	STA TML 42	25,70
6	S	14x1.5	STA TMS 6	0,87
8	S	16x1.5	STA TMS 8	1,48
10	S	18x1.5	STA TMS 10	0,97
12	S	20x1.5	STA TMS 12	1,17
14	S	22x1.5	STA TMS 14	1,45
16	S	24x1.5	STA TMS 16	1,75
20	S	30x2	STA TMS 20	2,62
25	S	36x2	STA TMS 25	4,47
30	S	42x2	STA TMS 30	7,28
38	S	52x2	STA TMS 38	11,64

# Racores DIN 2353

DIN 2353 Pipe fittings

Raccords à bague DIN 2353

Raccordi ad anello DIN 2353

## Antirretorno tubo-tubo

Non-return valve tube-tube

Clapet antiretour bidirectional tube-tube

Valvola di ritegno tubo-tubo

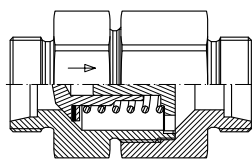

PIPE TUBO	SERIE	Part n° Referencia	€
6	L	RHDL 6	63,33
8	L	RHDL 8	63,69
10	L	RHDL 10	64,13
12	L	RHDL 12	75,61
15	L	RHDL 15	87,57
18	L	RHDL 18	89,65
22	L	RHDL 22	118,47
28	L	RHDL 28	125,38
35	L	RHDL 35	225,54
42	L	RHDL 42	234,72
6	S	RHDS 6	63,82
8	S	RHDS 8	64,13
10	S	RHDS 10	75,78
12	S	RHDS 12	76,48
14	S	RHDS 14	88,51
16	S	RHDS 16	89,94
20	S	RHDS 20	120,02
25	S	RHDS 25	132,08
30	S	RHDS 30	232,06
38	S	RHDS 38	246,76

## Antirretorno tubo - rosca BSP

Non-return valve flow towards male stud end BSP cyl

Clapet antiretour unidir. à droite tube-mâle BSP

Valvola di ritegno a destra

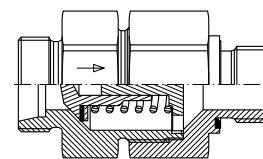

PIPE TUBO	SERIE	THREAD ROSCA	Part n° Referencia	€
6	L	1/8" BSP	RHZL 6 R 1/8	62,46
8	L	1/4" BSP	RHZL 8 R1/4	62,80
10	L	1/4" BSP	RHZL 10 R1/4	63,02
12	L	3/8" BSP	RHZL 12 R3/8	74,43
15	L	1/2" BSP	RHZL 15 R1/2	85,96
18	L	1/2" BSP	RHZL 18 R1/2	87,00
22	L	3/4" BSP	RHZL 22 R 3/4	114,84
28	L	1" BSP	RHZL 28 R1	119,01
35	L	1"1/4 BSP	RHZL 35 R1 1/4	216,50
42	L	1"1/2 BSP	RHZL 42 R1 1/2	222,20
6	S	1/4" BSP	RHZS 6 R 1/4	62,86
8	S	1/4" BSP	RHZS 8 R1/4	63,02
10	S	3/8" BSP	RHZS 10 R 3/8	74,52
12	S	3/8" BSP	RHZS 12 R3/8	74,87
14	S	1/2" BSP	RHZS 14 R 1/2	86,43
16	S	1/2" BSP	RHZS 16 R1/2	87,14
20	S	3/4" BSP	RHZS 20 R3/4	115,61
25	S	1" BSP	RHZS 25 R1	122,35
30	S	1"1/4 BSP	RHZS 30 R1 1/4	219,77
38	S	1"1/2 BSP	RHZS 38 R1 1/2	228,21

## Antirretorno rosca BSP - tubo

Non-return valve flow from male stud end BSP cyl

Clapet antiretour unidir. à gauche mâle BSP-tube

Valvola di ritegno a sinistra

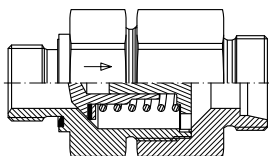

PIPE TUBO	SERIE	THREAD ROSCA	Part n° Referencia	€
6	L	1/8" BSP	RHVL 6 R1/8	62,46
8	L	1/4" BSP	RHVL 8 R 1/4	62,80
10	L	1/4" BSP	RHVL 10 R 1/4	63,02
12	L	3/8" BSP	RHVL 12 R3/8	74,43
15	L	1/2" BSP	RHVL 15 R 1/2	85,96
18	L	1/2" BSP	RHVL 18 R1/2	87,00
22	L	3/4" BSP	RHVL 22 R3/4	114,84
28	L	1" BSP	RHVL 28 R1	119,01
35	L	1"1/4 BSP	RHVL 35 R1 1/4	216,50
42	L	1"1/2 BSP	RHVL 42 R1 1/2	222,20
6	S	1/4" BSP	RHVS 6 R1/4	62,86
8	S	1/4" BSP	RHVS 8 R1/4	63,02
10	S	3/8" BSP	RHVS 10 R3/8	74,52
12	S	3/8" BSP	RHVS 12 R3/8	74,87
14	S	1/2" BSP	RHVS 14 R 1/2	86,43
16	S	1/2" BSP	RHVS 16 R1/2	87,14
20	S	3/4" BSP	RHVS 20 R3/4	115,61
25	S	1" BSP	RHVS 25 R1	122,35
30	S	1"1/4 BSP	RHVS 30 R1 1/4	219,77
38	S	1"1/2 BSP	RHVS 38 R 1 1/2	228,21

# LA CALIDAD SIEMPRE ES LO PRIMERO

QUALITY ALWAYS COMES FIRST

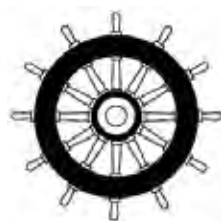

- |  |  |
|--|--|
| <p>✓ Análisis espectrográfico de materiales - Emisión de certificados de materia prima.</p>                | <p>✓ Spectrographic analysis of material - certificate issuance of raw material.</p> |
| <p>✓ Validación de los nuevos diseños de Oficina Técnica.</p>  | <p>✓ Validation of new designs by Technical Department.</p>                          |
| <p>✓ Gestión de reclamaciones de clientes - ensayos en bancos de prueba, control dimensional.</p>          | <p>✓ Handling of customer claims - testing by dimensional control, test benches.</p> |
| <p>✓ Emisión de certificados de prueba (presión, estanqueidad, dureza, resistencia a la corrosión...).</p> | <p>✓ Test certificate issuance (pressure, tightness, hardness, corrosion).</p>       |
| <p>✓ Sistema de gestión de calidad total de productos y servicios prestados.</p>                           | <p>✓ Global system of quality control over the products and services.</p>            |
| <p>✓ Emisión de certificados: EN 10204.</p>  | <p>✓ Certificate issuance: EN 10204.</p>   |



## Racores para tubo gas

*Gas tube fittings*

Raccords tube gaz

*Raccordi per tubo gas*

## Racores para tubo gas

*Gas tube fittings*

Raccords tube gaz

*Raccordi per tubo gas*

203



3

# Racores para tubo gas

Gas tube fittings  
Raccords tube gaz  
Raccordi per tubo gas

## Tuercas y anillos / Nuts and cutting rings / Écrous et bagues / Dadi e anelli

| 203

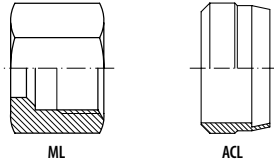

ML

ACL

## Uniones tubo-tubo / Straight couplings / Unions doubles / Raccordi intermedi

| 203

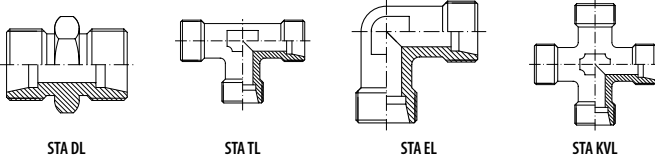

STA DL

STA TL

STA EL

STA KVL

## Uniones tubo-rosca / Male stud couplings / Unions simples mâle / Raccordi di estremità

| 203

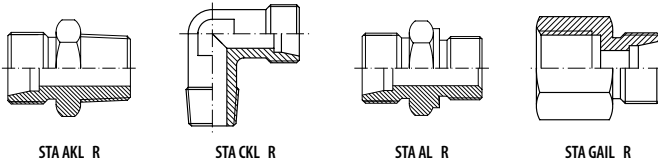

STA AKL R

STA CKL R

STA AL R

STA GAIL R

# Racores para tubo gas

Gas tube fittings  
Raccords tube gaz  
Raccordi per tubo gas

## Tuercas gas

Nut gas

Écrou gaz

Dado gas

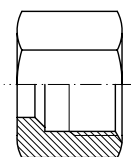

PIPE TUBO	THREAD ROSCA	Part nº Referencia	€
1/4" - 13.2	20X1,5	ML 13.2	5,80
3/8" - 16.7	24X1,5	ML 16.7	7,73
1/2" - 21.3	30X1,5	ML 21.3	11,65
1" - 33.5	45X1,5	ML 33.5	31,21
1" 1/4 - 42.4	52X1,5	ML 42.4	65,65

## Anillo tubo gas

Cutting ring gas

Bague tube gaz

Anello tubo-gas



PIPE TUBO	Part nº Referencia	€
1/4" - 13.2	ACL 13.2	1,66
3/8" - 16.7	ACL 16.7	2,43
1/2" - 21.3	ACL 21.3	3,46
1" 1/4 - 42.4	ACL 42.4	14,08

## Unión recta tubo-tubo

Straight coupling

Union double

Raccordo tubo-tubo

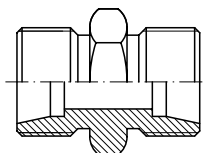

PIPE TUBO	SERIE	Part nº Referencia	€
21.3	L	STA DL 21.3	20,06
26.7	L	STA DL 26.7	24,55

## Unión en T tubo-tubo

Equal TEE

Té égal

Raccordo a T tubo-tubo

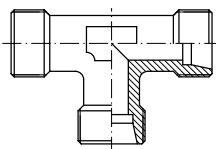

PIPE TUBO	SERIE	Part nº Referencia	€
13.2	L	STA TL 13.2	21,36
21.3	L	STA TL 21.3	40,38
33.5	L	STA TL 33.5	137,28

## Unión recta tubo-rosca cónica BSPT

Straight male stud coupling tapered

Union mâle gaz conique

Raccordo diritto conico per tubo gas

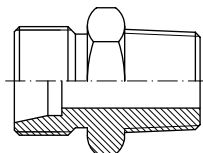

PIPE TUBO	SERIE	THREAD ROSCA	Part nº Referencia	€
13.2	L	1/2" BSPT	STA AKL 13.2 R 1/2	9,35
16.7	L	3/8" BSPT	STA AKL 16.7 R 3/8	10,21
21.3	L	1/2" BSPT	STA AKL 21.3 R 1/2	15,29
21.3	L	3/4" BSPT	STA AKL 21.3 R 3/4	15,29
42.4	L	1" 1/4 BSPT	STA AKL 42.4 R 1 1/4	108,46

## Unión en codo tubo-tubo

Equal elbow coupling

CoUDE égal

Raccordo a 90° tubo-tubo

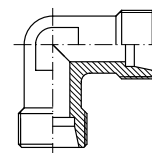

PIPE TUBO	SERIE	Part nº Referencia	€
13.2	L	STA EL 13.2	16,95
16.7	L	STA EL 16.7	19,74
21.3	L	STA EL 21.3	32,38
26.7	L	STA EL 26.7	52,43
33.5	L	STA EL 33.5	108,19

## Unión en cruz tubo-tubo

Equal cross

Croix égale

Raccordo a croce tubo-tubo

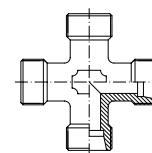

PIPE TUBO	SERIE	Part nº Referencia	€
16.7	L	STA KVL 16.7	79,73

## Unión en codo tubo-rosca cónica BSPT

Male stud elbow BSPT

CoUDE mâle gaz conique

Raccordo a 90° conico per tubo gas

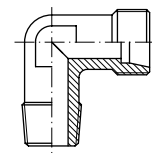

PIPE TUBO	SERIE	THREAD ROSCA	Part nº Referencia	€
13,2	L	1/2" BSPT	STA CKL 13.2 R 1/2	16,14
13.2	L	3/8" BSPT	STA CKL 13.2 R 3/8	16,41
16.7	L	3/8" BSPT	STA CKL 16.7 R 3/8	20,01
42.4	L	1" 1/4 BSPT	STA CKL 42.4 R 1 1/4	296,60

# Racores para tubo gas

Gas tube fittings  
Raccords tube gaz  
Raccordi per tubo gas

## Unión recta tubo-rosca cilíndrica BSP

*Straight male stud coupling cyl*

*Union mâle gaz cyl*

*Raccordo diritto cilindrico per tubo gas*

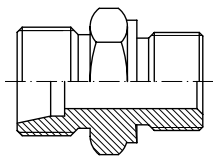

PIPE TUBO	SERIE	THREAD ROSCA	Part n° Referencia	€
13.2	L	1/4" BSP	STA AL 13.2 R 1/4	<b>7,96</b>
21.3	L	1/2" BSP	STA AL 21.3 R 1/2	<b>15,78</b>
42.4	L	1"1/4 BSP	STA AL 42.4 R 1 1/4	<b>93,53</b>
42.4	L	1"1/2 BSP	STA AL 42.4 R 1 1/2	<b>117,18</b>

## Unión recta tubo-hembra fija BSP

*Female stud coupling gas*

*Union femelle gaz cyl*

*Raccordo diritto femmina per tubo gas*

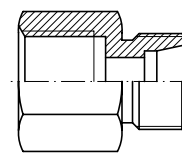

PIPE TUBO	SERIE	THREAD ROSCA	Part n° Referencia	€
13.2	L	3/8" BSP	STA GAIL 13.2 R 3/8	<b>16,37</b>

# ATENCIÓN



# WARNING

UNA CORRECTA LUBRICACIÓN  
GARANTIZA EL BUEN  
FUNCIONAMIENTO DE LAS ROSCAS

A CORRECT LUBRICATION  
GUARANTEES YOU A CORRECT  
PERFORMANCE OF THE THREADS

**NO LO OLVIDE · DO NOT FORGET IT**



**NE L'OUBLIEZ PAS · NON DIMENTICATELO**

UNE CORRECTE LUBRICATION  
VOUS GARANTIT L'UTILISATION  
CORRECTE DES FILETAGES

UNA CORRETTA LUBRIFICAZIONE VI  
GARANTISCE UN CORRETTO  
UTILIZZO DELLE FILETTATURE

# ATTENTION



# ATTENZIONE

## Racores JIC 37°

*JIC 37° fittings*

Raccords JIC 37°

*Raccordi JIC 37°*

## Racores JIC 37°

*JIC 37° fittings*

Raccords JIC 37°

*Raccordi JIC 37°*

210

4

# Racores JIC 37°

JIC 37° fittings

Raccords JIC 37°

Raccordi JIC 37°

## Tuercas y férulas JIC 37° / Nuts and Sleeves / Écrous et Férules JIC 37° / Dadi e Bussole JIC 37°

| 210

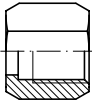

S110

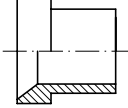

S120

## Tapones JIC 37° / JIC 37° Plugs / Bouchons JIC 37° / Tappi JIC 37°

| 210



S130

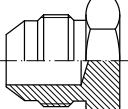

S140

## Uniones rectas JIC 37° / JIC 37° Straight union / Unions droites JIC 37° / Adattatori diritti JIC 37°

| 211

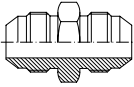

S260

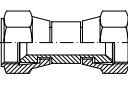

S730

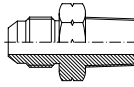

S200

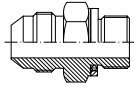

S230

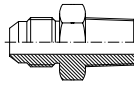

S210

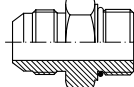

S220



S740

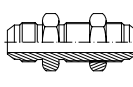

S250

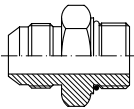

S240



S160

## Uniones macho-hembra JIC 37° / JIC 37° Male-female unions / Unions mâle JIC 37° x femelle JIC 37° / Adattatori maschio-femmina JIC 37°

| 213

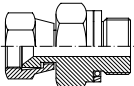

S180

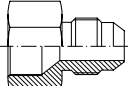

S290

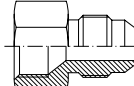

S280

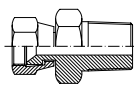

S150



S215

## Codos JIC 37° / JIC 37° Elbows / Coudes JIC 37° / Adattatori a 45° e 90° JIC 37°

| 214

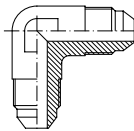

S500

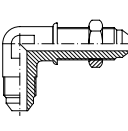

S650

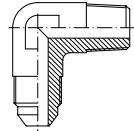

S550

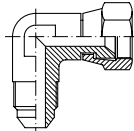

S675

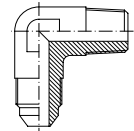

S525

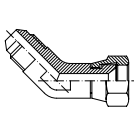

S690

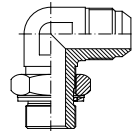

S600

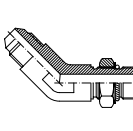

S615

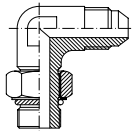

S575

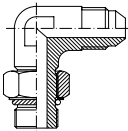

S625



S665



S590

## Tes y Cruz JIC 37° / JIC 37° Tees and Crosses / Tés et Croix JIC 37° / Adattatori a T e Croci JIC 37°

| 217

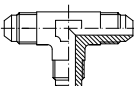

S505

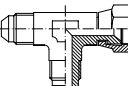

S680

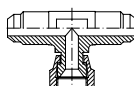

S685



# Racores JIC 37°

JIC 37° fittings  
Raccords JIC 37°  
Raccordi JIC 37°

■ Tes orientable JIC 37° / JIC 37° Banjo Tees / Tés orientables JIC 37° / Adattatori a T orientabili

218

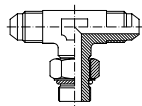

S610

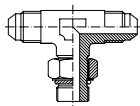

S585

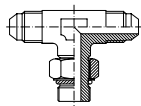

S635

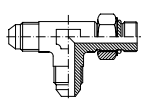

S605

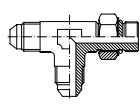

S580

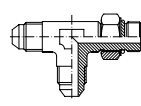

S630



S670



S681



S695

Pipe

DIN 2353 Pipe Fittings

Gas tube fittings

JIC 37° fittings

SAE Flanges

Clamps

Machines for processing rigid pipes

# Racores JIC 37°

JIC 37° fittings

Raccords JIC 37°

Raccordi JIC 37°

## Tuercas JIC 37°

JIC 37° Nuts

Écrous JIC 37°

Dado JIC 37°

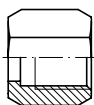

PIPE TUBO		THREAD ROSCA	Part n° Referencia	€
6	1/4	7/16" 20h UNF	S11006	0,55
8	5/16	1/2" 20h UNF	S11008	0,62
10	3/8	9/16" 18h UNF	S11010	0,67
12	1/2	3/4" 16h UNF	S11012	0,83
14-15-16	5/8	7/8" 14h UNF	S11016	1,41
18-20	-	1"1/16 12h UNF	S11020	2,95
-	3/4	1"1/16 12h UNF	S11020W	2,83
25	1	1"5/16 12h UNF	S11025	3,86
30-32	1 1/4	1"5/8 12h UNF	S11032	8,68
38	1 1/2	1"7/8 12h UNF	S11038	13,43

## Férulas JIC 37° (Tubo Métrico)

JIC 37° sleeves Metric tube

Férules JIC 37° pour tube Métrique

Bussola JIC 37° (tubo Metrico)

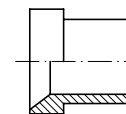

PIPE TUBO		Part n° Referencia	€
6		S12006	0,43
8		S12008	0,46
10		S12010	0,46
12		S12012	0,57
14		S12014	0,91
15		S12015	0,88
16		S12016	0,74
18		S12018	1,26
20		S12020	1,26
25		S12025	1,92
30		S12030	4,90
32		S12032	3,99
38		S12038	6,52

## Tapón hembra JIC 37°

37° JIC Female plug

Obturbateur femelle JIC 37° pour raccord

Tappo femmina girevole JIC 37°

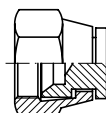

PIPE TUBO		THREAD ROSCA	Part n° Referencia	€
6		7/16" 20h UNF	S13006	1,48
8		1/2" 20h UNF	S13008	1,82
10		9/16" 18h UNF	S13010	2,22
12		3/4" 16h UNF	S13012	2,55
14-15-16		7/8" 14h UNF	S13016	3,80
18-20		1"1/16 12h UNF	S13020	5,28
25		1"5/16 12h UNF	S13025	8,98
30-32		1"5/8 12h UNF	S13032	15,31
38		1"7/8 12h UNF	S13038	29,89

## Tapón macho JIC 37°

37° JIC Male plug

Bouchon mâle JIC 37°

Tappo maschio JIC 37°

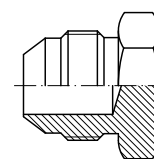

PIPE TUBO		THREAD ROSCA	Part n° Referencia	€
6		7/16" 20h UNF	S14006	1,27
8		1/2" 20h UNF	S14008	1,48
10		9/16" 18h UNF	S14010	1,48
12		3/4" 16h UNF	S14012	1,69
14-15-16		7/8" 14h UNF	S14016	1,90
18-20		1"1/16 12h UNF	S14020	3,27
25		1"5/16 12h UNF	S14025	4,44
30-32		1"5/8 12h UNF	S14032	7,92
38		1"7/8 12h UNF	S14038	24,70

# Racores JIC 37°

JIC 37° fittings

Raccords JIC 37°

Raccordi JIC 37°

## Racor macho-macho JIC 37°

Straight union JIC 37°

Adapteur droit mâle JIC x mâle JIC

Niples di giunzione maschio-maschio JIC 37°

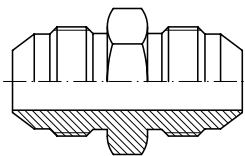

PIPE TUBO		THREAD ROSCA	Part n° Referencia	€
6	1/4	7/16" 20h UNF	S26006	1,28
8	5/16	1/2" 20h UNF	S26008	1,37
10	3/8	9/16" 18h UNF	S26010	1,46
12	1/2	3/4" 16h UNF	S26012	1,74
14-15-16	5/8	7/8" 14h UNF	S26016	2,56
18-20	3/4	1" 1/16 12h UNF	S26020	3,38
25	1	1" 5/16 12h UNF	S26025	5,94
30-32	1 1/4	1" 5/8 12h UNF	S26032	9,59
38	1 1/2	1" 7/8 12h UNF	S26038	16,54

## Racor hembra giratoria-hembra giratoria JIC 37°

Straight fitting with crimped nut JIC 37°

Adapteur femelle tournante JIC x femelle tournante JIC 37°

Niples femmina-femmina girevole JIC 37°

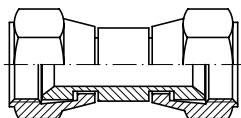

PIPE TUBO		THREAD ROSCA	Part n° Referencia	€
6	1/4	7/16" 20h UNF	S73006	4,11
8	5/16	1/2" 20h UNF	S73008	6,40
10	3/8	9/16" 18h UNF	S73010	5,30
12	1/2	3/4" 16h UNF	S73012	9,59
14-15-16	5/8	7/8" 14h UNF	S73016	10,32
18-20	3/4	1" 1/16 12h UNF	S73020	10,87
25	1	1" 5/16 12h UNF	S73025	17,63

## Racor macho JIC 37° - macho NPT

Straight adaptor male JIC-male NPT

Adapteur mâle JIC x mâle NPT

Niples di giunzione JIC 37°-NPT

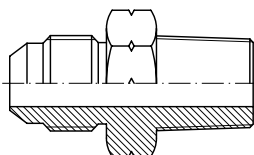

PIPE TUBO		THREAD ROSCA		Part n° Referencia	€
6	1/4	1/8" NPT	7/16" 20h UNF	S2000610	1,33
6	1/4	1/4" NPT	7/16" 20h UNF	S2000613	1,33
8	5/16	1/8" NPT	1/2" 20h UNF	S2000810	2,14
8	5/16	1/4" NPT	1/2" 20h UNF	S2000813	1,62
10	3/8	1/4" NPT	9/16" 18h UNF	S2001013	1,71
10	3/8	3/8" NPT	9/16" 18h UNF	S2001017	1,81
10	3/8	1/2" NPT	9/16" 18h UNF	S2001021	2,65
12	1/2	3/8" NPT	3/4" 16h UNF	S2001217	2,67
12	1/2	1/2" NPT	3/4" 16h UNF	S2001221	2,67
12	1/2	3/4" NPT	3/4" 16h UNF	S2001226	3,51
14-15-16	5/8	1/2" NPT	7/8" 14h UNF	S2001621	3,56
14-15-16	5/8	3/4" NPT	7/8" 14h UNF	S2001626	4,57
18-20	3/4	1/2" NPT	1" 1/16 12h UNF	S2002021	3,97
18-20	3/4	3/4" NPT	1" 1/16 12h UNF	S2002026	4,89
18-20	3/4	1" NPT	1" 1/16 12h UNF	S2002033	6,85
25	1	3/4" NPT	1" 5/16 12h UNF	S2002526	6,85
25	1	1" NPT	1" 5/16 12h UNF	S2002533	7,14
32	1 1/4	1" NPT	1" 5/8 12h UNF	S2003233	20,35
32	1 1/4	1" 1/4 NPT	1" 5/8 12h UNF	S2003242	15,23
38	1 1/2	1" 1/4 NPT	1" 7/8 12h UNF	S2003842	30,09
38	1 1/2	1" 1/2 NPT	1" 7/8 12h UNF	S2003848	25,14

## Racor macho JIC 37° - macho BSP

Straight adaptor male JIC-male BSP

Adapteur mâle JIC x mâle gaz cyl équipé

Niples di giunzione JIC 37°-BSP

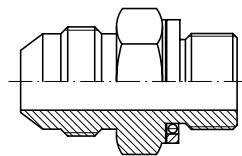

PIPE TUBO		THREAD ROSCA		Part n° Referencia	€
6	1/4	7/16" 20h UNF	1/8" BSP	S2300610	1,19
6	1/4	7/16" 20h UNF	1/4" BSP	S2300613	1,47
6	1/4	7/16" 20h UNF	3/8" BSP	S2300617	1,87
8	5/16	1/2" 20h UNF	1/4" BSP	S2300813	1,83
8	5/16	1/2" 20h UNF	3/8" BSP	S2300817	2,01
10	3/8	9/16" 18h UNF	1/4" BSP	S2301013	1,47
10	3/8	9/16" 18h UNF	3/8" BSP	S2301017	1,83
10	3/8	9/16" 18h UNF	1/2" BSP	S2301021	3,20
12	1/2	3/4" 16h UNF	1/4" BSP	S2301213	1,46
12	1/2	3/4" 16h UNF	3/8" BSP	S2301217	1,80
12	1/2	3/4" 16h UNF	1/2" BSP	S2301221	2,56
12	1/2	3/4" 16h UNF	3/4" BSP	S2301226	3,29
14-15-16	5/8	7/8" 14h UNF	3/8" BSP	S2301617	1,92
14-15-16	5/8	7/8" 14h UNF	1/2" BSP	S2301621	2,56
14-15-16	5/8	7/8" 14h UNF	3/4" BSP	S2301626	4,84
18-20	3/4	1" 1/16 12h UNF	1/2" BSP	S2302021	3,75
18-20	3/4	1" 1/16 12h UNF	3/4" BSP	S2302026	5,48
18-20	3/4	1" 1/16 12h UNF	1" BSP	S2302033	7,58
25	1	1" 5/16 12h UNF	3/4" BSP	S2302526	5,94
25	1	1" 5/16 12h UNF	1" BSP	S2302533	6,94
25	1	1" 5/16 12h UNF	1" 1/4 BSP	S2302542	10,69
30-32	1 1/4	1" 5/8 12h UNF	1" 1/4 BSP	S2303242	11,42
38	1 1/2	1" 7/8 12h UNF	1" 1/4 BSP	S2303842	12,70
38	1 1/2	1" 7/8 12h UNF	1" 1/2 BSP	S2303848	24,30

## Racor macho JIC 37° - macho BSPT

Straight adaptor male JIC-male BSPT

Adapteur mâle JIC x mâle gaz conique

Niples di giunzione JIC 37°-BSPT

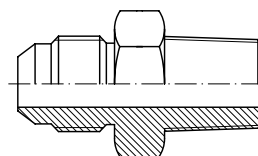

PIPE TUBO		THREAD ROSCA		Part n° Referencia	€
6	1/4	1/8" BSPT	7/16" 20h UNF	S2100610	0,82
6	1/4	1/4" BSPT	7/16" 20h UNF	S2100613	1,28
8	5/16	1/8" BSPT	1/2" 20h UNF	S2100810	1,01
8	5/16	1/4" BSPT	1/2" 20h UNF	S2100813	1,10
10	3/8	1/4" BSPT	9/16" 18h UNF	S2101013	1,37
10	3/8	3/8" BSPT	9/16" 18h UNF	S2101017	1,46
10	3/8	1/2" BSPT	9/16" 18h UNF	S2101021	1,83
12	1/2	1/4" BSPT	3/4" 16h UNF	S2101213	1,74
12	1/2	3/8" BSPT	3/4" 16h UNF	S2101217	2,19
12	1/2	1/2" BSPT	3/4" 16h UNF	S2101221	2,19
14-15-16	5/8	3/8" BSPT	7/8" 14h UNF	S2101617	2,92
14-15-16	5/8	1/2" BSPT	7/8" 14h UNF	S2101621	2,92
14-15-16	5/8	3/4" BSPT	7/8" 14h UNF	S2101626	2,56
18-20	3/4	1/2" BSPT	1" 1/16 12h UNF	S2102021	3,20
18-20	3/4	3/4" BSPT	1" 1/16 12h UNF	S2102026	3,42
25	1	3/4" BSPT	1" 5/16 12h UNF	S2102526	5,94
25	1	1" BSPT	1" 5/16 12h UNF	S2102533	5,64
30-32	1 1/4	1" BSPT	1" 5/8 12h UNF	S2103233	19,57
30-32	1 1/4	1" 1/4 BSPT	1" 5/8 12h UNF	S2103242	18,91
38	1 1/2	1" 1/2 BSPT	1" 7/8 12h UNF	S2103848	26,17

# Racores JIC 37°

JIC 37° fittings

Raccords JIC 37°

Raccordi JIC 37°

## Racor macho JIC 37° - macho UNF

Straight adaptor male JIC-male UNF

Adapteur mâle JIC x mâle UNF équipé

Niples di giunzione JIC 37°-UNF

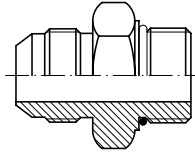

PIPE TUBO		THREAD ROSCA		Part n° Referencia	€
6	1/4	7/16" 20h JIC	7/16" 20h UNF	S2200611	1,10
6	1/4	7/16" 20h JIC	1/2" 20h UNF	S2200612	1,37
6	1/4	7/16" 20h JIC	9/16" 18h UNF	S2200614	1,28
8	5/16	1/2" 20h JIC	1/2" 20h UNF	S2200812	1,28
10	3/8	9/16" 18h JIC	9/16" 18h UNF	S2201014	1,55
10	3/8	9/16" 18h JIC	3/4" 16h UNF	S2201019	1,83
12	1/2	3/4" 16h JIC	3/4" 16h UNF	S2201219	2,56
12	1/2	3/4" 16h JIC	7/8" 14h UNF	S2201222	3,29
14-15-16	5/8	7/8" 14h JIC	7/8" 14h UNF	S2201622	3,29
14-15-16	5/8	7/8" 14h JIC	1"1/16 12h UNF	S2201627	5,03
14-15-16	5/8	7/8" 14h JIC	3/4" 16h UNF	S2201619	3,02
18-20	3/4	1"1/16 12h JIC	3/4" 16h UNF	S2202019	4,20
18-20	3/4	1"1/16 12h JIC	7/8" 14h UNF	S2202022	4,39
18-20	3/4	1"1/16 12h JIC	1"1/16 12h UNF	S2202027	5,30
18-20	3/4	1"1/16 12h JIC	1"5/16 12h UNF	S2202033	6,12
25	1	1"5/16 12h JIC	1"1/16 12h UNF	S2202527	8,72
25	1	1"5/16 12h JIC	1"5/16 12h UNF	S2202533	5,67
25	1	1"5/16 12h JIC	1"5/8 12h UNF	S2202541	23,97
30-32	1 1/4	1"5/8 12h JIC	1"5/8 12h UNF	S2203241	11,70
38	1 1/2	1"7/8 12h JIC	1"7/8 12h UNF	S2203848	29,37

## Adaptador Macho JIC - hembra giratoria JIC 37°

Adaptor male JIC - swivel female JIC

Adapteur mâle JIC x femelle tournante JIC

Niples maschio JIC - femmina girevole JIC 37°



PIPE TUBO	THREAD ROSCA	Part n° Referencia	€
6	7/16" 20h UNF	S7400606	2,82
8	1/2" 20h UNF	S7400808	3,40
10	9/16" 18h UNF	S7401010	3,47
12	3/4" 16h UNF	S7401212	4,48
14-15-16	7/8" 14h UNF	S7401616	5,71
18-20	1" 1/16 12 h UNF	S7402020	7,01
25	1" 5/16 12 h UNF	S7402525	10,47

## Racor pasatabiques JIC 37°

Straight bulkhead fitting JIC 37°

Union passe cloison droite mâle JIC x mâle JIC équipé

Niples passaparete JIC 37°

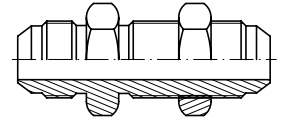

PIPE TUBO		THREAD ROSCA		Part n° Referencia	€
6	1/4	7/16" 20h UNF		S25006	2,28
8	5/16	1/2" 20h UNF		S25008	3,02
10	3/8	9/16" 18h UNF		S25010	3,38
12	1/2	3/4" 16h UNF		S25012	4,20
14-15-16	5/8	7/8" 14h UNF		S25016	5,30
18-20	3/4	1"1/16 12h UNF		S25020	7,95
25	1	1"5/16 12h UNF		S25025	9,05
30-32	1 1/4	1"5/8 12h UNF		S25032	19,28
38	1 1/2	1"7/8 12h UNF		S25038	45,06

## Racor macho JIC 37° - macho Métrico

Metric adaptor male-male JIC 37°

Adapteur mâle JIC x mâle Métrique équipé

Niples di giunzione JIC 37°-Metrico

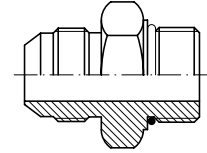

PIPE TUBO		THREAD ROSCA		Part n° Referencia	€
6	1/4	7/16" 20h UNF	M10X1	S2400610	2,74
8	5/16	1/2" 20h UNF	M12X1.5	S2400812	2,92
10	3/8	9/16" 18h UNF	M14X1.5	S2401014	3,00
12	1/2	3/4" 16h UNF	M16X1.5	S2401216	3,11
12	1/2	3/4" 16h UNF	M18X1.5	S2401218	3,66
14-15-16	5/8	7/8" 14h UNF	M18X1.5	S2401418	4,20
14-15-16	5/8	7/8" 14h UNF	M22X1.5	S2401622	4,57
20	3/4	1"1/16 12h UNF	M18X1.5	S2402018	7,13
18-20	3/4	1"1/16 12h UNF	M22X1.5	S2402022	7,13
18-20	3/4	1"1/16 12h UNF	M27X2	S2402027	9,32
25	1	1"5/16 12h UNF	M33X2	S2402533	14,81
30-32	1 1/4	1"5/8 12h UNF	M42X2	S2403242	29,00

# Racores JIC 37°

JIC 37° fittings

Raccords JIC 37°

Raccordi JIC 37°

Pipe

DIN 2353 Pipe Fittings

Gas tube fittings

JIC 37° fittings

SAE Flanges

Clamps

Machines for processing rigid pipes

## Adaptador hembra giratoria JIC - Macho NPT (60°)

Adaptor swivel female JIC 37° - NPT male 60°

Adapteur femelle tournante JIC x mâle NPT 60°

Nipples femmina girevole JIC 37° - maschio NPT 60°



THREAD ROSCA		Part n° Referencia	€
F 7/16" 20h UNF	M 1/4" NPT	S1600604	2,96
F 1/2" 20h UNF	M 1/4" NPT	S1600804	3,54
F 9/16" 18h UNF	M 1/4" NPT	S1601004	3,54
F 9/16" 18h UNF	M 3/8" NPT	S1601006	3,83
3/4" 16h UNF	M 3/8" NPT	S1601206	4,84
3/4" 16h UNF	M 1/2" NPT	S1601208	4,70
7/8" 14h UNF	M 1/2" NPT	S1601608	6,00
1" 1/16 12 h UNF	M 3/4" NPT	S1602012	7,44
1" 5/16 12 h UNF	M 1" NPT	S1602516	11,99

## Racor macho BSP - hembra giratoria JIC 37°

Adaptor swivel nut JIC-male BSP

Adapteur femelle tournante JIC x mâle gaz cyl équipé

Nipples maschio-femmina BSP-JIC 37°

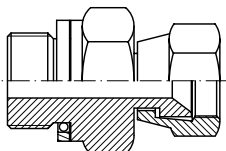

PIPE TUBO	THREAD ROSCA	Part n° Referencia	€
6 1/4	M 1/8" BSP F 7/16" 20F UNF	S1800610	3,59
8 5/16	M 1/4" BSP F 1/2" 20F UNF	S1800813	4,54
8 5/16	M 3/8" BSP F 1/2" 20F UNF	S1800817	4,51
10 3/8	M 1/4" BSP F 9/16" 18F UNF	S1801013	5,39
10 3/8	M 3/8" BSP F 9/16" 18F UNF	S1801017	6,65
12 1/2	M 3/8" BSP F 3/4" 16F UNF	S1801217	7,08
14-15-16 5/8	M 1/2" BSP F 7/8" 14F UNF	S1801621	9,61
18-20 3/4	M 3/4" BSP F 1" 1/16 12F UNF	S1802026	11,09
25 1	M 1" BSP F 1" 5/8 12F UNF	S1802533	16,05
30-32 1 1/4	M 1" 1/4 BSP F 1" 5/8 12F UNF	S1803242	25,14
38 1 1/2	M 1" 1/2 BSP F 1" 7/8 12F UNF	S1803848	64,87

## Racor unión macho-hembra JIC 37°

Reducer adaptor JIC-JIC

Reducteur mâle JIC x femelle JIC

Riduzione maschio-femmina JIC 37°

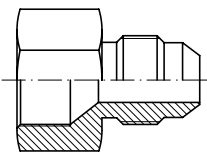

PIPE TUBO	THREAD ROSCA	Part n° Referencia	€
10 6	F 9/16" 18F UNF M 7/16" 20h UNF	S2901006	4,51
12 6	F 3/4" 16F UNF M 7/16" 20h UNF	S2901206	4,71
8 12	F 3/4" 16F UNF M 1/2" 20h UNF	S2901208	6,35
12 10	F 3/4" 16F UNF M 9/16" 18h UNF	S2901210	5,14
14-15-16 6	F 7/8" 14F UNF M 7/16" 20h UNF	S2901606	7,08
14-15-16 10	F 7/8" 14F UNF M 9/16" 18h UNF	S2901610	7,75
14-15-16 12	F 7/8" 14F UNF M 3/4" 16h UNF	S2901612	6,34
18-20 6	F 1" 1/16 12F UN M 7/16" 20h UNF	S2902006	8,23
18-20 12	F 1" 1/16 12F UN M 3/4" 16h UNF	S2902012	7,75
25 18-20	F 1" 5/8 12F UN M 1" 1/16 12h UN	S2902520	9,83
30-32 25	F 1" 5/8 12F UN M 1" 5/8 12h UN	S2903225	19,07
38 30-32	F 1" 7/8 12F UN M 1" 5/8 12h UN	S2903832	25,44

## Racor macho JIC 37° - hembra fija BSP

Adaptor male JIC 37°-fixed female BSP

Adapteur mâle JIC x femelle gaz cyl

Nipples maschio-femmina JIC 37°-BSP

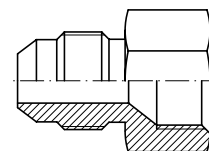

PIPE TUBO	THREAD ROSCA	Part n° Referencia	€
6 1/4	M 7/16" 20h UNF F 1/8" BSP	S2800610	4,42
6 1/4	M 7/16" 20h UNF F 1/4" BSP	S2800613	4,65
8 5/16	M 1/2" 20h UNF F 1/8" BSP	S2800810	5,31
8 5/16	M 1/2" 20h UNF F 1/4" BSP	S2800813	5,31
10 3/8	M 9/16" 18h UNF F 1/4" BSP	S2801013	5,17
10 3/8	M 9/16" 18h UNF F 3/8" BSP	S2801017	5,31
12 1/2	M 3/4" 16h UNF F 3/8" BSP	S2801217	5,17
12 1/2	M 3/4" 16h UNF F 1/2" BSP	S2801221	6,57
14-15-16 5/8	M 7/8" 14h UNF F 1/2" BSP	S2801621	6,25
18-20 3/4	M 1" 1/16 12h UNF F 1/2" BSP	S2802021	8,72
18-20 3/4	M 1" 1/16 12h UNF F 3/4" BSP	S2802026	8,21
25 1	M 1" 5/8 12h UNF F 1" BSP	S2802533	16,99
30-32 1 1/4	M 1" 5/8 12h UN F 1" 1/4 BSP	S2803242	27,76
38 1 1/2	M 1" 7/8 12h UNF F 1" 1/2 BSP	S2803848	42,33

## Racor macho BSPT - hembra giratoria JIC 37°

Adaptor male BSPT-swivel female JIC 37°

Adapteur femelle tournante JIC x mâle gaz conique

Nipples maschio-femmina BSPT-JIC 37°

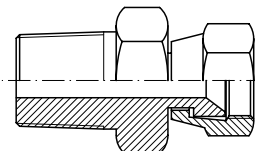

PIPE TUBO	THREAD ROSCA	Part n° Referencia	€
6 1/4	M 1/4" BSPT F 7/16" 20h UNF	S1500613	6,51
8 5/16	M 1/4" BSPT F 1/2" 20h UNF	S1500813	6,69
10 3/8	M 1/4" BSPT F 9/16" 18h UNF	S1501013	6,51
12 1/2	M 1/4" BSPT F 3/4" 16h UNF	S1501213	8,02
12 1/2	M 3/8" BSPT F 3/4" 16h UNF	S1501217	7,59
16 5/8	M 1/2" BSPT F 7/8" 14h UNF	S1501621	10,89
20 3/4	M 1/2" BSPT F 1" 1/16 12h UNF	S1502021	12,31
20 3/4	M 3/4" BSPT F 1" 1/16 12h UNF	S1502026	12,58
25 1	M 3/4" BSPT F 1" 5/8 12h UNF	S1502526	26,15
25 1	M 1" BSPT F 1" 5/8 12h UNF	S1502533	24,20
32 1 1/4	M 1" 1/4 BSPT F 1" 5/8 12h UNF	S1503242	36,76

# Racores JIC 37°

JIC 37° fittings

Raccords JIC 37°

Raccordi JIC 37°

## Adaptador hembra giratoria JIC - Macho BSP (60°)

Adaptor swivel female JIC 37° - BSP male 60°

Adapteur femelle tournante JIC x mâle BSP 60°

Nipples femmina girevole JIC 37° - maschio BSP 60°

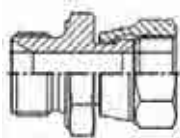

THREAD ROSCA		Part n° Referencia	€
M 1/4" BSP	F 7/16" UNF	S2150604	3,25
M 1/4" BSP	F 1/2" UNF	S2150804	3,32
M 1/4" BSP	F 9/16" UNF	S2151004	3,47
M 3/8" BSP	F 9/16" UNF	S2151006	3,97
M 1/2" BSP	F 9/16" UNF	S2151008	4,91
M 3/8" BSP	F 3/4" UNF	S2151206	4,19
M 1/2" BSP	F 3/4" UNF	S2151208	5,42
M 1/2" BSP	F 7/8" UNF	S2151608	5,71
M 3/4" BSP	F 1" 1/16 UNF	S2152012	6,93
M 1" BSP	F 1"5/16 UNF	S2152516	12,93

## Codo 90° macho - macho JIC 37°

90° Male elbow male JIC 37°-male JIC 37°

Adapteur coude 90° mâle JIC 37° x mâle JIC 37°

Adattatore a 90° maschio-maschio JIC 37°

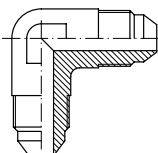

PIPE TUBO		THREAD ROSCA	Part n° Referencia	€
6	1/4	7/16" 20h UNF	S50006	2,74
8	5/16	1/2" 20h UNF	S50008	3,75
10	3/8	9/16" 18h UNF	S50010	3,20
12	1/2	3/4" 16h UNF	S50012	4,30
14-15-16	5/8	7/8" 14h UNF	S50016	5,76
18-20	3/4	1" 1/16 12h UNF	S50020	9,05
25	1	1"5/16 12h UNF	S50025	12,24
30-32	1 1/4	1"5/8 12h UNF	S50032	30,64
38	1 1/2	1"7/8 12h UNF	S50038	44,37

## Codo 90° pasatabiques JIC 37°

90° Bulkhead coupling male JIC 37°-male JIC 37°

Adapteur coude 90° passe cloison mâle JIC 37° x mâle JIC 37° équipé

Adattatore a 90° passaparete maschio-maschio JIC 37°

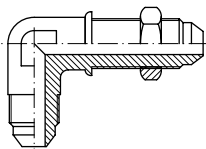

PIPE TUBO		THREAD ROSCA	Part n° Referencia	€
6	6	7/16" 20h UNF	S65006	4,20
8	8	1/2" 20h UNF	S65008	3,93
10	10	9/16" 18h UNF	S65010	4,11
12	12	3/4" 16h UNF	S65012	5,57
14-15-16	14-15-16	7/8" 14h UNF	S65016	8,04
18-20	18-20	1" 1/16 12h UNF	S65020	13,98
25	25	1"5/16 12h UNF	S65025	26,32

## Codo 90° macho JIC 37° - macho BSPT

90° male elbow male JIC 37° - male BSPT

Adapteur coude 90° mâle JIC 37° x mâle gaz conique

Adattatore a 90° maschio-maschio JIC 37°-BSPT

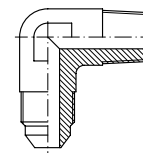

PIPE TUBO		THREAD ROSCA		Part n° Referencia	€
6	1/4	7/16" 20h UNF	1/8" BSPT	S5500610	6,51
6	1/4	7/16" 20h UNF	1/4" BSPT	S5500613	6,58
8	5/16	1/2" 20h UNF	1/8" BSPT	S5500810	8,88
8	5/16	1/2" 20h UNF	1/4" BSPT	S5500813	6,44
10	3/8	9/16" 18h UNF	1/4" BSPT	S5501013	4,90
10	3/8	9/16" 18h UNF	3/8" BSPT	S5501017	6,78
10	3/8	9/16" 18h UNF	1/2" BSPT	S5501021	12,45
12	1/2	3/4" 16h UNF	1/4" BSPT	S5501213	10,52
12	1/2	3/4" 16h UNF	3/8" BSPT	S5501217	6,90
12	1/2	3/4" 16h UNF	1/2" BSPT	S5501221	9,08
14-15-16	5/8	7/8" 14h UNF	3/8" BSPT	S5501617	10,59
14-15-16	5/8	7/8" 14h UNF	1/2" BSPT	S5501621	8,34
14-15-16	5/8	7/8" 14h UNF	3/4" BSPT	S5501626	15,98
18-20	3/4	1" 1/16 12h UNF	1/2" BSPT	S5502021	17,88
18-20	3/4	1" 1/16 12h UNF	3/4" BSPT	S5502026	14,33
25	1	1"5/16 12h UNF	3/4" BSPT	S5502526	25,81
25	1	1"5/16 12h UNF	1" BSPT	S5502533	21,41
30-32	1 1/4	1"5/8 12h UNF	1" BSPT	S5503233	30,19
30-32	1 1/4	1"5/8 12h UNF	1" 1/4 BSPT	S5503242	31,10
38	1 1/2	1"7/8 12h UNF	1" 1/2 BSPT	S5503848	72,63

# Racores JIC 37°

JIC 37° fittings  
Raccords JIC 37°  
Raccordi JIC 37°

## Codo 90° macho - hembra giratoria JIC 37°

90° Elbow swivel nut JIC 37°-male JIC 37°

Adapteur coude 90° mâle JIC 37° x femelle tournante JIC 37°

Adattatore a 90° maschio-femmina girevole JIC 37°

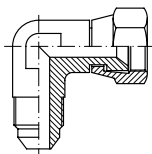

PIPE TUBO		THREAD ROSCA	Part n° Referencia	€
6	1/4	7/16" 20h UNF	S67506	3,75
8	5/16	1/2" 20h UNF	S67508	4,84
10	3/8	9/16" 18h UNF	S67510	5,12
12	1/2	3/4" 16h UNF	S67512	7,22
14-15-16	5/8	7/8" 14h UNF	S67516	7,49
18-20	3/4	1"1/16 12h UNF	S67520	8,86
25	1	1"5/16 12h UNF	S67525	20,19
30-32	1 1/4	1"5/8 12h UNF	S67532	49,66
38	1 1/2	1"7/8 12h UNF	S67538	48,70

## Codo 90° macho JIC 37° - macho NPT

90° Male elbow male JIC 37°-male NPT

Adapteur coude 90° mâle JIC 37° x mâle NPT

Adattatore a 90° maschio-maschio JIC 37°-NPT

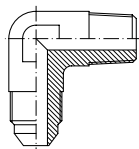

PIPE TUBO		THREAD ROSCA		Part n° Referencia	€
6	1/4	7/16" 20h UNF	1/8" NPT	S5250610	3,97
6	1/4	7/16" 20h UNF	1/4" NPT	S5250613	4,68
8	5/16	1/2" 20h UNF	1/8" NPT	S5250810	5,13
8	5/16	1/2" 20h UNF	1/4" NPT	S5250813	5,68
10	3/8	9/16" 18h UNF	1/4" NPT	S5251013	3,58
10	3/8	9/16" 18h UNF	3/8" NPT	S5251017	4,41
10	3/8	9/16" 18h UNF	1/2" NPT	S5251021	9,24
12	1/2	3/4" 16h UNF	1/4" NPT	S5251213	5,78
12	1/2	3/4" 16h UNF	3/8" NPT	S5251217	5,76
12	1/2	3/4" 16h UNF	1/2" NPT	S5251221	6,90
14-15-16	5/8	7/8" 14h UNF	3/8" NPT	S5251617	9,65
14-15-16	5/8	7/8" 14h UNF	1/2" NPT	S5251621	9,60
14-15-16	5/8	7/8" 14h UNF	3/4" NPT	S5251626	17,72
18-20	3/4	1"1/16 12h UNF	1/2" NPT	S5252021	12,40
18-20	3/4	1"1/16 12h UNF	3/4" NPT	S5252026	10,80
25	1	1"5/16 12h UNF	3/4" NPT	S5252526	19,96
25	1	1"5/16 12h UNF	1" NPT	S5252533	20,01
30-32	1 1/4	1"5/8 12h UNF	1" NPT	S5253233	32,27
30-32	1 1/4	1"5/8 12h UNF	1 1/4" NPT	S5253242	32,27
38	1 1/2	1"7/8 12h UNF	1"1/2 NPT	S5253848	53,77

## Codo 45° macho - hembra giratoria JIC 37°

45° Elbow male-swivel nut JIC 37°

Adapteur coude 45° mâle JIC 37° x femelle tournante JIC 37°

Adattatore a 45° maschio-femmina girevole JIC 37°

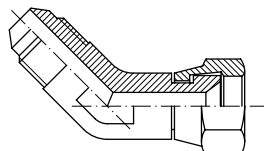

PIPE TUBO		THREAD ROSCA	Part n° Referencia	€
6	1/4	7/16" 20h UNF	S69006	4,11
8	5/16	1/2" 20h UNF	S69008	5,21
10	3/8	9/16" 18h UNF	S69010	5,67
12	1/2	3/4" 16h UNF	S69012	6,94
14-15-16	5/8	7/8" 14h UNF	S69016	9,32
18-20	3/4	1"1/16 12h UNF	S69020	11,97
25	1	1"5/16 12h UNF	S69025	20,10

## Codo 90° macho JIC 37° - macho BSP orientable

90° Banjo elbow male JIC 37°-BSP Banjo male

Adapteur orientable coude 90° mâle JIC 37° x mâle gaz cyl + o'ring équipé

Adattatore a 90° maschio-maschio orientabile JIC 37°-BSP

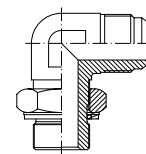

PIPE TUBO		THREAD ROSCA		Part n° Referencia	€
6	1/4	7/16" 20h UNF	1/8" BSP	S6000610	3,47
6	1/4	7/16" 20h UNF	1/4" BSP	S6000613	4,30
8	5/16	1/2" 20h UNF	1/8" BSP	S6000810	4,11
8	5/16	1/2" 20h UNF	1/4" BSP	S6000813	5,03
10	3/8	9/16" 18h UNF	1/4" BSP	S6001013	5,03
10	3/8	9/16" 18h UNF	3/8" BSP	S6001017	5,30
10	3/8	9/16" 18h UNF	1/2" BSP	S6001021	10,82
12	1/2	3/4" 16h UNF	1/4" BSP	S6001213	5,76
12	1/2	3/4" 16h UNF	3/8" BSP	S6001217	6,12
12	1/2	3/4" 16h UNF	1/2" BSP	S6001221	7,22
16	5/8	7/8" 14h UNF	3/8" BSP	S6001617	7,77
14-15-16	5/8	7/8" 14h UNF	1/2" BSP	S6001621	7,86
18-20	3/4	1"1/16 12h UNF	1/2" BSP	S6002021	10,87
18-20	3/4	1"1/16 12h UNF	3/4" BSP	S6002026	10,60
18-20	3/4	1"1/16 12h UNF	1" BSP	S6002033	17,54
25	1	1"5/16 12h UNF	3/4" BSP	S6002526	16,90
25	1	1"5/16 12h UNF	1" BSP	S6002533	18,92
30-32	1 1/4	1"5/8 12h UNF	1" BSP	S6003233	25,68
30-32	1 1/4	1"5/8 12h UNF	1"1/4 BSP	S6003242	32,02
38	1 1/2	1"7/8 12h UNF	1"1/4 BSP	S6003842	60,53
38	1 1/2	1"7/8 12h UNF	1"1/2 BSP	S6003848	71,61

## Codo 45° macho JIC 37° - macho BSP orientable

45° Elbow male JIC 37°-BSP Banjo male

Adapteur coude 45° mâle JIC 37° x mâle gaz cyl + o'ring équipé

Adattatore a 45° maschio JIC 37°-maschio BSP orientabile

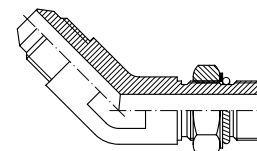

PIPE TUBO		THREAD ROSCA		Part n° Referencia	€
8	5/16	1/2" 20h UNF	1/4" BSP	S6150813	4,39
10	3/8	9/16" 18h UNF	1/4" BSP	S6151013	5,30
12	1/2	3/4" 16h UNF	3/8" BSP	S6151217	6,67
12	1/2	3/4" 16h UNF	1/2" BSP	S6151221	7,40
14-15-16	5/8	7/8" 14h UNF	1/2" BSP	S6151621	7,13
18-20	3/4	1"1/16 12h UNF	1/2" BSP	S6152021	10,97
18-20	3/4	1"1/16 12h UNF	3/4" BSP	S6152026	10,97
25	1	1"5/16 12h UNF	1" BSP	S6152533	17,56

# Racores JIC 37°

JIC 37° fittings

Raccords JIC 37°

Raccordi JIC 37°

## Codo 90° macho JIC 37° - macho UNF orientable

90° Banjo elbow male JIC 37°-unf Banjo male

Adapteur orientable coude 90° mâle JIC 37° x mâle UNF + o'ring équipé

Adattatore a 90° maschio-maschio orientabile JIC 37°-UNF

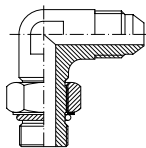

PIPE TUBO		THREAD ROSCA		Part n° Referencia	€
6	1/4	7/16" 20h JIC	7/16" 20h UNF	S5750611	3,75
6	1/4	7/16" 20h JIC	1/2" 20h UNF	S5750612	7,27
8	5/16	1/2" 20h JIC	1/2" 20h UNF	S5750812	4,20
10	3/8	9/16" 18h JIC	9/16" 18h UNF	S5751014	5,39
10	3/8	9/16" 18h JIC	3/4" 16h UNF	S5751019	5,94
12	1/2	3/4" 16h JIC	7/8" 14h UNF	S5751222	11,64
14-15-16	5/8	7/8" 14h JIC	3/4" 16h UNF	S5751619	12,42
14-15-16	5/8	7/8" 14h JIC	7/8" 14h UNF	S5751622	10,05
18-20	3/4	1"1/16 12h JIC	7/8" 14h UNF	S5752022	14,76
18-20	3/4	1"1/16 12h JIC	1"1/16 12h UNF	S5752027	11,70
25	1	1"5/16 12h JIC	1"1/16 12h UNF	S5752527	25,35
25	1	1"5/16 12h JIC	1"5/16 12h UNF	S5752533	20,83
30-32	1 1/4	1"5/8 12h JIC	1"5/8 12h UNF	S5753241	41,30
38	1 1/2	1"7/8 12h JIC	1"7/8 12h UNF	S5753848	63,17

## Codo 90° macho JIC 37° - macho métrico orientable

90° Elbow male JIC 37°-Metric Banjo male

Adapteur orientable coude 90° mâle JIC 37° x mâle Métrique + o'ring équipé

Adattatore a 90° maschio-maschio orientabile JIC 37° Metrico

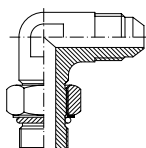

PIPE TUBO		THREAD ROSCA		Part n° Referencia	€
6	1/4	7/16" 20h UNF	M10x1	S6250610	3,66
8	5/16	1/2" 20h UNF	M12x1,5	S6250812	9,01
10	3/8	9/16" 18h UNF	M14x1,5	S6251014	4,93
12	1/2	3/4" 16h UNF	M16x1,5	S6251216	10,15
12	1/2	3/4" 16h UNF	M18x1,5	S6251218	6,58
14-15-16	5/8	7/8" 14h UNF	M18x1,5	S6251618	11,62
14-15-16	5/8	7/8" 14h UNF	M22x1,5	S6251622	9,23
18-20	3/4	1"1/16 12h UNF	M22x1,5	S6252022	13,16
18-20	3/4	1"1/16 12h UNF	M27x2	S6252027	18,13
25	1	1"5/16 12h UNF	M33x2	S6252533	20,01

## Codo 90° hembra giratoria JIC 37°- hembra giratoria JIC 37°

90° Elbow swivel nut JIC 37°-swivel nut JIC 37°

Adapteur coude 90° femelle tournante JIC 37° x femelle tournante JIC 37°

Adattatore a 90° femmina girevole JIC 37°-femmina girevole JIC 37°

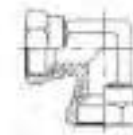

PIPE TUBO	THREAD ROSCA	Part n° Referencia	€
6	7/16" 20h UNF	S6650606	4,70
8	1/2" 20h UNF	S6650808	5,71
10	9/16" 18h UNF	S6651010	5,71
12	3/4" 16h UNF	S6651212	6,65
14-15-16	7/8" 14h UNF	S6651616	12,14
18-20	1" 1/16 12 h UNF	S6652020	20,66
25	1" 5/16 12 h UNF	S6652525	25,93

## Codo 90° hembra giratoria JIC 37°- Macho NPT (60°)

90° Elbow swivel nut JIC 37°-NPT male (60°)

Adapteur coude 90° femelle tournante JIC 37° x mâle NPT (60°)

Adattatore a 90° femmina girevole JIC 37°-maschio NPT (60°)



THREAD ROSCA	Part n° Referencia	€	
F 7/16" 20h UNF	M 1/4" NPT	S5950604	3,97
F 1/2" 20h UNF	M 1/4" NPT	S5950804	4,91
F 9/16" 18h UNF	M 1/4" NPT	S5951004	4,98
F 9/16" 18h UNF	M 3/8" NPT	S5951006	4,98
3/4" 16h UNF	M 3/8" NPT	S5951206	6,86
3/4" 16h UNF	M 1/2" NPT	S5951208	6,93
7/8" 14h UNF	M 1/2" NPT	S5951608	7,37
1" 1/16 12 h UNF	M 3/4" NPT	S5952012	10,04
1" 5/16 12 h UNF	M 1" NPT	S5952516	19,43



# Racores JIC 37°

JIC 37° fittings  
Raccords JIC 37°  
Raccordi JIC 37°

## Tes macho-macho-macho JIC 37°

Union Tee male JIC 37°

Tés égaux mâle JIC 37°

Adattatore a T maschio JIC 37°

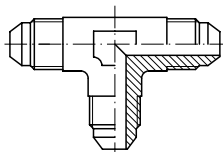

PIPE TUBO		THREAD ROSCA	Part n° Referencia	€
6	1/4	7/16" 20h UNF	S50506	4,20
8	5/16	1/2" 20h UNF	S50508	4,30
10	3/8	9/16" 18h UNF	S50510	5,12
12	1/2	3/4" 16h UNF	S50512	7,77
14-15-16	5/8	7/8" 14h UNF	S50516	8,96
18-20	3/4	1"1/16 12h UNF	S50520	11,51
25	1	1"5/16 12h UNF	S50525	17,27
30-32	1 1/4	1"5/8 12h UNF	S50532	45,20
38	1 1/2	1"7/8 12h UNF	S50538	94,45

## Tes macho-macho-hembra giratoria JIC 37°

Swivel run Tee male JIC 37°-swivel nut JIC 37°

Tés égaux tournantes JIC 37° au latéral

Adattatore a T maschio-maschio-femmina  
girevole JIC 37°

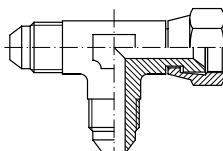

PIPE TUBO		THREAD ROSCA	Part n° Referencia	€
6	1/4	7/16" 20h UNF	S68006	5,76
8	5/16	1/2" 20h UNF	S68008	5,48
10	3/8	9/16" 18h UNF	S68010	5,48
12	1/2	3/4" 16h UNF	S68012	8,77
14-15-16	5/8	7/8" 14h UNF	S68016	10,87
18-20	3/4	1"1/16 12h UNF	S68020	13,61
25	1	1"5/16 12h UNF	S68025	25,11
30-32	1 1/4	1"5/8 12h UNF	S68032	62,62
38	1 1/2	1"7/8 12h UNF	S68038	93,51

## Tes macho-hembra giratoria-macho JIC 37°

Swivel brunch Tee male JIC 37°-swivel nut JIC  
37°-male JIC 37°

Tés égaux tournantes JIC 37° au centre

Adattatore a T maschio-femmina girevole-  
maschio JIC 37°

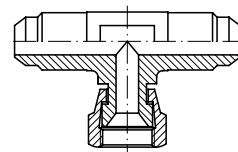

PIPE TUBO		THREAD ROSCA	Part n° Referencia	€
6	1/4	7/16" 20h UNF	S68506	5,76
8	5/16	1/2" 20h UNF	S68508	5,48
10	3/8	9/16" 18h UNF	S68510	5,48
12	1/2	3/4" 16h UNF	S68512	8,77
14-15-16	5/8	7/8" 14h UNF	S68516	10,87
18-20	3/4	1"1/16 12h UNF	S68520	13,61
25	1	1"5/16 12h UNF	S68525	37,31
30-32	1 1/4	1"5/8 12h UNF	S68532	61,40
38	1 1/2	1"7/8 12h UNF	S68538	91,84

Pipe

DIN 2353 Pipe Fittings

Gas tube fittings

JIC 37° fittings

SAE Flanges

Clamps

Machines for  
processing rigid pipes

# Racores JIC 37°

JIC 37° fittings

Raccords JIC 37°

Raccordi JIC 37°

## Te macho JIC37° - macho orientable BSP - macho JIC37°

Tee male JIC 37°-BSP central Banjo male-male JIC 37°

Té mâle JIC 37° - mâle orientable BSP - mâle JIC 37°

Raccordo a T JIC 37° orientabile centrale BSP (M-M orientabile-M)

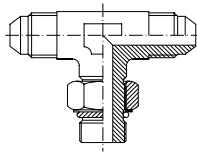

PIPE TUBO		THREAD ROSCA		Part n° Referencia	€
6	1/4	7/16" 20h UNF	1/4" BSP	S6100613	5,39
8	5/16	1/2" 20h UNF	1/4" BSP	S6100813	10,36
10	3/8	9/16" 18h UNF	1/4" BSP	S6101013	5,39
12	1/2	3/4" 16h UNF	3/8" BSP	S6101217	6,85
14-15-16	5/8	7/8" 14h UNF	1/2" BSP	S6101621	11,88
18-20	3/4	1"1/16 12h UNF	3/4" BSP	S6102026	25,26
25	1	1"5/16 12h UNF	1" BSP	S6102533	25,40
30-32	1 1/4	1"5/8 12h UNF	1"1/4 BSP	S6103242	64,68

## Te macho JIC 37° - macho orientable UNF-macho JIC37°

Tee male JIC 37°-central Banjo UNF-male JIC 37°

Té mâle JIC 37° - mâle orientable UNF - mâle JIC 37°

Raccordo a T JIC 37° orientabile centrale UNF (M-M orientabile-M)

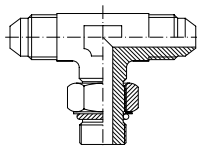

PIPE TUBO		THREAD ROSCA		Part n° Referencia	€
6	1/4	7/16" 20h UNF		S5850611	10,41
8	5/16	1/2" 20h UNF		S5850812	13,91
10	3/8	9/16" 18h UNF		S5851014	14,21
12	1/2	3/4" 16h UNF		S5851219	14,00
14-15-16	5/8	7/8" 14h UNF		S5851622	21,13
18-20	3/4	1"1/16 12h UNF		S5852027	27,89
25	1	1"5/16 12h UNF		S5852533	41,81

## Te macho JIC 37° - macho orientable métrico-macho JIC37°

Tee male JIC 37°-Metric central Banjo male-male JIC 37°

Té mâle JIC 37° - mâle orientable Métrique - mâle JIC 37°

Raccordo a T JIC 37° orientabile centrale Metrico (M-M orientabile-M)

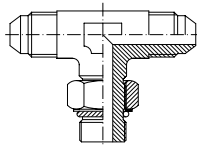

PIPE TUBO		THREAD ROSCA		Part n° Referencia	€
8	5/16	1/2" JIC	M12X1.5	S6350812	12,77
10	3/8	9/16" JIC	M14X1.5	S6351014	11,02
12	1/2	3/4" JIC	M18X1.5	S6351218	15,04
14-15-16	5/8	7/8" JIC	M18X1.5	S6351618	23,42
14-15-16	5/8	7/8" JIC	M22X1.5	S6351622	23,42
18-20	3/4	1"1/16 JIC	M27X2	S6352027	29,38
25	1	1"5/16 JIC	M33X2	S6352533	38,39

## Te macho JIC 37°- macho JIC37°- macho orientable BSP

Tee male JIC 37°-male JIC 37°-male BSP lateral Banjo

Té mâle JIC 37° - mâle JIC 37° - mâle orientable BSP

Raccordo a T JIC 37° orientabile laterale BSP (M-M-M orientabile)

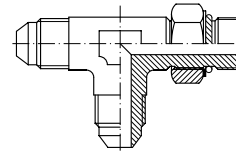

PIPE TUBO		THREAD ROSCA		Part n° Referencia	€
8	5/16	1/2" 20h UNF	1/4" BSP	S6050813	4,93
10	3/8	9/16" 18h UNF	1/4" BSP	S6051013	8,10
12	1/2	3/4" 16h UNF	3/8" BSP	S6051217	6,76
14-15-16	5/8	7/8" 14h UNF	1/2" BSP	S6051621	9,69
18-20	3/4	1"1/16 12h UNF	3/4" BSP	S6052026	19,92
25	1	1"5/16 12h UNF	1" BSP	S6052533	38,00
30-32	1 1/4	1"5/8 12h UNF	1"1/4 BSP	S6053242	57,21
38	1 1/2	1"7/8 12h UNF	1"1/2 BSP	S6053848	78,45

## Te macho JIC 37° - macho JIC37°- macho orientable UNF

Tee male JIC 37°-male JIC37°- lateral Banjo UNF

Té mâle JIC 37° - mâle JIC 37° - mâle orientable UNF

Raccordo a T JIC 37° orientabile laterale UNF (M-M-M orientabile)

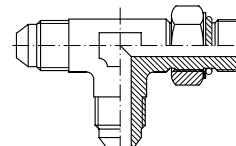

PIPE TUBO		THREAD ROSCA		Part n° Referencia	€
6	1/4	7/16" JIC	7/16" UNF	S5800611	16,46
8	5/16	1/2" JIC	1/2" UNF	S5800812	16,46
10	3/8	9/16" JIC	9/16" UNF	S5801014	10,06
16	5/8	7/8" JIC	7/8" UNF	S5801622	19,83
20	3/4	1"1/16 JIC	1"1/16 UNF	S5802027	30,64
25	1	1"5/16 JIC	1"5/16 UNF	S5802533	45,61

## Te macho JIC 37° - macho JIC37°- macho orientable métrico

Tee male JIC 37°-male JIC37°-male Metric lateral Banjo

Té mâle JIC 37° - mâle JIC - mâle orientable Métrique

Raccordo a T JIC 37° orientabile laterale Metrico (M-M-M orientabile)

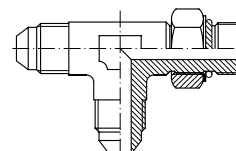

PIPE TUBO		THREAD ROSCA		Part n° Referencia	€
12	1/2	3/4" 16h UNF	M16x1,5	S6301216	14,35
14-15-16	5/8	7/8" 14h UNF	M22x1,5	S6301622	22,97
18-20	3/4	1"1/16 12h UNF	M27X1.5	S6302027	29,38
25	1	1"5/16 12h UNF	M33x2	S6302533	46,48

## Te H.G. JIC 37°- H.G. JIC 37° - H.G. JIC 37°

Tee female JIC 37° - female JIC 37° - female JIC 37°

Té femelle tournante JIC - femelle tournante JIC - femelle tournante JIC

Raccordo a T JIC 37° (F-F-F orientabile)

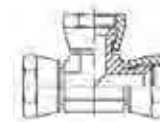

PIPE TUBO		THREAD ROSCA		Part n° Referencia	€
6		7/16" 20h UNF		S6700606	11,20
8		1/2" 20h UNF		S6700808	13,58
10		9/16" 18h UNF		S6701010	13,58
12		3/4" 16h UNF		S6701212	16,98
14-15-16		7/8" 14h UNF		S6701616	23,62
18-20		1" 1/16 12 h UNF		S6702020	29,69
25		1" 5/16 12 h UNF		S6702525	49,48

# Racores JIC 37°

JIC 37° fittings

Raccords JIC 37°

Raccordi JIC 37°

## Te Macho JIC 37°- Macho BSPT (60°) - Macho JIC 37°

Tee male JIC 37°-BSPT male 60°-male JIC 37°

Té mâle JIC 37° - mâle BSPT 60° - mâle JIC 37°

Raccordo a T JIC 37° orientabile centrale BSPT  
(M-M orientabile-M)

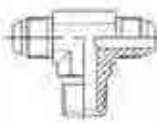

PIPE TUBO	THREAD ROSCA	Part n° Referencia	€
6	7/16" 20h UNF	<b>S6810604</b>	<b>4,91</b>
8	1/2" 20h UNF	<b>S6810804</b>	<b>6,86</b>
10	9/16" 18h UNF	<b>S6811004</b>	<b>5,42</b>
10	9/16" 18h UNF	<b>S6811006</b>	<b>6,57</b>
12	3/4" 16h UNF	<b>S6811206</b>	<b>8,81</b>
12	3/4" 16h UNF	<b>S6811208</b>	<b>9,25</b>
14-15-16	7/8" 14h UNF	<b>S6811608</b>	<b>9,75</b>
18-20	1" 1/16 12 h UNF	<b>S6812012</b>	<b>12,86</b>
25	1" 5/16 12 h UNF	<b>S6812516</b>	<b>24,20</b>

## Te Macho JIC 37° - Macho NPT (60°) - Macho JIC 37°

Tee male JIC 37°-NPT male 60°-male JIC 37°

Té mâle JIC 37° - mâle NPT 60° - mâle JIC 37°

Raccordo a T JIC 37° orientabile centrale NPT  
(M-M orientabile-M)

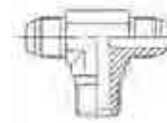

PIPE TUBO	THREAD ROSCA	Part n° Referencia	€
6	7/16" 20h UNF	<b>S6950604</b>	<b>4,12</b>
8	1/2" 20h UNF	<b>S6950804</b>	<b>4,48</b>
10	9/16" 18h UNF	<b>S6951004</b>	<b>4,98</b>
10	9/16" 18h UNF	<b>S6951006</b>	<b>6,28</b>
12	3/4" 16h UNF	<b>S6951206</b>	<b>6,72</b>
12	3/4" 16h UNF	<b>S6951208</b>	<b>7,80</b>
14-15-16	7/8" 14h UNF	<b>S6951608</b>	<b>9,75</b>
18-20	1" 1/16 12 h UNF	<b>S6952012</b>	<b>12,79</b>
25	1" 5/16 12 h UNF	<b>S6952516</b>	<b>24,20</b>

Pipe

DIN 2353 Pipe Fittings

Gas tube fittings

JIC 37° fittings

SAE Flanges

Clamps

Machines for  
processing rigid pipes

## Bridas SAE

*SAE Flanges*

Brides de fixation SAE

*Flangia SAE*

## Bridas SAE

*SAE Flanges*

Brides de fixation SAE

*Flange SAE*

224

5

# Bridas SAE

SAE Flanges  
Brides de fixation SAE  
Flange SAE

## ■ Bridas Roscadas / Threaded flanges / Brides taraudées / Flangia filettate

| 224

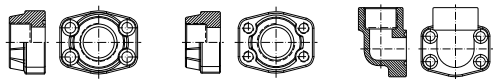

BBRG

BCRG

B90RG

## ■ Bridas soldables tubo gas / Welding flanges for gas tube / Brides à souder pour tube gaz / Flangia a saldare per tubo gas

| 225

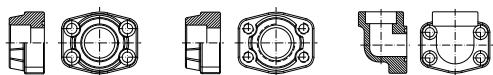

BBSG

BCSG

B90SG

## ■ Bridas soldables tubo métrico / Welding flanges for metric tube / Brides à souder pour tube métrique / Flangia a saldare per tubo Metrico

| 226

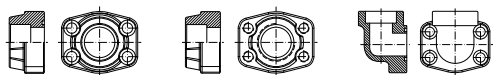

BBSM

BCSM

B90SM

## ■ Bridas soldables macho / Male welding flanges / Brides à souder mâle / Flangia a saldare maschio

| 227

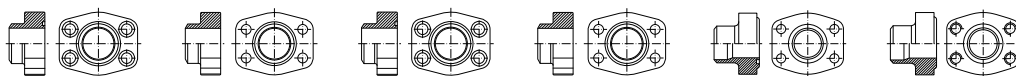

BMSG

BMSG

BMSM

BCMSM

BMSLM

BCMSLM

## ■ Accesorios bridas / Flange accessories / Accessoires pour brides / Accessori flangia

| 229



TBSAE

JBR

## ■ Bridas roscadas macho / Male threaded flanges / Brides taraudées mâle / Flangia filettate maschio

| 229

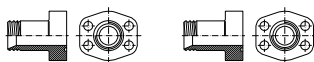

BMRG

BMRM

## ■ Bridas ciegas / Blind flanges / Brides avec obturateur fermé / Flangia cieche

| 230

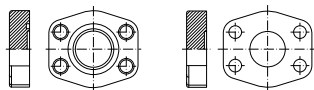

BBC

BCC

## ■ Bridas para flexibles / SAE Flanges for hoses / Brides SAE pour flexibles / Flangia SAE per tubi flessibili

| 231

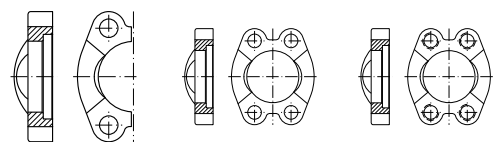

BBP

BBE

BCE

# Bridas SAE

SAE Flanges  
Brides de fixation SAE  
Flange SAE

## ■ Conos soldar / Welding adaptors for flanges / Collets à souder / Ogive a saldare

232

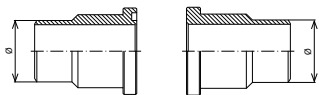

BSM31/61

BSM30/60

## ■ Bridas Cetop / Cetop flanges / Brides Cetop / Flangia Cetop

232

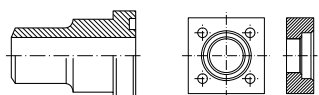

BCTS

BCT

Pipe

DIN 2353 Pipe Fittings

Gas tube fittings

JIC 37° fittings

SAE Flanges

Clamps

Machines for processing rigid pipes

# Bridas SAE

SAE Flanges  
Brides de fixation SAE  
Flange SAE

## Brida roscada hembra BSP

BSP Female threaded flange

Bride taraudée femelle BSP

Flangia filettata femmina BSP

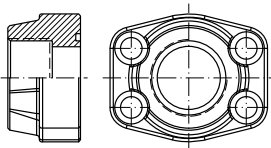

SERIE	THREAD ROSCA	SIZE TAMAÑO	Part nº Referencia	€
3000 PSI	1/2" BSP	1/2"	<b>BBRG30808</b>	<b>12,63</b>
3000 PSI	3/8" BSP	1/2"	<b>BBRG30806</b>	<b>12,63</b>
3000 PSI	3/4" BSP	3/4"	<b>BBRG31212</b>	<b>14,40</b>
3000 PSI	1/2" BSP	3/4"	<b>BBRG31208</b>	<b>14,40</b>
3000 PSI	1" BSP	1"	<b>BBRG31616</b>	<b>16,67</b>
3000 PSI	3/4" BSP	1"	<b>BBRG31612</b>	<b>16,67</b>
3000 PSI	1"1/4 BSP	1"1/4	<b>BBRG32020</b>	<b>20,80</b>
3000 PSI	1" BSP	1"1/4	<b>BBRG32016</b>	<b>20,80</b>
3000 PSI	1"1/2 BSP	1"1/2	<b>BBRG32424</b>	<b>24,03</b>
3000 PSI	1"1/4 BSP	1"1/2	<b>BBRG32420</b>	<b>27,21</b>
3000 PSI	2" BSP	2"	<b>BBRG33232</b>	<b>33,72</b>
3000 PSI	1"1/2 BSP	2"	<b>BBRG33224</b>	<b>27,42</b>
3000 PSI	2"1/2 BSP	2"1/2	<b>BBRG34040</b>	<b>45,97</b>
3000 PSI	2" BSP	2"1/2	<b>BBRG34032</b>	<b>45,97</b>
3000 PSI	2"1/2 BSP	3"	<b>BBRG34840</b>	<b>45,61</b>
3000 PSI	3" BSP	3"	<b>BBRG34848</b>	<b>41,71</b>
3000 PSI	3"1/2 BSP	3"1/2	<b>BBRG35656</b>	<b>90,50</b>
3000 PSI	3" BSP	3"1/2	<b>BBRG35648</b>	<b>80,88</b>
3000 PSI	4" BSP	4"	<b>BBRG36464</b>	<b>72,67</b>
3000 PSI	3"1/2 BSP	4"	<b>BBRG36456</b>	<b>87,67</b>
6000 PSI	1/2" BSP	1/2"	<b>BBRG60808</b>	<b>13,21</b>
6000 PSI	3/8" BSP	1/2"	<b>BBRG60806</b>	<b>13,21</b>
6000 PSI	3/4" BSP	3/4"	<b>BBRG61212</b>	<b>19,70</b>
6000 PSI	1/2" BSP	3/4"	<b>BBRG61208</b>	<b>19,70</b>
6000 PSI	1" BSP	1"	<b>BBRG61616</b>	<b>24,03</b>
6000 PSI	3/4" BSP	1"	<b>BBRG61612</b>	<b>24,03</b>
6000 PSI	1"1/4 BSP	1"1/4	<b>BBRG62020</b>	<b>34,28</b>
6000 PSI	1" BSP	1"1/4	<b>BBRG62016</b>	<b>34,28</b>
6000 PSI	1"1/4 BSP	1"1/2	<b>BBRG62420</b>	<b>57,09</b>
6000 PSI	1"1/2 BSP	1"1/2	<b>BBRG62424</b>	<b>57,09</b>
6000 PSI	2" BSP	2"	<b>BBRG63232</b>	<b>82,56</b>
6000 PSI	1"1/2 BSP	2"	<b>BBRG63224</b>	<b>82,56</b>

## Contrabrida roscada hembra BSP

BSP Female threaded counter-flange

Contre-bride taraudée femelle BSP

Controflangia filettata femmina BSP

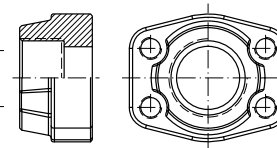

SERIE	THREAD ROSCA	SIZE TAMAÑO	Part nº Referencia	€
3000 PSI	1/2" BSP	1/2"	<b>BCRG30808</b>	<b>12,63</b>
3000 PSI	3/8" BSP	1/2"	<b>BCRG30806</b>	<b>14,57</b>
3000 PSI	3/4" BSP	3/4"	<b>BCRG31212</b>	<b>14,40</b>
3000 PSI	1/2" BSP	3/4"	<b>BCRG31208</b>	<b>14,22</b>
3000 PSI	1" BSP	1"	<b>BCRG31616</b>	<b>16,59</b>
3000 PSI	3/4" BSP	1"	<b>BCRG31612</b>	<b>16,45</b>
3000 PSI	1"1/4 BSP	1"1/4	<b>BCRG32020</b>	<b>21,98</b>
3000 PSI	1" BSP	1"1/4	<b>BCRG32016</b>	<b>22,08</b>
3000 PSI	1"1/2 BSP	1"1/2	<b>BCRG32424</b>	<b>25,26</b>
3000 PSI	1"1/4 BSP	1"1/2	<b>BCRG32420</b>	<b>33,90</b>
3000 PSI	2" BSP	2"	<b>BCRG33232</b>	<b>28,51</b>
3000 PSI	1"1/2 BSP	2"	<b>BCRG33224</b>	<b>31,68</b>
3000 PSI	2"1/2 BSP	2"1/2	<b>BCRG34040</b>	<b>45,68</b>
3000 PSI	2" BSP	2"1/2	<b>BCRG34032</b>	<b>47,14</b>
3000 PSI	3" BSP	3"	<b>BCRG34848</b>	<b>51,99</b>
3000 PSI	2"1/2 BSP	3"	<b>BCRG34840</b>	<b>56,84</b>
3000 PSI	3"1/2 BSP	3"1/2	<b>BCRG35656</b>	<b>74,07</b>
3000 PSI	3" BSP	3"1/2	<b>BCRG35648</b>	<b>64,88</b>
3000 PSI	4" BSP	4"	<b>BCRG36464</b>	<b>64,30</b>
3000 PSI	3"1/2 BSP	4"	<b>BCRG36456</b>	<b>70,29</b>
6000 PSI	1/2" BSP	1/2"	<b>BCRG60808</b>	<b>13,21</b>
6000 PSI	3/8" BSP	1/2"	<b>BCRG60806</b>	<b>13,21</b>
6000 PSI	3/4" BSP	3/4"	<b>BCRG61212</b>	<b>19,70</b>
6000 PSI	1/2" BSP	3/4"	<b>BCRG61208</b>	<b>19,70</b>
6000 PSI	1" BSP	1"	<b>BCRG61616</b>	<b>24,03</b>
6000 PSI	3/4" BSP	1"	<b>BCRG61612</b>	<b>22,66</b>
6000 PSI	1"1/4 BSP	1"1/4	<b>BCRG62020</b>	<b>34,28</b>
6000 PSI	1" BSP	1"1/4	<b>BCRG62016</b>	<b>31,68</b>
6000 PSI	1"1/2 BSP	1"1/2	<b>BCRG62424</b>	<b>57,09</b>
6000 PSI	1"1/4 BSP	1"1/2	<b>BCRG62420</b>	<b>45,61</b>
6000 PSI	2" BSP	2"	<b>BCRG63232</b>	<b>82,56</b>
6000 PSI	1"1/2 BSP	2"	<b>BCRG63224</b>	<b>59,97</b>

## Brida codo 90° roscada hembra BSP

90° BSP female threaded flange

Bride 90° taraudée femelle BSP

Flangia a 90° filettata femmina BSP

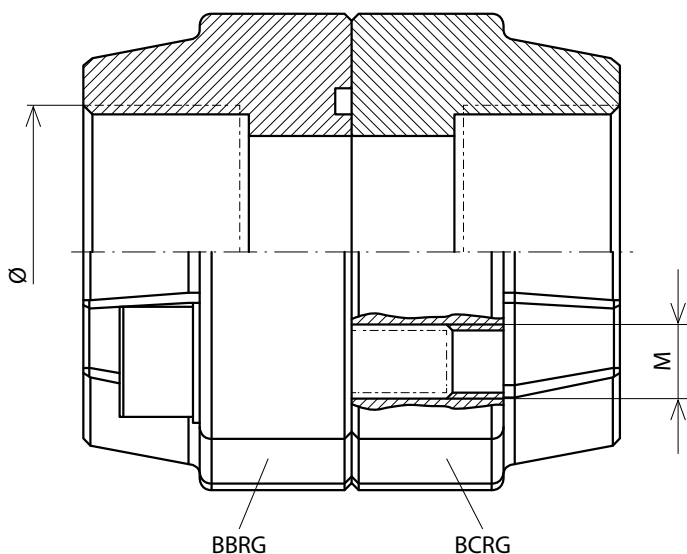
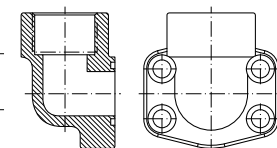

SERIE	THREAD ROSCA	SIZE TAMAÑO	Part nº Referencia	€
3000 PSI	1/2" BSP	1/2"	<b>B90RG30808</b>	<b>28,80</b>
3000 PSI	3/8" BSP	1/2"	<b>B90RG30806</b>	<b>30,60</b>
3000 PSI	3/4" BSP	3/4"	<b>B90RG31212</b>	<b>33,13</b>
3000 PSI	1" BSP	1"	<b>B90RG31616</b>	<b>35,44</b>
3000 PSI	1"1/4 BSP	1"1/4	<b>B90RG32020</b>	<b>41,35</b>
3000 PSI	1"1/2 BSP	1"1/2	<b>B90RG32424</b>	<b>52,83</b>
3000 PSI	2" BSP	2"	<b>B90RG33232</b>	<b>63,87</b>
6000 PSI	1/2" BSP	1/2"	<b>B90RG60808</b>	<b>33,56</b>
6000 PSI	3/8" BSP	1/2"	<b>B90RG60806</b>	<b>33,56</b>
6000 PSI	3/4" BSP	3/4"	<b>B90RG61212</b>	<b>35,65</b>
6000 PSI	1" BSP	1"	<b>B90RG61616</b>	<b>40,99</b>
6000 PSI	1"1/4 BSP	1"1/4	<b>B90RG62020</b>	<b>52,25</b>
6000 PSI	1"1/2 BSP	1"1/2	<b>B90RG62424</b>	<b>63,29</b>



# Bridas SAE

SAE Flanges  
Brides de fixation SAE  
Flange SAE

## Brida soldable hembra tubo gas

Welding female flange for gas tube

Bride à souder femelle tube gaz

Flangia femmina a saldare per tubo gas

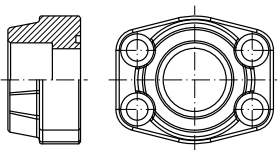

SERIE	Ø INNER Ø INT.	SIZE TAMAÑO	Part nº Referencia	€
3000 PSI	21.6	1/2"	BBSG308216	10,12
3000 PSI	17.5	1/2"	BBSG308175	16,25
3000 PSI	27.2	3/4"	BBSG312272	12,34
3000 PSI	34	1"	BBSG316340	14,22
3000 PSI	42.8	1"1/4	BBSG320428	18,84
3000 PSI	48.6	1"1/2	BBSG324486	25,26
3000 PSI	61	2"	BBSG332610	28,51
3000 PSI	76.6	2"1/2	BBSG340766	45,68
3000 PSI	90.5	3"	BBSG348905	39,48
3000 PSI	103	3"1/2	BBSG3561030	56,15
3000 PSI	115.5	4"	BBSG341155	102,77
6000 PSI	17.5	1/2"	BBSG608175	14,72
6000 PSI	21.6	1/2"	BBSG608216	14,72
6000 PSI	27.2	3/4"	BBSG612272	19,70
6000 PSI	34	1"	BBSG621612	24,03
6000 PSI	42.8	1"1/4	BBSG620428	34,28
6000 PSI	48.6	1"1/2	BBSG624486	57,09
6000 PSI	61	2"	BBSG632610	82,56

## Contrabrida soldable hembra tubo gas

Welding female counter-flange for gas tube

Contre-bride à souder femelle tube gaz

Controflangia femmina a saldare per tubo gas

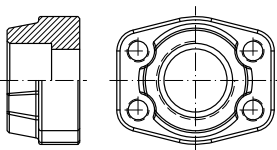

SERIE	Ø INNER Ø INT.	SIZE TAMAÑO	Part nº Referencia	€
3000 PSI	21.6	1/2"	BCSG308216	13,06
3000 PSI	17.5	1/2"	BCSG308175	10,83
3000 PSI	27.2	3/4"	BCSG312272	12,34
3000 PSI	34	1"	BCSG316340	14,22
3000 PSI	42.8	1"1/4	BCSG320428	18,84
3000 PSI	48.6	1"1/2	BCSG324486	25,26
3000 PSI	61	2"	BCSG332610	28,51
3000 PSI	76.6	2"1/2	BCSG340766	32,77
3000 PSI	90.5	3"	BCSG348905	49,20
3000 PSI	103	3"1/2	BCSG3561030	56,15
3000 PSI	115.5	4"	BCSG3641155	59,97
6000 PSI	21.6	1/2"	BCSG608216	14,72
6000 PSI	27.2	3/4"	BCSG612272	19,70
6000 PSI	34	1"	BCSG616340	24,03
6000 PSI	42.8	1"1/4	BCSG620428	34,28
6000 PSI	48.6	1"1/2	BCSG624486	57,09
6000 PSI	61	2"	BCSG632610	82,56

## Brida codo 90° soldable hembra tubo gas

90° welding female flange for gas tube

Bride 90° à souder femelle tube gaz

Flangia a 90° femmina a saldare per tubo gas

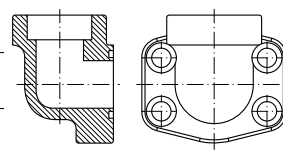

SERIE	Ø INNER Ø INT.	SIZE TAMAÑO	Part nº Referencia	€
3000 PSI	21.6	1/2"	B90SG308216	35,35
3000 PSI	17.5	1/2"	B90SG308175	35,35
3000 PSI	27.2	3/4"	B90SG312272	38,13
3000 PSI	34	1"	B90SG316340	42,29
3000 PSI	42.8	1"1/4	B90SG320428	39,48
3000 PSI	48.6	1"1/2	B90SG324486	48,35
3000 PSI	61	2"	B90SG332610	58,89
6000 PSI	21.6	1/2"	B90SG608216	38,13
6000 PSI	17.5	1/2"	B90SG608175	38,13
6000 PSI	27.2	3/4"	B90SG612272	33,92
6000 PSI	34	1"	B90SG616340	39,48
6000 PSI	42.8	1"1/4	B90SG620428	60,29
6000 PSI	48.6	1"1/2	B90SG624486	73,45

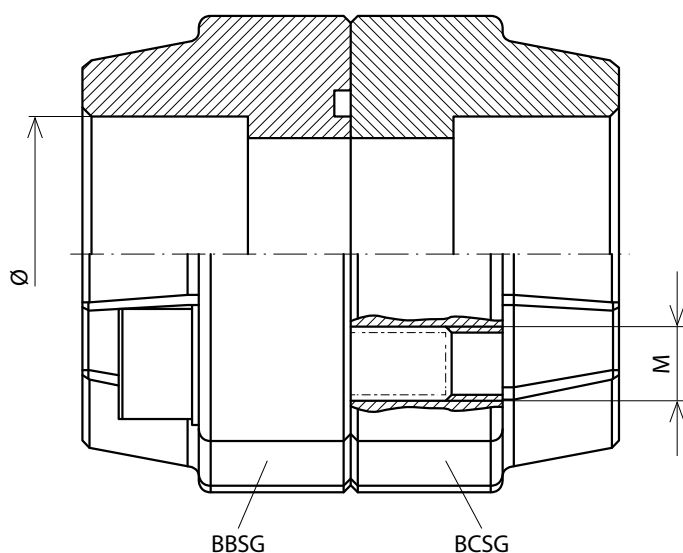

BBSG

BCSG

# Bridas SAE

SAE Flanges  
Brides de fixation SAE  
Flange SAE

## Brida soldable hembra tubo métrico

Female welding flange for metric tube

Bride à souder femelle tube métrique

Flangia femmina a saldare per tubo Metrico

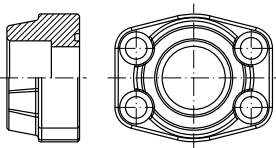

SERIE	Ø INNER Ø INT.	SIZE TAMAÑO	Part nº Referencia	€
3000 PSI	20.3	1/2"	<b>BBSM308203</b>	<b>16,25</b>
3000 PSI	25.3	3/4"	<b>BBSM312253</b>	<b>13,57</b>
3000 PSI	30.3	1"	<b>BBSM316303</b>	<b>15,88</b>
3000 PSI	38.3	1"1/4	<b>BBSM320383</b>	<b>18,12</b>
3000 PSI	50.5	1"1/2	<b>BBSM324505</b>	<b>23,24</b>
6000 PSI	20.3	1/2"	<b>BBSM608203</b>	<b>18,37</b>
6000 PSI	25.3	3/4"	<b>BBSM612253</b>	<b>19,79</b>
6000 PSI	30.3	1"	<b>BBSM616303</b>	<b>18,69</b>
6000 PSI	38.3	1"1/4	<b>BBSM620383</b>	<b>26,13</b>
6000 PSI	50.5	1"1/2	<b>BBSM624505</b>	<b>38,90</b>

## Brida codo 90° soldable hembra tubo métrico

90° female welding flange for metric tube

Bride 90° à souder femelle tube métrique

Flangia a 90° femmina a saldare per tubo Metrico

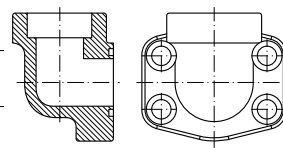

SERIE	Ø INNER Ø INT.	SIZE TAMAÑO	Part nº Referencia	€
3000 PSI	20.3	1/2"	<b>B90SM308203</b>	<b>35,35</b>
3000 PSI	25.3	3/4"	<b>B90SM312253</b>	<b>38,13</b>
3000 PSI	30.3	1"	<b>B90SM316303</b>	<b>42,29</b>
3000 PSI	38.3	1"1/4	<b>B90SM320383</b>	<b>49,20</b>
3000 PSI	50.5	1"1/2	<b>B90SM324505</b>	<b>60,29</b>
6000 PSI	20.3	1/2"	<b>B90SM608203</b>	<b>38,13</b>
6000 PSI	25.3	3/4"	<b>B90SM612253</b>	<b>42,29</b>
6000 PSI	30.3	1"	<b>B90SM616303</b>	<b>39,48</b>
6000 PSI	38.3	1"1/4	<b>B90SM620383</b>	<b>48,35</b>
6000 PSI	50.3	1"1/2	<b>B90SM624503</b>	<b>58,89</b>

## Contrabrida soldable hembra tubo métrico

Female welding counter-flange for metric tube

Contre-bride à souder femelle tube métrique

Controflangia femmina a saldare per tubo Metrico

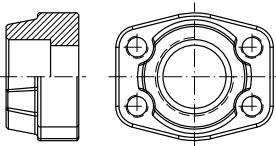

SERIE	Ø INNER Ø INT.	SIZE TAMAÑO	Part nº Referencia	€
3000 PSI	20.3	1/2"	<b>BCSM308203</b>	<b>16,25</b>
3000 PSI	25.3	3/4"	<b>BCSM312253</b>	<b>13,57</b>
3000 PSI	30.3	1"	<b>BCSM316303</b>	<b>15,88</b>
3000 PSI	38.3	1"1/4	<b>BCSM320383</b>	<b>18,12</b>
6000 PSI	20.3	1/2"	<b>BCSM608203</b>	<b>14,72</b>
6000 PSI	25.3	3/4"	<b>BCSM612253</b>	<b>15,88</b>
6000 PSI	30.3	1"	<b>BCSM616303</b>	<b>18,69</b>
6000 PSI	38.3	1"1/4	<b>BCSM620383</b>	<b>26,13</b>
6000 PSI	50.5	1"1/2	<b>BCSM624505</b>	<b>38,90</b>

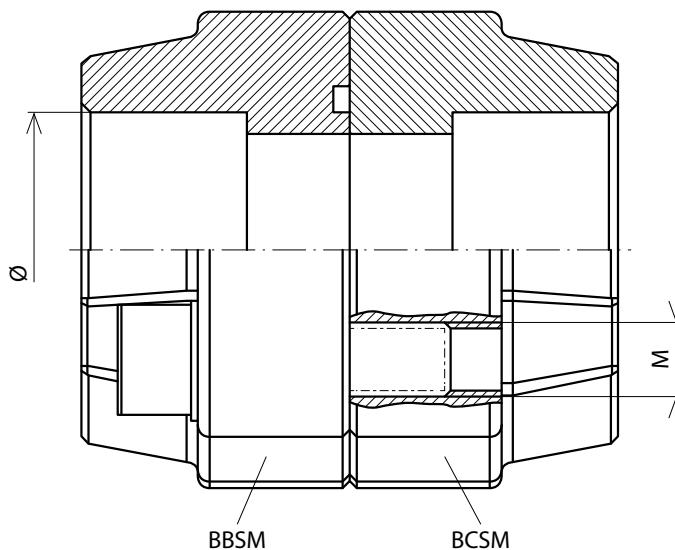

# Bridas SAE

SAE Flanges  
Brides de fixation SAE  
Flange SAE

Pipe

DIN 2353 Pipe Fittings

Gas tube fittings

JIC 37° fittings

SAE Flanges

Clamps

Machines for processing rigid pipes

## Brida soldable macho tubo gas

Male welding flange for gas tube

Bride à souder mâle tube gaz

Flangia a saldare maschio tubo gas

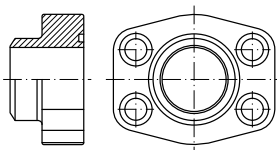

SERIE	Ø OUTER Ø EXT.	SIZE TAMAÑO	Part nº Referencia	€
3000 PSI	21.5	1/2"	BMSG308215	13,06
3000 PSI	17.5	1/2"	BMSG308175	13,06
3000 PSI	28	3/4"	BMSG312280	16,95
3000 PSI	34	1"	BMSG316340	15,88
3000 PSI	42.8	1"1/4	BMSG320428	22,60
3000 PSI	48.6	1"1/2	BMSG324486	28,97
3000 PSI	61	2"	BMSG332610	27,79
3000 PSI	77	2"1/2	BMSG340770	32,77
3000 PSI	92	3"	BMSG348920	39,48
3000 PSI	103	3"1/2	BMSG356103	56,15
6000 PSI	21.5	1/2"	BMSG608215	14,72
6000 PSI	17.5	1/2"	BMSG608175	14,72
6000 PSI	28	3/4"	BMSG612280	19,79
6000 PSI	34	1"	BMSG616340	23,32
6000 PSI	42.8	1"1/4	BMSG620428	32,58
6000 PSI	48.6	1"1/2	BMSG624486	48,50
6000 PSI	61	2"	BMSG632610	51,24

## Contrabrida soldable macho tubo gas

Male welding counter-flange for gas tube

Contre-bride à souder mâle tube gaz

Controflangia a saldare maschio tubo gas

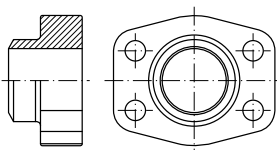

SERIE	Ø OUTER Ø EXT.	SIZE TAMAÑO	Part nº Referencia	€
3000 PSI	21.5	1/2"	BCMSG308215	13,06
3000 PSI	17.5	1/2"	BCMSG308175	13,06
3000 PSI	28	3/4"	BCMSG312280	16,95
3000 PSI	34	1"	BCMSG316340	19,79
3000 PSI	42.8	1"1/4	BCMSG320428	22,60
3000 PSI	48.6	1"1/2	BCMSG324486	23,24
3000 PSI	61	2"	BCMSG332610	27,79
3000 PSI	77	2"1/2	BCMSG340770	40,89
3000 PSI	92	3"	BCMSG348920	39,48
3000 PSI	103	3"1/2	BCMSG561030	56,15
3000 PSI	115.5	4"	BCMSG3641155	59,97
6000 PSI	21.5	1/2"	BCMSG608215	14,72
6000 PSI	17.5	1/2"	BCMSG608175	14,72
6000 PSI	28	3/4"	BCMSG612280	15,88
6000 PSI	34	1"	BCMSG616340	23,31
6000 PSI	42.8	1"1/4	BCMSG620428	26,13
6000 PSI	48.6	1"1/2	BCMSG624486	38,90
6000 PSI	61	2"	BCMSG632610	51,24

## Brida soldable macho tubo métrico

Male welding flange for metric tube

Bride à souder mâle tube métrique

Flangia a saldare maschio tubo Metrico

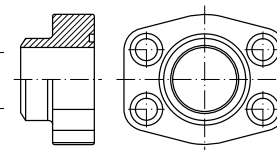

SERIE	Ø OUTER Ø EXT.	SIZE TAMAÑO	Part nº Referencia	€
3000 PSI	25	3/4"	BMSM31225	16,95
3000 PSI	30	1"	BMSM31630	19,79
3000 PSI	38	1"1/4	BMSM32038	22,60
3000 PSI	42	1"1/2	BMSM32442	28,97
3000 PSI	61	2"	BMSM33261	27,79
3000 PSI	49	2"	BMSM33249	27,79
3000 PSI	77	3"	BMSM34877	39,48
3000 PSI	77	3"	BMSM34877T *	39,48
3000 PSI	77	3"1/2	BMSM35677	69,99
3000 PSI	90	3"1/2	BMSM35690	69,99
3000 PSI	77	4"	BMSM36477	59,97
3000 PSI	90	4"	BMSM36490	59,97
6000 PSI	20	1/2"	BMSM60820	14,72
6000 PSI	20	3/4"	BMSM61220	19,79
6000 PSI	25	3/4"	BMSM61225	19,79
6000 PSI	25	1"	BMSM61625	23,32
6000 PSI	30	1"	BMSM61630	23,32
6000 PSI	38	1"1/4	BMSM62038	32,58
6000 PSI	38	1"1/2	BMSM62438	48,50
6000 PSI	61	2"	BMSM63261	51,24

\*Hasta fin de existencias. / \*Until end of stock. / \*Jusqu'à la fin du stock. / \*Fino ad esaurimento scorta.

## Contrabrida soldable macho tubo métrico

Male welding counter-flange for metric tube

Contre-bride à souder mâle tube métrique

Controflangia a saldare maschio tubo Metrico

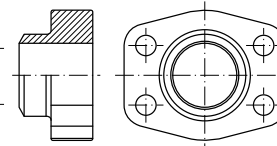

SERIE	Ø OUTER Ø EXT.	SIZE TAMAÑO	Part nº Referencia	€
3000 PSI	25	3/4"	BCMSM31225	13,57
3000 PSI	30	1"	BCMSM31630	15,88
3000 PSI	38	1"1/4	BCMSM32038	22,60
3000 PSI	42	1"1/2	BCMSM32442	23,24
3000 PSI	49	1"1/2	BCMSM32449	28,97
3000 PSI	61	2"	BCMSM33261	27,79
3000 PSI	49	2"	BCMSM33249	34,65
3000 PSI	77	2"1/2	BCMSM34077	32,77
3000 PSI	77	3"	BCMSM34877	39,48
3000 PSI	77	3"	BCMSM34877T *	39,48
3000 PSI	77	3"1/2	BCMSM35677	56,15
3000 PSI	90	3"1/2	BCMSM35690	56,15
3000 PSI	90	4"	BCMSM36490	59,97
6000 PSI	20	1/2"	BCMSM60820	14,72
6000 PSI	20	3/4"	BCMSM61220	19,79
6000 PSI	25	3/4"	BCMSM61225	19,79
6000 PSI	25	1"	BCMSM61625	23,32
6000 PSI	30	1"	BCMSM61630	23,32
6000 PSI	38	1"1/4	BCMSM62038	32,58
6000 PSI	38	1"1/2	BCMSM62438	48,50
6000 PSI	61	2"	BCMSM63261	51,24

\*Hasta fin de existencias. / \*Until end of stock. / \*Jusqu'à la fin du stock. / \*Fino ad esaurimento scorta.

# Bridas SAE

SAE Flanges  
Brides de fixation SAE  
Flange SAE

## Brida soldable macho serie L tubo métrico

Male welding flange L serie for metric tube

Bride à souder mâle série L tube métrique

Flangia a saldare maschio serie L tubo Metrico

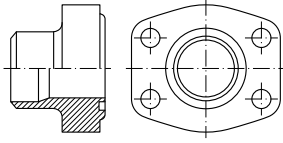

SERIE	Ø OUTER Ø EXT.	SIZE TAMAÑO	Part n° Referencia	€
3000 PSI	20	1/2"	<b>BMSLM30820</b>	<b>16,25</b>
3000 PSI	22	1/2"	<b>BMSLM30822</b>	<b>16,25</b>
3000 PSI	28	3/4"	<b>BMSLM31228</b>	<b>16,95</b>
3000 PSI	35	1"	<b>BMSLM31635</b>	<b>19,79</b>
3000 PSI	43	1"1/4	<b>BMSLM32043</b>	<b>22,60</b>
3000 PSI	49	1"1/2	<b>BMSLM32449</b>	<b>28,97</b>
3000 PSI	61	2"	<b>BMSLM33261</b>	<b>34,65</b>
3000 PSI	77	2"1/2	<b>BMSLM34077</b>	<b>32,77</b>
3000 PSI	90	3"	<b>BMSLM34890</b>	<b>49,20</b>
3000 PSI	115	4"	<b>BMSLM364115</b>	<b>59,97</b>

## Contrabrida soldable macho serie L tubo métrico

Male welding counter-flange L serie for metric tube

Contre-bride à souder mâle série L tube métrique

Controflangia a saldare maschio serie L tubo Metrico

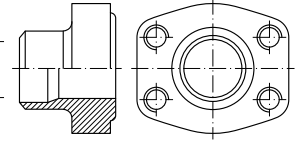

SERIE	Ø OUTER Ø EXT.	SIZE TAMAÑO	Part n° Referencia	€
3000 PSI	20	1/2"	<b>BCMSLM30820</b>	<b>16,25</b>
3000 PSI	22	1/2"	<b>BCMSLM30822</b>	<b>16,25</b>
3000 PSI	28	3/4"	<b>BCMSLM31228</b>	<b>16,95</b>
3000 PSI	35	1"	<b>BCMSLM31635</b>	<b>19,79</b>
3000 PSI	43	1"1/4	<b>BCMSLM32043</b>	<b>22,60</b>
3000 PSI	49	1"1/2	<b>BCMSLM32449</b>	<b>28,97</b>
3000 PSI	61	2"	<b>BCMSLM33261</b>	<b>27,79</b>
3000 SPI	77	2"1/2	<b>BCMSLM34077</b>	<b>32,77</b>
3000 PSI	90	3"	<b>BCMSLM34890</b>	<b>39,48</b>
3000 PSI	115	4"	<b>BCMSLM364115</b>	<b>59,97</b>

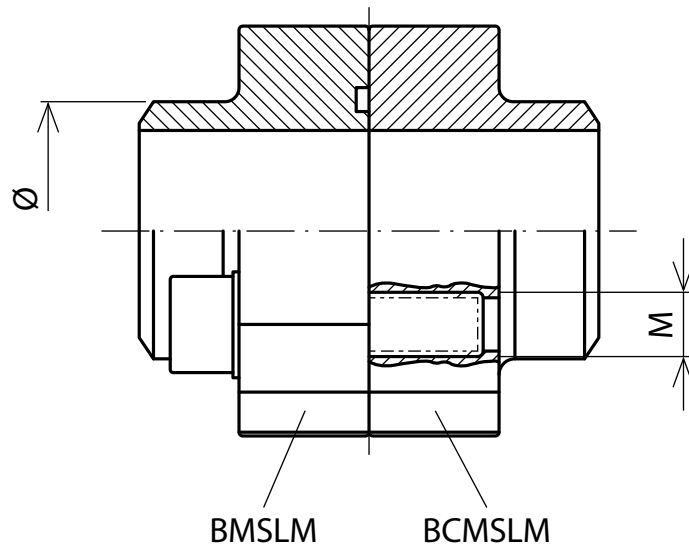

# Bridas SAE

SAE Flanges  
Brides de fixation SAE  
Flange SAE

## Tornillos para bridas SAE

Screws for SAE flanges

Vis pour brides SAE

Vite per flangia SAE



THREAD ROSCA	SIZE TAMAÑO	Part nº Referencia	€
M8X30	3000-6000 PSI 1/2"	<b>TB8X30</b>	<b>0,17</b>
M10X35	3000 PSI 3/4"-1"	<b>TB10X35</b>	<b>0,32</b>
M10X40	3000 PSI 1" 1/4 - 6000 PSI 3/4"	<b>TB10X40</b>	<b>0,33</b>
M12X35	3000 PSI 1"1/2-2"-2"1/2-6000 PSI 1"	<b>TB12X45</b>	<b>0,50</b>
M14X45	6000 PSI 1"1/4	<b>TB14X45</b>	<b>0,82</b>
M16X50	3000 PSI 3"-3"1/2"-4"- 6000 PSI 1" 1/2	<b>TB16X50</b>	<b>1,21</b>
M20X70	6000 PSI 2"	<b>TB20X70</b>	<b>1,85</b>

## Juntas para bridas SAE 3000/6000 PSI

Seals for 3000/6000 PSI flange

Joints pour bride série 3000/6000

Guarnizioni per flangia SAE 3000/6000 PSI



Ø OUTER Ø EXT.	Ø INNER Ø INT.	SIZE TAMAÑO	HEIGHT (MM) ALTURA (MM)	Part nº Referencia	€
25.40	17.02	1/2"	2.79	<b>JBR08</b>	*
31.72	23.36	3/4"	2.79	<b>JBR12</b>	*
39.62	31.24	1"	2.79	<b>JBR16</b>	*
44.45	36.07	1"1/4	2.79	<b>JBR20</b>	*
53.98	45.34	1"1/2	2.79	<b>JBR24</b>	*
63.50	54.86	2"	2.79	<b>JBR32</b>	*

\*Ver precios en p.48 / \*See prices page 48 / \*Voir les prix page 48 / \*Vedere prezzi p.48

## Brida roscada macho BSP

BSP Male threaded flange

Brides taraudées mâle BSP

Flangia maschio filettata BSP

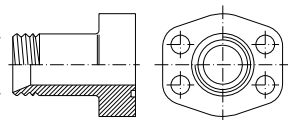

SERIE	THREAD ROSCA	SIZE TAMAÑO	Part nº Referencia	€
3000 PSI	3/8" BSP	1/2"	<b>BMRG30806</b>	<b>27,55</b>
3000 PSI	1/2" BSP	1/2"	<b>BMRG30808</b>	<b>24,02</b>
3000 PSI	3/4" BSP	3/4"	<b>BMRG31212</b>	<b>24,39</b>
3000 PSI	1/2" BSP	3/4"	<b>BMRG31208</b>	<b>24,39</b>
3000 PSI	1" BSP	1"	<b>BMRG31616</b>	<b>16,67</b>
3000 PSI	3/4" BSP	1"	<b>BMRG31612</b>	<b>16,67</b>
3000 PSI	1"1/4 BSP	1"1/4	<b>BMRG32020</b>	<b>20,80</b>
3000 PSI	1" BSP	1"1/4	<b>BMRG32016</b>	<b>20,80</b>
3000 PSI	1"1/2 BSP	1"1/2	<b>BMRG32424</b>	<b>28,04</b>
3000 PSI	1"1/4 BSP	1"1/2	<b>BMRG32420</b>	<b>28,04</b>
6000 PSI	1/2" BSP	1/2"	<b>BMRG60808</b>	<b>26,14</b>
6000 PSI	3/8" BSP	1/2"	<b>BMRG60806</b>	<b>28,25</b>
6000 PSI	3/4" BSP	3/4"	<b>BMRG61212</b>	<b>22,99</b>
6000 PSI	1/2" BSP	3/4"	<b>BMRG61208</b>	<b>34,62</b>
6000 PSI	1" BSP	1"	<b>BMRG61616</b>	<b>28,04</b>
6000 PSI	3/4" BSP	1"	<b>BMRG61612</b>	<b>28,04</b>
6000 PSI	1"1/4 BSP	1"1/4	<b>BMRG62020</b>	<b>34,28</b>
6000 PSI	1" BSP	1"1/4	<b>BMRG62016</b>	<b>39,99</b>
6000 PSI	1"1/2 BSP	1"1/2	<b>BMRG62424</b>	<b>43,37</b>
6000 PSI	1"1/4 BSP	1"1/2	<b>BMRG62420</b>	<b>47,78</b>

## Brida roscada macho métrico

Metric Male threaded flange

Brides taraudées mâle Métrique

Flangia maschio filettata Metrica

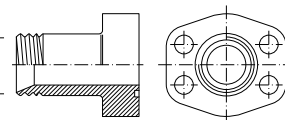

SERIE	THREAD ROSCA	SIZE TAMAÑO	Part nº Referencia	€
3000 PSI	M22x1,5	1/2"	<b>BMRM30822</b>	<b>27,22</b>
3000 PSI	M30x2	3/4"	<b>BMRM31230</b>	<b>31,23</b>
3000 PSI	M36x2	1"	<b>BMRM31636</b>	<b>36,84</b>
3000 PSI	M45x2	1"1/4	<b>BMRM32045</b>	<b>44,04</b>
3000 PSI	M52x2	1"1/2	<b>BMRM32452</b>	<b>52,84</b>
6000 PSI	M24x1.5	1/2"	<b>BMRM60824</b>	<b>29,62</b>
6000 PSI	M36X2	3/4"	<b>BMRM61236</b>	<b>36,02</b>
6000 PSI	M42x2	1"	<b>BMRM61642</b>	<b>44,04</b>
6000 PSI	M52x2	1"1/4	<b>BMRM62052</b>	<b>51,84</b>
6000 PSI	M52x2	1"1/2	<b>BMRM62452</b>	<b>61,26</b>

# Bridas SAE

SAE Flanges  
Brides de fixation SAE  
Flange SAE

## Bridas ciegas

Blind flanges

Brides avec obturateur fermé

Flangia cieche

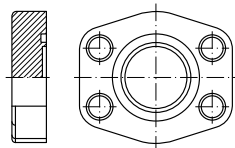

SERIE	SIZE TAMAÑO	Part nº Referencia	€
3000 PSI	1/2"	<b>BBC308</b>	<b>11,48</b>
3000 PSI	3/4"	<b>BBC312</b>	<b>10,18</b>
3000 PSI	1"	<b>BBC316</b>	<b>10,90</b>
3000 PSI	1"1/4	<b>BBC320</b>	<b>12,49</b>
3000 PSI	1"1/2	<b>BBC324</b>	<b>12,70</b>
3000 PSI	2"	<b>BBC332</b>	<b>25,76</b>
3000 PSI	2"1/2	<b>BBC340</b>	<b>21,49</b>
3000 PSI	3"	<b>BBC348</b>	<b>27,21</b>
3000 PSI	3"1/2	<b>BBC356</b>	<b>32,19</b>
3000 PSI	4"	<b>BBC364</b>	<b>34,35</b>
3000 PSI	5"	<b>BBC380</b>	<b>73,04</b>
6000 PSI	1/2"	<b>BBC608</b>	<b>11,33</b>
6000 PSI	3/4"	<b>BBC612</b>	<b>11,91</b>
6000 PSI	1"	<b>BBC616</b>	<b>13,57</b>
6000 PSI	1"1/4	<b>BBC620</b>	<b>16,09</b>
6000 PSI	1"1/2	<b>BBC624</b>	<b>18,91</b>
6000 PSI	2"	<b>BBC632</b>	<b>29,95</b>

## Contrabridas ciegas

Blind counter-flanges

Contre-brides avec obturateur fermé

Controflangia cieche

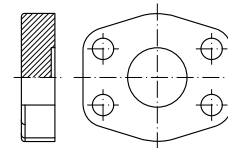

SERIE	SIZE TAMAÑO	Part nº Referencia	€
3000 PSI	1/2"	<b>BCC308</b>	<b>9,67</b>
3000 PSI	3/4"	<b>BCC312</b>	<b>10,18</b>
3000 PSI	1"	<b>BCC316</b>	<b>11,91</b>
3000 PSI	1"1/4	<b>BCC320</b>	<b>15,56</b>
3000 PSI	1"1/2	<b>BCC324</b>	<b>18,37</b>
3000 PSI	2"	<b>BCC332</b>	<b>15,01</b>
3000 PSI	2"1/2	<b>BCC340</b>	<b>21,49</b>
3000 PSI	3"	<b>BCC348</b>	<b>27,21</b>
3000 PSI	3"1/2	<b>BCC356</b>	<b>32,19</b>
3000 PSI	4"	<b>BCC364</b>	<b>42,83</b>
3000 PSI	5"	<b>BCC380</b>	<b>73,04</b>
6000 PSI	1/2"	<b>BCC608</b>	<b>11,33</b>
6000 PSI	3/4"	<b>BCC612</b>	<b>11,91</b>
6000 PSI	1"	<b>BCC616</b>	<b>13,57</b>
6000 PSI	1"1/4	<b>BCC620</b>	<b>16,09</b>
6000 PSI	1"1/2	<b>BCC624</b>	<b>18,91</b>
6000 PSI	2"	<b>BCC632</b>	<b>29,95</b>

# Bridas SAE

SAE Flanges  
Brides de fixation SAE  
Flange SAE

## Brida partida pasante

SAE Split flange

Demi-bride SAE passage total

Semiflangua SAE

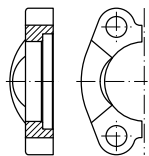

SERIE	SIZE TAMAÑO	Part nº Referencia	€
3000 PSI	1/2"	BBP308	*
3000 PSI	3/4"	BBP312	*
3000 PSI	1"	BBP316	*
3000 PSI	1"1/4	BBP320	*
3000 PSI	1"1/2	BBP324	*
3000 PSI	2"	BBP332	*
3000 PSI	2"1/2	BBP340	*
3000 PSI	3"	BBP348	*
3000 PSI	3"1/2	BBP356	*
3000 PSI	4"	BBP364	*
6000 PSI	1/2"	BBP608	*
6000 PSI	3/4"	BBP612	*
6000 PSI	1"	BBP616	*
6000 PSI	1"1/4	BBP620	*
6000 PSI	1"1/2	BBP624	*
6000 PSI	2"	BBP632	*

\*Ver precios en p.48 (Conexiones Standard) / \*See prices in p.48 (Standard Serie Fittings) / \*Prix à la p.48 (Embouts Série Standard) / \*Vedere prezzi p.48 (Raccordi Serie Standard)

## Contrabrida rosca Métrica

Metric threaded counter-flange

Contre-bride métrique

Controflangia filettata Metrica

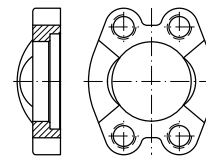

SERIE	SIZE TAMAÑO	Part nº Referencia	€
3000 PSI	1/2"	BCE308	10,91
3000 PSI	3/4"	BCE312	11,70
3000 PSI	1"	BCE316	13,45
3000 PSI	1"1/4	BCE320	15,85
3000 PSI	1"1/2	BCE324	18,42
3000 PSI	2"	BCE332	33,63
3000 PSI	2"1/2	BCE340	44,15
3000 PSI	3"	BCE348	63,77
3000 PSI	3"1/2	BCE356	94,59
3000 PSI	4"	BCE364	118,62
3000 PSI	5"	BCE380	144,18
6000 PSI	1/2"	BCE608	12,51
6000 PSI	3/4"	BCE612	13,45
6000 PSI	1"	BCE616	17,63
6000 PSI	1"1/4	BCE620	25,47
6000 PSI	1"1/2	BCE624	51,52
6000 PSI	2"	BCE632	72,10

## Brida entera pasante

SAE Flange

Bride SAE monobloc passage total

Flangia monoblocco SAE

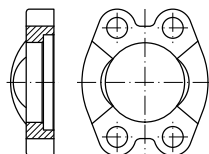

SERIE	SIZE TAMAÑO	Part nº Referencia	€
3000 PSI	1/2"	BBE308	*
3000 PSI	3/4"	BBE312	*
3000 PSI	1"	BBE316	*
3000 PSI	1"1/4	BBE320	*
3000 PSI	1"1/2	BBE324	*
3000 PSI	2"	BBE332	*
3000 PSI	2"1/2	BBE340	*
3000 PSI	3"	BBE348	*
3000 PSI	3"1/2	BBE356	*
3000 PSI	4"	BBE364	*
3000 PSI	5"	BBE380	*
6000 PSI	1/2"	BBE608	*
6000 PSI	3/4"	BBE612	*
6000 PSI	1"	BBE616	*
6000 PSI	1"1/4	BBE620	*
6000 PSI	1"1/2	BBE624	*
6000 PSI	2"	BBE632	*

\*Ver precios en p.48 (Conexiones Standard) / \*See prices in p.48 (Standard Serie Fittings) / \*Prix à la p.48 (Embouts Série Standard) / \*Vedere prezzi p.48 (Raccordi Serie Standard)

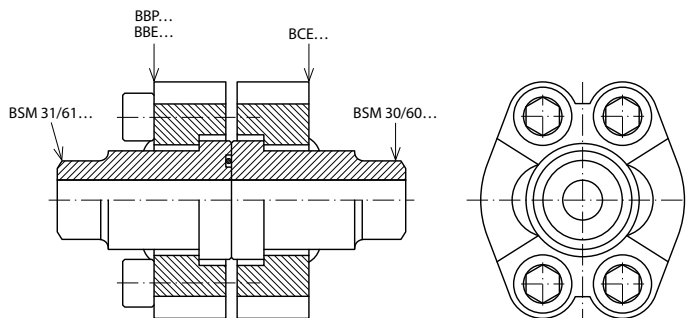

# Bridas SAE

SAE Flanges  
Brides de fixation SAE  
Flange SAE

## Brida cono soldable tubo métrico

Flange welding adaptor for metric tube

Bride collet à souder tube métrique

Flangia adattatore a saldare per tubo Metrico

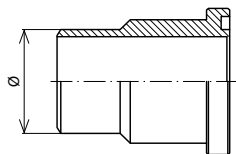

SERIE	Ø OUTER Ø EXT.	SIZE TAMAÑO	Part nº Referencia	€
3000 PSI	16	1/2"	<b>BSM310816</b>	*
3000 PSI	25	3/4"	<b>BSM311225</b>	<b>6,06</b>
3000 PSI	30	1"	<b>BSM311630</b>	<b>8,50</b>
3000 PSI	38	1"1/4	<b>BSM3132038</b>	<b>9,68</b>
3000 PSI	45	1"1/2	<b>BSM312445</b>	<b>12,12</b>
3000 PSI	60	2"	<b>BSM313260</b>	<b>14,57</b>
3000 PSI	70	2"1/2	<b>BSM314070</b>	<b>31,68</b>
3000 PSI	80	3"	<b>BSM314880</b>	<b>53,35</b>
3000 PSI	100	3"1/2	<b>BSM3156100</b>	<b>72,82</b>
3000 PSI	114.3	4"	<b>BSM31641143</b>	<b>81,70</b>
3000 PSI	139.7	5"	<b>BSM31801397</b>	<b>117,29</b>
6000 PSI	16	1/2"	<b>BSM610816</b>	<b>6,06</b>
6000 PSI	25	3/4"	<b>BSM611225</b>	<b>8,50</b>
6000 PSI	30	1"	<b>BSM611630</b>	<b>12,12</b>
6000 PSI	38	1"1/4	<b>BSM612038</b>	<b>14,57</b>
6000 PSI	45	1"1/2	<b>BSM612445</b>	<b>18,10</b>
6000 PSI	60	2"	<b>BSM613260</b>	<b>24,16</b>

## Contrabrida cono soldable tubo métrico

Counter-flange welding adaptor for metric tube

Contrebride collet à souder tube métrique

Controflangia adattatore a saldare per tubo Metrico

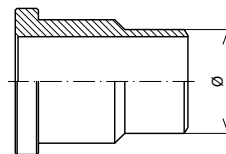

SERIE	Ø OUTER Ø EXT.	SIZE TAMAÑO	Part nº Referencia	€
3000 PSI	16	1/2"	<b>BSM300816</b>	<b>9,45</b>
3000 PSI	25	3/4"	<b>BSM301225</b>	<b>10,54</b>
3000 PSI	30	1"	<b>BSM301630</b>	<b>11,11</b>
3000 PSI	38	1"1/4	<b>BSM302038</b>	<b>14,43</b>
3000 PSI	45	1"1/2	<b>BSM302445</b>	<b>18,33</b>
3000 PSI	60	2"	<b>BSM303260</b>	<b>23,89</b>
3000 PSI	70	2"1/2	<b>BSM304070</b>	<b>31,68</b>
3000 PSI	80	3"	<b>BSM304880</b>	<b>42,80</b>
3000 PSI	100	3"1/2	<b>BSM3056100</b>	<b>72,82</b>
3000 PSI	114.3	4"	<b>BSM30641143</b>	<b>81,70</b>
3000 PSI	139.7	5"	<b>BSM30801397</b>	<b>100,53</b>
6000 PSI	16	1/2"	<b>BSM600816</b>	<b>10,03</b>
6000 PSI	25	3/4"	<b>BSM601225</b>	<b>12,77</b>
6000 PSI	30	1"	<b>BSM601630</b>	<b>14,43</b>
6000 PSI	38	1"1/4	<b>BSM602038</b>	<b>16,67</b>
6000 PSI	45	1"1/2	<b>BSM602445</b>	<b>21,15</b>
6000 PSI	60	2"	<b>BSM603260</b>	<b>35,00</b>

## Cono Cetop soldable exterior

Cetop welding adaptor

Collet Cetop à souder

Adattatore a saldare Cetop

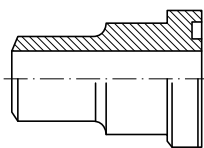

SERIE	Ø OUTER Ø EXT.	SIZE TAMAÑO	Part nº Referencia	€
3000 PSI	18	3/8"	<b>BCTS30618</b>	<b>8,23</b>
6000 PSI	18	3/8"	<b>BCTS60618</b>	<b>9,89</b>

## Bridas Cetop

Cetop flanges

Brides Cetop

Flangia Cetop

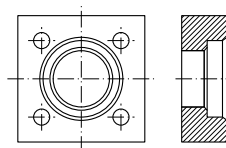

SERIE	Ø INNER Ø INT.	SIZE TAMAÑO	Part nº Referencia	€
3000 PSI	31	1/2"	<b>BCT30831</b>	<b>8,23</b>

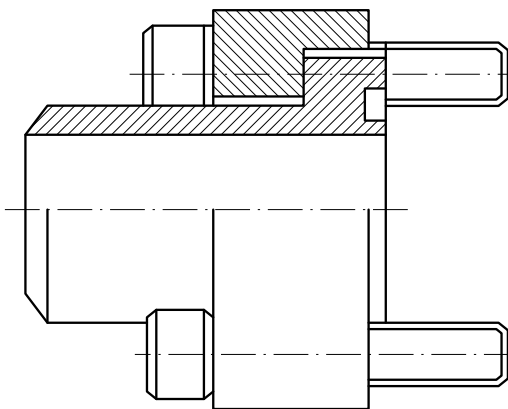
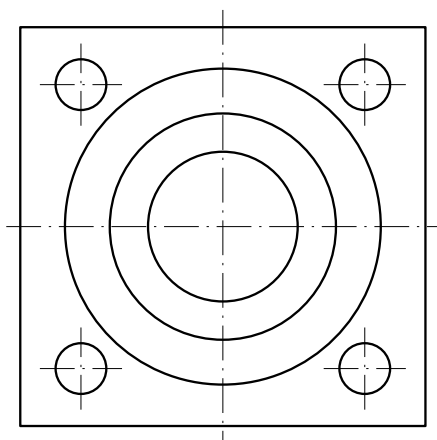



# Bridas SAE

SAE flanges  
Brides SAE  
Flangia SAE

## Características comunes

Common characteristics  
Données communes  
Caratteristiche comuni

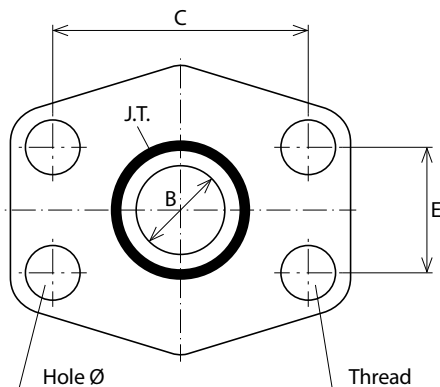

## Bridas 3000 PSI

Flanges 3000 PSI  
Brides 3000 PSI  
Flangia 3000 PSI

Tamaño Size Taille Misura	Max. pre. Max. pre. Max. pre.	B	C	E	O'ring NBR O'ring NBR O'ring NBR	Junta PU PU seal Joint PU Guarnizione in PU	Ø	Tornillo * Screw * Vis * Vite *	Rosca Thread Filetage Filetto
1/2"	345 bar	13	38,1	17,48	18,64 x 3,53	JBR08	9	TB8X30	M8
3/4"	345 bar	19	47,63	22,23	24,99 x 3,53	JBR12	11	TB10X35	M10
1"	345 bar	25	52,37	26,19	32,92 x 3,53	JBR16	11	TB10X35	M10
1 1/4"	276 bar	32	58,72	30,18	37,70 x 3,53	JBR20	11,5	TB10X40	M10
1 1/2"	207 bar	38	69,85	35,71	47,22 x 3,53	JBR24	13,5	TB12X45	M12
2"	207 bar	51	77,77	42,88	56,74 x 3,53	JBR32	13,5	TB12X45	M12
2 1/2"	172 bar	63	88,9	50,8	66,27 x 3,53		13,5	TB12X45	M12
3"	138 bar	73	106,38	61,93	85,32 x 3,53		17,5	TB16X50	M16
3 1/2"	34 bar	89	120,65	69,85	98,02 x 3,53		17,5	TB16X50	M16
4"	34 bar	99	130,18	77,77	110,72 x 3,53		17,5	TB16X50	M16

## Bridas 6000 PSI

Flanges 6000 PSI  
Brides 6000 PSI  
Flangia 6000 PSI

Tamaño Size Taille Misura	Max. pre. Max. pre. Max. pre.	B	C	E	O'ring NBR O'ring NBR O'ring NBR	Junta PU PU seal Joint PU Guarnizione PU	Ø	Tornillo * Screw * Vis * Vite *	Rosca Thread Filetage Filetto
1/2"	414 bar	13	40,49	18,24	18,64 x 3,53	JBR08	9	TB8X30	M8
3/4"	414 bar	19	50,8	23,8	24,99 x 3,53	JBR12	11	TB10X40	M10
1"	414 bar	25	57,15	27,76	32,92 x 3,53	JBR16	13	TB12X45	M12
1 1/4"	414 bar	32	66,68	31,75	37,70 x 3,53	JBR20	15	TB14X45	M14
1 1/2"	414 bar	38	79,38	36,5	47,22 x 3,53	JBR24	17	TB16X50	M16
2"	414 bar	51	98,82	44,45	56,74 x 3,53	JBR32	21	TB20X70	M20

\* Tornillos en acero carbono. Para tornillos en acero inoxidable, pedir ZTB...

Screws are in carbon steel. For Stainless Steel screws, ask for ZTB... part number.  
Les vis sont en acier carbone. Pour vis en acier inoxydable, veuillez demander les références ZTB ...  
Le viti sono in acciaio al carbonio. Per viti in acciaio inox, ordinare con codice ZTB...

## **Abrazaderas**

*Clamps*

Colliers

*Collari fissatubo*

## **Abrazaderas para tubo TrΔle**

*Clamps for pipe TrΔle*

Colliers de fixation TrΔle

*Collari fissatubo TrΔle*

6

# Abrazaderas para tubo TrΔle

Clamps for pipe TrΔle  
 Colliers de fixation TrΔle  
 Collari fissatubo TrΔle

## Abrazaderas serie ligera / Light serie clamp / Colliers de fixation série légère / Collari fissatubo serie leggera

| 237



A40AZ

AML

A41AZ

## Plásticos serie ligera / Plastics light series / Plastiques série légère / Plastica profil serie leggera

| 238



A C

AL C

## Serie ligera simple y reforzada / Light serie simple clamp / Colliers de fixation simple série légère / Collari fissatubo serie leggera singoli

| 239



APIN

AVTC

APS

AVTE

## Dobles / paralelas / Double clamp - parallel / Colliers de fixation doubles / Collari fissatubo doppi

| 240



AZCFS

ADPIN

AD C

ADPS

ADVTE

## Serie pesada / Heavy serie clamp / Colliers de fixation simple série lourde / Collari fissatubo serie pesante

| 241

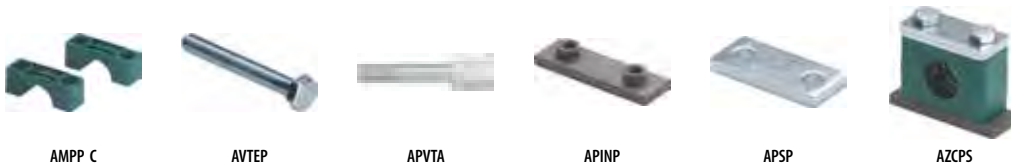

AMPP C

AVTEP

APVTA

APINP

APSP

AZCPS

## Accesorios abrazaderas / Accessories for clamps / Accessoires pour colliers / Accessori per collari fissatubo

| 242



APAG

TC/TS

ADPAG

APT

## Accesorios para apilar / Accessories for pile up / Accessoires empiler / Accessori per componibili

| 243



AVTA

ADPA

ADVTA

APA

# Abrazaderas para tubo TrΔle

Clamps for pipe TrΔle  
Colliers de fixation TrΔle  
Collari fissatubo TrΔle

Pipe

DIN 2353 Pipe Fittings

Gas tube fittings

JIC 37° fittings

SAE Flanges

Clamps

Machines for processing rigid pipes

## Abrazadera simple completa, serie ligera

Light serie simple clamp

Collier de fixation complet simple, série légère

Collari fissatubo serie leggera singoli



DN	GROUP GRUPO	UNITS PER BAG CANTIDAD / BOLSA	Part nº Referencia	€
6	1	10	A40AZ06	1,54
8	1	10	A40AZ08	1,54
10	1	10	A40AZ10	1,54
12	1	10	A40AZ12	1,54
1/4"	2	10	A40AZ13.2	1,65
14	2	10	A40AZ14	1,65
15	2	10	A40AZ15	1,65
16	2	10	A40AZ16	1,65
3/8"	2	10	A40AZ16.7	1,65
18	2	10	A40AZ18	1,65
19	3	10	A40AZ19	1,95
20	3	10	A40AZ20	1,95
1/2"	3	10	A40AZ21.3	1,95
22	3	10	A40AZ22	1,95
25	3	10	A40AZ25	1,95
3/4"	4	10	A40AZ26.7	2,25
28	4	10	A40AZ28	2,25
30	4	10	A40AZ30	2,25
32	5	10	A40AZ32	2,90
1"	5	10	A40AZ33.3	2,90
35	5	10	A40AZ35	2,90
38	5	10	A40AZ38	2,90
40	5	10	A40AZ40	2,90
42	5	10	A40AZ42	2,90
1"1/2	6	10	A40AZ48.3	3,96
50.8	6	10	A40AZ50.8	3,96

Consultar plásticos en poliamida y aluminio / Polyamide and aluminium plastics, on request /  
Plastique polyamide et aluminium, sur demande / Plastica polyamide e alluminio, su richiesta

## Abrazadera completa, serie ligera reforzada

Light serie reinforced clamp

Colliers de fixation simple série légère renforcés

Collare fissatubo rin forzato completo



DN	GROUP GRUPO	UNITS PER BAG CANTIDAD / BOLSA	Part nº Referencia	€
6	1	10	A41AZ06	1,86
8	1	10	A41AZ08	1,86
10	1	10	A41AZ10	1,86
12	1	10	A41AZ12	1,86
1/4"	2	10	A41AZ13.2	2,08
14	2	10	A41AZ14	2,08
15	2	10	A41AZ15	2,08
16	2	10	A41AZ16	2,08
3/8"	2	10	A41AZ16.7	2,08
18	2	10	A41AZ18	2,08
20	3	10	A41AZ20	2,42
1/2"	3	10	A41AZ21.3	2,42
22	3	10	A41AZ22	2,42
25	3	10	A41AZ25	2,42
3/4"	4	10	A41AZ26.7	2,79
28	4	10	A41AZ28	2,79
30	4	10	A41AZ30	2,79
1"	5	10	A41AZ33.7	3,55
35	5	10	A41AZ35	3,55
38	5	10	A41AZ38	3,55
40	5	10	A41AZ40	3,55
42	5	10	A41AZ42	3,55
44.5	6	10	A41AZ44.5	4,74
1"1/2	6	10	A41AZ48.3	4,74
50.8	6	10	A41AZ50.8	4,74

Consultar plásticos en poliamida y aluminio / Polyamide and aluminium plastics, on request /  
Plastique polyamide et aluminium, sur demande / Plastica polyamide e alluminio, su richiesta

## Plásticos para abrazaderas anti-vibración

Plastics for clamps anti-vibration

Plastiques pour colliers de fixation anti-vibratoire

Collari fissatubo anti-vibrazioni



DN	SERIE	Part nº Referencia	€
12.7	L	AML401270	6,88
14	L	AML401400	6,88
19	L	AML401900	6,88
22	L	AML602200	9,99
28	L	AML602800	9,99
30	L	AML603000	9,99
35	S	AMS403500	23,32
38	S	AMS403800	23,32

## ABRAZADERAS ANTI-VIBRACIÓN CLAMPS ANTI-VIBRATION



Colliers de fixation anti-vibratoire  
Collari fissatubo anti-vibrazioni

# Abrazaderas para tubo TrΔle

Clamps for pipe TrΔle  
Colliers de fixation TrΔle  
Collari fissatubo TrΔle

## Plásticos polipropileno, serie ligera

Plastics polypropylene simple, light series

Plastique polypropylene, série légère

Plastica polipropilene



DN	GROUP GRUPO	Part nº Referencia	€
6	1	A106C	0,63
8	1	A108C	0,63
10	1	A110C	0,63
12	1	A112C	0,63
1/4"	2	A213.2C	0,65
14	2	A214C	0,65
15	2	A215C	0,65
3/8"	2	A216.7C	0,65
16	2	A216C	0,65
18	2	A218C	0,65
19	3	A319C	0,84
20	3	A320C	0,84
1/2"	3	A321.3C	0,84
22	3	A322C	0,84
23	3	A323C	0,84
25	3	A325C	0,84
3/4"	4	A426.7C	1,02
28	4	A428C	1,02
30	4	A430C	1,02
32	5	A532C	1,54
1"	5	A533.7C	1,54
35	5	A535C	1,54
38	5	A538C	1,54
40	5	A540C	1,54
42	5	A542C	1,54
44.5	6	A644.5C	2,36
1"1/2	6	A648.3C	2,36
50.8	6	A650.8C	2,36

Precio por pareja / Price per couple / Prix par paire / Prezzo per coppia

## Plásticos perfil liso, serie ligera

Plastics smooth profile, light series

Plastique profil lisse, série légère

Plastica profil liscio



DN	GROUP GRUPO	Part nº Referencia	€
8	1	AL108C	0,63
10	1	AL110C	0,63
12	1	AL112C	0,63
1/4"	2	AL213.2C	0,65
15	2	AL215C	0,65
3/8"	2	AL216.7C	0,65
18	2	AL218C	0,65
20	3	AL320C	0,84
1/2"	3	AL321.3C	0,84
22	3	AL322C	0,84
25	3	AL325C	0,84
3/4"	4	AL426.7C	1,02
28	4	AL428C	1,02
30	4	AL430C	1,02
1"	5	AL533.3C	1,54
35	5	AL535C	1,54
38	5	AL538C	1,54
42	5	AL542C	1,54

Precio por pareja / Price per couple / Prix par paire / Prezzo per coppia

### PLÁSTICOS POLIPROPILENO PLASTICS POLYPROPYLENE



### PLASTIQUE POLYPROPYLENE PLASTICA POLIPROPILENE

### PLÁSTICOS PERFIL LISO RECOMENDADO PARA MANGUERA PLASTICS SMOOTH PROFILE RECOMMENDED FOR HOSES



### PLASTIQUE PROFIL LISSE RECOMMANDÉ POUR TOUYAUX PLASTICA PROFILO LISCIO RACCOMANDATO PER TUBO FLEX

# Abrazaderas para tubo TrΔle

Clamps for pipe TrΔle  
Colliers de fixation TrΔle  
Collari fissatubo TrΔle

Pipe

DIN 2353 Pipe Fittings

Gas tube fittings

JIC 37° fittings

SAE Flanges

Clamps

Machines for processing rigid pipes

## Chapas inferiores, serie ligera

Lower plate simple, light series

Plaques inférieures à souder série légère

Piastre inferiori



GROUP GRUPO	Part n° Referencia	€
1	APIN1	0,73
2	APIN2	0,75
3	APIN3	0,84
4	APIN4	0,93
5	APIN5	1,00
6	APIN6	1,18

## Tornillos cabeza Allen, serie ligera

Simple Allen bolt, light series

Vis tête six pans creux Allen série légère

Vite Allen



THREAD ROSCA	GROUP GRUPO	Part n° Referencia	€
M6	1	AVTC1	0,11
M6	2	AVTC2	0,14
M6	3	AVTC3	0,15
M6	4	AVTC4	0,18
M6	5	AVTC5	0,24
M6	6	AVTC6	0,24

## Chapas superiores, serie ligera reforzada

Upper plate, light serie reinforced

Plaques supérieures de protection, série légère renforcée

Piastre superiori



GROUP GRUPO	Part n° Referencia	€
1	APS1	0,34
2	APS2	0,43
3	APS3	0,48
4	APS4	0,54
5	APS5	0,64
6	APS6	0,77

## Tornillos cabeza hexagonal, serie ligera reforzada

Hexagonal bolt, light serie reinforced

Vis hexagonale, série légère renforcée

Vite esagonale



THREAD ROSCA	GROUP GRUPO	Part n° Referencia	€
M6	1	AVTE1	0,12
M6	2	AVTE2	0,13
M6	3	AVTE3	0,15
M6	4	AVTE4	0,17
M6	5	AVTE5	0,23
M6	6	AVTE6	0,26

# Abrazaderas para tubo TrΔle

Clamps for pipe TrΔle  
Colliers de fixation TrΔle  
Collari fissatubo TrΔle

## Abrazaderas dobles completas

Double clamp - parallel

Colliers de fixation doubles complets

Collare fissatubo doppio completo



DN	GROUP GRUPO	UNITS PER BAG CANTIDAD / BOLSA	Part n° Referencia	€
6	1	10	AZCFS06	1,84
8	1	10	AZCFS08	1,84
10	1	10	AZCFS10	1,84
12	1	10	AZCFS12	1,84
1/4"	2	10	AZCFS13.2	2,53
14	2	10	AZCFS14	2,53
15	2	10	AZCFS15	2,53
16	2	10	AZCFS16	2,53
3/8"	2	10	AZCFS16.7	2,53
18	2	10	AZCFS18	2,53
19	3	10	AZCFS19	3,03
20	3	10	AZCFS20	3,03
1/2"	3	10	AZCFS21.3	3,03
22	3	10	AZCFS22	3,03
25	3	10	AZCFS25	3,03
3/4"	4	10	AZCFS26.7	3,64
28	4	10	AZCFS28	3,64
30	4	10	AZCFS30	3,64
32	5	10	AZCFS32	4,81
1"	5	10	AZCFS33.3	4,81
35	5	10	AZCFS35	4,81
38	5	10	AZCFS38	4,81
40	5	10	AZCFS40	4,81
42	5	10	AZCFS42	4,81

Consultar plásticos en poliamida / Polyamide plastics, on request / Plastique polyamide, sur demande / Plastica poliamide, su richiesta

## Chapas inferiores

Lower plate double

Plaques inférieures à souder doubles

Piastre inferiori



THREAD ROSCA	GROUP GRUPO	Part n° Referencia	€
M6	1	ADPIN1	0,86
M8	2	ADPIN2	1,11
M8	3	ADPIN3	1,29
M8	4	ADPIN4	1,47
M8	5	ADPIN5	1,77

## Plásticos polipropileno dobles

Plastics polypropylene double

Plastiques polypropylene doubles

Plastica polipropilene



DN	GROUP GRUPO	Part n° Referencia	€
6	1	AD106C	0,69
8	1	AD108C	0,69
10	1	AD110C	0,69
12	1	AD112C	0,69
1/4"	2	AD213.2C	0,80
14	2	AD214C	0,80
15	2	AD215C	0,80
3/8"	2	AD216.7C	0,80
16	2	AD216C	0,80
18	2	AD218C	0,80
19	3	AD319C	0,97
20	3	AD320C	0,97
1/2"	3	AD321.3C	0,97
22	3	AD322C	0,97
25	3	AD325C	0,97
3/4"	4	AD426.7C	1,23
28	4	AD428C	1,23
30	4	AD430C	1,23
32	5	AD532C	1,91
1"	5	AD533.3C	1,91
35	5	AD535C	1,91
38	5	AD538C	1,91
40	5	AD540C	1,91
42	5	AD542C	1,91

Precio por pareja / Price per couple / Prix par paire / Prezzo per coppia

## Chapas superiores

Upper plate double

Plaques supérieures de protection doubles

Piastre superiori



GROUP GRUPO	Part n° Referencia	€
1	ADPS1	0,34
2	ADPS2	0,43
3	ADPS3	0,52
4	ADPS4	0,66
5	ADPS5	0,84

## Tornillos cabeza hexagonal

Hexagonal bolt double

Vis hexagonale

Vite esagonale



THREAD ROSCA	GROUP GRUPO	Part n° Referencia	€
M6	1	ADVTE1	0,14
M8	2	ADVTE2	0,25
M8	3	ADVTE3	0,30
M8	4	ADVTE4	0,35
M8	5	ADVTE5	0,39



# Abrazaderas para tubo TrΔle

Clamps for pipe TrΔle  
Colliers de fixation TrΔle  
Collari fissatubo TrΔle

## Plásticos polipropileno, serie pesada

Plastics polypropylene, heavy serie

Plastique polypropylene, série lourde

Plastica polipropilene



DN	GROUP GRUPO	Part nº Referencia	€
6	1	AMPP106C	1,67
8	1	AMPP108C	1,67
10	1	AMPP110C	1,67
12	1	AMPP112C	1,67
1/4"	1	AMPP113.2C	1,67
14	1	AMPP114C	1,67
15	1	AMPP115C	1,67
16	1	AMPP116C	1,67
18	1	AMPP118C	1,67
20	2	AMPP220C	1,82
1/2"	2	AMPP221.3C	1,82
22	2	AMPP222C	1,82
25	2	AMPP225C	1,82
3/4"	2	AMPP226.7C	1,82
28	2	AMPP228C	1,82
30	2	AMPP230C	1,82
30	3	AMPP330C	2,58
32	3	AMPP332C	2,58
1"	3	AMPP333.3C	2,58
35	3	AMPP335C	2,58
38	3	AMPP338C	2,58
40	3	AMPP340C	2,58
42	3	AMPP342C	2,58
38	4	AMPP438C	7,32
42	4	AMPP442C	7,32
45	4	AMPP444.5C *	7,32
45	4	AMPP445C	7,32
1"1/2	4	AMPP448.4C *	7,32
48	4	AMPP448C	7,32
50	4	AMPP450C	7,32
55	4	AMPP455C	7,32
2"	4	AMPP460.3C	7,32
65	4	AMPP465C	7,32
70	4	AMPP470C	7,32

\*Hasta fin de existencias. Precio por pareja / \*Until end of stock. Price per couple / \*Jusqu'à la fin du stock. Prix par paire / \*Fino ad esaurimento scorta. Prezzo per coppia

## Tornillos cabeza hexagonal, serie pesada

Hexagonal bolt, heavy serie

Vis hexagonale, série lourde

Vite esagonale



THREAD ROSCA	GROUP GRUPO	Part nº Referencia	€
M10	1	AVTEP1	0,54
M10	2	AVTEP2	0,67
M10	3	AVTEP3	0,74
M12	4	AVTEP4	1,41

## Tornillo para serie pesada apilable

Screw to pile up heavy serie

Vis à empiler série lourde

Vite per serie pesante impilabile



THREAD ROSCA	GROUP GRUPO	Part nº Referencia	€
M10	1	APVTA1	2,68
M10	2	APVTA2	3,18
M10	3	APVTA3	3,81
M12	4	APVTA4	7,45

## Chapas inferiores, serie pesada

Lower plate, heavy serie

Plaques inférieures à souder, série lourde

Piastre inferiori



THREAD ROSCA	GROUP GRUPO	Part nº Referencia	€
M10	1	APINP1	2,73
M10	2	APINP2	2,94
M10	3	APINP3	3,20
M12	4	APINP4	6,41

## Chapas superiores, serie pesada

Upper plate, heavy serie

Plaques supérieures de protection, série lourde

Piastre superiori



GROUP GRUPO	Part nº Referencia	€
1	APSP1	1,17
2	APSP2	1,32
3	APSP3	1,52
4	APSP4	3,72

# Abrazaderas para tubo TrΔle

Clamps for pipe TrΔle  
Colliers de fixation TrΔle  
Collari fissatubo TrΔle

## Abrazadera completa, serie pesada

Heavy clamp, heavy serie

Collier de fixation simple complet, série lourde

Collare fissatubo serie pesante completo



DN	GROUP GRUPO	Part n° Referencia	€
6	1	AZCPS06	6,64
8	1	AZCPS08	6,64
10	1	AZCPS10	6,64
12	1	AZCPS12	6,64
1/4"	1	AZCPS13.2	6,64
14	1	AZCPS14	6,64
15	1	AZCPS15	6,64
16	1	AZCPS16	6,64
3/8"	1	AZCPS16.7	7,23
18	1	AZCPS18	6,64
20	2	AZCPS20	7,42
1/2"	2	AZCPS21.3	7,42
22	2	AZCPS22	7,42
25	2	AZCPS25	7,42
3/4"	2	AZCPS26.7	7,42
28	2	AZCPS28	7,42
30	2	AZCPS30	7,42
32	3	AZCPS32	8,77
1"	3	AZCPS33.3	8,77
35	3	AZCPS35	8,77
38	3	AZCPS38	8,77
40	3	AZCPS40	8,77
42	3	AZCPS42	8,77
1"1/4	4	AZCPS42.4	20,26
45	4	AZCPS45	20,26
48	4	AZCPS48	20,26
1"1/2	4	AZCPS48.4	20,26
50	4	AZCPS50	20,26
55	4	AZCPS55	20,26
60	4	AZCPS60	20,26
2"	4	AZCPS60.3	20,26
65	4	AZCPS65	20,26
70	4	AZCPS70	20,26

Consultar plásticos en poliamida y aluminio / Polyamide and aluminium plastics, on request /  
Plastique polyamide et aluminium, sur demande / Plastica poliamide e alluminio, su richiesta

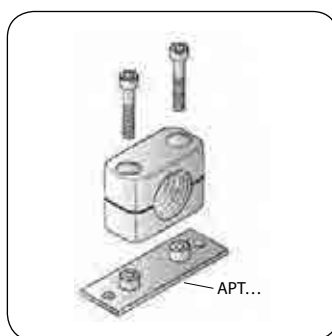
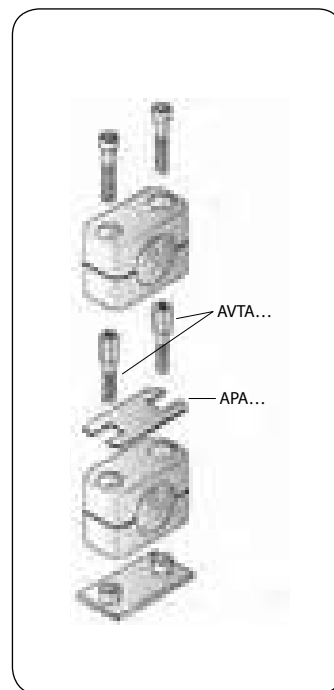
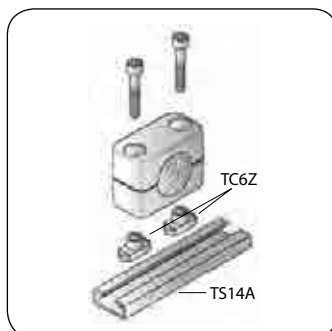
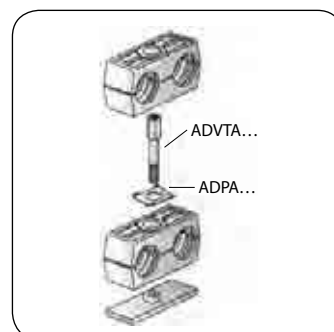
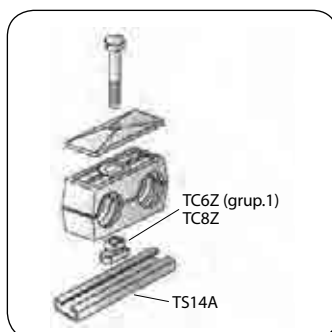
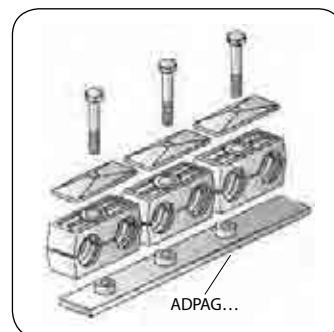
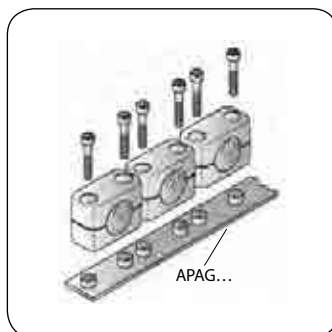

## Chapa agrupar abrazaderas simples

Jointed plate for simple clamp

Plaque à joindre pour collier simple

Piastra gruppo per collare fissatubo singolo



GROUP GRUPO	CLAMP QTY. N° ABRAZADERAS	Part n° Referencia	€
1	10	APAG1	11,78
2	10	APAG2	12,56
3	10	APAG3	12,99

# Abrazaderas para tubo TrΔle

Clamps for pipe TrΔle  
Colliers de fixation TrΔle  
Collari fissatubo TrΔle

## Accesorios carril

Accessories for lane

Accessories pour lane

Accessori per lane



THREAD ROSCA	SIZE TAMAÑO	DESCRIPTION DESCRIPCIÓN	Part n° Referencia	€
M6	--	Rail nut	TC6A	1,73
M8	--	Rail nut	TC8A	5,41
M10	--	Rail nut	TC10A	5,85
M12	--	Rail nut	TC12A	7,36
--	11x28	Mounting rail	TS11A	9,85
--	14x28	Mounting rail	TS14A	10,93
--	22x40	Mounting rail	TSP22	84,21

PVP: €/m / Price: €/m / Prix: €/m / Prezzi: €/m

## Chapa agrupar abrazaderas dobles

Jointed plate for double clamp

Plaque à joindre pour collier double

Piastra gruppo per collare fissatubo doppio



THREAD ROSCA	GROUP GRUPO	CLAMP QTY. N° ABRAZADERAS	Part n° Referencia	€
M6	1	5	ADPAG1	4,94
M8	2	2	A2DPIN2	2,71
M8	2	3	A3DPIN2	5,21
M8	2	5	ADPAG2	6,75
M8	3	3	A3DPIN3	5,21
M8	3	5	ADPAG3	7,53

## Chapa atornillar Abr. Simples

Elongated weld plate

Plaque à visser

Piastra per fissaggio



GROUP GRUPO	Part n° Referencia	€
1	APT1	0,93
2	APT2	0,95
3	APT3	1,02
4	APT4	1,09
5	APT5	1,18

## Tornillo apilar ligera

Light serie screw to pile up

Vis pour empiler série légère

Vite per piastra componibili. Serie leggera



THREAD ROSCA	GROUP GRUPO	Part n° Referencia	€
M6	1	AVTA1	2,15
M6	2	AVTA2	2,30
M6	3	AVTA3	2,52
M6	4	AVTA4	2,75
M6	5	AVTA5	3,23

## Tornillo apilar doble

Double serie screw to pile up

Vis pour empiler série double

Vite per piastra componibili. Serie doppia



THREAD ROSCA	GROUP GRUPO	Part n° Referencia	€
M8	2	ADVTA2	2,68
M8	3	ADVTA3	3,03
M8	4	ADVTA4	3,29

Para Grupo 1: AVTA1 (ligera) / For Group 1: AVTA1 (Light) / Pour le Groupe 1: AVTA1 (légère) / Per il Gruppo 1: AVTA1 (leggera)

## Chapa apilar doble

Double serie plate to pile up

Plaque pour empiler série double

Piastra componibili. Serie doppia



GROUP GRUPO	Part n° Referencia	€
1	ADPA1	0,45
2/3/4/5	ADPA2	0,45

## Chapa apilar ligera

Light serie plate to pile up

Plaque pour empiler série légère

Piastra componibili. Serie leggera



GROUP GRUPO	Part n° Referencia	€
1	APA1	0,28
2	APA2	0,35
3	APA3	0,43
4	APA4	0,50
5	APA5	0,52

## **Máquinas para procesar el tubo rígido**

*Machines for processing rigid pipes*

*Machines pour travailler le tube rigide*

*Macchine per il trattamento del tubo rigido*

7

# Maquinaria para tubo rígido

Machines for rigid tube  
Machines pour tube rigide  
Macchine per il tubo rigido

## Dobladoras Bending machine Cintreuse Curvatubi

**C-42**  
Dobladora accionamiento hidráulico  
Hydraulic bending machine



Tubo / Pipe	6 → 42 x 4 mm
Potencia / Power	2"

**CMS-42**  
Dobladora accionamiento manual hidráulico  
Manual bending machine with hydraulic operation



Tubo / Pipe	6 → 42 x 4 mm
-------------	---------------

**M18 6-18**  
Dobladora manual  
Manual bending machine



Tubo / Pipe	6 → 18 mm
-------------	-----------

**USPL 0 15 MAN**



## Radios de curvatura Bending radius Rayon de courbure Raggio di curvatura

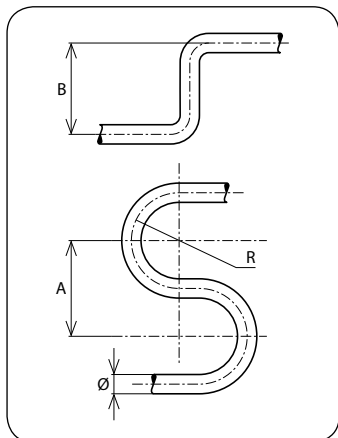

Tubo Ø Tube Ø	Radio de curvatura Bending radius	Máx. ángulo de curvatura Max. bending angle	A	B
	mm		mm	mm
6	15	170°	60	70
8	16.5	170°	60	70
10	27.5	170°	70	115
12	32.7	170°	80	120
14	46	170°	110	180
15	46	170°	110	180
16	48	170°	110	180
18	48	170°	110	190
20	66	160°	140	230
22	66	160°	140	240
25	81.5	160°	170	270
28	81	160°	180	300
30	98.5	150°	220	300
32	101	150°	220	300
35	125.5	120°	250	440
38	116	120°	250	440
42	126	120°	250	440
1/8"	27.5	170°	70	115
1/4"	46	170°	110	180
3/8"	48	170°	110	180
1/2"	66	160°	140	240
3/4"	81	160°	180	300
1"	125.5	120°	250	440
1 1/4"	126	120°	250	440

**Matrices de doblado**  
Bending tools



## Desbarbadora Deburring machine Machine à ébavurer Sbavatore

**S01**



Desbarbado exterior External deburring	6 → 42 mm
Desbarbado interior Inner deburring	6 → 42 mm
Potencia motor Engine power	0,18 KW
R.P.M.	75
R.P.M.	

**Útiles de desbarbado incluidos**  
Deburring tools included



## Otras máquinas: consultar Other machines, on request Autres machines, sur demande Altre macchine, sur richiesta



# Maquinaria para tubo rígido

Machines for rigid tube  
 Machines pour tube rigide  
 Macchine per il tubo rigido

■ **Montaje racores DIN 2353 y JIC 37°**  
 DIN 2353 and JIC 37° pipe fittings assembly  
 Montage du raccord DIN 2353 et JIC 37°  
 Assemblaggio del raccordo ad anello DIN 2353 e JIC 37°

**USFL/01 MAN**  
**Accionamiento manual hidráulico**  
 Manual device with hydraulic operation



**USFL/01**  
**Accionamiento hidráulico**  
 Hydraulic device



**Matrices JIC 37°**  
 Tools JIC 37°



**Bloque BL JIC 37°**  
 BL Block JIC 37°



**Machos y matrices DIN 2353 24°**  
 Males DIN 2353 24°



**UNISPEED 01 - US02**



**Portaherramientas opcional**  
 Tool handler optional

	US-FL/01	US-FL/01 MAN	
<b>Premontaje DIN 2353 24° / Preassembling DIN 2353 24°</b>	6 → 42 x 4 mm	6 → 42 x 4 mm	Con BL
<b>Abocardado JIC 37° / 37° JIC Flaring</b>	6 → 42 x 4 mm	6 → 42 x 4 mm	

■ **Centro de trabajo**  
 Multi-functional unit  
 Unité multifonctionnelle  
 Unità multifunzione

	Mini Mini	Completo Complete
<b>Premontaje DIN 2353 24°</b> Pre-assembling	6 → 42 x 4 mm	6 → 42 x 4 mm
<b>Abocardado JIC 27°</b> 37° Flaring	6 → 42 x 4 mm	6 → 42 x 4 mm
<b>Curvatura</b> Bending	6 → 42 x 4 mm	6 → 42 x 4 mm
<b>Desbarbado</b> Deburring	Máx. Ø 42 x 4 mm	Máx. Ø 42 x 4 mm

**Machos y matrices DIN 2353 24°**  
 Males DIN 2353 24°



**Matrices JIC 37°**  
 Tools JIC 37°



**Completo**  
 Complete



**Mini**  
 Mini



■ **Otras máquinas: consultar**  
 Other machines, on request  
 Autres machines, sur demande  
 Altre macchine, sur richiesta



<b>Tubo</b> Tube	6 → 15 mm
---------------------	-----------



Pipe

DIN 2353 Pipe Fittings

Gas tube fittings

JIC 37° fittings

SAE Flanges

Clamps

Machines for processing rigid pipes

# PLANCHAS, PAVIMENTOS Y ALFOMBRAS

SHEETING, FLOORING & MATS



PLANCHAS DE GOMA · RUBBER SHEETING

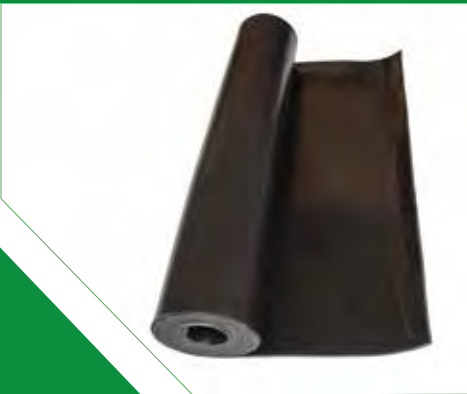

SILICONAS · SILICONE



PAVIMENTOS DE GOMA · RUBBER FLOORING



PAVIMENTOS PVC · PVC FLOORING



ALFOMBRAS · MATS

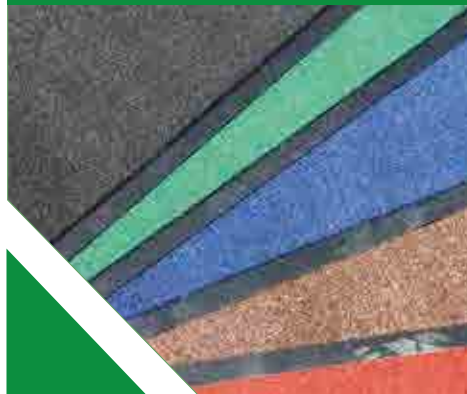

CÉSPED ARTIFICIAL · ARTIFICIAL GRASS









**Adaptadores**

*Adaptors  
Adapteurs  
Adattatori*

1

**Accesorios ORFS**

*ORFS Accessories  
Accessoires ORFS  
Accessori ORFS*

2

**Enchufes rápidos**

*Quick-release couplings  
Coupleurs rapides  
Innesti rapidi*

3

**Llaves paso, desviadores y racores giratorios**

*Ball valves, diverters and swivel fittings  
Robinets, déviateurs et raccords tournants  
Rubinetti, deviatori, raccordi girevoli*

4

**Protecciones**

*Protections  
Protections/ressorts  
Protezioni*

5

# Adaptadores

*Adaptors*

Adapteurs

*Adattatori*

## **Adaptadores BSP**

*BSP Adaptors*

Adapteurs BSP

*Adattatori BSP*

257

## **Adaptadores NPT**

*NPT Adaptors*

Adapteurs NPT

*Adattatori NPT*

272

1

# Adaptadores BSP

BSP Adaptors  
Adaptateurs BSP  
Adattatori BSP

ORFS Accessories

Quick-release couplings

Ball valves, diverters and swivel fittings

Protections

## ■ Uniones rectas macho / Straight adaptors male / Adapteur droit mâle-mâle / Adattatori diritti maschio

| 257

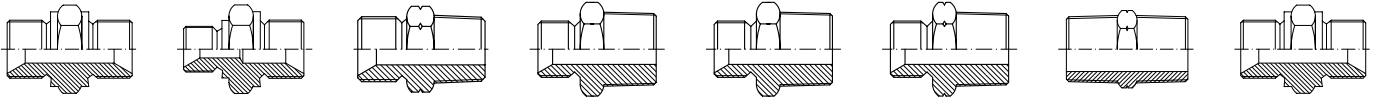

A1010

A1020

S1014

S1012

A1022

A1024

A1016

S1016

## ■ Uniones rectas macho-hembra / Adaptors male-female / Adapteur mâle-femelle / Adattatori diritti maschio-femmina

| 259

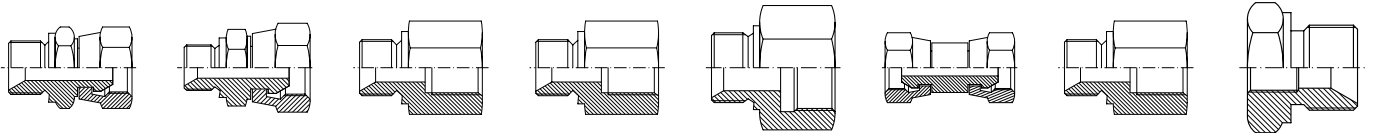

A1170

A1173

A1050

S10610

S106218

A1172

A1060

A1150

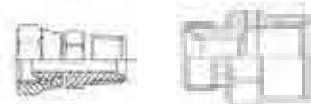

A1171

A1074

## ■ Tapones / Plugs / Bouchons adapteur / Tappi

| 261

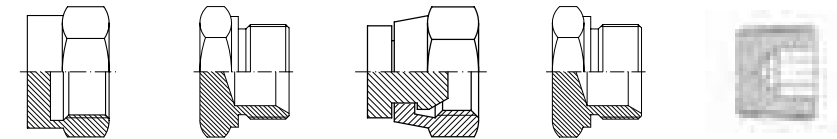

A1072

A1070

A1075

A1073

A1071

## ■ Uniones hembra y pasatabiques / Adaptors female and bulkheads / Unions femelle et passe cloison / Adattatori femmina e passaparete

| 262

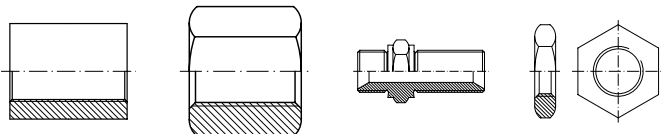

A1310

S10310

A1160

A1272

## ■ Orientables / Banjos / Adapteurs banjo / Adattatori a occhio

| 263

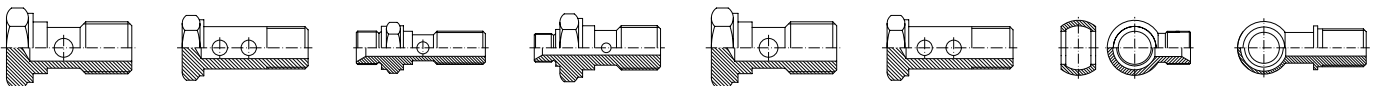

A1090

A1094

A1092

A1093

S1092

A1096

A1140

A1112

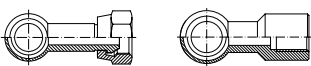

A1111

A1113

## ■ Soldables / Weldable adaptors / Adapteurs à souder / Adattatori a saldare

| 264

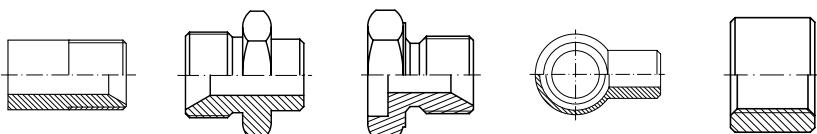

A1290

A1030

A1031

A1141

A1311

# Adaptadores BSP

BSP Adaptors  
 Adapteurs BSP  
 Adattatori BSP

■ **Codos accesoriales (tubo) / Accessorial elbows / Adapteurs coudes / Adattatori a 90° tubolari**

| 265

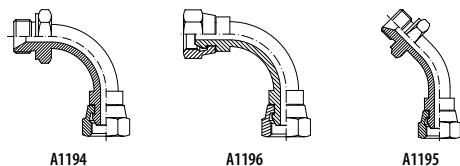

A1194

A1196

A1195

■ **Codos en forja / Forging elbows / Adapteurs coudes en forge / Adattatori a 90° forgiati**

| 266

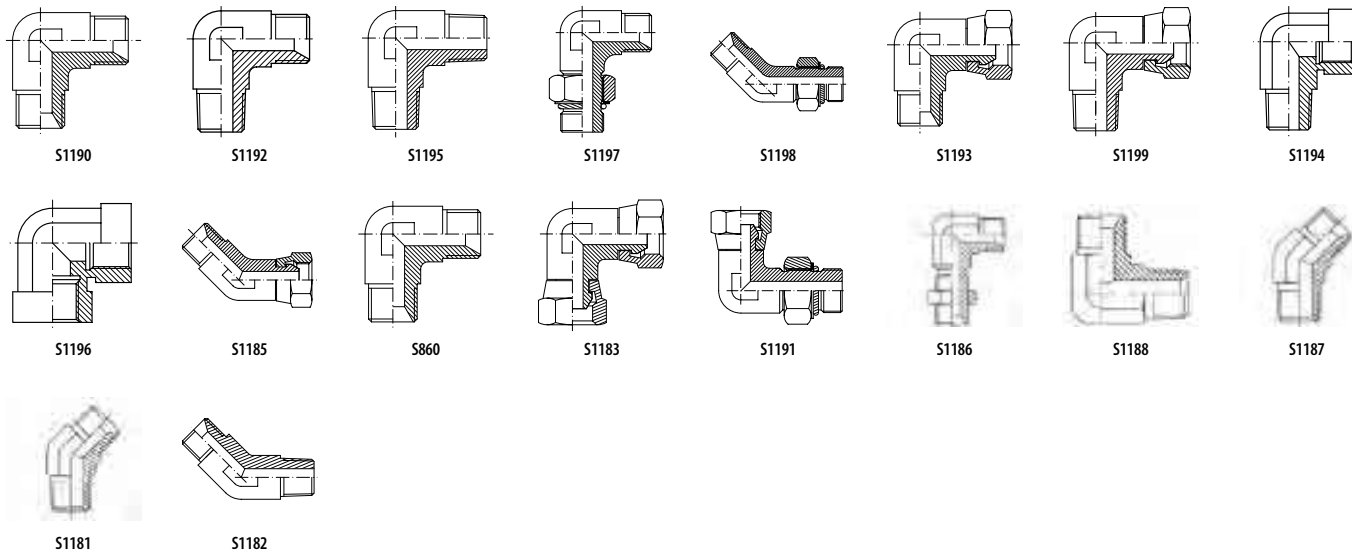

S1190

S1192

S1195

S1197

S1198

S1193

S1199

S1194

S1196

S1185

S860

S1183

S1191

S1186

S1188

S1187

S1181

S1182

■ **Te en forja / Forging Tees / Adapteurs Tés en forge / Adattatori a T forgiati**

| 268

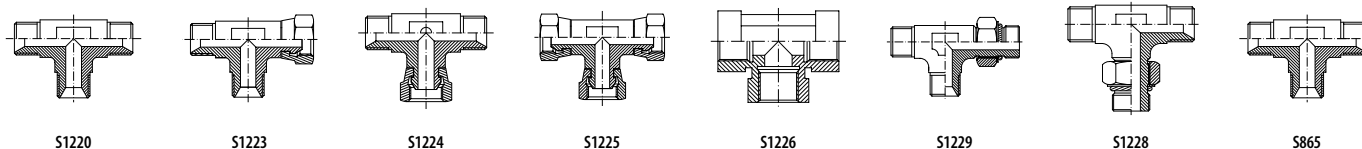

S1220

S1223

S1224

S1225

S1226

S1229

S1228

S865

■ **Codos y Te en bloque (cuadrado) / Square elbows and Tees / Adapteurs coudes et Tés en bloque / Adattatori a 90° e T da quadro senza saldatura**

| 270

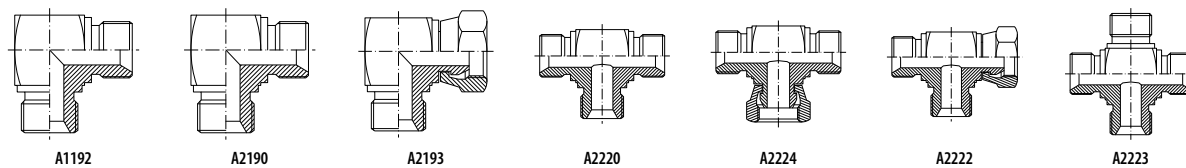

A1192

A2190

A2193

A2220

A2224

A2222

A2223

■ **Juntas metal Buna y arandelas / Bonded seals / Bague BS / Rondelle e rondelle Bonded**

| 271

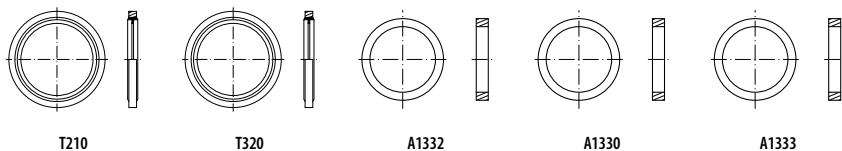

T210

T320

A1332

A1330

A1333

ORFS Accessories

Quick-release couplings

Ball valves, diverters and swivel fittings

Protections

# Adaptadores NPT

NPT Adaptors  
Adaptateurs NPT  
Adattatori NPT

## ■ Uniones rectas macho-macho / Straight adaptors male / Unions mâle / Adattatori diritti maschio - maschio

| 272

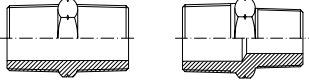

A1015

A1015

## ■ Uniones rectas macho-hembra / Adaptors male-female / Unions mâle-femelle / Adattatori diritti maschio - femmina

| 272



N1170

N1060

## ■ Tapones / Plugs / Bouchons / Tappi

| 272

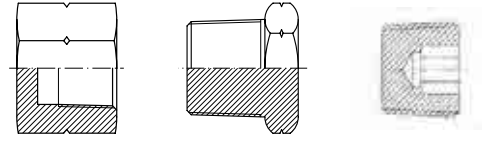

N1072

N1070

N1071

## ■ Uniones hembra y pasatabiques / Adaptors female and bulkheads / Unions femelle et passe cloison / Adattatori femmina e passaparete

| 273



N10310

## ■ Codos en forja / Forging elbows / Adapteurs coude en forge / Adattatori a 90° e 45° forgiati

| 273

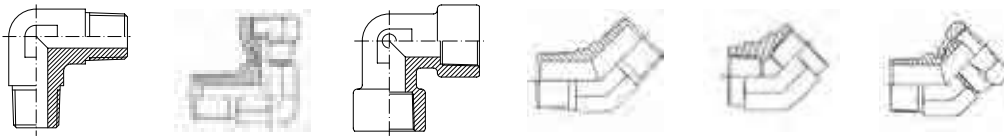

N1190

N1193

N1196

N1198

N1196

N1393

## ■ Tes en forja / Forging tees / Adapteurs Té en forge / Adattatori a T forgiati

| 274

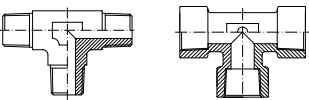

N1220

N1226



# Adaptadores BSP

BSP Adaptors  
Adapteurs BSP  
Adattatori BSP

## Adaptador macho-macho BSP (60°)

Adaptor BSP male-BSP male (60°)

Adapteur mâle BSP x mâle BSP (60°)

Niples di giunzione BSP (60°)

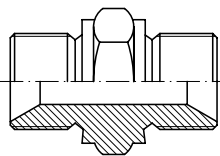

THREAD ROSCA		Part nº Referencia	€
1/8" BSP	1/8" BSP	A101002	0,56
1/4" BSP	1/4" BSP	A101004	0,70
1/4" BSP	1/4" BSP	A101004H19	0,74
3/8" BSP	3/8" BSP	A101006	0,98
1/2" BSP	1/2" BSP	A101008	1,47
5/8" BSP	5/8" BSP	A101010	2,01
3/4" BSP	3/4" BSP	A101012	2,37
1" BSP	1" BSP	A101016	4,18
1"1/4 BSP	1"1/4 BSP	A101020	7,01
1"1/2 BSP	1"1/2 BSP	A101024	11,78
2" BSP	2" BSP	A101032	21,96

## Reductor macho-macho BSP (60°)

Reducer adaptor BSP male-BSP male (60°)

Reducteur mâle BSP x mâle BSP (60°)

Niples di riduzione BSP (60°)

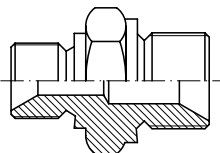

THREAD ROSCA		Part nº Referencia	€
1/8" BSP	1/4" BSP	A10200204	0,84
1/8" BSP	3/8" BSP	A10200206	0,98
1/4" BSP	3/8" BSP	A10200406	1,12
1/4" BSP	1/2" BSP	A10200408	1,40
3/8" BSP	1/2" BSP	A10200608	1,40
3/8" BSP	3/4" BSP	A10200612	2,38
1/2" BSP	3/4" BSP	A10200812	1,90
1/2" BSP	1" BSP	A10200816	4,25
5/8" BSP	1/2" BSP	A10201008	2,46
5/8" BSP	3/4" BSP	A10201012	2,60
3/4" BSP	1" BSP	A10201216	4,25
3/4" BSP	1"1/4 BSP	A10201220	7,01
1" BSP	1"1/4 BSP	A10201620	7,01
1" BSP	1"1/2 BSP	A10201624	11,37
1"1/4 BSP	1"1/2 BSP	A10202024	10,69
1"1/4 BSP	2" BSP	A10202032	20,02
1"1/2 BSP	2" BSP	A10202432	20,02

## Adaptador macho BSP (60°) - macho NPT

Adaptor BSP male (60°)-NPT male

Adapteur mâle BSP (60°) x mâle briggs (NPT)

Niples di congiunzione BSP (60°) - NPT

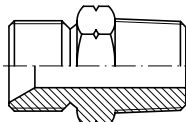

THREAD ROSCA		Part nº Referencia	€
1/8" BSP	1/8" NPT	S101402	1,38
1/4" BSP	1/4" NPT	S101404	0,95
3/8" BSP	3/8" NPT	S101406	1,40
1/2" BSP	1/2" NPT	S101408	2,12
3/4" BSP	3/4" NPT	S101412	3,51
1" BSP	1" NPT	S101416	8,08
1"1/4 BSP	1"1/4 NPT	S101420	14,38
1"1/2 BSP	1"1/2 NPT	S101424	18,12
2" BSP	2" NPT	S101432	37,61

## Adaptador macho BSP (60°) - macho BSPT

Adaptor BSP male-BSPT male (60°)

Adapteur mâle BSP (60°) x mâle gaz conique (BSPT)

Niples di congiunzione BSP (60°) - BSPT

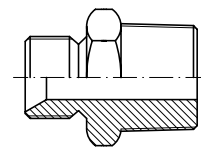

THREAD ROSCA		Part nº Referencia	€
1/8" BSP	1/8" BSPT	S101202	0,98
1/4" BSP	1/4" BSPT	S101204	0,93
3/8" BSP	3/8" BSPT	S101206	1,26
1/2" BSP	1/2" BSPT	S101208	1,63
3/4" BSP	3/4" BSPT	S101212	2,60
1" BSP	1" BSPT	S101216	4,78
1"1/4 BSP	1"1/4 BSPT	S101220	9,79
1"1/2 BSP	1"1/2 BSPT	S101224	13,27
2" BSP	2" BSPT	S101232	26,26

## Reductor macho BSP (60°) - macho BSPT

Reducer adaptor BSP male (60°)-BSPT male

Reducteur mâle BSP (60°) x mâle gaz conique (BSPT)

Niples di riduzione BSP (60°) - BSPT

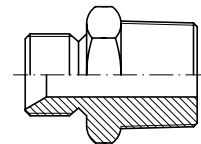

THREAD ROSCA		Part nº Referencia	€
1/4" BSP	3/8" BSPT	A10220406	2,24
3/8" BSP	1/2" BSPT	A10220608	3,23
3/8" BSP	3/4" BSPT	A10220612	4,07
1/2" BSP	1/4" BSPT	A10220804	3,48
1/2" BSP	3/4" BSPT	A10220812	5,28
3/4" BSP	1" BSPT	A10221216	7,44
1"1/4 BSP	1" BSPT	A10222016	16,01
1"1/2 BSP	1"1/4 BSPT	A10222420 *	65,46
1"1/2 BSP	2" BSPT	A10222432	50,27

\*Hasta fin de existencias. / \*Until end of stock. / \*Jusqu'à la fin du stock. / \*Fino ad esaurimento scorta.

## Reductor macho BSP (60°) - macho NPT

Reducer adaptor BSP male (60°)-NPT male

Reducteur mâle BSP (60°) x mâle briggs (NPT)

Niples di riduzione BSP (60°) - NPT

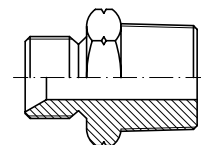

THREAD ROSCA		Part nº Referencia	€
1/4" BSP	1/8" NPT	A10240402	2,34
1/4" BSP	3/8" NPT	A10240406	2,68
1/4" BSP	1/2" NPT	A10240408	3,89
3/8" BSP	1/2" NPT	A10240608	3,89
1/2" BSP	3/8" NPT	A10240806	4,24
1/2" BSP	3/4" NPT	A10240812	6,23
3/4" BSP	1/2" NPT	A10241208	7,21
3/4" BSP	1" NPT	A10241216	11,99

# Adaptadores BSP

BSP Adaptors  
Adaptateurs BSP  
Adattatori BSP

## Adaptador macho-macho BSPT

Adaptor BPST male-BSPT male

Adaptateur mâle gaz conique (BSPT) x mâle gaz conique (BSPT)

Niples di congiunzione BSPT

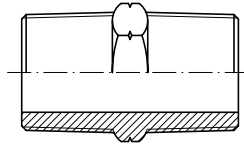

THREAD ROSCA		Part n° Referencia	€
1/4" BSPT	1/4" BSPT	<b>A10160404</b>	<b>1,70</b>
3/8" BSPT	3/8" BSPT	<b>A10160606</b>	<b>2,45</b>
1/2" BSPT	1/2" BSPT	<b>A10160808</b>	<b>3,12</b>
3/4" BSPT	3/4" BSPT	<b>A10161212</b>	<b>4,58</b>
1" BSPT	1" BSPT	<b>A10161616</b>	<b>6,71</b>

## Adaptador macho-macho Métrico (60°)

Adaptor Metric male-male (60°)

Adaptateur mâle DIN x mâle DIN Métrique (60°)

Niples di giunzione Metrico (60°)

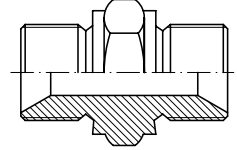

THREAD ROSCA		Part n° Referencia	€
M12x1.5	M12x1.5	<b>S101612</b>	<b>2,00</b>
M14x1.5	M14x1.5	<b>S101614</b>	<b>1,49</b>
M16x1.5	M16x1.5	<b>S101616</b>	<b>1,51</b>
M18x1.5	M18x1.5	<b>S101618</b>	<b>1,74</b>
M22x1.5	M22x1.5	<b>S101622</b>	<b>2,83</b>
M26x1.5	M26x1.5	<b>S101626</b>	<b>5,00</b>

# Adaptadores BSP

BSP Adaptors  
Adapteurs BSP  
Adattatori BSP

## Adap. macho - hembra giratoria BSP (60°)

Adaptor BSP male-BSP swivel female (60°)

Adapteur mâle BSP x femelle tournante BSP (60°)

Nipples maschio-femmina girevole BSP (60°)

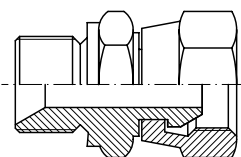

THREAD ROSCA		Part nº Referencia	€
1/8" BSP	1/8" BSP	A117002	2,32
1/4" BSP	1/4" BSP	A117004	1,85
3/8" BSP	3/8" BSP	A117006	2,04
1/2" BSP	1/2" BSP	A117008	2,72
3/4" BSP	3/4" BSP	A117012	4,41
1" BSP	1" BSP	A117016	8,27
1"1/4 BSP	1"1/4 BSP	A117020	17,76
1"1/2 BSP	1"1/2 BSP	A117024	21,82
2" BSP	2" BSP	A117032	44,03

## Reductor macho - hembra giratoria BSP (60°)

Reducer BSP male-BSP swivel female (60°)

Reducteur mâle BSP x femelle tournante BSP (60°)

Nipples di riduzione maschio-femmina girevole BSP (60°)

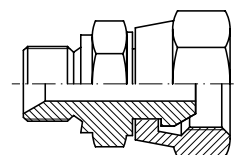

THREAD ROSCA		Part nº Referencia	€
M 1/8" BSP	F 1/4" BSP	A11730204	1,79
M 1/4" BSP	F 3/8" BSP	A11730402	2,09
M 1/4" BSP	F 3/8" BSP	A11730406	2,46
M 1/4" BSP	F 3/8" BSP	A11730604	2,59
M 1/4" BSP	F 3/8" BSP	A11730806	3,46
M 1/4" BSP	F 3/8" BSP	A11731208	5,18
M 1/4" BSP	F 3/8" BSP	A11731612	8,32
M 3/8" BSP	F 1/2" BSP	A11730608	2,90
M 1/2" BSP	F 3/4" BSP	A11730812	4,65
M 3/4" BSP	F 1" BSP	A11731216	7,56
M 3/4" BSP	F 1"1/4 BSP	A11731220	12,66
M 1" BSP	F 1"1/4 BSP	A11731620	17,51
M 1"1/4 BSP	F 1"1/2 BSP	A11732024	32,88
M 1"1/2 BSP	F 2" BSP	A11732432	52,73

## Prolongador macho (60°) - hembra fija BSP

Adaptor BSP male (60°) - BSP fixed female

Prolongateur mâle BSP (60°) x femelle gaz fixe

Prolunga maschio (60°) - femmina BSP

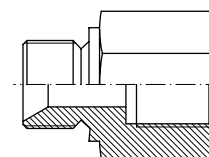

THREAD ROSCA		Part nº Referencia	€
1/8" BSP	1/8" BSP	A105002	1,04
1/8" BSP	1/8" BSP	A105002L38	1,37
1/4" BSP	1/4" BSP	A105004	1,03
1/4" BSP	1/4" BSP	A105004L46	1,80
1/4" BSP	1/4" BSP	A105004L56	1,95
3/8" BSP	3/8" BSP	A105006	1,51
3/8" BSP	3/8" BSP	A105006L44	2,02
3/8" BSP	3/8" BSP	A105006L54	2,38
1/2" BSP	1/2" BSP	A105008	2,00
1/2" BSP	1/2" BSP	A105008L50	2,31
1/2" BSP	1/2" BSP	A105008L60	2,81
3/4" BSP	3/4" BSP	A105012	2,71
3/4" BSP	3/4" BSP	A105012L72	5,48
1" BSP	1" BSP	A105016	4,39
1" BSP	1" BSP	A105016L84	8,65
1"1/4 BSP	1"1/4 BSP	A105020	10,47
1"1/4 BSP	1"1/4 BSP	A105020L92	14,42
1"1/2 BSP	1"1/2 BSP	A105024	13,25
1"1/2 BSP	1"1/2 BSP	A105024L100	21,63
2" BSP	2" BSP	A105032	20,06
2" BSP	2" BSP	A105032L100	33,89

## Reductor macho BSP (60°) - hembra fija Métrica

Reducer adaptor BSP male (60°) - Metric fixed female

Reducteur mâle BSP (60°) x femelle fixe Métrique

Nipples di riduzione maschio BSP (60°)-femmina fissa Metrica

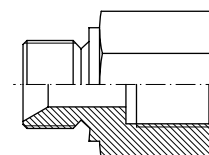

THREAD ROSCA		Part nº Referencia	€
3/8" BSP	M14x1.5	S10610614	3,52
3/8" BSP	M18x1.5	S10610618	2,95
1/2" BSP	M18x1.5	S10610818	3,51
1/2" BSP	M22x1.5	S10610822	3,51

## Reductor macho Métrico (60°) - hembra fija BSP

Reducer adaptor Metric male (60°) - BSP fixed female

Reducteur mâle Métrique (60°) x femelle fixe gaz

Nipples di riduzione maschio Metrico (60°)-femmina fissa BSP

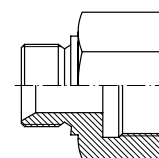

THREAD ROSCA		Part nº Referencia	€
M18x1.5	1/4" BSP	S10621804	4,89
M18x1.5	3/8" BSP	S10621806	4,89
M18x1.5	1/2" BSP	S10621808	4,03

# Adaptadores BSP

BSP Adaptors  
Adapteurs BSP  
Adattatori BSP

## Adap. hembra giratoria - hembra giratoria BSP (60°)

*Adaptor BSP swivel female - BSP swivel female (60°)*

*Adapteur femelle tournante BSP x femelle tournante BSP (60°)*

*Nipples feminas-femmina girevole BSP (60°)*

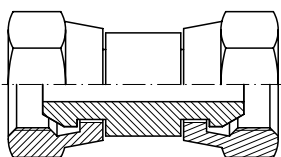

THREAD ROSCA		Part n° Referencia	€
1/4" BSP	1/4" BSP	A117204	2,53
3/8" BSP	3/8" BSP	A117206	3,28
1/2" BSP	1/2" BSP	A117208	4,97
3/4" BSP	3/4" BSP	A117212	6,57
1" BSP	1" BSP	A117216	10,69
1"1/4 BSP	1"1/4 BSP	A117220	32,98
1"1/2 BSP	1"1/2 BSP	A117224	48,25
2" BSP	2" BSP	A117232	119,51

## Reductor macho BSP (60°) - hembra fija BSP

*Reducer adaptor BPS male (60°) - BSP fixed female*

*Prolongateur reducteur mâle BSP (60°) x femelle gaz fixe*

*Prolunga di riduzione maschio (60°) - femmina BSP*

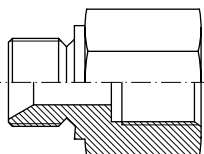

THREAD ROSCA		Part n° Referencia	€
M 1/8" BSP	F 1/4" BSP	A10600204	1,12
M 1/8" BSP	F 3/8" BSP	A10600206	1,43
M 1/4" BSP	F 1/8" BSP	A10600402	1,21
M 1/4" BSP	F 3/8" BSP	A10600406	1,51
M 1/4" BSP	F 1/2" BSP	A10600408	2,24
M 3/8" BSP	F 1/8" BSP	A10600602	2,25
M 3/8" BSP	F 1/4" BSP	A10600604	1,47
M 3/8" BSP	F 1/2" BSP	A10600608	2,00
M 3/8" BSP	F 3/4" BSP	A10600612	2,71
M 1/2" BSP	F 1/4" BSP	A10600804	2,38
M 1/2" BSP	F 3/8" BSP	A10600806	2,00
M 1/2" BSP	F 3/4" BSP	A10600812	2,29
M 1/2" BSP	F 1" BSP	A10600816	4,75
M 3/4" BSP	F 3/8" BSP	A10601206	3,08
M 3/4" BSP	F 1/2" BSP	A10601208	2,93
M 3/4" BSP	F 1" BSP	A10601216	4,31
M 3/4" BSP	F 1"1/4 BSP	A10601220	10,28
M 1" BSP	F 1/2" BSP	A10601608	4,75
M 1" BSP	F 3/4" BSP	A10601612	4,31
M 1" BSP	F 1"1/4 BSP	A10601620	10,38
M 1"1/4 BSP	F 1" BSP	A10602016	8,97
M 1"1/4 BSP	F 1" 1/2 BSP	A10602024	15,60
M 1"1/2 BSP	F 1"1/4 BSP	A10602420	22,82
M 1"1/2 BSP	F 2" BSP	A10602432	50,72

## Tapón reductor macho (60°) - hembra fija BSP

*Reducer plug BSP male (60°) - BSP fixed female*

*Bouchon reducteur mâle BSP (60°) x femelle gaz fixe*

*Tappo di riduzione maschio (60°) - femmina BSP*

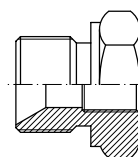

THREAD ROSCA		Part n° Referencia	€
M 1/4" BSP	F 1/8" BSP	A11500402	0,78
M 3/8" BSP	F 1/8" BSP	A11500602	1,25
M 3/8" BSP	F 1/4" BSP	A11500604	1,01
M 1/2" BSP	F 1/4" BSP	A11500804	1,63
M 1/2" BSP	F 3/8" BSP	A11500806	1,48
M 3/4" BSP	F 3/8" BSP	A11501206	2,35
M 3/4" BSP	F 1/2" BSP	A11501208	2,42
M 1" BSP	F 1/2" BSP	A11501608	4,14
M 1" BSP	F 3/4" BSP	A11501612	4,14
M 1"1/4 BSP	F 3/4" BSP	A11502012	7,26
M 1"1/4 BSP	F 1" BSP	A11502016	7,26
M 1"1/2 BSP	F 1"1/4 BSP	A11502420	9,52
M 2" BSP	F 1" 1/4 BSP	A11503220	20,69
M 2" BSP	F 1"1/2 BSP	A11503224	20,69

# Adaptadores BSP

BSP Adaptors  
Adapteurs BSP  
Adattatori BSP

## Adaptador H.G. BSP (60°) - Macho BSPT (60°)

Adaptor BSP swivel female (60°) - BSPT male (60°)

Adapteur femelle tournante BSP (60°) x mâle BSPT (60°)

Nipples femmina girevole BSP (60°)-maschio BSPT (60°)

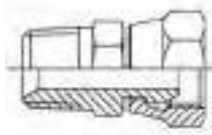

THREAD ROSCA		Part nº Referencia	€
M 1/4" BSPT	F 1/4" BSP	A11710404	3,84
M 3/8" BSPT	F 3/8" BSP	A11710606	4,59
M 1/2" BSPT	F 1/2" BSP	A11710808	5,87
M 3/4" BSPT	F 3/4" BSP	A11711212	9,18
M 1" BSPT	F 1" BSP	A11711616	14,75

## Adaptador Macho BSP (60°) - Hembra Fija NPT

Adaptor BSP male (60°) - NPT fixed female

Adapteur mâle BSP (60°) x femelle fixe NPT

Nipples di riduzione maschio (60°) - femmina NPT



THREAD ROSCA		Part nº Referencia	€
M 1/4" BSP	F 1/4" NPT	A107404	2,94
M 3/8" BSP	F 3/8" NPT	A107406	3,31
M 1/2" BSP	F 1/2" NPT	A107408	5,12
M 3/4" BSP	F 3/4" NPT	A107412	7,23
M 1" BSP	F 1" NPT	A107416	12,12

## Tapón hembra hexagonal rosca BSP

BSP fixed female plug

Bouchon femelle gaz

Tappo femmina fissa BSP

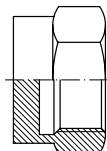

THREAD ROSCA	Part nº Referencia	€
1/8" BSP	A107202	1,21
1/4" BSP	A107204	1,21
3/8" BSP	A107206	1,50
1/2" BSP	A107208	2,06
3/4" BSP	A107212	2,70
1" BSP	A107216	3,99
1"1/4 BSP	A107220	17,41
1"1/2 BSP	A107224	26,67
2" BSP	A107232	40,32

## Tapón hembra giratoria BSP (60°)

BSP swivel female plug (60°)

Bouchon femelle tournante BSP (60°)

Tappo femmina girevole BSP (60°)

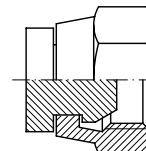

THREAD ROSCA	Part nº Referencia	€
1/4" BSP	A107504	1,11
3/8" BSP	A107506	1,43
1/2" BSP	A107508	2,05
3/4" BSP	A107512	3,10
1" BSP	A107516	4,99
1"1/4 BSP	A107520	11,57
1"1/2 BSP	A107524	16,85
2" BSP	A107532	27,87

## Tapón macho hexagonal rosca BSP (60°)

BSP hexagonal male plug (60°)

Bouchon mâle BSP (60°)

Tappo maschio esagonale BSP (60°)

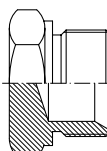

THREAD ROSCA	Part nº Referencia	€
1/8" BSP	A107002	0,59
1/4" BSP	A107004	0,71
3/8" BSP	A107006	0,92
1/2" BSP	A107008	1,33
	A107010	2,41
3/4" BSP	A107012	2,04
1" BSP	A107016	3,76
1"1/4 BSP	A107020	7,66
1"1/2 BSP	A107024	10,92
2" BSP	A107032	16,04

## Tapón macho hexagonal rosca Métrica

Metric hexagonal male plug

Bouchon mâle Métrique

Tappo maschio esagonale Metrico

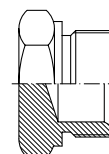

THREAD ROSCA	Part nº Referencia	€
M10x1	A10731001	0,77
M12x1.5	A10731215	1,17
M14x1.5	A10731415	0,94
M16x1.5	A10731615	1,06
M18x1.5	A10731815	1,57
M20x1.5	A10732015	1,57
M22x1.5	A10732215	1,57

## Tapón Allen BSPT sin cabeza

BSPT blanking plug

Bouchon Allen BSPT

Tappo Allen BSPT

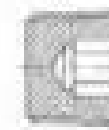

THREAD ROSCA	Part nº Referencia	€
1/4" BSPT	A107104	1,43
3/8" BSPT	A107106	2,03
1/2" BSPT	A107108	2,48
3/4" BSPT	A107112	3,09
1" BSPT	A107116	5,19

# Adaptadores BSP

BSP Adaptors  
Adaptateurs BSP  
Adattatori BSP

## Manguito roscado hembra BSP redondo

*Adaptor BSP female fixed-BSP female fixed*

*Manchon femelle gaz x femelle gaz ronde*

*Manicoto femmina - femmina BSP*

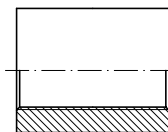

THREAD ROSCA	Part n° Referencia	€
1/8" BSP	A131002	0,88
1/4" BSP	A131004	0,97
3/8" BSP	A131006	1,32
1/2" BSP	A131008	1,85
3/4" BSP	A131012	2,82
1" BSP	A131016	5,55
1"1/4 BSP	A131020	6,43
1"1/2 BSP	A131024	9,42
2" BSP	A131032	13,20

## Manguito roscado hembra BSP hexagonal

*Hexagonal adaptor BSP fixed female-BSP fixed female*

*Manchon femelle gaz x femelle gaz hexagonal*

*Prolunga esagonale femmina-femmina BSP*

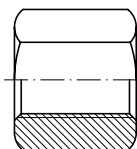

THREAD ROSCA	Part n° Referencia	€
1/4" BSP	S1031004	1,67
3/8" BSP	S1031006	2,29
1/2" BSP	S1031008	1,89
3/4" BSP	S1031012	3,43
1" BSP	S1031016	6,87
1"1/4 BSP	S1031020	17,52
1"1/2 BSP	S1031024	23,50

## Pasatabiques sin tuerca BSP cono 60°

*Straight bulkhead adaptor without nuts (60°)*

*Passe-cloison mâle BSP x mâle BSP sans équiper (60°)*

*Nipples passaparete BSP*

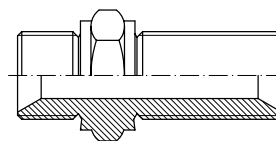

THREAD ROSCA		Part n° Referencia	€
1/4" BSP	1/4" BSP	A116004	1,71
3/8" BSP	3/8" BSP	A116006	2,12
1/2" BSP	1/2" BSP	A116008	2,94
3/4" BSP	3/4" BSP	A116012	4,49
1" BSP	1" BSP	A116016	7,75
1"1/4 BSP	1"1/4 BSP	A116020	22,44
1"1/2 BSP	1"1/2 BSP	A116024	42,17

## Tuerca pasatabiques BSP

*Counter nut for bulkhead screw-joints*

*Contre-écrou passe-cloison gaz*

*Controdado per passaparete BSP*

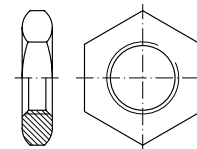

THREAD ROSCA	Part n° Referencia	€
1/4" BSP	A127204	0,44
3/8" BSP	A127206	0,62
1/2" BSP	A127208	0,92
3/4" BSP	A127212	1,32
1" BSP	A127216	2,55
1" 1/4 BSP	A127220	5,87
1" 1/2 BSP	A127224	8,74

# Adaptadores BSP

BSP Adaptors  
Adaptateurs BSP  
Adattatori BSP

## Tornillo orientable simple BSP

BSP Bolt for banjo

Vis creuse simple pour banjo filetage gaz

Bullone forato BSP

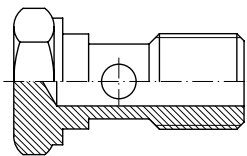

THREAD ROSCA	Part n° Referencia	€
1/8" BSP	A109002	1,11
1/4" BSP	A109004	1,11
3/8" BSP	A109006	1,38
1/2" BSP	A109008	2,13
3/4" BSP	A109012	3,95
1" BSP	A109016	7,11
1 1/4" BSP	A109020	27,97
1 1/2" BSP	A109024	72,25

## Tornillo orientable doble BSP

BSP Double bolt for banjo

Vis creuse double pour banjo filetage gaz

Bullone forato doppio BSP

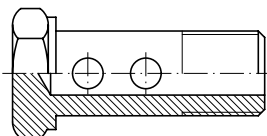

THREAD ROSCA	Part n° Referencia	€
1/4" BSP	A109404	2,12
3/8" BSP	A109406	2,77
1/2" BSP	A109408	4,44
3/4" BSP	A109412	7,47
1" BSP	A109416	15,55

## Tornillo orientable prolongado BSP

BSP Extended bolt for banjo

Vis creuse simple prolongée pour banjo

Bullone forato prolungato BSP

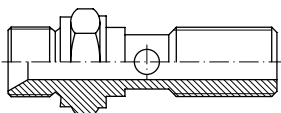

THREAD ROSCA	Part n° Referencia	€
1/4" BSP	A109204	2,56
3/8" BSP	A109206	3,26
1/2" BSP	A109208	4,44
3/4" BSP	A109212	6,35
1" BSP	A109216	12,60

## Tornillo orientable reductor BSP

BSP Reducer bolt for banjo

Vis creuse simple reduite pour banjo x mâle BSP

Bullone forato di riduzione BSP

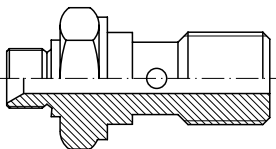

THREAD ROSCA	Part n° Referencia	€
1/4" BSP	A10930406	3,26
3/8" BSP	A10930608	4,44
1/2" BSP	A10930812	6,35
3/4" BSP	A10931216	12,60

## Tornillo orientable simple rosca Métrica

Metric bolt for banjo

Vis creuse simple pour banjo filetage Métrique

Bullone forato Metrico

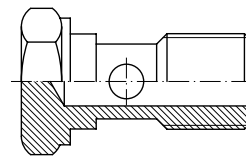

THREAD ROSCA	Part n° Referencia	€
M8x1	S109208	0,83
M10x1	S109210	0,93
M12x1.5	S109212	1,16
M14x1.5	S109214	1,20
M16x1.5	S109216	1,67
M18x1.5	S109218	1,99
M22x1.5	S109222	2,61
M26x1.5	S109226	7,23
M30x1.5	S109230	13,12

## Tornillo orientable doble rosca Métrica

Metric double bolt for banjo

Vis creuse double pour banjo filetage Métrique

Bullone forato doppio Metrico

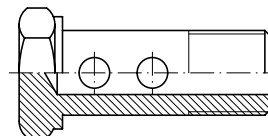

THREAD ROSCA	Part n° Referencia	€
M8x1	A10960801	2,65
M10x1	A10961001	1,68
M12x1.5	A10961215	3,13
M14x1.5	A10961415	2,48
M18x1.5	A10961815	4,25

## Esférico BSP - macho BSP (60°)

BSP Banjo-BSP male (60°)

Banjo passage gaz x mâle BSP (60°)

Adattatore ad ochhio filettato BSP

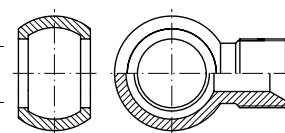

THREAD ROSCA	Ø	Part n° Referencia	€
1/8" BSP	1/8"	A114002	3,04
1/4" BSP	1/4"	A114004	1,80
3/8" BSP	3/8"	A114006	2,88
1/2" BSP	1/2"	A114008	3,41
3/4" BSP	3/4"	A114012	9,03
1" BSP	1"	A114016	31,03

## Esférico BSP con alargadera-macho BSP (60°)

BSP Banjo with extension-BSP male 60°

Banjo prolongé passage gaz x mâle BSP 60°

Adattatore ad occhio con prolunga maschio 60°

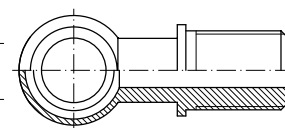

THREAD ROSCA	Ø	Part n° Referencia	€
3/8" BSP	3/8"	A111206	5,32
1/2" BSP	3/8"	A11120608	9,89
1/2" BSP	1/2"	A111208	10,76

# Adaptadores BSP

BSP Adaptors  
Adaptateurs BSP  
Adattatori BSP

## Esférico BSP con alargadera-hembra giratoria BSP

BSP Banjo with extension-BSP swivel female

Banjo prolongé passage gaz femelle tournante

Adattatore ad occhio con prolunga femmina girevole

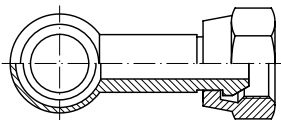

THREAD ROSCA	Ø	Part n° Referencia	€
1/2" BSP	1/2"	A111108	12,74

## Esférico BSP con alargadera-hembra fija BSP

BSP Banjo with extension-BSP fixed female

Banjo prolongé passage gaz x femelle fixe BSP

Adattatore ad occhio con prolunga femmina fissa

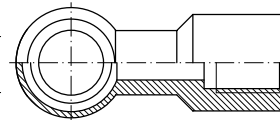

THREAD ROSCA	Ø	Part n° Referencia	€
3/8" BSP	3/8"	A111306	5,65
1/2" BSP	1/2"	A111308	11,66

## Empalme liso soldable rosca BSP (60°)

Welding union BSP male (60°)

Embout mâle lisse à souder gaz cyl BSP (60°)

Mezzo nipples tondo a saldare BSP

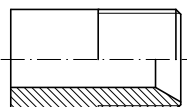

THREAD ROSCA	Part n° Referencia	€
1/8" BSP	A129002	1,20
1/4" BSP	A129004	0,70
3/8" BSP	A129006	0,84
1/2" BSP	A129008	1,06
3/4" BSP	A129012	1,85
1" BSP	A129016	4,49
1"1/4 BSP	A129020	14,31
1"1/2 BSP	A129024	15,14
2" BSP	A129032	14,48

## Racor macho BSP (60°) soldable interior

Welding adaptor BSP male (60°) (internal welding)

Mamelon BSP hexagone à souder intérieur sw (60°)

Raccordo maschio BSP a saldare di tasca

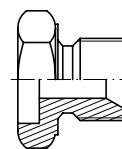

THREAD ROSCA	Part n° Referencia	€
1/8" BSP	A103102	1,38
1/4" BSP	A103104	0,90
3/8" BSP	A103106	1,06
1/2" BSP	A103108	1,88
3/4" BSP	A103112	3,17
1" BSP	A103116	5,55
1"1/4 BSP	A103120	12,49
1"1/2 BSP	A103124	16,82
2" BSP	A103132	21,95

## Racor macho BSP (60°) soldable exterior

Welding adaptor BSP male (60°) (external welding)

Mamelon BSP hexagone à souder extérieur bw (60°)

Raccordo maschio BSP a saldare

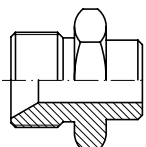

THREAD ROSCA	Part n° Referencia	€
1/8" BSP	A103002	1,38
1/4" BSP	A103004	0,95
3/8" BSP	A103006	1,24
1/2" BSP	A103008	1,62
3/4" BSP	A103012	2,67
1" BSP	A103016	4,00
1"1/4 BSP	A103020	9,33
1"1/2 BSP	A103024	11,62
2" BSP	A103032	17,81

## Esférico BSP soldable exterior

BSP Banjo external welding

Banjo passage gaz à souder extérieur (bw)

Raccordo a occhio BSP a saldare

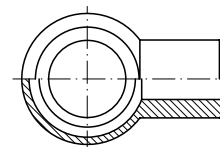

THREAD ROSCA	Ø	Part n° Referencia	€
1/8" BSP	1/8"	A114102	1,02
1/4" BSP	1/4"	A114104	1,58
3/8" BSP	3/8"	A114106	2,45
1/2" BSP	1/2"	A114108	4,08
3/4" BSP	3/4"	A114112	9,37
1" BSP	1"	A114116	27,80

## Soldables para cilindros

Welding nipples for cylinders

Raccords à souder pour verins

Borchia a saldare femmina-femmina

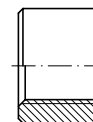

THREAD ROSCA	Part n° Referencia	€
1/4" BSP	A1311040000	0,77
3/8" BSP	A1311060000	1,00
1/2" BSP	A1311080000	1,18
3/4" BSP	A1311120000	2,54



# Adaptadores BSP

BSP Adaptors  
Adaptateurs BSP  
Adattatori BSP

## Codo 90° macho-hembra giratoria BSP (60°)

90° Elbow BSP female-male

Adapteur coude 90° mâle BSP x femelle tournante BSP (60°)

Curva 90° maschio-femmina girevole BSP 60°

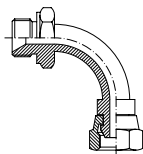

THREAD ROSCA		Part n° Referencia	€
1/4" BSP	1/4" BSP	A119404	3,05
3/8" BSP	3/8" BSP	A119406	4,22
1/2" BSP	1/2" BSP	A119408	5,23
3/4" BSP	3/4" BSP	A119412	7,78
1" BSP	1" BSP	A119416	12,21
1" 1/4 BSP	1" 1/4 BSP	A119420	19,62
1" 1/2 BSP	1" 1/2 BSP	A119424	40,92
2" BSP	2" BSP	A119432	59,59

## Codo 45° macho-hembra giratoria BSP (60°)

45° Elbow BSP female-male

Adapteur coude 45° mâle BSP x femelle tournante BSP (60°)

Curva 45° maschio-femmina girevole BSP 60°

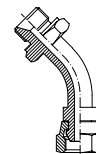

THREAD ROSCA		Part n° Referencia	€
1/4" BSP	1/4" BSP	A119504	2,98
3/8" BSP	3/8" BSP	A119506	3,49
1/2" BSP	1/2" BSP	A119508	3,63
3/4" BSP	3/4" BSP	A119512	7,49
1" BSP	1" BSP	A119516	11,56
1" 1/4 BSP	1" 1/4 BSP	A119520	19,62
1" 1/2 BSP	1" 1/2 BSP	A119524	40,92
2" BSP	2" BSP	A119532	59,59

## Codo 90° hembra giratoria-hembra giratoria BSP (60°)

90° Elbow BSP swivel female-BSP swivel female

Adapteur coude 90° femelle tournante BSP x femelle tournante BSP (60°)

Curva 90° femmina-femmina girevole BSP 60°

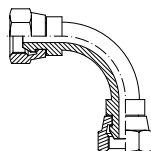

THREAD ROSCA		Part n° Referencia	€
1/4" BSP	1/4" BSP	A119604	3,63
3/8" BSP	3/8" BSP	A119606	4,00
1/2" BSP	1/2" BSP	A119608	4,72
3/4" BSP	3/4" BSP	A119612	8,36
1" BSP	1" BSP	A119616	12,79
1" 1/4 BSP	1" 1/4 BSP	A119620	21,80
1" 1/2 BSP	1" 1/2 BSP	A119624	45,06
1" 1/2 BSP	1" 1/2 BSP	A119632	69,04

# Adaptadores BSP

BSP Adaptors  
Adapteurs BSP  
Adattatori BSP

## Codo 90° macho-macho BSP (60°) forja

90° Elbow BSP male (60°)-BSP male (60°) forge

Adapteur coude 90° mâle BSP x mâle BSP (60°) forge

Adattatore a 90° maschio-maschio BSP (60°) forgiato

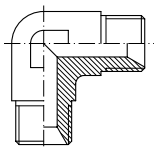

THREAD ROSCA		Part n° Referencia	€
1/8" BSP	1/8" BSP	S119002	2,71
1/4" BSP	1/4" BSP	S119004	2,53
3/8" BSP	3/8" BSP	S119006	3,01
1/2" BSP	1/2" BSP	S119008	3,70
3/4" BSP	3/4" BSP	S119012	6,02
1" BSP	1" BSP	S119016	12,28
1"1/4 BSP	1"1/4 BSP	S119020	33,61
1" 1/2 BSP	1" 1/2 BSP	S119024	42,08
2" BSP	2" BSP	S119032	106,81

## Codo 90° macho BSP (60°) -macho BSPT forja

90° Elbow BSP male (60°)-BSPT male forge

Adapteur coude 90° mâle BSP x mâle gaz conique (BSPT) (60°) forge

Adattatore a 90° maschio BSP (60°) - maschio BSPT forgiato

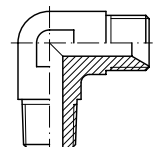

THREAD ROSCA		Part n° Referencia	€
1/8" BSP	1/8" BSPT	S119202	2,00
1/4" BSP	1/4" BSPT	S119204	2,30
3/8" BSP	3/8" BSPT	S119206	3,33
1/2" BSP	1/2" BSPT	S119208	4,28
3/4" BSP	3/4" BSPT	S119212	6,42
1" BSP	1" BSPT	S119216	15,44
1" 1/4 BSP	1" 1/4 BSPT	S119220	38,24
1" 1/2 BSP	1" 1/2 BSPT	S119224	52,46
2" BSP	2" BSPT	S119232	115,61

## Codo 90° macho-macho BSPT forja

90° Elbow BSPT male-BSPT male forge

Adapteur coude 90° mâle gaz conique (BSPT) x mâle gaz conique (BSPT) forge

Adattatore a 90° maschio-maschio BSPT forgiato

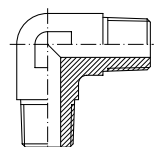

THREAD ROSCA		Part n° Referencia	€
1/4" BSPT	1/4" BSPT	S119504	4,67
3/8" BSPT	3/8" BSPT	S119506	5,55
1/2" BSPT	1/2" BSPT	S119508	5,96
3/4" BSPT	3/4" BSPT	S119512	11,18
1" BSPT	1" BSPT	S119516	21,38

## Codo 90° macho BSP (60°) -macho BSP regulable forja

90° Elbow BSP male-BSP male adjustable forge

Adapteur coude 90° mâle BSP x mâle gaz cyl orientable or + bae en forge

Adattatore a 90° maschio BSP 60° - maschio BSP regolabile forgiato

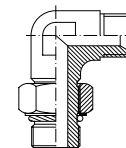

THREAD ROSCA		Part n° Referencia	€
1/8" BSP	1/8" BSP	S11970202	3,38
1/4" BSP	1/4" BSP	S11970404	3,64
3/8" BSP	1/4" BSP	S11970604	5,37
3/8" BSP	3/8" BSP	S11970606	4,83
1/2" BSP	3/8" BSP	S11970806	5,56
1/2" BSP	1/2" BSP	S11970808	6,47
3/4" BSP	1/2" BSP	S11971208	11,29
3/4" BSP	3/4" BSP	S11971212	11,25
1" BSP	3/4" BSP	S11971612	19,22
1" BSP	1" BSP	S11971616	15,13
1"1/4 BSP	1"1/4 BSP	S11972020	29,87
1" 1/2 BSP	1" 1/2 BSP	S11972424	44,64
2" BSP	2" BSP	S11973232	123,04

## Codo 45° macho BSP (60°) -macho BSP regulable forja

45° Elbow BSP male-BSP male adjustable forge

Adapteur coude 45° mâle BSP x mâle gaz cyl orientable or + bae en forge

Adattatore a 45° maschio BSP 60° - maschio BSP regolabile forgiato

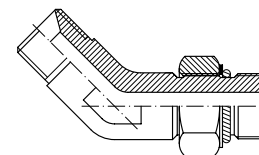

THREAD ROSCA		Part n° Referencia	€
1/8" BSP	1/8" BSP	S11980202	3,84
M 1/4" BSP	MR 1/4" BSP	S11980404	3,92
M 3/8" BSP	MR 3/8" BSP	S11980606	7,37
M 1/2" BSP	MR 1/2" BSP	S11980808	8,65
M 3/4" BSP	MR 3/4" BSP	S11981212	9,84
M 1" BSP	MR 1" BSP	S11981616	17,85
1" 1/4 BSP	1" 1/4 BSP	S11982020	32,52

## Codo 90° macho-hembra giratoria BSP (60°) forja

90° Elbow BSP male-BSP swivel female forge

Adapteur coude 90° mâle BSP x femelle tournante BSP (60°) forge

Adattatore a 90° maschio-femmina girevole BSP (60°) forgiato

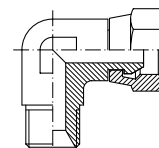

THREAD ROSCA		Part n° Referencia	€
1/8" BSP		S119302	3,69
1/4" BSP	1/4" BSP	S119304	3,64
3/8" BSP	3/8" BSP	S119306	4,99
1/2" BSP	1/2" BSP	S119308	6,26
3/4" BSP	3/4" BSP	S119312	9,27
1" BSP	1" BSP	S119316	14,49
1"1/4 BSP	1"1/4 BSP	S119320	23,31
1"1/2 BSP	1"1/2 BSP	S119324	48,63
2" BSP	2" BSP	S119332	114,56

# Adaptadores BSP

BSP Adaptors  
Adapteurs BSP  
Adattatori BSP

## Codo 90° macho BSPT-hembra giratoria BSP (60°) forja

90° Elbow BSPT male-BSP swivel female (60°) forge

Adapteur coude 90° mâle gaz conique (BSPT) x femelle tournante BSP (60°) forge

Adattatore a 90° maschio BSPT - femmina girevole BSP 60° forgiato

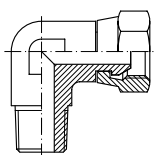

THREAD ROSCA		Part nº Referencia	€
M 1/4" BSPT	F 1/4" BSP	S119904	7,00
M 3/8" BSPT	F 3/8" BSP	S119906	8,80
M 1/2" BSPT	F 1/2" BSP	S119908	11,47
M 3/4" BSPT	F 3/4" BSP	S119912	17,20
M 1" BSPT	F 1" BSP	S119916	27,91

## Codo 90° macho BSPT-hembra fija BSP forja

90° Elbow BSPT male-BSP fixed female forge

Adapteur coude 90° mâle gaz conique (BSPT) x femelle gaz conique (BSP) forge

Adattatore a 90° maschio BSPT - femmina fissa BSP (60°) forgiato

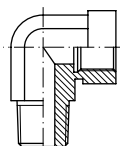

THREAD ROSCA		Part nº Referencia	€
M 1/8" BSPT	F 1/8" BSP	S119402	3,08
M 1/4" BSPT	F 1/4" BSP	S119404	4,21
M 3/8" BSPT	F 3/8" BSP	S119406	4,55
M 1/2" BSPT	F 1/2" BSP	S119408	5,56
M 3/4" BSPT	F 3/4" BSP	S119412	10,27
M 1" BSPT	F 1" BSP	S119416	14,25
M 1" 1/4 BSPT	F 1" 1/4 BSP	S119420	48,02
M 1" 1/2 BSPT	F 1" 1/2 BSP	S119424	75,72
M 2" BSPT	F 2" BSP	S119432	127,43

## Codo 90° hembra fija-hembra fija BSP forja

90° Elbow BSP fixed female-BSP fixed female forge

Adapteur coude 90° femelle fixe gaz cyl forge

Adattatore a 90° maschio BSPT - femmina fissa BSP forgiato

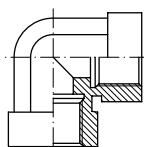

THREAD ROSCA		Part nº Referencia	€
1/8" BSP	1/8" BSP	S119602	3,28
1/4" BSP	1/4" BSP	S119604	3,88
3/8" BSP	3/8" BSP	S119606	4,83
1/2" BSP	1/2" BSP	S119608	7,52
3/4" BSP	3/4" BSP	S119612	11,33
1" BSP	1" BSP	S119616	17,03
1" 1/4 BSP	1" 1/4 BSP	S119620	50,73
1" 1/2 BSP	1" 1/2 BSP	S119624	82,64
2" BSP	2" BSP	S119632	132,10

## Codo 45° macho-hembra giratoria forja BSP 60° forja

45° Elbow BSP male-BSP swivel female forge

Adapteur coude 45° mâle-femelle tournante BSP forge

Adattatore a 45° maschio-femmina girevole BSP forgiato

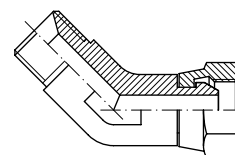

THREAD ROSCA		Part nº Referencia	€
1/8" BSP	1/8" BSP	S118502	3,91
1/4" BSP	1/4" BSP	S118504	3,55
3/8" BSP	3/8" BSP	S118506	4,28
1/2" BSP	1/2" BSP	S118508	5,92
3/4" BSP	3/4" BSP	S118512	8,93
1" BSP	1" BSP	S118516	13,75
1" 1/4 BSP	1" 1/4 BSP	S118520	25,05

## Codo 90° macho-macho Métrico (60°) forja

90° Elbow Metric adaptor male-male (60°) forge

Adapteur coude 90° mâle Métrique x mâle Métrique (60°) forge

Adattatore a 90° maschio-maschio Metrico

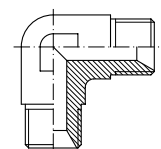

THREAD ROSCA		Part nº Referencia	€
M12x1.5	M12x1.5	S86012	5,32
M16x1.5	M16x1.5	S86016	6,56
M22x1.5	M22x1.5	S86022	13,20

## Codo 90° hembra giratoria-hembra giratoria BSP (60°) forja

90° Elbow BSP swivel female-BSP swivel female forge

Adapteur coude 90° femelle tournante BSP x femelle tournante BSP (60°) forge

Adattatore a 90° femmina girevole BSP (60°)-femmina girevole BSP (60°) forgiato

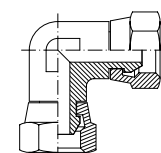

THREAD ROSCA		Part nº Referencia	€
1/8" BSP	1/8" BSP	S118302	5,50
1/4" BSP	1/4" BSP	S118304	6,10
3/8" BSP	3/8" BSP	S118306	7,98
1/2" BSP	1/2" BSP	S118308	9,11
3/4" BSP	3/4" BSP	S118312	11,29
1" BSP	1" BSP	S118316	18,06
1" 1/4 BSP	1" 1/4 BSP	S118320	36,88
1" 1/2 BSP	1" 1/2 BSP	S118324	44,86

## Codo 90° orientable macho-hembra giratoria BSP (60°) forja

90° Elbow male-swivel female - adjustable forge

Adapteur coude 90° orientable mâle-femelle tournante (60°)

Adattatore a 90° orientabile maschio-femmina girevole BSP forgiato

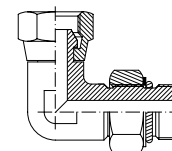

THREAD ROSCA		Part nº Referencia	€
1/4" BSP	1/4" BSP	S119104	9,21
3/8" BSP	3/8" BSP	S119106	12,36
1/2" BSP	1/2" BSP	S119108	12,85
3/4" BSP	3/4" BSP	S119112	17,91
1" BSP	1" BSP	S119116	26,48

# Adaptadores BSP

BSP Adaptors  
Adapteurs BSP  
Adattatori BSP

## Codo 90° Pasatabique Macho BSP (60°) - Macho BSP (60°)

90° Elbow bulkhead BSP adaptor male-male (60°)

Adapteur coude 90° passe cloison mâle BSP (60°) x mâle BSP (60°)

Adattatore a 90° pasaparete maschio-maschio BSP (60°)

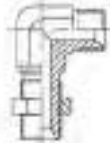

THREAD ROSCA		Part n° Referencia	€
1/4" BSP	1/4" BSP	S11860404	5,87
3/8" BSP	3/8" BSP	S11860606	7,90
1/2" BSP	1/2" BSP	S11860808	10,46
3/4" BSP	3/4" BSP	S11861212	16,94
1" BSP	1" BSP	S11861616	25,29

## Codo 90° Macho BSP (60°) - Macho NPT (60°)

90° Elbow BSP adaptor male (60°) - NPT male (60°)

Adapteur coude 90° mâle BSP (60°) x mâle NPT (60°)

Adattatore a 90° maschio BSP (60°) - maschio NPT (60°)

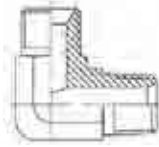

THREAD ROSCA		Part n° Referencia	€
1/4" BSP	1/4" NPT	S11880404	3,69
3/8" BSP	3/8" NPT	S11880606	5,42
1/2" BSP	1/2" NPT	S11880808	7,15
3/4" BSP	3/4" NPT	S11881212	9,94
1" BSP	1" NPT	S11881616	17,24

## Codo 45° Macho BSP (60°) - Macho BSPT (60°)

45° Elbow BSP adaptor male (60°) - BSPT male (60°)

Adapteur coude 45° mâle BSP (60°) x mâle BSPT (60°)

Adattatore a 45° maschio BSP (60°) - maschio BSPT (60°)



THREAD ROSCA		Part n° Referencia	€
1/4" BSP	1/4" BSPT	S11870404	4,44
3/8" BSP	3/8" BSPT	S11870606	5,95
1/2" BSP	1/2" BSPT	S11870808	7,98
3/4" BSP	3/4" BSPT	S11871212	10,16
1" BSP	1" BSPT	S11871616	17,76

## Te macho-macho-macho BSP forja

Tee BSP Male (60°) forge

Adapteur Té mâle BSP-mâle BSP-mâle BSP (60°) forge

Adattatore a T maschio BSP (60°) forgiato

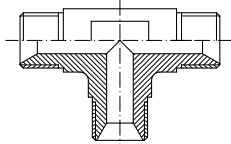

THREAD ROSCA			Part n° Referencia	€
1/8" BSP	1/8" BSP	1/8" BSP	S122002	3,31
1/4" BSP	1/4" BSP	1/4" BSP	S122004	3,17
3/8" BSP	3/8" BSP	3/8" BSP	S122006	4,20
1/2" BSP	1/2" BSP	1/2" BSP	S122008	5,94
3/4" BSP	3/4" BSP	3/4" BSP	S122012	7,68
1" BSP	1" BSP	1" BSP	S122016	14,10
1"1/4" BSP	1"1/4" BSP	1"1/4" BSP	S122020	42,08
1"1/2" BSP	1"1/2" BSP	1"1/2" BSP	S122024	67,37
2" BSP	2" BSP	2" BSP	S122032	151,51

## Codo 45° Macho BSP (60°) - Macho NPT (60°)

45° Elbow BSP adaptor male (60°) - NPT male (60°)

Adapteur coude 45° mâle BSP (60°) x mâle NPT (60°)

Adattatore a 45° maschio BSP (60°) - maschio NPT (60°)

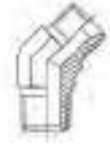

THREAD ROSCA		Part n° Referencia	€
1/4" BSP	1/4" NPT	S11810404	3,69
3/8" BSP	3/8" NPT	S11810606	5,42
1/2" BSP	1/2" NPT	S11810808	7,15
3/4" BSP	3/4" NPT	S11811212	10,39
1" BSP	1" NPT	S11811616	17,84

## Codo 45° Regulable Macho BSP - H.G. BSP (60°)

45° Adjustable BSP elbow adaptor male (60°) - BSP female (60°)

Adapteur coude 45° réglable mâle BSP (60°) x femelle tournante BSP (60°)

Adattatore a 45° orientabile maschio BSP (60°) - femmina girevole BSP (60°)

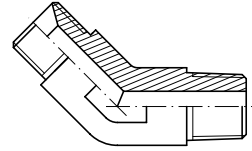

THREAD ROSCA		Part n° Referencia	€
1/4" BSP	1/4" BSP	S11820404	6,70
3/8" BSP	3/8" BSP	S11820606	10,69
1/2" BSP	1/2" BSP	S11820808	13,47
3/4" BSP	3/4" BSP	S11821212	17,69
1" BSP	1" BSP	S11821616	29,13

## Te macho-macho-hembra giratoria BSP (60°) forja

Tee BSP Male-male-swivel female (60°) forge

Adapteur Té mâle BSP-mâle BSP-femelle tournante BSP (60°) forge

Adattatore a T maschio-maschio-femmine girevole BSP forgiato

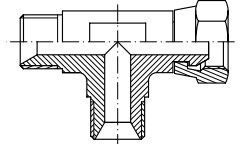

THREAD ROSCA			Part n° Referencia	€
1/8" BSP	1/8" BSP	1/8" BSP	S122302	4,22
1/4" BSP	1/4" BSP	1/4" BSP	S122304	3,75
3/8" BSP	3/8" BSP	3/8" BSP	S122306	4,82
1/2" BSP	1/2" BSP	1/2" BSP	S122308	7,13
3/4" BSP	3/4" BSP	3/4" BSP	S122312	12,09
1" BSP	1" BSP	1" BSP	S122316	17,98
1"1/4" BSP	1"1/4" BSP	1"1/4" BSP	S122320	27,60
1"1/2" BSP	1"1/2" BSP	1"1/2" BSP	S122324	80,24
2" BSP	2" BSP	2" BSP	S122332	180,27

# Adaptadores BSP

BSP Adaptors  
Adaptateurs BSP  
Adattatori BSP

## Te macho-hembra giratoria-macho BSP (60°) forja

*Tee BSP Male-swivel female-male (60°) forge*

Adaptateur Té mâle BSP-femelle tournante BSP-mâle BSP (60°) forge

Adattatore a T maschio-femmina girevole-maschio BSP forgiato

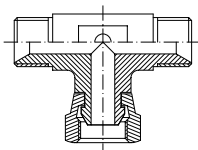

THREAD ROSCA			Part nº Referencia	€
1/8" BSP	1/8" BSP	1/8" BSP	S122402	4,03
1/4" BSP	1/4" BSP	1/4" BSP	S122404	3,88
3/8" BSP	3/8" BSP	3/8" BSP	S122406	4,99
1/2" BSP	1/2" BSP	1/2" BSP	S122408	7,13
3/4" BSP	3/4" BSP	3/4" BSP	S122412	11,56
1" BSP	1" BSP	1" BSP	S122416	17,98
1"1/4 BSP	1"1/4 BSP	1"1/4 BSP	S122420	28,78
1" 1/2 BSP	1" 1/2 BSP	1" 1/2 BSP	S122424	80,24
2" BSP	2" BSP	2" BSP	S122432	180,27

## Te hembras giratorias BSP (60°) forja

*Tee BSP Swivel female (60°) forge*

Adaptateur Té femelle tournante BSP (60°) forge

Adattatore a T femmina girevole BSP forgiato

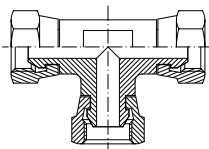

THREAD ROSCA			Part nº Referencia	€
1/8" BSP	1/8" BSP	1/8" BSP	S122502	8,35
1/4" BSP	1/4" BSP	1/4" BSP	S122504	7,65
3/8" BSP	3/8" BSP	3/8" BSP	S122506	9,02
1/2" BSP	1/2" BSP	1/2" BSP	S122508	10,47
3/4" BSP	3/4" BSP	3/4" BSP	S122512	18,40
1" BSP	1" BSP	1" BSP	S122516	30,15
1" 1/4 BSP	1" 1/4 BSP	1" 1/4 BSP	S122520	65,86

## Te hembras fijas BSP forja

*Tee BSP fixed female forge*

Adaptateur Té femelle fixe gaz (BSP) forge

Adattatore a T femmina fissa BSP

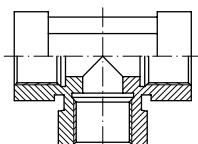

THREAD ROSCA			Part nº Referencia	€
1/8" BSP	1/8" BSP	1/8" BSP	S122602	4,01
1/4" BSP	1/4" BSP	1/4" BSP	S122604	4,83
3/8" BSP	3/8" BSP	3/8" BSP	S122606	6,57
1/2" BSP	1/2" BSP	1/2" BSP	S122608	7,92
3/4" BSP	3/4" BSP	3/4" BSP	S122612	14,16
1" BSP	1" BSP	1" BSP	S122616	25,03
1"1/4 BSP	1"1/4 BSP	1"1/4 BSP	S122620	84,06
1" 1/2 BSP	1" 1/2 BSP	1" 1/2 BSP	S122624	126,30
2" BSP	2" BSP	2" BSP	S122632	229,19

## Te macho-macho-macho regulable BSP forja

*Tee BSP male-male-male adjustable forge*

Adaptateur Té égal mâle (60°)-mâle (60°)-mâle orientable BSP forge

Adattatore a T maschio-maschio-maschio orientabile BSP

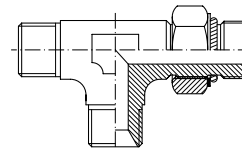

THREAD ROSCA			Part nº Referencia	€
1/4" BSP	1/4" BSP	1/4" BSP	S12290404	5,38
3/8" BSP	3/8" BSP	3/8" BSP	S12290606	7,98
1/2" BSP	3/8" BSP	1/2" BSP	S12290806	14,00
1/2" BSP	1/2" BSP	1/2" BSP	S12290808	14,98
3/4" BSP	1/2" BSP	3/4" BSP	S12291208	21,90
3/4" BSP	3/4" BSP	3/4" BSP	S12291212	32,37
1" BSP	3/4" BSP	1" BSP	S12291612	36,73
1" BSP	1" BSP	1" BSP	S12291616	51,99
1"1/4 BSP	1"1/4 BSP	1"1/4 BSP	S12292020	48,17

## Te macho-macho regulable-macho BSP forja

*Tee BSP male-male adjustable-male forge*

Adaptateur Té égal mâle (60°)-mâle orientable-mâle (60°) BSP forge

Adattatore a T maschio-maschio orientabile-maschio forgiato

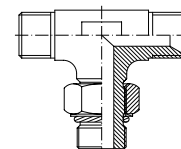

THREAD ROSCA			Part nº Referencia	€
1/4" BSP	1/4" BSP	1/4" BSP	S12280404	4,95
3/8" BSP	1/4" BSP	3/8" BSP	S12280604	10,69
3/8" BSP	3/8" BSP	3/8" BSP	S12280606	11,22
1/2" BSP	3/8" BSP	1/2" BSP	S12280806	14,00
1/2" BSP	1/2" BSP	1/2" BSP	S12280808	14,98
3/4" BSP	3/4" BSP	1/2" BSP	S12281208	21,90
3/4" BSP	3/4" BSP	3/4" BSP	S12281212	22,43
1" BSP	3/4" BSP	1" BSP	S12281612	42,75
1" BSP	1" BSP	1" BSP	S12281616	45,32
1"1/4 BSP	1" BSP	1"1/4 BSP	S12282016	48,17
1"1/4 BSP	1"1/4 BSP	1"1/4 BSP	S12282020	53,59

## Te macho-macho-macho Métrica (60°)

*Tee Metric male (60°)*

Adaptateur Té égal mâle-mâle-mâle Métrique (60°)

Adattatore a T maschio-maschio-maschio Metrico

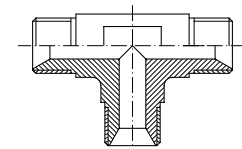

THREAD ROSCA			Part nº Referencia	€
M16x1.5	M16x1.5	M16x1.5	S86516	9,29
M18x1.5	M18x1.5	M18x1.5	S86518	10,04
M20x1.5	M20x1.5	M20x1.5	S86520	12,14
M22x1.5	M22x1.5	M22x1.5	S86522	12,14
M26x1.5	M26x1.5	M26x1.5	S86526	19,82
M30x1.5	M30x1.5	M30x1.5	S86530	26,30

# Adaptadores BSP

BSP Adaptors  
Adapteurs BSP  
Adattatori BSP

## Codo cuadrado 90° reductor macho-macho BSP (60°)

90° reducer elbow male-bsp male (60°) (square)

Adapteur carré coude 90° reducteur mâle BSP - mâle BSP (60°) en bloque

Adattatore a 90° maschio-maschio quadrato BSP (60°)

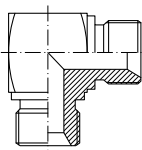

THREAD ROSCA		Part n° Referencia	€
1/8" BSP	1/4" BSP	A11920204	5,07
1/4" BSP	3/8" BSP	A11920406	6,25
3/8" BSP	1/2" BSP	A11920608	9,18
1/2" BSP	3/4" BSP	A11920812	12,55
3/4" BSP	1" BSP	A11921216	29,40

## Codo cuadrado 90° macho BSP

90° Elbow BSP male (square)

Adapteur carré Coude 90° mâle BSP

Adattatore a 90° maschio-maschio quadrato BSP (60°)

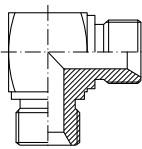

THREAD ROSCA		Part n° Referencia	€
1/4" BSP	1/4" BSP	A21900400	3,25
3/8" BSP	3/8" BSP	A21900600	3,72
1/2" BSP	1/2" BSP	A21900800	5,39
3/4" BSP	3/4" BSP	A21901200	8,00
1" BSP	1" BSP	A21901600	15,48

## Codo cuadrado 90° macho-hembra giratoria

90° Elbow BSP male-BSP swivel female (square)

Adapteur carré Coude 90° mâle BSP - femelle BSP

Adattatore a 90° maschio-femmina girevole quadrato BSP (60°)

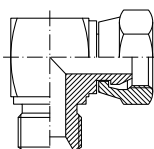

THREAD ROSCA		Part n° Referencia	€
1/4" BSP	1/4" BSP	A21930400	4,44
3/8" BSP	3/8" BSP	A21930600	4,52
1/2" BSP	1/2" BSP	A21930800	7,52
3/4" BSP	3/4" BSP	A21931200	9,11
1" BSP	1" BSP	A21931600	30,15

## Te cuadrado macho-macho-macho

Tee BSP male (square)

Adapteur carré Té mâle BSP-mâle BSP-mâle BSP

Adattatore a T maschio quadrato BSP 60°

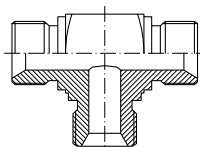

THREAD ROSCA			Part n° Referencia	€
1/4" BSP	1/4" BSP	1/4" BSP	A22200400	4,21
3/8" BSP	3/8" BSP	3/8" BSP	A22200600	5,28
1/2" BSP	1/2" BSP	1/2" BSP	A22200800	7,60
3/4" BSP	3/4" BSP	3/4" BSP	A22201200	10,93
1" BSP	1" BSP	1" BSP	A22201600	24,04

## Te cuadrado macho-hembra giratoria-macho

Tee BSP male-swivel female-male (square)

Adapteur carré Té mâle BSP-femelle tournante BSP-mâle BSP

Adattatore a T maschio-femmina girevole-maschio quadrato BSP (60°)

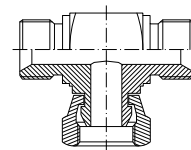

THREAD ROSCA			Part n° Referencia	€
1/4" BSP	1/4" BSP	1/4" BSP	A22240400	4,55
3/8" BSP	3/8" BSP	3/8" BSP	A22240600	6,02
1/2" BSP	1/2" BSP	1/2" BSP	A22240800	8,47
3/4" BSP	3/4" BSP	3/4" BSP	A22241200	11,64
1" BSP	1" BSP	1" BSP	A22241600	22,31

## Te cuadrado macho-macho-hembra giratoria

Tee BSP male-male-swivel female (square)

Adapteur carré Té mâle BSP-mâle BSP-femelle tournante BSP

Adattatore a T maschio-maschio-femmina girevole quadrato BSP

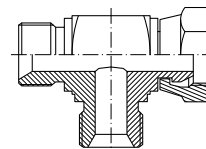

THREAD ROSCA			Part n° Referencia	€
1/4" BSP	1/4" BSP	1/4" BSP	A22220400	4,36
3/8" BSP	3/8" BSP	3/8" BSP	A22220600	5,94
1/2" BSP	1/2" BSP	1/2" BSP	A22220800	8,32
3/4" BSP	3/4" BSP	3/4" BSP	A22221200	17,90
1" BSP	1" BSP	1" BSP	A22221600	22,31

## Cruz cuadrada macho BSP

Cross BSP male (square)

Adapteur carré Croix égale mâle BSP

Croce maschio BSP 60°

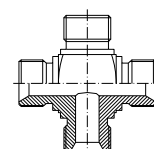

THREAD ROSCA	Part n° Referencia	€
1/4" BSP	A22230400	6,30
3/8" BSP	A22230600	5,81
1/2" BSP	A22230800	11,20
3/4" BSP	A22231200	20,13
1" BSP	A22231600	20,79

# Adaptadores BSP

BSP Adaptors  
Adaptateurs BSP  
Adattatori BSP

## Juntas Metal Buna GAS Autocentrantes

BSP Bonded Seal

Bague BS Gaz

Rondelle Bonded GAS

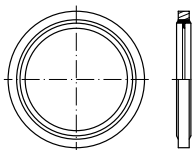

THREAD ROSCA	Part n° Referencia	€
1/8" BSP	T21002	0,17
1/4" BSP	T21004	0,18
3/8" BSP	T21006	0,23
1/2" BSP	T21008	0,25
5/8" BSP	T21010	0,54
3/4" BSP	T21012	0,36
1" BSP	T21016	0,61
1" 1/4 BSP	T21020	0,92
1" 1/2 BSP	T21024	1,13
2" BSP	T21032	1,70

Se venden en bolsas, consultar cantidades / Sold in bags, ask for quantity / Vendu dans des sacs, demandez la quantité / Venduti in sacchetti, chiedere per la quantità

## Juntas Metal Buna Métricas Autocentrantes

Metric Bonded Seal

Bague BS Métrique

Rondelle Bonded Metriche

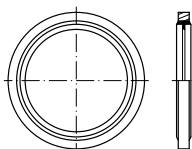

THREAD ROSCA	Part n° Referencia	€
M8x1	T32008	0,22
M10x1	T32010	0,22
M12x1.5	T32012	0,23
M14x1.5	T32014	0,25
M16x1.5	T32016	0,27
M18x1.5	T32018	0,30
M20x1.5	T32020	0,31
M22x1.5	T32022	0,34
M24x1.5	T32024	0,39
M26x1.5	T32026	0,57
M30x2	T32030	0,63
M32x2	T32032	0,89
M36x2	T32036	1,17
M42x2	T32042	2,42

Se venden en bolsas, consultar cantidades / Sold in bags, ask for quantity / Vendu dans des sacs, demandez la quantité / Venduti in sacchetti, chiedere per la quantità

## Arandelas Aluminio GAS

BSP Aluminium Collar Plate

Rondelle Gaz Aluminium

Rondella in Alluminio GAS

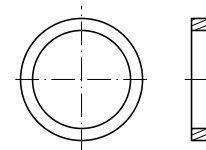

THREAD ROSCA	Ø OUTER Ø EXT.	Ø INNER Ø INT.	Part n° Referencia	€
1/8"	14	10	A133202	0,10
1/4"	19	13	A133204	0,12
3/8"	22	17	A133206	0,16
1/2"	27	21	A133208	0,25
3/4"	33	27	A133212	0,33
1"	41	33	A133216	0,48
1" 1/4	50	42	A133220	1,18
1" 1/2	60	48	A133224	0,89

## Arandelas plana Cobre recocido GAS

Annealed Copper flat Plate

Rondelle plane Gaz Cuivre recuit

Rondella in Rame

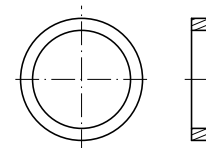

THREAD ROSCA	Ø OUTER Ø EXT.	Ø INNER Ø INT.	Part n° Referencia	€
1/8"	14	10	A133002	0,19
1/4"	19	13	A133004	0,29
3/8"	22	17	A133006	0,31
1/2"	27	21	A133008	0,47
3/4"	33	27	A133012	0,88
1"	41	33	A133016	1,00
1" 1/4	50	42	A133020	1,37
1" 1/2	60	48	A133024	2,68
2"	72	60	A133032	3,75

## Arandelas plana Acero

Steel flat Plate

Bague plate Acier

Rondelle in Acciaio

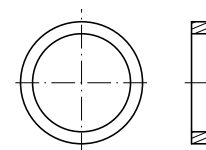

THREAD ROSCA	Part n° Referencia	€
1/8	A13330200000	0,78
1/4	A13330400000	0,51
3/8	A13330600000	0,57
1/2	A13330800000	0,97
3/4	A13331200000	1,13
1	A13331600000	1,25
1" 1/4	A13332000000	1,59

# Adaptadores NPT

NPT Adaptors  
Adaptateurs NPT  
Adattatori NPT

## Adaptor macho - macho NPT

Adaptor male NPT - male NPT

Adaptateur mâle NPT - mâle NPT

Nipples di congiunzione NPT

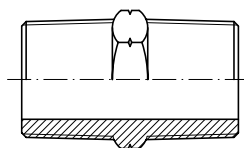

THREAD ROSCA		Part n° Referencia	€
1/8" NPT	1/8" NPT	A10150202	0,96
1/4" NPT	1/4" NPT	A10150404	0,96
3/8" NPT	3/8" NPT	A10150606	1,63
1/2" NPT	1/2" NPT	A10150808	1,92
3/4" NPT	3/4" NPT	A10151212	4,07
1" NPT	1" NPT	A10151616	6,43
1" 1/4 NPT	1" 1/4 NPT	A10152020	10,79
1 1/2" NPT	1 1/2" NPT	A10152424	14,39
2" NPT	2" NPT	A10153232	32,07

## Reductor macho - macho NPT

Reducer male NPT - male NPT

Réducteur mâle NPT - mâle NPT

Nipples di riduzione maschio - maschio NPT

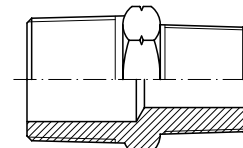

THREAD ROSCA		Part n° Referencia	€
1/4" NPT	1/8" NPT	A10150402	0,96
3/8" NPT	1/8" NPT	A10150602	1,05
3/8" NPT	1/4" NPT	A10150604	1,63
1/2" NPT	1/4" NPT	A10150804	1,92
1/2" NPT	3/8" NPT	A10150806	1,92
3/4" NPT	1/4" NPT	A10151204	3,16
3/4" NPT	3/8" NPT	A10151206	3,16
3/4" NPT	1/2" NPT	A10151208	3,16
1" NPT	1/2" NPT	A10151608	5,97
1" NPT	3/4" NPT	A10151612	5,97
1" 1/4 NPT	1" NPT	A10152016	10,79
1" 1/2 NPT	1" 1/4 NPT	A10152420	14,39
2" NPT	1" 1/2" NPT	A10153224	32,07

## Adaptador Macho NPT (60°) - H.G. NPSM (60°)

Adaptor male NPT (60°) - swivel female NPSM (60°)

Adaptateur mâle NPT (60°) - femelle tournante NPSM (60°)

Nipples di congiunzione maschio NPT (60°) - femmina girevole NPSM (60°)

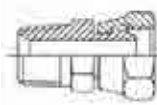

THREAD ROSCA		Part n° Referencia	€
M 1/4" NPT	F 1/4" NPSM	N11700404	3,46
M 3/8" NPT	F 3/8" NPSM	N11700606	4,44
M 1/2" NPT	F 1/2" NPSM	N11700808	5,87
M 3/4" NPT	F 3/4" NPSM	N11701212	9,18
M 1" NPT	F 1" NPSM	N11701616	13,77

## Adaptador Macho NPT (60°) - Hembra Fija NPT

Adaptor male NPT (60°) - fixed female NPT

Adaptateur mâle NPT (60°) - femelle fixe NPT

Nipples di congiunzione maschio NPT (60°) - femmina fissa NPT

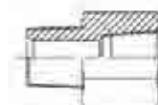

THREAD ROSCA		Part n° Referencia	€
M 1/4" NPT	F 1/4" NPT	N10600404	2,86
M 1/4" NPT	F 3/8" NPT	N10600406	3,39
M 3/8" NPT	F 1/4" NPT	N10600604	2,94
M 3/8" NPT	F 3/8" NPT	N10600606	3,46
M 3/8" NPT	F 1/2" NPT	N10600608	5,49
M 1/2" NPT	F 3/8" NPT	N10600806	4,14
M 1/2" NPT	F 1/2" NPT	N10600808	5,65
M 1/2" NPT	F 3/4" NPT	N10600812	7,75
M 3/4" NPT	F 3/4" NPT	N10601212	8,05
M 1" NPT	F 1" NPT	N10601616	12,57

## Tapón HF NPT

NPT fixed female plug

Bouchon femelle fixe NPT

Tappo femmina fissa NPT

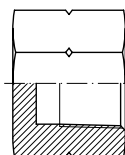

THREAD ROSCA	Part n° Referencia	€
1/8" NPT	N107202	0,70
1/4" NPT	N107204	0,88
3/8" NPT	N107206	1,36
1/2" NPT	N107208	1,93
3/4" NPT	N107212	2,81
1" NPT	N107216	4,48

## Tapón macho NPT

NPT male plug

Bouchon mâle NPT

Tappo maschio NPT

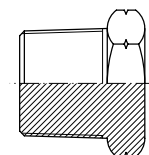

THREAD ROSCA	Part n° Referencia	€
1/4" NPT	N107004	0,92
3/8" NPT	N107006	1,08
1/2" NPT	N107008	1,66
3/4" NPT	N107012	3,20
1" NPT	N107016	4,91



# Adaptadores NPT

NPT Adaptors  
Adapteurs NPT  
Adattatori NPT

## Tapón Allen NPT

NPT Allen plug

Bouchon Allen NPT

Tappo Allen NPT

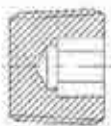

THREAD ROSCA	Part nº Referencia	€
1/4" NPT	N107104	1,43
3/8" NPT	N107106	2,03
1/2" NPT	N107108	2,48
3/4" NPT	N107112	3,09
1" NPT	N107116	5,19

## Adaptador Hembra Fija NPT - Hembra Fija NPT

NPT adaptor fixed female - fixed female NPT

Adapteur femelle fixe NPT - femelle fixe NPT

Adattatore femmina fissa NPT - femmina fissa NPT



THREAD ROSCA	Part nº Referencia	€
1/4" NPT	N103100404	2,33
3/8" NPT	N103100606	2,94
1/2" NPT	N103100808	5,04
3/4" NPT	N103101212	6,85
1" NPT	N103101616	10,16

## Codo 90° M-M NPT

90° elbow male NPT - male NPT

Coude 90° mâle NPT - mâle NPT

Adattatore a 90° maschio - maschio NPT

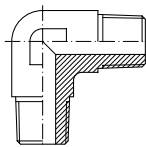

THREAD ROSCA	Part nº Referencia	€
1/8" NPT	N119002	2,22
1/4" NPT	N119004	2,68
3/8" NPT	N119006	3,21
1/2" NPT	N119008	5,13
3/4" NPT	N119012	8,11
1" NPT	N119016	13,24
1 1/4" NPT	N119020	22,65
1 1/2" NPT	N119024	31,99
2" NPT	N119032	66,28

## Codo 90° HF-HF NPT

90° elbow fixed female NPT - fixed female NPT

Coude 90° femelle fixe NPT - femelle fixe NPT

Adattatore a 90° femmina fissa - femmina fissa NPSM

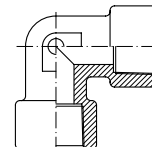

THREAD ROSCA	Part nº Referencia	€
1/8" NPT	N119602	2,27
1/4" NPT	N119604	3,52
3/8" NPT	N119606	4,52
1/2" NPT	N119608	7,27
3/4" NPT	N119612	11,86
1" NPT	N119616	17,68
1 1/4" NPT	N119620	26,17
1 1/2" NPT	N119624	48,06
2" NPT	N119632	85,56

## Codo 90 Macho NPT (60°) - H.G. NPSM (60°)

90° elbow male NPT 60 - swivel female NPSM 60

Coude 90° mâle NPT 60° - femelle tournante NPSM 60°

Adattatore a 90° maschio NPT 60 - femmina girevole NPSM 60



THREAD ROSCA	Part nº Referencia	€	
M 1/4" NPT	F 1/4" NPSM	N11930404	4,74
M 3/8" NPT	F 3/8" NPSM	N11930606	6,25
M 1/2" NPT	F 1/2" NPSM	N11930808	7,98
M 3/4" NPT	F 3/4" NPSM	N11931212	11,82
M 1" NPT	F 1" NPSM	N11931616	18,67

## Codo 45 Macho NPT (60°) - Macho NPT (60°)

45° elbow male NPT 60 - male NPT 60

Coude 45° mâle NPT 60° - mâle NPT 60°

Adattatore a 45° maschio 60 - maschio NPT 60



THREAD ROSCA	Part nº Referencia	€
1/4" NPT	N11980404	3,39
3/8" NPT	N11980606	4,59
1/2" NPT	N11980808	6,55
3/4" NPT	N11981212	10,01
1" NPT	N11981616	15,88

# Adaptadores NPT

NPT Adaptors  
Adaptateurs NPT  
Adattatori NPT

## Codo 45 Hembra Fija NPT - Hembra Fija NPT

45° elbow fixed female NPT - fixed female NPT

Coude 45° femelle fixe NPT - femelle fixe NPT

Adattatore a 45° femmina fissa 60 - femmina fissa NPT 60

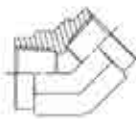

THREAD ROSCA	Part nº Referencia	€
1/4" NPT	N11960404	5,19
3/8" NPT	N11960606	6,25
1/2" NPT	N11960808	8,43
3/4" NPT	N11961212	12,42
1" NPT	N11961616	20,77

## Codo 45 Macho NPT (60°) - H.G. NPSM (60°)

45° elbow male NPT 60° - swivel female NPS 60°

Coude 45° mâle NPT 60° - swivel female NPSM 60°

Adattatore a 45° maschio NPT 60 - femmina girevole NPSM 60



THREAD ROSCA		Part nº Referencia	€
M 1/4" NPT	F 1/4" NPSM	N13930404	5,15
M 3/8" NPT	F 3/8" NPSM	N13930606	6,79
M 1/2" NPT	F 1/2" NPSM	N13930808	8,67
M 3/4" NPT	F 3/4" NPSM	N13931212	12,85
M 1" NPT	F 1" NPSM	N13931616	20,29

## T M-M-M NPT

NPT male tee

Té mâle NPT

Adattatore a T maschio-maschio-maschio NPT

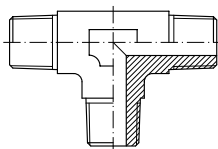

THREAD ROSCA	Part nº Referencia	€
1/8" NPT	N122002	3,41
1/4" NPT	N122004	3,60
3/8" NPT	N122006	4,54
1/2" NPT	N122008	8,88
3/4" NPT	N122012	14,68
1" NPT	N122016	19,82
1" 1/4 NPT	N122020	46,44
3/4" NPT	N122024	75,12
2" NPT	N122032	167,47

## T HF-HF-HF NPT

NPT fixed female tee

Té femelle fixe NPT

Adattatore a T femmina fissa-femmina fissa-femmina fissa NPT

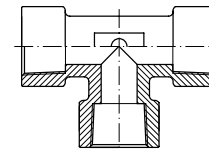

THREAD ROSCA	Part nº Referencia	€
1/8" NPT	N122602	3,98
1/4" NPT	N122604	4,52
3/8" NPT	N122606	6,81
1/2" NPT	N122608	11,63
3/4" NPT	N122612	16,23
1" NPT	N122616	24,87
1" NPT	N122620	47,64
1" 1/2 NPT	N122624	107,48
2" NPT	N122632	178,01

NUEVOS  
NEW

# NUEVOS RACORES HIDRÁULICOS

NEW HYDRAULIC FITTINGS

Tipo Rosca:  
Thread Type:



BSP/BSPT

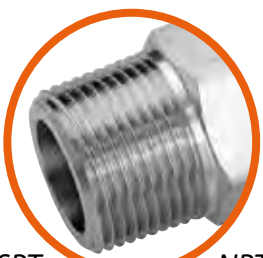

NPT



JIC



ORFS

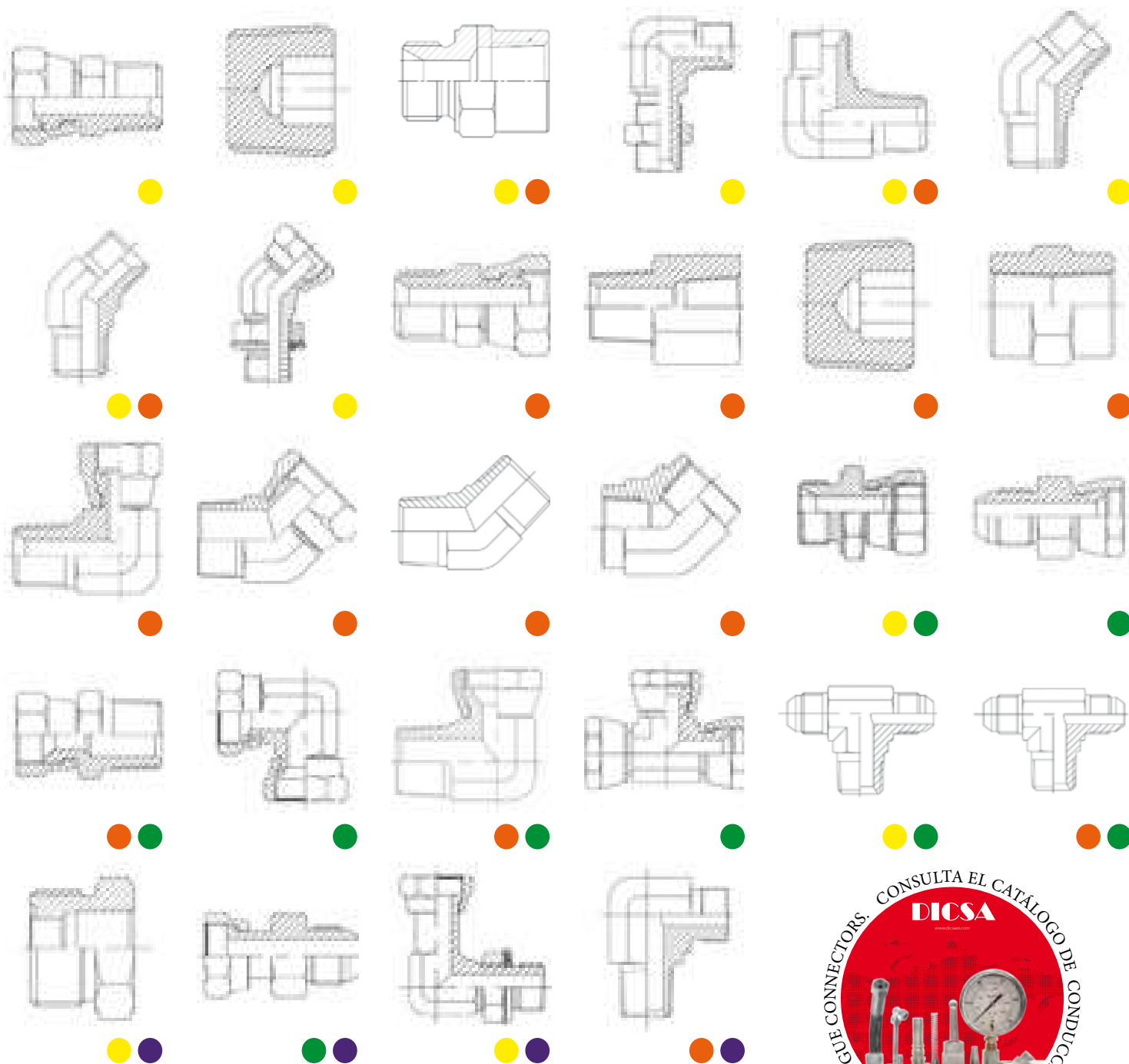

## Accesorios ORFS

*ORFS Accessories*

Accessoires ORFS

*Accessori ORFS*

## Accesorios ORFS

*ORFS*

Accessoires ORFS

*ORFS*

279

2

# Accesorios ORFS

ORFS  
Accessoires ORFS  
ORFS

## ORFS Rectos / Straight ORFS / ORFS Droits / Raccordi diritti ORFS

| 279

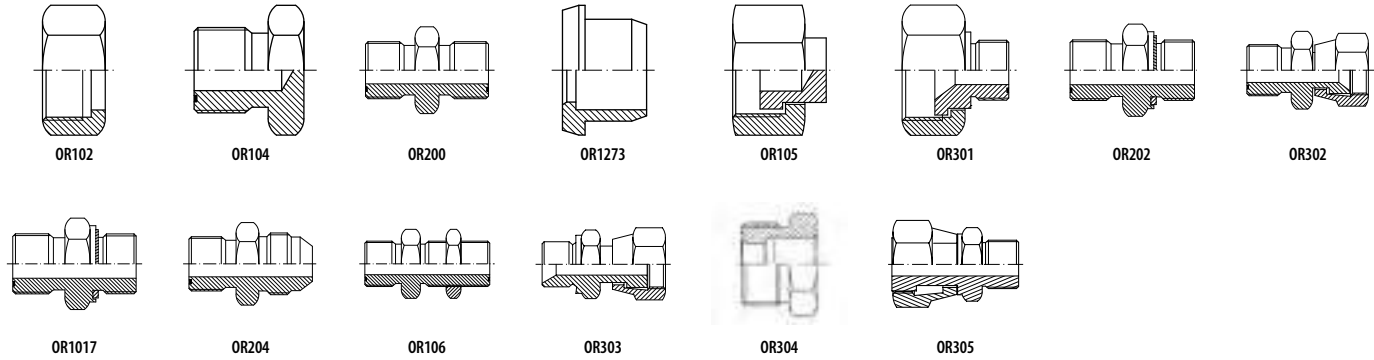

## Codos 45° ORFS / ORFS 45° Elbows / Coude 45° ORFS / Raccordi a 45° ORFS

| 281

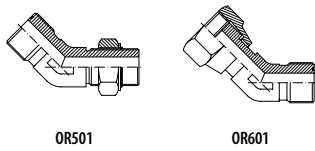

## Codos 90° ORFS / ORFS 90° Elbows / Coude 90° ORFS / Raccordi a 90° ORFS

| 282

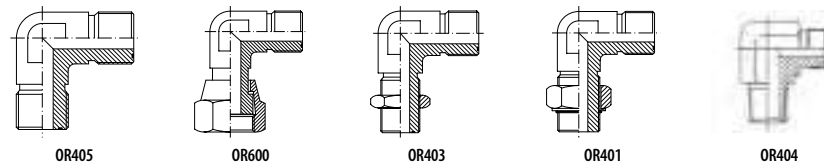

## Te ORFS / ORFS Tees / Tés ORFS / Raccordi a T ORFS

| 283

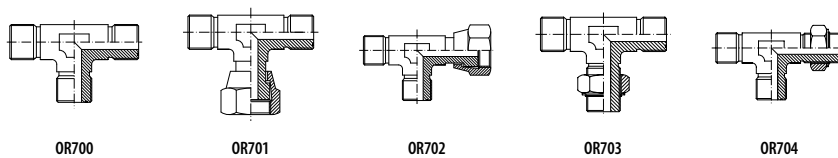

# Accesorios ORFS

ORFS  
Accessoires ORFS  
ORFS

Adaptors

ORFS Accessories

Quick-release couplings

Ball valves, diverters and swivel fittings

Protections

## Tuerca ORFS

ORFS Nut

Ecrou ORFS

Dado ORFS

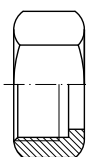

PIPE TUBO	THREAD ROSCA	Part nº Referencia	€
6-8	ORFS 9/16"-18h	OR1020400	0,74
10	ORFS 11/16"-16h	OR1020600	1,08
12	ORFS 13/16"-16h	OR1020800	1,26
14-15-16	ORFS 1"-14h	OR1021000	1,70
18-20	ORFS 1"3/16-12h	OR1021200	4,70
22-25	ORFS 1"7/16-12h	OR1021600	5,08
28-30-32	ORFS 1"11/16-12h	OR1022000	9,09
35-38	ORFS 2"-12h	OR1022400	11,01

## Tapón macho ORFS

ORFS Male plug

Bouchon mâle ORFS

Tappo maschio ORFS

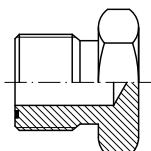

THREAD ROSCA	Part nº Referencia	€
ORFS 9/16"-18h	OR1040400	1,55
ORFS 11/16"-16h	OR1040600	1,71
ORFS 13/16"-16h	OR1040800	2,12
ORFS 1"-14h	OR1041000	2,69
ORFS 1"3/16-12h	OR1041200	3,92
ORFS 1"7/16-12h	OR1041600	6,58
ORFS 1"11/16-12h	OR1042000	9,14
ORFS 2"-12h	OR1042400	17,91

## Adaptador macho ORFS

ORFS-ORFS Male

Mâle ORFS-ORFS

Adattatore maschio ORFS

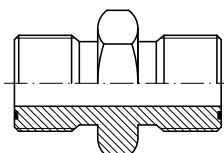

THREAD ROSCA	Part nº Referencia	€
ORFS 9/16"-18h	OR2000404	2,56
ORFS 11/16"-16h	OR2000604	2,62
ORFS 11/16"-16h	OR2000606	3,20
ORFS 13/16"-16h	OR2000806	3,93
ORFS 13/16"-16h	OR2000808	3,93
ORFS 1"-14h	OR2001008	4,93
ORFS 1"-14h	OR2001010	4,93
ORFS 1"3/16-12h	OR2001210	5,76
ORFS 1"3/16-12h	OR2001212	8,09
ORFS 1"7/16-12h	OR2001612	12,34
ORFS 1"7/16-12h	OR2001616	11,01
ORFS 1"11/16-12h	OR2002016	24,58
ORFS 1"11/16-12h	OR2002020	24,21
ORFS 2"-12h	OR2002424	28,23

## Cono soldar

ORFS Welding cone

Collet à souder ORFS

Ogiva a saldare ORFS

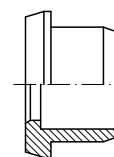

PIPE TUBO	THREAD ROSCA	Part nº Referencia	€
6	ORFS 9/16"-18h	OR12730406	1,51
10	ORFS 11/16"-16h	OR12730610	1,37
12	ORFS 13/16"-16h	OR12730812	1,67
14	ORFS 1"-14h	OR12731014	2,15
15	ORFS 1"-14h	OR12731015	2,15
16	ORFS 1"-14h	OR12731016	2,15
18	ORFS 1"3/16-12h	OR12731218	2,46
20	ORFS 1"3/16-12h	OR12731220	2,09
30	ORFS 1"11/16-12h	OR12732030	9,58
38	ORFS 2"-12h	OR12732438	11,64

## Tapón hembra giratoria ORFS

ORFS Female plug

Bouchon femelle ORFS

Tappo femmina ORFS

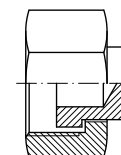

THREAD ROSCA	Part nº Referencia	€
ORFS 9/16"-18h	OR1050400	1,65
ORFS 11/16"-16h	OR1050600	2,19
ORFS 13/16"-16h	OR1050800	2,65
ORFS 1"-14h	OR1051000	3,93
ORFS 1"3/16-12h	OR1051200	5,30
ORFS 1"7/16-12h	OR1051600	6,94
ORFS 1"11/16-12h	OR1052000	14,99
ORFS 2"-12h	OR1052400	18,04

## Adaptador hembra giratoria ORFS-macho ORFS

ORFS Swivel female-ORFS Male

Femelle tournante ORFS-mâle ORFS

Adattatore femmina girevole ORFS-maschio ORFS

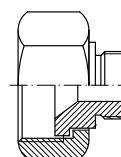

THREAD ROSCA	Part nº Referencia	€
ORFS 11/16"-16h	OR3010604	4,33
ORFS 13/16"-16h	OR3010804	6,17
ORFS 13/16"-16h	OR3010806	5,04
ORFS 1"-14h	OR3011004	8,16
ORFS 1"-14h	OR3011008	8,16
ORFS 1"3/16-12h	OR3011206	9,37
ORFS 1"3/16-12h	OR3011208	9,37
ORFS 1"3/16-12h	OR3011210	9,37
ORFS 1"7/16-12h	OR3011608	13,13
ORFS 1"7/16-12h	OR3011610	13,13
ORFS 1"11/16-12h	OR3012012	17,67
ORFS 1"11/16-12h	OR3012016	17,67

# Accesorios ORFS

ORFS  
Accessoires ORFS  
ORFS

## Adaptador macho ORFS-BSP

ORFS-BSP Male

Mâle ORFS-BSP

Adattatore maschio ORFS-BSP

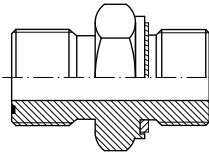

THREAD ROSCA		Part n° Referencia	€
ORFS 9/16"-18h	BSP 1/8"	OR2020402	2,37
ORFS 9/16"-18h	BSP 1/4"	OR2020404	2,53
ORFS 11/16"-16h	BSP 1/4"	OR2020604	2,74
ORFS 11/16"-16h	BSP 3/8"	OR2020606	2,92
ORFS 13/16"-16h	BSP 3/8"	OR2020806	3,56
ORFS 13/16"-16h	BSP 1/2"	OR2020808	5,03
ORFS 1"-14h	BSP 1/2"	OR2021008	5,48
ORFS 1"3/16-12h	BSP 3/4"	OR2021212	5,76
ORFS 1"7/16-12h	BSP 1"	OR2021616	11,51
ORFS 1"11/16-12h	BSP 1"1/4	OR2022020	22,84
ORFS 2"-12h	BSP 1"1/2	OR2022424	33,83

## Adaptador macho ORFS-hembra giratoria JIC

ORFS Male-JIC Swivel female

Mâle ORFS-femelle tournante JIC

Adattatore maschio ORFS-femmina girevole JIC

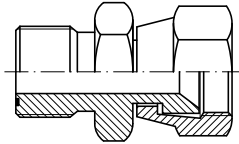

THREAD ROSCA		Part n° Referencia	€
ORFS 9/16"-18h	JIC 7/16"	OR3020404	3,48
ORFS 11/16"-16h	JIC 9/16"	OR3020606	3,97
ORFS 13/16"-16h	JIC 3/4"	OR3020808	4,47
ORFS 1"-14h	JIC 7/8"	OR3021010	11,02
ORFS 1"3/16-12h	JIC 1"1/16	OR3021212	6,03
ORFS 1"7/16-12h	JIC 1"5/16	OR3021616	11,71
ORFS 1"11/16-12h	JIC 1"5/8	OR3022020	21,72
ORFS 2"-12h	JIC 1"7/8	OR3022424	41,23

## Macho ORFS-Métrico

Metric ORFS Male

Mâle ORFS Métrique

Maschio ORFS Metrico

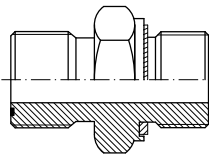

THREAD ROSCA		Part n° Referencia	€
ORFS 9/16"-18h	M12x1.5	OR10170412	4,85
ORFS 11/16"-16h	M14x1.5	OR10170614	4,70
ORFS 11/16"-16h	M16x1.5	OR10170616	5,13
ORFS 13/16"-16h	M18x1.5	OR10170818	4,02
ORFS 1"-14h	M22x1.5	OR10171022	5,21
ORFS 1"7/16-12h	M33x2	OR10171633	10,78
ORFS 1"11/16-12h	M42x2	OR10172042	20,34
ORFS 2"-12h	M48x2	OR10172448	31,74

## Adaptador macho ORFS-JIC

ORFS-JIC Male

Mâle ORFS-JIC

Adattatore maschio ORFS-JIC

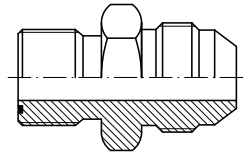

THREAD ROSCA		Part n° Referencia	€
ORFS 9/16"-18h	JIC 7/16"	OR2040404	2,28
ORFS 11/16"-16h	JIC 9/16"	OR2040606	2,47
ORFS 13/16"-16h	JIC 3/4"	OR2040808	3,02
ORFS 1"-14h	JIC 7/8"	OR2041010	4,39
ORFS 1"3/16-12h	JIC 1"1/16	OR2041212	6,58
ORFS 1"7/16-12h	JIC 1"5/16	OR2041616	9,62

## Pasatabiques ORFS

ORFS Bulkhead

Passe-doisson ORFS

Passaparete ORFS

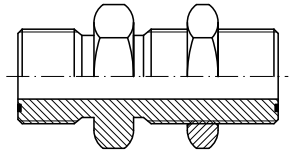

PIPE TUBO	THREAD ROSCA	Part n° Referencia	€
5	ORFS 9/16"-18h	OR1060404	4,57
6,5	ORFS 11/16"-16h	OR1060606	6,44
9,5	ORFS 13/16"-16h	OR1060808	9,69
12,5	ORFS 1"-14h	OR1061010	11,83
16,5	ORFS 1"3/16-12h	OR1061212	17,08
20,5	ORFS 1"7/16-12h	OR1061616	21,79
26	ORFS 1"11/16-12h	OR1062020	33,58
32	ORFS 2"-12h	OR1062424	54,49

## Racor Recto M BSP - H.G. ORFS

BSP male - ORFS swivel female

Mâle BSP-femelle tournante ORFS

Adattatore maschio BSP - femmina girevole ORFS

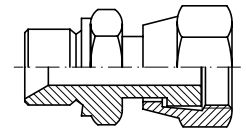

PIPE TUBO	THREAD ROSCA	Part n° Referencia	€	
4,2	1/8" BSP	ORFS 9/16" 18h	OR3030402	8,59
4,2	1/4" BSP	ORFS 9/16" - 18h	OR3030404	8,68
5	1/4" BSP	ORFS 11/16" - 16h	OR3030604	9,93
6,5	3/8" BSP	ORFS 11/16" - 16h	OR3030606	10,87
7,8	3/8" BSP	ORFS 13/16" - 16h	OR3030806	12,18
9	1/2" BSP	ORFS 13/16" - 16h	OR3030808	12,63
11,5	1/2" BSP	ORFS 1" - 14h	OR3031008	15,05
14	3/4" BSP	ORFS 1"3/16 - 12h	OR3031212	20,10
20	1" BSP	ORFS 1"7/16 - 12h	OR3031616	24,64
25	1"1/4 BSP	ORFS 1"11/16 - 12h	OR3032020	31,58
32	1"1/2 BSP	ORFS 2" - 12h	OR3032424	55,37



# Accesorios ORFS

ORFS  
Accessoires ORFS  
ORFS

Adaptors

ORFS Accessories

Quick-release couplings

Ball valves, diverters and swivel fittings

Protections

## Adaptador Macho ORFS - Hembra Fija BSP

ORFS male adaptor - BSP fixed female

Adapteur mâle ORFS - femelle fixe BSP

Adattatore maschio ORFS - femmina fissa BSP



THREAD ROSCA		Part n° Referencia	€
ORFS 9/16"-18 h	1/4" BSP	<b>OR3040404</b>	<b>3,11</b>
ORFS 11/16"-16h	3/8" BSP	<b>OR3040606</b>	<b>3,76</b>
ORFS 13/16"-16 h	1/2" BSP	<b>OR3040808</b>	<b>4,41</b>
ORFS 1"3/16-12 h	3/4" BSP	<b>OR3041212</b>	<b>7,87</b>
ORFS 1"7/16-12 h	1" BSP	<b>OR3041616</b>	<b>11,27</b>

## Adaptador H.G. ORFS - Macho JIC

ORFS swivel female adaptor - JIC male

Adapteur femelle tournante ORFS - mâle JIC

Adattatore femmina girevole ORFS - maschio JIC

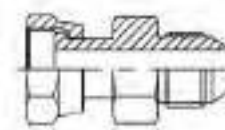

THREAD ROSCA		Part n° Referencia	€
JIC 7/16	ORFS 9/16"-18 h	<b>OR3050404</b>	<b>3,68</b>
JIC 9/16	ORFS 11/16"-16h	<b>OR3050606</b>	<b>4,70</b>
JIC 3/4"	ORFS 13/16"-16 h	<b>OR3050808</b>	<b>5,92</b>
JIC 1"1/16	ORFS 1"3/16-12 h	<b>OR3051212</b>	<b>10,76</b>
JIC 1" 7/16	ORFS 1"7/16-12 h	<b>OR3051616</b>	<b>15,96</b>

## Codo 45° regulable ORFS-BSP

Adjustable 45° elbow ORFS male-BSP male

Coude 45° mâle ORFS-mâle gaz cyl. +o'ring

Raccordo a 45° orientabile ORFS-BSP

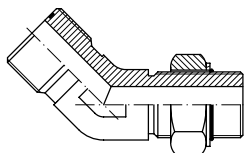

THREAD ROSCA		Part n° Referencia	€
ORFS 9/16"-18h	BSP 1/8"	<b>OR5010402</b>	<b>5,67</b>
ORFS 9/16"-18h	BSP 1/4"	<b>OR5010404</b>	<b>5,94</b>
ORFS 11/16"-16h	BSP 1/4"	<b>OR5010604</b>	<b>6,76</b>
ORFS 11/16"-16h	BSP 3/8"	<b>OR5010606</b>	<b>7,58</b>
ORFS 11/16"-16h	BSP 1/2"	<b>OR5010608</b>	<b>9,05</b>
ORFS 13/16"-16h	BSP 3/8"	<b>OR5010806</b>	<b>10,23</b>
ORFS 1"-14h	BSP 1/2"	<b>OR5011008</b>	<b>12,52</b>
ORFS 1"-14h	BSP 3/4"	<b>OR5011012</b>	<b>15,99</b>
ORFS 1"3/16-12h	BSP 3/4"	<b>OR5011212</b>	<b>16,90</b>
ORFS 1"3/16-12h	BSP 1"	<b>OR5011216</b>	<b>24,49</b>
ORFS 1"7/16-12h	BSP 1"	<b>OR5011616</b>	<b>26,41</b>

## Codo 45° macho ORFS-hembra giratoria ORFS

45° elbow ORFS swivel female-ORFS male

Coude 45° mâle ORFS-femelle tournante ORFS

Raccordo a 45° maschio-femmina girevole ORFS

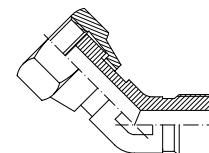

THREAD ROSCA		Part n° Referencia	€
ORFS 9/16"-18h	ORFS 9/16"-18h	<b>OR6010404</b>	<b>6,58</b>
ORFS 11/16"-16h	ORFS 11/16"-16h	<b>OR6010606</b>	<b>8,32</b>
ORFS 13/16"-16h	ORFS 13/16"-16h	<b>OR6010808</b>	<b>10,05</b>
ORFS 1"-14h	ORFS 1"-14h	<b>OR6011010</b>	<b>12,43</b>
ORFS 1"3/16-12h	ORFS 1"3/16-12h	<b>OR6011212</b>	<b>18,18</b>
ORFS 1"7/16-12h	ORFS 1"7/16-12h	<b>OR6011616</b>	<b>30,61</b>
ORFS 1"11/16	ORFS 1"11/16	<b>OR6012020</b>	<b>41,58</b>
ORFS 2"-12h	ORFS 2"-12h	<b>OR6012424</b>	<b>48,61</b>

# Accesorios ORFS

ORFS  
Accessoires ORFS  
ORFS

## Codo 90° ORFS-ORFS

90° Elbow ORFS male-ORFS male

Coude 90° mâle ORFS-mâle ORFS

Raccordo a 90° ORFS-ORFS

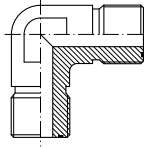

THREAD ROSCA		Part n° Referencia	€
ORFS 9/16"-18h	ORFS 9/16"-18h	<b>OR4050404</b>	<b>7,01</b>
ORFS 11/16"-16h	ORFS 11/16"-16h	<b>OR4050606</b>	<b>7,48</b>
ORFS 13/16"-16h	ORFS 13/16"-16h	<b>OR4050808</b>	<b>9,13</b>
ORFS 1"-14h	ORFS 1"-14h	<b>OR4051010</b>	<b>11,60</b>
ORFS 1"3/16-12h	ORFS 1"3/16-12h	<b>OR4051212</b>	<b>13,67</b>
ORFS 1"7/16-12h	ORFS 1"7/16-12h	<b>OR4051616</b>	<b>41,10</b>
ORFS 1"11/16-12h	ORFS 1"11/16-12h	<b>OR4052020</b>	<b>39,97</b>
ORFS 2"-12h	ORFS 2"-12h	<b>OR4052424</b>	<b>49,58</b>

## Codo 90° macho-hembra giratoria ORFS

90° Elbow ORFS Swivel female-ORFS male

Coude 90° femelle tournante-mâle ORFS

Raccordo a 90° maschio-femmina girevole ORFS

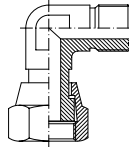

THREAD ROSCA		Part n° Referencia	€
ORFS 9/16"-18h	ORFS 9/16"-18h	<b>OR6000404</b>	<b>6,44</b>
ORFS 11/16"-16h	ORFS 11/16"-16h	<b>OR6000606</b>	<b>7,94</b>
ORFS 13/16"-16h	ORFS 13/16"-16h	<b>OR6000808</b>	<b>8,18</b>
ORFS 1"-14h	ORFS 1"-14h	<b>OR6001010</b>	<b>11,52</b>
ORFS 1"3/16-12h	ORFS 1"3/16-12h	<b>OR6001212</b>	<b>21,56</b>
ORFS 1"7/16-12h	ORFS 1"7/16-12h	<b>OR6001616</b>	<b>34,91</b>
ORFS 1"11/16-12h	ORFS 1"11/16-12h	<b>OR6002020</b>	<b>64,56</b>

## Codo 90° pasatabique ORFS

90° Elbow ORFS Bulkhead

Coude 90° passe-cloison ORFS

Raccordo a 90° passaparete ORFS

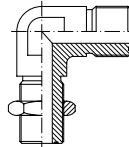

THREAD ROSCA		Part n° Referencia	€
ORFS 9/16"-18h	ORFS 9/16"-18h	<b>OR4030404</b>	<b>13,10</b>
ORFS 11/16"-16h	ORFS 11/16"-16h	<b>OR4030606</b>	<b>18,00</b>
ORFS 1"-14h	ORFS 1"-14h	<b>OR4031010</b>	<b>23,26</b>
ORFS 1"3/16-12h	ORFS 1"3/16-12h	<b>OR4031212</b>	<b>28,72</b>
ORFS 1"7/16-12h	ORFS 1"7/16-12h	<b>OR4031616</b>	<b>50,20</b>
ORFS 1"11/16-12h	ORFS 1"11/16-12h	<b>OR4032020</b>	<b>58,01</b>
ORFS 2"-12h	ORFS 2"-12h	<b>OR4032424</b>	<b>78,38</b>

## Codo 90° regulable ORFS-BSP

Adjustable 90° elbow ORFS male -BSP male

Coude 90° mâle ORFS + mâle gaz cyl. +o'ring

Raccordo a 90° regolabile ORFS-BSP

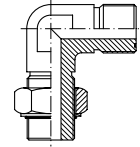

THREAD ROSCA		Part n° Referencia	€
ORFS 9/16"-18h	BSP 1/8"	<b>OR4010402</b>	<b>9,44</b>
ORFS 9/16"-18h	BSP 1/4"	<b>OR4010404</b>	<b>9,31</b>
ORFS 9/16"-18h	BSP 3/8"	<b>OR4010406</b>	<b>16,24</b>
ORFS 11/16"-16h	BSP 1/4"	<b>OR4010604</b>	<b>8,72</b>
ORFS 11/16"-16h	BSP 3/8"	<b>OR4010606</b>	<b>9,72</b>
ORFS 13/16"-16h	BSP 1/4"	<b>OR4010804</b>	<b>9,85</b>
ORFS 13/16"-16h	BSP 1/2"	<b>OR4010808</b>	<b>12,33</b>
ORFS 1"-14h	BSP 3/8"	<b>OR4011006</b>	<b>13,15</b>
ORFS 1"-14h	BSP 1/2"	<b>OR4011008</b>	<b>12,84</b>
ORFS 1"3/16-12h	BSP 1/2"	<b>OR4011208</b>	<b>16,24</b>
ORFS 1"3/16-12h	BSP 3/4"	<b>OR4011212</b>	<b>17,10</b>
ORFS 1"3/16-12h	BSP 1"	<b>OR4011216</b>	<b>36,25</b>
ORFS 1"7/16-12h	BSP 1"	<b>OR4011616</b>	<b>29,24</b>
ORFS 1"7/16-12h	BSP 1" 1/4	<b>OR4011620</b>	<b>47,78</b>
ORFS 1"11/16-12h	BSP 1"	<b>OR4012016</b>	<b>41,31</b>
ORFS 1"11/16-12h	BSP 1"1/4	<b>OR4012020</b>	<b>47,78</b>
ORFS 2"-12h	BSP 1"1/2	<b>OR4012424</b>	<b>61,06</b>

## Codo 90° Macho ORFS - Macho NPT (60°)

90° Elbow ORFS male - NPT male (60°)

Coude 90° mâle ORFS - mâle NPT (60°)

Raccordo a 90° maschio ORFS - maschio NPT (60°)



THREAD ROSCA		Part n° Referencia	€
ORFS 9/16"-18 h	1/4" NPT	<b>OR4040404</b>	<b>3,97</b>
ORFS 11/16"-16h	3/8" NPT	<b>OR4040606</b>	<b>5,42</b>
ORFS 13/16"-16 h	1/2" NPT	<b>OR4040808</b>	<b>8,31</b>
ORFS 1"3/16-12 h	3/4" NPT	<b>OR4041212</b>	<b>16,98</b>
ORFS 1"7/16-12 h	1" NPT	<b>OR4041616</b>	<b>25,43</b>

# Accessorios ORFS

ORFS  
Accessoires ORFS  
ORFS

Adaptors

ORFS Accessories

Quick-release couplings

Ball valves, diverters and swivel fittings

Protections

## Te Macho ORFS

*Tee ORFS male*

Té égal mâle ORFS

*Raccordo a T maschio ORFS*

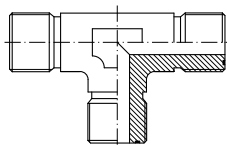

THREAD ROSCA	Part nº Referencia	€
ORFS 9/16"-18h	OR7000404	8,10
ORFS 11/16"-16h	OR7000606	10,57
ORFS 13/16"-16h	OR7000808	12,67
ORFS 1"-14h	OR7001010	15,01
ORFS 1"3/16-12h	OR7001212	16,45
ORFS 1"7/16-12h	OR7001616	39,35
ORFS 1"11/16-12h	OR7002020	41,20
ORFS 2"-12h	OR7002424	73,38

## Te macho-hembra giratoria-macho ORFS

*ORFS Tee male-swivel female-male*

Té mâle-femelle tournante-mâle ORFS

*Raccordo a T maschio-maschio-femmina girevole centrale ORFS*

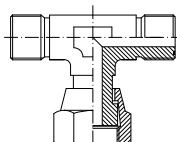

THREAD ROSCA	Part nº Referencia	€
ORFS 9/16"-18h	OR7010404	13,61
ORFS 11/16"-16h	OR7010606	16,24
ORFS 13/16"-16h	OR7010808	16,53
ORFS 1"-14h	OR7011010	22,36
ORFS 1"3/16-12h	OR7011212	29,45
ORFS 1"7/16-12h	OR7011616	55,64
ORFS 1"11/16-12h	OR7012020	81,01
ORFS 2"-12h	OR7012424	108,50

## Te macho-macho-hembra giratoria ORFS

*ORFS Tee male-male-swivel female*

Té mâle-mâle-femelle tournante ORFS

*Raccordo a T maschio-maschio-femmina girevole laterale ORFS*

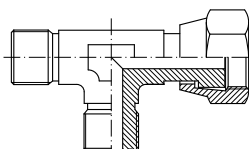

THREAD ROSCA	Part nº Referencia	€
ORFS 9/16"-18h	OR7020404	6,94
ORFS 11/16"-16h	OR7020606	8,50
ORFS 13/16"-16h	OR7020808	11,88
ORFS 1"-14h	OR7021010	14,44
ORFS 1"3/16-12h	OR7021212	21,47
ORFS 1"7/16-12h	OR7021616	35,09
ORFS 1"11/16-12h	OR7022020	58,56

## Te macho ORFS-macho BSP-macho ORFS

*Tee ORFS male-BSP male-ORFS male*

Té mâle ORFS-mâle BSP-mâle ORFS

*Raccordo a T maschio ORFS-maschio BSP-maschio ORFS*

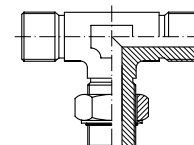

THREAD ROSCA		Part nº Referencia	€
ORFS 9/16"-18h	BSP 1/8"	OR7030402	5,63
ORFS 9/16"-18h	BSP 1/4"	OR7030404	8,57
ORFS 11/16"-16h	BSP 1/4"	OR7030604	8,41
ORFS 11/16"-16h	BSP 3/8"	OR7030606	9,88
ORFS 13/16"-16h	BSP 3/8"	OR7030806	9,06
ORFS 1"-14h	BSP 1/2"	OR7031008	13,47
ORFS 1"-14h	BSP 3/4"	OR7031012	18,44
ORFS 1"3/16-12h	BSP 3/4"	OR7031212	19,75
ORFS 1"7/16-12h	BSP 1"	OR7031616	31,26
ORFS 1"11/16-12h	BSP 1"1/4"	OR7032020	44,32

## Te macho ORFS-macho ORFS-macho BSP

*Tee ORFS male-ORFS male-BSP male*

Té mâle ORFS-mâle ORFS-mâle BSP

*Raccordo a T maschio ORFS-maschio ORFS-maschio BSP*

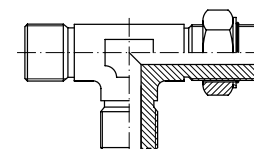

THREAD ROSCA		Part nº Referencia	€
ORFS 9/16"-18h	BSP 1/8"	OR7040402	12,84
ORFS 9/16"-18h	BSP 1/4"	OR7040404	13,00
ORFS 11/16"-16h	BSP 1/4"	OR7040604	13,00
ORFS 11/16"-16h	BSP 3/8"	OR7040606	16,17
ORFS 1"-14h	BSP 3/4"	OR7041012	25,17
ORFS 1"11/16-12h	BSP 1"1/4"	OR7042020	48,99
ORFS 2"-12h	BSP 1"1/2"	OR7042424	56,03

## Enchufes rápidos

*Quick-release couplings*

Coupleurs rapides

*Innesti rapidi*

### **Enchufes rápidos**

*Quick-release couplings*

Coupleurs rapides

*Innesti rapidi*

290

### **Enchufes rápidos y llaves de paso TrΔle**

*TrΔle quick-release couplings and ball valves*

Coupleurs rapides et robinets TrΔle

*Innesti rapidi e rubinetti TrΔle*

298

### **Multienchufe**

*Multi-way coupling*

Multi-coupleur

*Multinesti*

300

3

# Enchufes rápidos

Quick-release couplings  
Coupleurs rapides  
Innesti rapidi

■ **Enchufes válvula plana / Flat face quick release couplings / Coupleurs rapides à clapet face plane / Innesti a faccia piana**

290

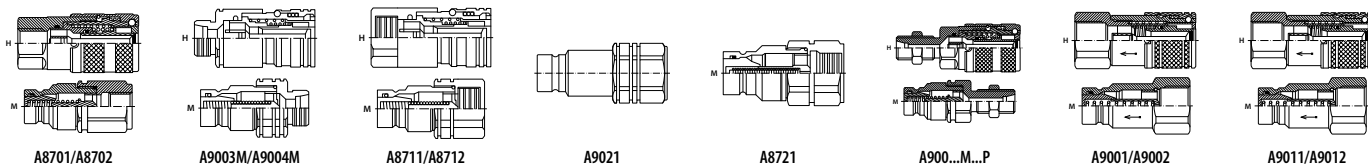

■ **Enchufes autoroscantes / Quick release screw couplings / Coupleurs rapides à visser / Innesti a vite**

291

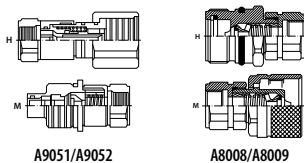

■ **Enchufes punzón / Quick release couplings / Coupleurs rapides à clapet / Innesti a valvola**

292

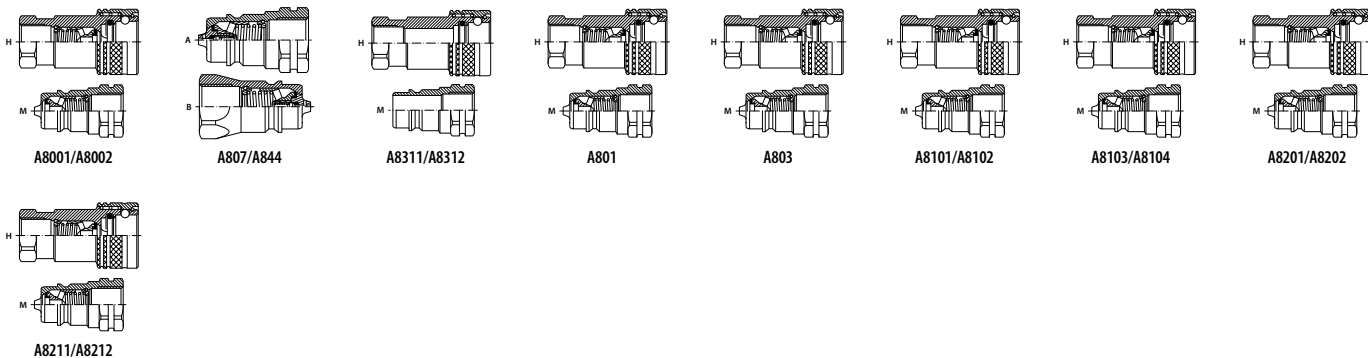

■ **Enchufes Push-Pull / Push-Pull couplings / Coupleurs Push-Pull / Innesti Push-Pull**

294

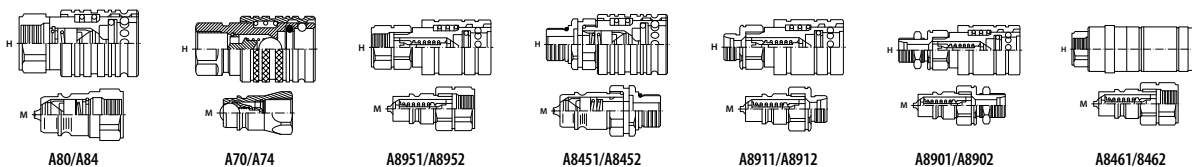

■ **Enchufes de bola / Quick release couplings ball type / Coupleurs rapides à bille / Innesti a sfera**

295

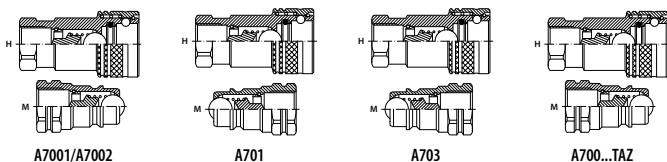

■ **Enchufes altísima presión / Couplings 1500 bar / Coupleurs 1500 bar / Innesti 1500 bar**

295

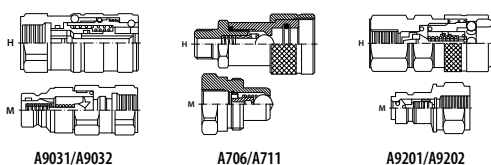

■ **Válvulas de frenado / Brake valves / Valves freinage / Valvole di frenaggio**

296

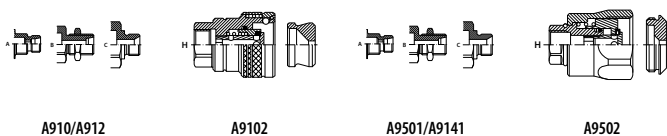

# Enchufes rápidos

Quick-release couplings

Coupleurs rapides

Innesti rapidi

## ■ Enchufes latón / Brass couplings / Coupleurs laiton / Innesti ottone

296

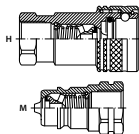

A850

## ■ Accesorios para enchufes / Accessories for couplings / Accessoires pour coupleurs rapides / Accessori per innesto rapido

297



A9901/A9902



A9911/A9912



A9931/A9932



A9941/A9942



A9921



PTFEA



NBRA

# Enchufes rápidos y llaves de paso TrΔle

*TrΔle quick-release couplings and ball valves*

*Coupleurs rapides et robinets TrΔle*

*Innesti rapidi e rubinetti TrΔle*

## ■ Enchufes punzón / Quick release couplings / Coupleurs rapides à clapet / Innesti a valvola

| 298

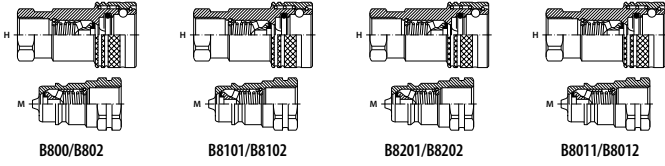

## ■ Enchufes válvula plana y válvulas de frenado / Flat face quick release couplings and brake valves / Coupleurs rapides à clapet face plane et valves freinage / Innesti a faccia piana e valvole di frenaggio

| 298

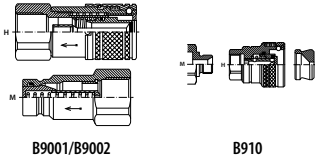

## ■ Llaves de paso / Ball valves / Robinets / Rubinetto a sfera

| 299

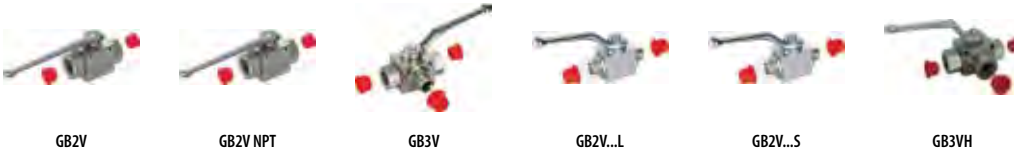



# Multienchufe

Multi-way coupling  
Multi-coupleur  
Multinesti

## ■ Multienchufe 4 vías / Multi-way coupling 4 ways / Multi-coupleur 4 voies / Multinesti 4 vie | 300



MEC4S



MEC4

## ■ Multienchufe 2 vías / Multi-way coupling 2 ways / Multi-coupleur 2 voies / Multinesti 2 vie | 300



MEC2S



MEC2

## ■ Accesorios multienchufe / Multi-way coupling accessories / Accessoires Multi-coupleur / Accessori per multinesti | 300



A930/A940



MEC4

## ■ Multienchufe nuevo diseño / Multi-way coupling new design / Multi-coupleur nouveau design / Multinesti nuovo design | 302



MEN

# Enchufes rápidos

Quick-release couplings  
Coupleurs rapides  
Innesti rapidi

## E.R. Válvula plana para martillos

Flat face quick release coupling inner threads

Coupleur rapide à clapet face plane (marteau)

Innesto rapido a faccia piana per martelli

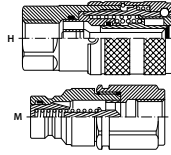

THREAD ROSCA	ISO SIZE TAMAÑO ISO	C. E.	Part nº Referencia	€
1/4" BSP	6.3	M	A870104	16,47
3/8" BSP	10	M	A870106	17,77
1/2" BSP	10	M	A870108	18,14
3/4" BSP	12.5	M	A870112	32,93
1" BSP	19	M	A870116	63,25
1"1/4 BSP	25	M	A870120	104,55
1/4" BSP	6.3	F	A870204	34,61
3/8" BSP	10	F	A870206	42,19
1/2" BSP	10	F	A870208	42,19
3/4" BSP	12.5	F	A870212	57,24
1" BSP	19	F	A870216	119,19
1"1/4 BSP	25	F	A870220	195,04

## E.R. Válvula plana para martillos (rosca Métrica)

Flat face coupling (Metric thread)

Coupleur rapide à clapet face plane (filetage Métrique)

Innesto a faccia piana (Metrico)

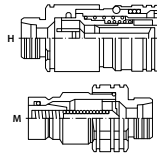

THREAD ROSCA	ISO SIZE TAMAÑO ISO	C. E.	Part nº Referencia	€
M16X1.5-10L	6.3	M	A9003M16	17,76
M18X1.5-12L	10	M	A9003M18	18,60
M22X1.5-15L	10	M	A9003M22	19,56
M26X1.5-18L	12.5	M	A9003M26	39,46
M16X1.5-10L	6.3	F	A9004M16	48,14
M18X1.5-12L	10	F	A9004M18	54,12
M22X1.5-15L	10	F	A9004M22	56,94
M26X1.5-18L	12.5	F	A9004M26	81,18

## E.R. Válvula plana para martillos (rosca UNF)

Flat face quick release coupling inner threads (UNF thread)

Coupleur rapide à clapet face plane pour marteau (filetage UNF)

Innesto rapido a faccia piana per martelli (filetatura UNF)

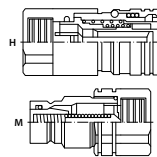

THREAD ROSCA	ISO SIZE TAMAÑO ISO	C. E.	Part nº Referencia	€
9/16"-18h UNF	6.3	M	A87110906	16,47
9/16"-18h UNF	10	M	A87110913	17,51
3/4"-16h UNF	10	M	A87111213	25,09
7/8"-14h UNF	12.5	M	A87111420	36,59
1"1/16-12h UNF	16	M	A87111722	38,42
1"1/16-12h UNF	19	M	A87111725	63,25
9/16"-18h UNF	6.3	F	A87120906	43,91
9/16"-18h UNF	10	F	A87120913	52,80
3/4"-16h UNF	10	F	A87121213	56,46
7/8"-14h UNF	12.5	F	A87121420	79,98
1"1/16-12h UNF	16	F	A87121722	87,82
1"1/16-12h UNF	19	F	A87121725	131,73

## E.R. Válvula plana Ecológico acoplamiento en presión

Flat face quick release coupling connectable u/ pressure

Coupleur rapide à clapet face plane "Ecologique" pression

Innesto rapido a faccia piana Ecologica innestabile in pressione

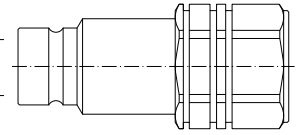

THREAD ROSCA	ISO SIZE TAMAÑO ISO	C. E.	Part nº Referencia	€
1/4" BSP	6.3	M	A902104	65,34
3/8" BSP	10	M	A902106	62,73
1/2" BSP	10	M	A902108	62,73
3/4" BSP	12.5	M	A902112	101,94
1" BSP	19	M	A902116	145,85

Se montan con enchufe hembra A870... / To assemble with female coupling A870... / À monter avec coupleur femelle A870... / Per montare con innesto femmina A870...

## E.R. Válvula plana para martillos altas pulsaciones

Flat face quick release coupling inner threads high pulsations

Coupleur rapide à clapet face plane (marteau) hautes pulsations

Innesto rapido a faccia piana per martelli alti pulsazioni

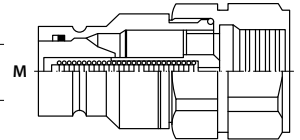

THREAD ROSCA	ISO SIZE TAMAÑO ISO	C. E.	Part nº Referencia	€
3/4" BSP	19	M	A872112	83,64
1" BSP	25	M	A872116	83,64

Se montan con enchufe hembra A870 / To assemble with female coupling A870 / À monter avec coupleur femelle A870 / Per montare con innesto femmina A870

## E.R. Válvula plana pasatabique para martillos (rosca Métrica)

Flat face coupling bulkhead (Metric thread)

Coupleur rapide à clapet face plane passe cloison (filetage Métrique)

Innesto a faccia piana passaparete (Metrico)

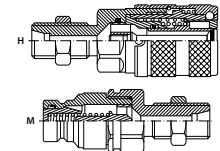

THREAD ROSCA	ISO SIZE TAMAÑO ISO	C. E.	Part nº Referencia	€
M16x1.5	6.3	M	A9001M16P	19,24
M18x1.5	10	M	A9001M18P	20,91
M22x1.5	10	M	A9001M22P	20,91
M26x1.5	12.5	M	A9001M26P	48,88
M16x1.5	6.3	F	A9002M16P	51,07
M18x1.5	10	F	A9002M18P	57,50
M22x1.5	10	F	A9002M22P	61,16
M26x1.5	12.5	F	A9002M26P	87,82

# Enchufes rápidos

Quick-release couplings  
Coupleurs rapides  
Innesti rapidi

Adaptors

ORFS Accessories

Quick-release couplings

Ball valves, diverters and swivel fittings

Protections

## E.R. Válvula plana Ecológico (rosca BSP)

BSP Ecological flat face coupling

Coupleur rapide à clapet face plane  
"Ecologique" filetage BSP

Innesto rapido a faccia piana Ecologico BSP

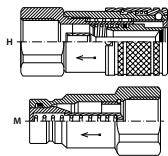

THREAD ROSCA	ISO SIZE TAMAÑO ISO	C. E.	Part nº Referencia	€
1/4" BSP	6.3	M	A900104	15,42
3/8" BSP	10	M	A900106	15,68
1/2" BSP	10	M	A900108	15,68
3/4" BSP	12.5	M	A900112	33,46
1" BSP	19	M	A900116	57,50
1"1/4 BSP	25	M	A900120	109,78
1" 1/2 BSP	40	M	A900124	254,06
2" BSP	50	M	A900132	647,16
1/4" BSP	6.3	F	A900204	32,36
3/8" BSP	10	F	A900206	36,59
1/2" BSP	10	F	A900208	36,59
3/4" BSP	12.5	F	A900212	52,22
1" BSP	19	F	A900216	121,28
1"1/4 BSP	25	F	A900220	193,94
1"1/2 BSP	40	F	A900224	428,66
2" BSP	50	F	A900232	930,50

## E.R. Válvula plana Ecológico (rosca NPT)

NPT Ecological flat face coupling

Coupleur rapide à clapet face plane  
"Ecologique" filetage NPT

Innesto rapido a faccia piana Ecologico NPT

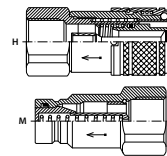

THREAD ROSCA	ISO SIZE TAMAÑO ISO	C. E.	Part nº Referencia	€
1/4" NPT	6.3	M	A901104	15,42
3/8" NPT	10	M	A901106	15,68
1/2" NPT	10	M	A901108	15,68
3/4" NPT	12.5	M	A901112	33,46
1" NPT	19	M	A901116	57,50
1"1/4 NPT	25	M	A901120	109,78
1"1/2 NPT	40	M	A901124	219,56
2" NPT	50	M	A901132	647,16
1/4" NPT	6.3	F	A901204	36,59
3/8" NPT	10	F	A901206	38,16
1/2" NPT	10	F	A901208	38,16
3/4" NPT	12.5	F	A901212	58,55
1" NPT	19	F	A901216	138,01
1"1/4 NPT	25	F	A901220	193,94
1"1/2 NPT	40	F	A901224	386,84
2" NPT	50	F	A901232	930,50

## E.R. Válvula plana Autoroscantes acoplamiento en presión (rosca BSP)

BSP flat face screw coupling w/pressure

Coupleur rapide à clapet face plane à visser  
pression (filetage BSP)

Innesto rapido faccia piana a vite in pressione

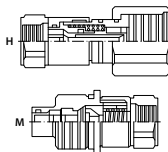

THREAD ROSCA	ISO SIZE TAMAÑO ISO	C. E.	Part nº Referencia	€
1/4" BSP	6.3	M	A905104	82,59
3/8" BSP	10	M	A905106	86,25
1/2" BSP	12.5	M	A905108	99,32
3/4" BSP	16	M	A905112	103,50
1" BSP	19	M	A905116	128,07
1" 1/4 BSP	25	M	A905120	223,74
1" 1/2 BSP	40	M	A905124	418,20
1/4" BSP	6.3	F	A905204	72,14
3/8" BSP	10	F	A905206	67,96
1/2" BSP	12.5	F	A905208	94,10
3/4" BSP	16	F	A905212	110,82
1" BSP	19	F	A905216	143,76
1" 1/4 BSP	25	F	A905220	230,01
1" 1/2 BSP	40	F	A905224	538,43

## E.R. Punzón Autoroscantes acoplamiento en presión (rosca BSP)

BSP Quick release screw coupling

Coupleur rapide à visser taraudage norme DIN  
forme y filetage BSP

Innesto rapido a vite (BSP)

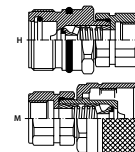

THREAD ROSCA	ISO SIZE TAMAÑO ISO	C. E.	Part nº Referencia	€
1/4" BSP	10	M	A800804	19,08
3/8" BSP	10	M	A800806	19,08
1/2" BSP	12.5	M	A800808	19,86
3/4" BSP	19	M	A800812	46,53
1" BSP	25	M	A800816	58,03
1"1/4 BSP	31.5T	M	A805820	214,33
1"1/2 BSP	31.5T	M	A805824	209,10
1/4" BSP	10	F	A800904	19,08
3/8" BSP	10	F	A800906	19,08
1/2" BSP	12.5	F	A800908	19,19
3/4" BSP	19	F	A800912	45,06
1" BSP	25	F	A800916	49,14
1"1/4 BSP	31.5T	F	A805920	170,94
1"1/2 BSP	31.5T	F	A805924	167,28

# Enchufes rápidos

Quick-release couplings  
Coupleurs rapides  
Innesti rapidi

## E.R. Punzón ISO A

ISO A Quick release coupling

Coupleur rapide à clapet norme ISO A

Innesto rapido a valvola ISO A

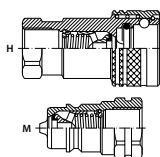

THREAD ROSCA	ISO SIZE TAMAÑO ISO	C. E.	Part n° Referencia	€
1/4" BSP	6.3	M	A800104	6,01
3/8" BSP	10	M	A800106	6,33
1/2" BSP	12.5	M	A800108	6,33
3/4" BSP	20	M	A800112	12,02
1" BSP	25	M	A800116	27,71
1"1/4 BSP	31.5	M	A800120	80,50
1"1/2 BSP	40	M	A800124	109,26
2" BSP	50	M	A800132	186,10
1/4" BSP	6.3	F	A800204	12,55
3/8" BSP	10	F	A800206	14,11
1/2" BSP	12.5	F	A800208	17,25
3/4" BSP	20	F	A800212	26,14
1" BSP	25	F	A800216	57,50
1"1/4 BSP	31.5	F	A800220	165,19
1"1/2 BSP	40	F	A800224	222,69
2" BSP	50	F	A800232	515,95
M22X1.5	12.5	M	A802122	7,06
M22X1.5	12.5	F	A802222	18,30

## E.R. Punzón ISO A -acoplamiento a presión residual

ISO A Quick release coupling (coupling under residual pressure)

Coupleur rapide à clapet accouplable sous pression résiduelle

Innesto rapido a valvole ISO a innestabili in pressione residua

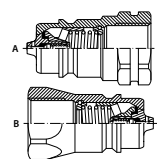

THREAD ROSCA	ISO SIZE TAMAÑO ISO	C. E.	Part n° Referencia	€
1/2" BSP	12.5	M (Tipo B)	A807108	14,11
1/2" BSP	12.5	M (Tipo A)	A844108	14,11
1/2" NPT	12.5	M (Tipo A)	A806108	14,11

## E.R. ISO A Paso total

ISO A Quick release coupling free flow

Coupleur rapide à clapet ISO A pass.total

Innesto rapido ISO A passaggio libero

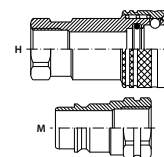

THREAD ROSCA	ISO SIZE TAMAÑO ISO	C. E.	Part n° Referencia	€
1/4" BSP	6.3	M	A831104	2,88
3/8" BSP	10	M	A831106	4,71
1/2" BSP	12.5	M	A831108	5,49
3/4" BSP	20	M	A831112	11,76
1" BSP	25	M	A831116	27,71
1"1/4 BSP	31.5	M	A831120	57,50
1/4" BSP	6.3	F	A831204	10,46
3/8" BSP	10	F	A831206	12,44
1/2" BSP	12.5	F	A831208	17,77
3/4" BSP	20	F	A831212	29,54
1" BSP	25	F	A831216	56,98
1"1/4 BSP	31.5	F	A831220	125,46

## E.R. Punzón ISO A (rosca NPT)

ISO A NPT Quick release coupling

Coupleur rapide à clapet norme ISO A filetage NPT

Innesto rapido a valvola ISO A NPT

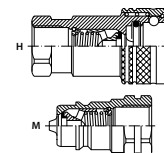

THREAD ROSCA	ISO SIZE TAMAÑO ISO	C. E.	Part n° Referencia	€
1/4" NPT	6.3	M	A801104	6,01
3/8" NPT	10	M	A801106	6,33
1/2" NPT	12.5	M	A801108	7,01
3/4" NPT	20	M	A801112	13,75
1" NPT	25	M	A801116	32,41
1"1/4 NPT	31.5	M	A801120	78,41
1"1/2 NPT	40	M	A801124	109,26
2" NPT	50	M	A801132	186,10
1/4" NPT	6.3	F	A801204	12,55
3/8" NPT	10	F	A801206	14,11
1/2" NPT	12.5	F	A801208	18,30
3/4" NPT	20	F	A801212	29,80
1" NPT	25	F	A801216	60,12
1"1/4 NPT	31.5	F	A801220	176,17
1"1/2 NPT	40	F	A801224	238,37
2" NPT	50	F	A801232	515,95

## E.R. Punzón ISO A (rosca UNF)

ISO A UNF Quick release coupling

Coupleur rapide à clapet norme ISO A filetage UNF

Innesto rapido a valvola ISO B UNF

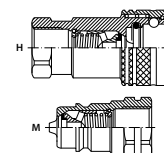

THREAD ROSCA	ISO SIZE TAMAÑO ISO	C. E.	Part n° Referencia	€
3/4" UNF	12.5	M	A803112	6,80
3/4" UNF	12.5	F	A803212	18,30

# Enchufes rápidos

Quick-release couplings  
Coupleurs rapides  
Innesti rapidi

Adaptors

ORFS Accessories

Quick-release couplings

Ball valves, diverters and swivel fittings

Protections

## E.R. Punzón ISO B (rosca BSP)

ISO B Quick release coupling

Coupleur rapide à clapet norme ISO B

Innesto rapido a valvola ISO B

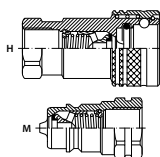

THREAD ROSCA	ISO SIZE TAMAÑO ISO	C. E.	Part n° Referencia	€
1/8" BSP	5	M	A810102	6,80
1/4" BSP	6.3	M	A810104	6,80
3/8" BSP	10	M	A810106	6,38
1/2" BSP	12.5	M	A810108	8,05
3/4" BSP	20	M	A810112	16,21
1" BSP	25	M	A810116	37,43
1"1/4 BSP	40	M	A810120	172,51
1"1/2 BSP	40	M	A810124	172,51
2" BSP	50	M	A810132	459,50
1/8" BSP	5	F	A810202	15,42
1/4" BSP	6.3	F	A810204	15,16
3/8" BSP	10	F	A810206	17,51
1/2" BSP	12.5	F	A810208	27,18
3/4" BSP	20	F	A810212	51,33
1" BSP	25	F	A810216	86,78
1"1/4 BSP	40	F	A810220	232,62
1"1/2 BSP	40	F	A810224	234,19
2" BSP	50	F	A810232	663,89

## E.R. Punzón ISO B (rosca NPT)

ISO B NPT Quick release couplings

Coupleur rapide à clapet norme ISO B NPT

Innesto rapido a valvola ISO B NPT

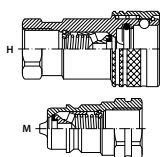

THREAD ROSCA	ISO SIZE TAMAÑO ISO	C. E.	Part n° Referencia	€
1/8" NPT	5	M	A810302	6,27
1/4" NPT	6.3	M	A810304	6,80
3/8" NPT	10	M	A810306	6,38
1/2" NPT	12.5	M	A810308	8,05
3/4" NPT	20	M	A810312	16,21
1" NPT	25	M	A810316	37,43
1"1/4 NPT	40	M	A810320	172,51
1"1/2 NPT	40	M	A810324	172,51
2" NPT	50	M	A810332	460,02
1/8" NPT	5	F	A810402	14,38
1/4" NPT	6.3	F	A810404	15,16
3/8" NPT	10	F	A810406	17,51
1/2" NPT	12.5	F	A810408	27,18
3/4" NPT	20	F	A810412	51,33
1" NPT	25	F	A810416	86,78
1"1/4 NPT	40	F	A810420	235,24
1"1/2 NPT	40	F	A810424	235,24
2" NPT	50	F	A810432	663,89

## E.R. Punzón Serie NV (rosca BSP)

Quick release coupling NV serie

Coupleur rapide à clapet serie NV

Innesto rapido valvola Serie NV

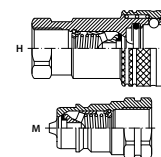

THREAD ROSCA	ISO SIZE TAMAÑO ISO	C. E.	Part n° Referencia	€
1/4" BSP	6.3	M	A820104	5,91
3/8" BSP	10	M	A820106	6,48
1/2" BSP	12.5	M	A800108	6,33
3/4" BSP	19	M	A820112	14,64
1" BSP	25	M	A820116	35,55
1"1/4 BSP	31.5	M	A820120	76,84
1"1/2 BSP	40	M	A820124	108,99
2" BSP	50	M	A820132	347,63
1/4" BSP	6.3	F	A820204	14,11
3/8" BSP	10	F	A820206	16,31
1/2" BSP	12.5	F	A800208	17,25
3/4" BSP	19	F	A820212	36,59
1" BSP	25	F	A820216	67,96
1"1/4 BSP	31.5	F	A820220	167,28
1"1/2 BSP	40	F	A820224	219,56
2" BSP	50	F	A820232	590,71

## E.R. Punzón Serie NV (rosca NPT)

NPT Quick release couplings NV1 serie

Coupleur rapide à clapet serie NV 1 NPT

Innesto rapido a valvola serie NV 1 NPT

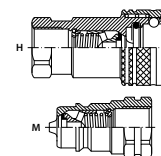

THREAD ROSCA	ISO SIZE TAMAÑO ISO	C. E.	Part n° Referencia	€
1/4" NPT	6.3	M	A821104	6,69
3/8" NPT	10	M	A821106	6,69
1/2" NPT	12.5	M	A801108	7,01
3/4" NPT	19	M	A821112	16,21
1" NPT	25	M	A821116	37,90
1"1/4 NPT	31.5	M	A821120	76,84
1"1/2 NPT	40	M	A821124	108,99
2" NPT	50	M	A821132	347,63
1/4" NPT	6.3	F	A821204	14,38
3/8" NPT	10	F	A821206	16,36
1/2" NPT	12.5	F	A801208	18,30
3/4" NPT	19	F	A821212	39,73
1" NPT	25	F	A821216	67,96
1"1/4 NPT	31.5	F	A821220	167,54
1"1/2 NPT	40	F	A821224	222,69
2" NPT	50	F	A821232	590,71

# Enchufes rápidos

Quick-release couplings  
Coupleurs rapides  
Innesti rapidi

## E.R. Push-Pull Punzón

Push-Pull quick release

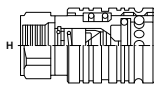

Coupleurs Push-Pull

Innesto rapido a valvola

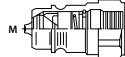

THREAD ROSCA	ISO SIZE TAMAÑO ISO	C. E.	Part n° Referencia	€
1/2" BSP	12.5	M (Tipo B)	<b>A840108</b>	<b>6,80</b>
1/2" NPT	12.5	M	<b>A801108</b>	<b>14,11</b>
M22X1.5	12.5	M	<b>A802122</b>	<b>7,06</b>
3/4" UNF	12.5	M	<b>A803112</b>	<b>6,80</b>
1/2" BSP	12.5	F	<b>A840208</b>	<b>19,49</b>
1/2" NPT	12.5	F	<b>A841208</b>	<b>19,49</b>
M22X1.5	12.5	F	<b>A842222</b>	<b>19,49</b>
3/4" UNF	12.5	F	<b>A843234</b>	<b>19,49</b>

## E.R. Push-Pull bola

Push-Pull coupling ball type



Coupleurs Push-Pull à bille

Innesto rapido a sfera



THREAD ROSCA	ISO SIZE TAMAÑO ISO	C. E.	Part n° Referencia	€
1/2" BSP	12.5	M	<b>A704108</b>	<b>9,20</b>
1/2" NPT	12.5	M	<b>A705108</b>	<b>9,20</b>
3/4" UNF	12.5	M	<b>A703112</b>	<b>9,36</b>
1/2" BSP	12.5	F	<b>A740208</b>	<b>20,86</b>
1/2" NPT	12.5	F	<b>A741208</b>	<b>20,86</b>
3/4" UNF	12.5	F	<b>A702212</b>	<b>20,86</b>

## E.R. Push-Pull Punzón aplic.agric.

Push-Pull quick release coupling agric.application

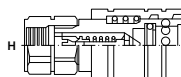

Coupleurs Push-Pull à clapet application agricole

Innesto rapido a valvola applicazioni agricole

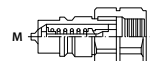

THREAD ROSCA	ISO SIZE TAMAÑO ISO	C. E.	Part n° Referencia	€
1/4" BSP	6.3	M	<b>A895104</b>	<b>26,77</b>
3/8" BSP	10	M	<b>A895106</b>	<b>10,98</b>
1/2" BSP	12.5	M	<b>A895108</b>	<b>8,63</b>
3/4" BSP	19	M	<b>A895112</b>	<b>29,27</b>
1" BSP	25	M	<b>A895116</b>	<b>36,07</b>
1/4" BSP	6.3	F	<b>A895204</b>	<b>60,53</b>
3/8" BSP	10	F	<b>A895206</b>	<b>21,96</b>
1/2" BSP	12.5	F	<b>A895208</b>	<b>19,60</b>
3/4" BSP	19	F	<b>A895212</b>	<b>90,44</b>
1" BSP	25	F	<b>A895216</b>	<b>88,87</b>

## E.R. Push-Pull Punzón aplic. agric. SAE

Push-Pull quick release coupling agric.application SAE

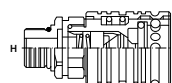

Coupleurs Push-Pull à clapet application agricole SAE

Innesto rapido a valvola applicazioni agricole SAE

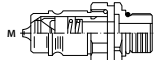

THREAD ROSCA	ISO SIZE TAMAÑO ISO	C. E.	Part n° Referencia	€
3/4" SAE	12.5	M	<b>A845112</b>	<b>9,93</b>
3/4" SAE	12.5	F	<b>A845212</b>	<b>23,11</b>

## E.R. Push-Pull Punzón aplic. agric. M mét.

Push-Pull quick release coupling agric.application Met. M

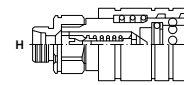

Coupleurs Push-Pull à clapet application agricole M mét.

Innesto rapido a valvola applicazioni agricole M Met.

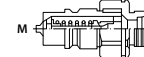

THREAD ROSCA	ISO SIZE TAMAÑO ISO	C. E.	Part n° Referencia	€
M14X1.5-8L	10	M	<b>A89111408</b>	<b>11,50</b>
M16X1.5-10L	10	M	<b>A89111610</b>	<b>10,98</b>
M18X1.5-12L	12.5	M	<b>A89111812</b>	<b>8,57</b>
M20X1.5-12L	12.5	M	<b>A89112012</b>	<b>8,52</b>
M22X1.5-15L	12.5	M	<b>A89112215</b>	<b>8,68</b>
M26X1.5-18L	19	M	<b>A89112618</b>	<b>29,27</b>
M30X1.5-22L	19	M	<b>A89113022</b>	<b>29,27</b>
M14X1.5-8L	10	F	<b>A89121408</b>	<b>21,96</b>
M16X1.5-10L	10	F	<b>A89121610</b>	<b>21,96</b>
M18X1.5-12L	12.5	F	<b>A89121812</b>	<b>19,24</b>
M20X1.5-12L	12.5	F	<b>A89122012</b>	<b>19,24</b>
M22X1.5-15L	12.5	F	<b>A89122215</b>	<b>19,24</b>
M26X1.5-18L	19	F	<b>A89122618</b>	<b>93,57</b>
M30X1.5-22L	19	F	<b>A89123022</b>	<b>93,57</b>

## E.R. Push-Pull Punzón aplic. agric. M mét. pasat.

Push-Pull quick release coupling agric.application Met. M bulkhead

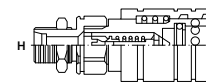

Coupleurs Push-Pull à clapet application agricole M mét. passe-doisson

Innesto rapido a valvola applicazioni agricole M Met. pasaparte



THREAD ROSCA	ISO SIZE TAMAÑO ISO	C. E.	Part n° Referencia	€
M16X1.5-10L	10	M	<b>A89011610</b>	<b>11,50</b>
M18X1.5-12L	12.5	M	<b>A89011812</b>	<b>10,77</b>
M22X1.5-15L	12.5	M	<b>A89012215</b>	<b>10,77</b>
M16X1.5-10L	10	F	<b>A89021610</b>	<b>22,22</b>
M18X1.5-12L	12.5	F	<b>A89021812</b>	<b>21,43</b>
M22X1.5-15L	12.5	F	<b>A89022215</b>	<b>21,59</b>

## E.R. Push-Pull Punzón acoplamiento en presión

Push-Pull quick release coupling u/ pressure

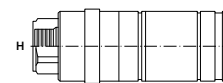

Coupleurs Push-Pull à clapet pression

Innesto rapido a valvola in pressione

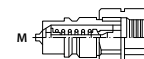

THREAD ROSCA	C. E.	Part n° Referencia	€
1/2" BSP	M	<b>A8461108</b>	<b>16,21</b>
1/2" NPT	M	<b>A8462108</b>	<b>16,21</b>
M22X1.5	M	<b>A8463122</b>	<b>15,68</b>
3/4" UNF	M	<b>A8464134</b>	<b>22,48</b>
1/2" BSP	F	<b>A8461208</b>	<b>28,75</b>
1/2" NPT	F	<b>A8462208</b>	<b>28,75</b>
M22X1.5	F	<b>A8463222</b>	<b>27,97</b>
3/4" UNF	F	<b>A8464234</b>	<b>35,02</b>

# Enchufes rápidos

Quick-release couplings  
Coupleurs rapides  
Innesti rapidi

Adaptors

ORFS Accessories

Quick-release couplings

Ball valves, diverters and swivel fittings

Protections

## E.R. Bola Serie NS (rosca BSP)

BSP Quick release coupling ball type NS Serie

Coupleur rapide à bille série NS

Innesto rapido a sfera BSP Serie NS

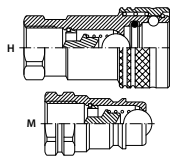

THREAD ROSCA	ISO SIZE TAMAÑO ISO	C. E.	Part n° Referencia	€
1/4" BSP	6.3	M	A700104	6,27
3/8" BSP	10	M	A700106	7,95
1/2" BSP	12.5	M	A700108	8,89
3/4" BSP	19	M	A700112	17,93
1" BSP	25	M	A700116	42,08
1/4" BSP	6.3	F	A700204	12,65
3/8" BSP	10	F	A700206	17,51
1/2" BSP	12.5	F	A700208	20,28
3/4" BSP	19	F	A700212	40,25
1" BSP	25	F	A700216	75,02

## E.R. Bola Serie NS (rosca NPT)

NPT Quick release coupling ball type NS Serie

Coupleur rapide à bille filetage NPT série NS

Innesto rapido a sfera NPT serie NS

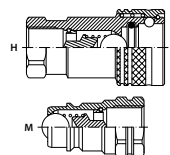

THREAD ROSCA	ISO SIZE TAMAÑO ISO	C. E.	Part n° Referencia	€
1/4" NPT	6.3	M	A701104	6,27
3/8" NPT	10	M	A701106	7,95
3/8" NPT	12.5	M	A701108	8,89
3/4" NPT	19	M	A701112	17,93
1" NPT	25	M	A701116	42,08
1/4" NPT	6.3	F	A701204	12,65
3/8" NPT	10	F	A701206	17,51
1/2" NPT	12.5	F	A701208	20,28
3/4" NPT	19	F	A701212	40,25
1" NPT	25	F	A701216	75,02

## E.R. Válvula plana altísima presión 700 bar

Flat face quick release coupling inner threads high pressure 700 bar

Coupleur rapide à clapet face plane (marteau) haute pression 700 bar

Innesto rapido faccia piana altissima pressione 700 bar

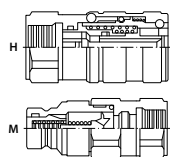

THREAD ROSCA	ISO SIZE TAMAÑO ISO	C. E.	Part n° Referencia	€
1/4" BSP	6.3	M	A903104	36,07
3/8" BSP	6.3	M	A903106	53,06
1/4" BSP	6.3	F	A903204	65,34
3/8" BSP	6.3	F	A903206	112,39

## E.R. Bola Serie NS (rosca UNF)

UNF Quick release coupling ball type NS Serie

Coupleur rapide à bille filetage UNF série NS

Innesto rapido a sfera UNF serie NS

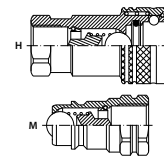

THREAD ROSCA	ISO SIZE TAMAÑO ISO	C. E.	Part n° Referencia	€
3/4" UNF	12.5	M	A703112	9,36
3/4" UNF	12.5	F	A703212	20,39

## E.R. Bola Tipo Taz (gondolas y semirem.)

Quick release coupling ball type Type Taz (gondolas and semi-tows)

Coupleur rapide à bille Type Taz spécial carrocieres

Innesto rapido a sfera tipo Taz per semirimorchio

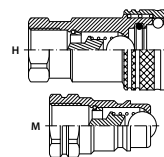

DN	THREAD ROSCA	C. E.	Part n° Referencia	€
19	3/4" BSP	M	A700112TAZ	14,02
25	1" BSP	M	A700116TAZ	21,22
19	3/4" BSP	F	A700212TAZ	32,74
25	1" BSP	F	A700216TAZ	49,50

## E.R. Bola altísima presión 700 bar

Quick release coupling ball type very high pressure (700 bar)

Coupleur rapide à verrouillage vissé haute pression-700 bar

Innesto rapido a sfera 700 bar

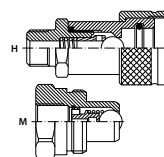

THREAD ROSCA	ISO SIZE TAMAÑO ISO	C. E.	Part n° Referencia	€
3/8" BSP	10	M	A706106	11,50
1/4" NPT	6.3	M	A711104	11,55
3/8" NPT	10	M	A711106	11,50
3/8" BSP	10	F	A706206	28,75
1/4" NPT	6.3	F	A711204	17,56
3/8" NPT	10	F	A711206	19,24

## Enchufes altísima presión 1500 bar BSP

Couplings 1500 bar BSP

Coupleurs 1500 bar BSP

Innesti 1500 bar BSP

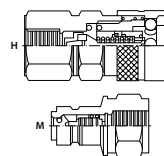

THREAD ROSCA	ISO SIZE TAMAÑO ISO	C. E.	Part n° Referencia	€
1/4" BSP	6.3	M	A920104	43,91
1/4" BSP	6.3	F	A920204	113,96

# Enchufes rápidos

Quick-release couplings  
Coupleurs rapides  
Innesti rapidi

## Válvula de frenado macho

Male brake valve

Valve freinage mâle

Valvola di frenaggio maschio

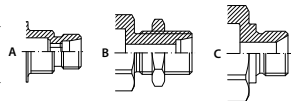

THREAD ROSCA		ISO SIZE TAMAÑO ISO	C. E.	Part n° Referencia	€
1/2" BSP	-	12.5	M (Type C)	<b>A910508</b>	<b>14,64</b>
M18X1,5	-	12.5	M (Type B)	<b>A912118</b>	<b>15,74</b>
M20X1,5	-	12.5	M (Type B)	<b>A912120</b>	<b>16,05</b>
M22X1,5	-	12.5	M (Type B)	<b>A912122</b>	<b>16,31</b>
M16x1,5	M20x1,5	12.5	M (Type A)	<b>A912316</b>	<b>16,47</b>
M18x1,5	M20x1,5	12.5	M (Type A)	<b>A912318</b>	<b>16,47</b>

## Válvula de frenado hembra

Female brake valve

Valve freinage femelle

Valvola di frenaggio femmina

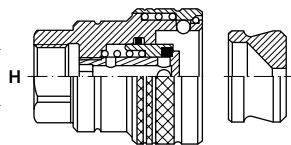

THREAD ROSCA	ISO SIZE TAMAÑO ISO	C. E.	Part n° Referencia	€
3/8" BSP	12.5	F	<b>A910206</b>	<b>29,17</b>
1/2" BSP	12.5	F	<b>A910208</b>	<b>28,54</b>
M18X1.5	12.5	F	<b>A910218</b>	<b>29,69</b>

## Válvula agrícola macho acoplamiento en presión

Male agricultural valve

Valve agricole à visser mâle

Valvola agricola maschio

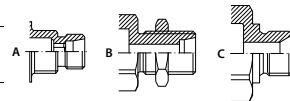

THREAD ROSCA		ISO SIZE TAMAÑO ISO	C. E.	Part n° Referencia	€
1/2" BSP	-	12.5	M (Type C)	<b>A950108</b>	<b>15,37</b>
M18x1,5	-	12.5	M (Type B)	<b>A950118</b>	<b>17,04</b>
M20x1,5	-	12.5	M (Type B)	<b>A950120</b>	<b>17,04</b>
M22x1,5	-	12.5	M (Type B)	<b>A950122</b>	<b>17,04</b>
M16x1,5	M20x1,5	12.5	M (Type A)	<b>A9141620</b>	<b>17,36</b>
M18x1,5	M20x1,5	12.5	M (Type A)	<b>A9141820</b>	<b>17,36</b>

## Válvula agrícola hembra acoplamiento en presión

Female agricultural valve

Valve agricole à visser femelle

Valvola agricola femmina

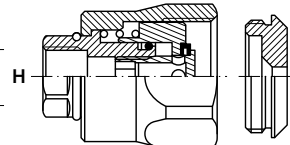

THREAD ROSCA	ISO SIZE TAMAÑO ISO	C. E.	Part n° Referencia	€
3/8" BSP	12.5	F	<b>A950206</b>	<b>25,82</b>
M18X1.5	12.5	F	<b>A950218</b>	<b>25,82</b>

## E.R. Punzón ISO B (rosca BSP) latón

ISO B Quick release coupling brass

Coupleur rapide à clapet norme ISO B laiton

Innesto rapido a valvola ISO B ottone

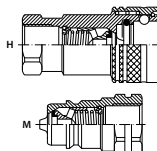

THREAD ROSCA	ISO SIZE TAMAÑO ISO	C. E.	Part n° Referencia	€
1/4" BSP	6.3	M	<b>A850104</b>	<b>11,50</b>
3/8" BSP	10	M	<b>A850106</b>	<b>14,64</b>
1/2" BSP	12.5	M	<b>A850108</b>	<b>20,39</b>
3/4" BSP	20	M	<b>A850112</b>	<b>36,59</b>
1" BSP	25	M	<b>A850116</b>	<b>65,87</b>
1"1/4 BSP	40	M	<b>A850120</b>	<b>365,93</b>
1"1/2 BSP	40	M	<b>A850124</b>	<b>365,93</b>
2" BSP	50	M	<b>A850132</b>	<b>857,31</b>
1/4" BSP	6.3	F	<b>A850204</b>	<b>29,27</b>
3/8" BSP	10	F	<b>A850206</b>	<b>41,82</b>
1/2" BSP	12.5	F	<b>A850208</b>	<b>67,96</b>
3/4" BSP	20	F	<b>A850212</b>	<b>117,62</b>
1" BSP	25	F	<b>A850216</b>	<b>174,08</b>
1"1/4 BSP	40	F	<b>A850220</b>	<b>480,93</b>
1"1/2 BSP	40	F	<b>A850224</b>	<b>480,93</b>
2" BSP	50	F	<b>A850232</b>	<b>1.343,47</b>



# Enchufes rápidos

Quick-release couplings  
Coupleurs rapides  
Innesti rapidi

Adaptors

OBS Accessories

Quick-release couplings

Ball valves, diverters and swivel fittings

Protections

## Tapones para enchufes rápidos ISO A

Plugs for ISO A quick release couplings

Bouchons et capuchons de plastique pour coupleurs norme ISO A

Tappi per ISO A



THREAD ROSCA	DESCRIPTION DESCRIPCIÓN	C. E.	Part nº Referencia	€
1/4"	Male plug for female coupling	F	A990104	1,78
3/8"	Male plug for female coupling	F	A990106	1,78
1/2"	Male plug for female coupling	F	A990108	1,46
3/4"	Male plug for female coupling	F	A990112	3,29
1"	Male plug for female coupling	F	A990116	5,49
1/4"	Cap for male coupling	M	A990204	1,78
3/8"	Cap for male coupling	M	A990206	1,78
1/2"	Cap for male coupling	M	A990208	1,46
3/4"	Cap for male coupling	M	A990212	3,29
1"	Cap for male coupling	M	A990216	5,49

## Tapones para enchufes ISO B

Caps and plugs for ISO B quick release coupling

Bouchons et capuchons de plastique pour coupleurs ISO B

Tappi per ISO B



DN	THREAD ROSCA	DESCRIPTION DESCRIPCIÓN	C. E.	Part nº Referencia	€
6	1/4"	Male plug for female coupling	F	A991104	2,80
10	3/8"	Male plug for female coupling	F	A991106	2,80
10	1/2"	Male plug for female coupling	F	A991108	3,07
20	3/4"	Male plug for female coupling	F	A991112	3,33
25	1"	Male plug for female coupling	F	A991116	4,66
6	1/4"	Cap for male coupling	M	A991204	2,80
13	3/8"	Cap for male coupling	M	A991206	2,80
13	1/2"	Cap for male coupling	M	A991208	3,07
20	3/4"	Cap for male coupling	M	A991212	3,33
25	1"	Cap for male coupling	M	A991216	4,66

## Tapones para enchufes de válvula plana

Plugs for flat face quick release couplings

Bouchons et capuchons de plastique pour coupleurs face plane

Tappi per innesti a faccia piana



DN	THREAD ROSCA	C. E.	Part nº Referencia	€
6	1/4"	F	A993104	3,50
10	3/8"	F	A993106	2,80
13	1/2"	F	A993108	2,80
20	3/4"	F	A993112	3,55
30	1"	F	A993116	13,33
6	1/4"	M	A993204	3,53
10	3/8"	M	A993206	2,80
13	1/2"	M	A993208	2,80
20	3/4"	M	A993212	3,55
30	1"	M	A993216	13,33

## Tapones para enchufes autorroscantes ISO 14541

Plug for quick release screw coupling ISO 14541

Bouchon pour coupleur rapide à visser ISO 14541

Tappi per innesti rapidi a vite ISO 14541



THREAD ROSCA	ISO SIZE TAMAÑO ISO	C. E.	Part nº Referencia	€
1/4"	6.3	F	A994104	5,23
3/8"	10	F	A994106	5,23
1/2"	12.5	F	A994108	4,71
3/4"	19	F	A994112	5,23
1"	25	F	A994116	5,23
1/4"	6.3	M	A994204	5,23
3/8"	10	M	A994206	5,23
1/2"	12.5	M	A994208	4,71
3/4"	19	M	A994212	5,23
1"	25	M	A994216	5,23

## Tapones para enchufes altísima presión

Plug for quick release coupling very high pressure

Bouchon pour coupleur rapide très haute pression

Tappi per innesti rapidi alti pressione



THREAD ROSCA	Part nº Referencia	€
3/8"	A992106	6,80

## Arandelas PTFE

PTFE seals

Rondelles PTFE

Rondelle a PTFE



THREAD ROSCA	Part nº Referencia	€
1/4" BSP	PTFEA04	0,73
3/8" BSP	PTFEA06	0,85
1/2" BSP	PTFEA08	0,92
3/4" BSP	PTFEA12	1,53
1" BSP	PTFEA16	1,53

## Juego de juntas de reparación e.r. ISO A

Kit of seals to repair for ISO A quick release coupling

Jeu de joints pour coupleur ISO A

Guarnizioni per innesto ISO A



THREAD ROSCA	Part nº Referencia	€
1/4" BSP	NBRA04	0,43
3/8" BSP	NBRA06	0,55
1/2" BSP	NBRA08	0,67
3/4" BSP	NBRA12	0,73
1" BSP	NBRA16	0,79

# Enchufes rápidos y llaves de paso TrΔle

TrΔle quick-release couplings and ball valves

Coupleurs rapides et robinets TrΔle

Innesti rapidi e rubinetti TrΔle

## E.R. Punzón ISO A

ISO A Quick release coupling

Coupleur rapide à clapet norme ISO A

Innesto rapido a valvola ISO A (BSP)

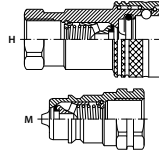

DN	THREAD ROSCA	C. E.	Part nº Referencia	€
6	1/4" BSP	M	B800104	4,27
10	3/8" BSP	M	B800106	4,88
13	1/2" BSP	M	B800108	5,67
20	3/4" BSP	M	B800112	9,33
25	1" BSP	M	B800116	15,85
6	1/4" BSP	F	B800204	9,15
10	3/8" BSP	F	B800206	10,67
13	1/2" BSP	F	B800208	13,17
20	3/4" BSP	F	B800212	21,83
25	1" BSP	F	B800216	37,56

## E.R. Punzón Serie NV

Quick release coupling NV serie

Coupleur rapide à clapet serie NV

Innesto rapido valvola Serie NV

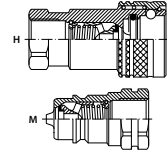

DN	THREAD ROSCA	C. E.	Part nº Referencia	€
6	1/4" BSP	M	B820104	4,57
10	3/8" BSP	M	B820106	5,24
20	3/4" BSP	M	B820112	10,00
25	1" BSP	M	B820116	15,79
6	1/4" BSP	F	B820204	9,82
6	3/8" BSP	F	B820206	11,40
20	3/4" BSP	F	B820212	23,35
25	1" BSP	F	B820216	36,76

1/2" IDEM ISO A (B800108/B800208) / 1/2" IDEM ISO A (B800108/B800208) / 1/2" IDEM ISO A (B800108/B800208) / 1/2" IDEM ISO A (B800108/B800208)

## E.R. Punzón ISO B

ISO B Quick release coupling

Coupleur rapide à clapet norme ISO B

Innesto rapido a valvola ISO B

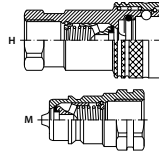

DN	THREAD ROSCA	C. E.	Part nº Referencia	€
6	1/4" BSP	M	B810104	4,69
10	3/8" BSP	M	B810106	5,37
13	1/2" BSP	M	B810108	6,22
20	3/4" BSP	M	B810112	10,30
25	1" BSP	M	B810116	16,22
6	1/4" BSP	F	B810204	10,06
10	3/8" BSP	F	B810206	11,77
13	1/2" BSP	F	B810208	14,51
20	3/4" BSP	F	B810212	24,02
25	1" BSP	F	B810216	37,80

## E.R. Punzón ISO A (rosca NPT)

ISO A quick release coupling NPT

Coupleur rapide à clapet ISO A NPT

Innesto rapido valvola ISO A NPT

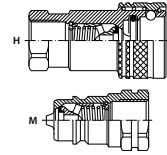

DN	THREAD ROSCA	C. E.	Part nº Referencia	€
6	1/4" NPT	M	B801104	4,27
10	3/8" NPT	M	B801106	4,88
13	1/2" NPT	M	B801108	5,67
20	3/4" NPT	M	B801112	9,33
25	1" NPT	M	B801116	15,85
6	1/4" NPT	F	B801204	9,15
10	3/8" NPT	F	B801206	10,67
13	1/2" NPT	F	B801208	13,17
20	3/4" NPT	F	B801212	21,83
25	1" NPT	F	B801216	37,56

## E.R. Válvula plana Ecológico

Ecological flat face coupling

Coupleur rapide à clapet face plane "Ecologique"

Innesto rapido a faccia piana Ecologico

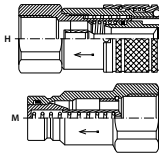

DN	THREAD ROSCA	C. E.	Part nº Referencia	€
6	1/4" BSP	M	B900104	9,81
13	3/8" BSP	M	B900106	14,63
20	1/2" BSP	M	B900108	21,95
25	3/4" BSP	M	B900112	26,83
25	1" BSP	M	B900116	41,28
6	1/4" BSP	F	B900204	25,55
13	3/8" BSP	F	B900206	34,14
20	1/2" BSP	F	B900208	45,12
25	3/4" BSP	F	B900212	62,49
25	1" BSP	F	B900216	96,39

## Válvulas de frenado

Brake valves

Valves freinage

Valvole di frenaggio

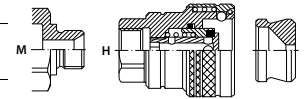

DN	THREAD ROSCA	C. E.	Part nº Referencia	€
13	1/2" BSP	M (TIPO C)	B910508	9,88
13	1/2" BSP	F	B910208	21,95

# Enchufes rápidos y llaves de paso TrΔle

TrΔle quick-release couplings and ball valves

Coupleurs rapides et robinets TrΔle

Innesti rapidi e rubinetti TrΔle

Adaptors

ORFS Accessories

Quick-release couplings

Ball valves, diverters and swivel fittings

Protections

## Llaves paso dos vías hembra BSP con agujeros

2 way ball valves BSP female with fixing holes

Robinet 2 voies boisseau sphérique BSP avec trous de fixation

Rubinetto a due vie con fori di fissaggio



DN	THREAD ROSCA	Part n° Referencia	€
6	1/4" BSP	GB2V 1/4	22,93
10	3/8" BSP	GB2V 3/8	25,95
13	1/2" BSP	GB2V 1/2	28,81
20	3/4" BSP	GB2V 3/4	47,55
25	1" BSP	GB2V 1	65,78

## Llave 2 vías rosca hembra NPT

2 Ways ball valve NPT female

Robinet haute pression 2 voies boisseau sphérique sortie femelle briggs (NPT)

Rubinetto a sfera 2 vie femmina NPT



DN	THREAD ROSCA	Part n° Referencia	€
6	1/4" NPT	GB2V 1/4 NPT	22,93
10	3/8" NPT	GB2V 3/8 NPT	27,99
13	1/2" NPT	GB2V 1/2 NPT	31,06
20	3/4" NPT	GB2V 3/4 NPT	47,55
25	1" NPT	GB2V 1 NPT	65,78

## Llave paso tres vías hembra-macho(60°)-hembra (tipo L)

3 way ball valves female-male(60°)-female (type L)

Robinets 3 voies fem.-mâle(60°)-fem. (type L)

Rubinetto a tre vie fem.-maschio(60°)-fem. (tipo L)



DN	THREAD ROSCA	Part n° Referencia	€
6	1/4" BSP	GB3V 1/4	73,04
10	3/8" BSP	GB3V 3/8	44,94
13	1/2" BSP	GB3V 1/2	52,26
20	3/4" BSP	GB3V 3/4	67,93
25	1" BSP	GB3V 1	99,35

Con agujeros de fijación / With mounting holes / Avec des trous de montage / Con fori di montaggio

## Llave 2 vías tubo rígido Serie Ligera

2 Ways ball valve: tube connection Serie Light

Robinet haute pression 2 voies boisseau sphérique sortie pour tube rigide DIN Série Légère

Rubinetto a sfera maschio DIN 2353 Serie L



DN	PIPE TUBO	THREAD ROSCA	Part n° Referencia	€
4	6L	M12x1.5	GB2V 6 L	22,87
6	8L	M14x1.5	GB2V 8 L	22,71
8	10L	M16x1.5	GB2V 10 L	22,71
10	12L	M18x1.5	GB2V 12 L	25,22
13	15L	M22x1.5	GB2V 15 L	28,33
13	18L	M26x1.5	GB2V 18 L	28,35
20	22L	M30x2	GB2V 22 L	54,74
25	28L	M36x2	GB2V 28 L	70,84

## Llave 2 vías tubo rígido Serie Pesada

2 Ways ball valve: tube connection Serie Heavy

Robinet haute pression 2 voies boisseau sphérique sortie pour tube rigide din Série Lourde

Rubinetto a sfera maschio DIN Serie S



DN	PIPE TUBO	THREAD ROSCA	Part n° Referencia	€
4	8S	M16x1.5	GB2V 8 S	28,34
6	10S	M18x1.5	GB2V 10 S	22,87
8	12S	M20x1.5	GB2V 12 S	22,87
13	16S	M24x1.5	GB2V 16 S	38,25
16	20S	M30x2	GB2V 20 S	45,85
20	25S	M36x2	GB2V 25 S	61,18
25	30S	M42x2	GB2V 30 S	70,84

## Llave paso tres vías hembra-hembra-hembra (tipo L)

3 way ball valves female-female-female (type L)

Robinets 3 voies fem.-fem.-fem. (type L)

Rubinetto a tre vie fem.-fem.-fem. (tipo L)



DN	THREAD ROSCA	Part n° Referencia	€
6	1/4" BSP	GB3VH 1/4	32,59
10	3/8" BSP	GB3VH 3/8	44,94
13	1/2" BSP	GB3VH 1/2	52,26
20	3/4" BSP	GB3VH 3/4	67,93
25	1" BSP	GB3VH 1	91,83

# Multienchufe

Multi-way coupling  
Multi-coupleur  
Multinesti

## Multienchufe 4 vías sin enchufes

Multi-way coupling 4 ways without connector

Multi-coupleur 4 voies sans connecteur

Piastra multi-innesti a 4 linee, senza innesti



DESCRIPTION DESCRIPCIÓN	WAYS NR. Nº VIAS	Part nº Referencia	€
--	4 ways	<b>MEC4S</b>	<b>230,40</b>
Electrical	4 ways	<b>MEC4SE</b>	*

Los Multienchufes eléctricos se suministrarán sin conector / The Multi-way electric couplings are supplied without connector / Les Multi-coupleurs électriques seront fournis sans connecteur / Le piastra multi-innesti elettriche sono fornite senza connettori

## Multienchufe 4 vías con enchufes

Multi-way coupling 4 ways with connector

Multi-coupleur 4 voies avec connecteur

Piastra multi-innesti a 4 linee, con innesti



DESCRIPTION DESCRIPCIÓN	C. E.	WAYS NR. Nº VIAS	Part nº Referencia	€
--	2 x F 1/2" BSP	4 ways	<b>MEC42H08</b>	*
-	2 x M 1/2" BSP	4 ways	<b>MEC42M08</b>	*
-	4 x F 1/2" BSP	4 ways	<b>MEC44H08</b>	<b>574,41</b>
-	4 x M 1/2" BSP	4 ways	<b>MEC44M08</b>	<b>574,52</b>
Electrical	4 x M 1/2" BSP	4 ways	<b>MEC44M08E</b>	*
Electrical	4 x F 1/2" BSP	4 ways	<b>MEC44H08E</b>	*
Electrical	2 x M 1/2" BSP	4 ways	<b>MEC42M08E</b>	*
Electrical	2 x F 1/2" BSP	4 ways	<b>MEC42H08E</b>	*

Los Multienchufes eléctricos se suministrarán sin conector / The Multi-way electric couplings are supplied without connector / Les Multi-coupleurs électriques seront fournis sans connecteur / Le piastra multi-innesti elettriche sono fornite senza connettori

## Multienchufe 2 vías sin enchufes

Multi-way coupling 2 ways without connector

Multi-coupleur 2 voies sans connecteur

Piastra multi-innesti a 2 linee, senza innesti



DESCRIPTION DESCRIPCIÓN	C. E.	WAYS NR. Nº VIAS	Part nº Referencia	€
-	-	2 ways	<b>MEC2S</b>	<b>176,82</b>
Electrical	-	2 ways	<b>MEC2SE</b>	*

Los Multienchufes eléctricos se suministrarán sin conector / The Multi-way electric couplings are supplied without connector / Les Multi-coupleurs électriques seront fournis sans connecteur / Le piastra multi-innesti elettriche sono fornite senza connettori

## Multienchufe 2 vías con enchufes

Multi-way coupling 2 ways with connector

Multi-coupleur 2 voies avec connecteur

Piastra multi-innesti a 2 linee, con innesti



DESCRIPTION DESCRIPCIÓN	C. E.	WAYS NR. Nº VIAS	Part nº Referencia	€
-	2 x F 1/2" BSP	2 ways	<b>MEC22H08</b>	<b>349,50</b>
-	2 x M 1/2" BSP	2 ways	<b>MEC22M08</b>	<b>349,50</b>
Electrical	2 x F 1/2" BSP	2 ways	<b>MEC22H08E</b>	*
Eléctrico	2 x M 1/2" BSP	2 ways	<b>MEC22M08E</b>	*

Los Multienchufes eléctricos se suministrarán sin conector / The Multi-way electric couplings are supplied without connector / Les Multi-coupleurs électriques seront fournis sans connecteur / Le piastra multi-innesti elettriche sono fornite senza connettori

## Enchufes rápidos

Quick-release couplings

Coupleurs rapides

Innesti rapidii



THREAD ROSCA	C. E.	Part nº Referencia	€
F 1/2" BSP	M	<b>A930108</b>	*
F 1/2" BSP	F	<b>A930208</b>	*
M 1/2" BSP	M	<b>A940108</b>	*
M 1/2" BSP	F	<b>A940208</b>	*

## Repuestos

Spare parts

Pièces de rechange

Pezzi di ricambio



DESCRIPTION DESCRIPCIÓN	Part nº Referencia	€
Cover Kit	<b>MEC4TP</b>	<b>80,37</b>
Electrical Cover Kit	<b>MEC4TPEL</b>	<b>96,45</b>
Support plate 4 ways	<b>MEC4CS</b>	<b>10,18</b>
Operating kit multi-coupling	<b>MEC4ACC</b>	<b>52,53</b>
Closing Kit	<b>MEC4SG</b>	<b>9,82</b>

# Multienchufe

Multiway couplings  
Multi-coupleurs  
Multinnesti 4 vie

## ■ Características / Characteristics / Caractéristiques / Caratteristiche

**"Fugas Cero" enchufes ecológicos de caras planas**

**Se pueden acoplar y desacoplar en presión**

**Cómoda apertura y cierre**

**Fácil mantenimiento y limpieza**

**Como opción se puede suministrar con acoplamiento eléctrico integrado**

*"No leaks" flat face "Ecological" quick couplings*

*They can be coupled and uncoupled within pressure*

*Handy opening and closing*

*Easy to maintain and to clean*

*Option: they could be supplied with an electric coupling integrated*

Pas de fuites: coupleurs écologiques face plane

Ils peuvent s'accoupler / desaccoupler en pression

Ouverture / fermeture facile

Entretien / maintenance facile

En option peut être fourni avec accouplement électrique intégré

*"Zero perdita", innesto rapido ecologico faccia piana*

*Innestabile e disinnestabile in pressione*

*Comoda apertura e chiusura*

*Facile manutenzione e pulizia*

*Opzione: Possibile fornitura con accoppiamento elettrico integrato*



## ■ Disponibles con roscas hembra BSP-1/2 o macho BSP-1/2. Se suministran con 2 ó 4 enchufes

Available with thread female BSP 1/2 or male BSP 1/2.

They are supplied with 2 or 4 couplings

Disponibles avec filetages femelle BSP-1/2 ou mâle BSP-1/2. Ils sont livrés avec 2 ou 4 coupleurs

Disponibili con filetti femina BSP 1/2 o maschio BSP 1/2, sono fornibili con 2 o 4 innesti



## ■ Accesorios

Accessories  
Accessoires  
Accessori

### ■ Tapa de protección

Protection cap  
Couvercle de protection  
Tappo di protezione



### ■ Chapa de sujeción

Subjection plate  
Plaque de fixation  
Piastra di sicurezza



### ■ Enchufes repuesto

Spare couplings  
Coupleurs de réchange  
Innesti di ricambio



Referencia Part No. Référence Codice	Descripción Description Descriptione Descrizione
MEC44H08	<b>Multienchufe 4 rosca hembra BSP / Multi quick coupling 4 thread female BSP</b> Multicoupleur 4 filetage femelle BSP / Multinnesto 4 filetto femina BSP
MEC42H08	<b>Multienchufe 2 rosca hembra BSP / Multi quick coupling 2 thread female BSP</b> Multicoupleur 2 filetage femelle BSP / Multinnesto 2 filetto femina BSP
MEC44M08	<b>Multienchufe 4 rosca macho BSP / Multi quick coupling 4 thread male BSP</b> Multicoupleur 4 filetage mâle BSP / Multinnesto 4 filetto maschio BSP
MEC42M08	<b>Multienchufe 2 rosca macho BSP / Multi quick coupling 2 thread male BSP</b> Multicoupleur 2 filetage mâle BSP / Multinnesto 2 filetto maschio BSP

## ■ Accesorios / Accessories / Accessoires / Accessori

Referencia Part No. Référence Codice	Descripción Description Descriptione Descrizione
MEC4TP	<b>Tapa de protección multienchufes 4 vías / 4 ways multi quick coupling protection cap</b> Couvercle de protection multi-coupleurs 4 voies / Tappo di protezione per multinnesti 4 vie
MEC4CS	<b>Chapa de sujeción multienchufes / Multi quick couplings subjection plate</b> Tape de fixation multi-coupleurs / Piastra di sicurezza per multinnesti 4 vie

## ■ Repuestos / Spare parts / Pieces de réchange / Ricambi

Referencia Part No. Référence Codice	Descripción Description Descriptione Descrizione
A930108	<b>Enchufe macho - rosca hembra 1/2 / Male quick coupling - female thread 1/2</b> Coupleur mâle - filetage femelle 1/2 / Innesto maschio - filetto femina 1/2
A930208	<b>Enchufe hembra - rosca hembra 1/2 / Female quick coupling - female thread 1/2</b> Coupleur femelle - filetage femelle 1/2 / Innesto femina - filetto femina 1/2
A940108	<b>Enchufe macho - rosca macho 1/2 / Male quick coupling - male thread 1/2</b> Coupleur mâle - filetage mâle 1/2 / Innesto maschio - filetto maschio 1/2
A940208	<b>Enchufe hembra - rosca macho 1/2 / Male quick coupling - female thread 1/2</b> Coupleur mâle - filetage femelle 1/2 / Innesto femina - filetto maschio 1/2

# Multienchufe

Multi-way coupling  
Multi-coupleur  
Multinesti

## Multienchufe completo nuevo diseño

Complete multi-way coupling new design

Multi-coupleur complet nouveau design

Multinesti nuovo design



DESCRIPTION DESCRIPCIÓN	C. E.	WAYS NR. Nº VIAS	Part nº Referencia	€
-	2 x F 1/2" BSP	2 ways	<b>MEN22H08</b>	<b>528,50</b>
--	4 x F 1/2" BSP	4 ways	<b>MEN44H08</b>	<b>706,00</b>



**MULTIENCHUFE COMPLETO**  
nuevo diseño

**COMPLETE MULTI-WAY COUPLING**  
new design

**MULTI-COUPLEUR COMPLET**  
nouveau design

**DOS MODELOS A ELEGIR**  
2 o 4 vias

**CHOOSE YOUR TYPE**  
2 or 4 ways

**DEUX MODÈLES A CHOISIR**  
2 ou 4 voies

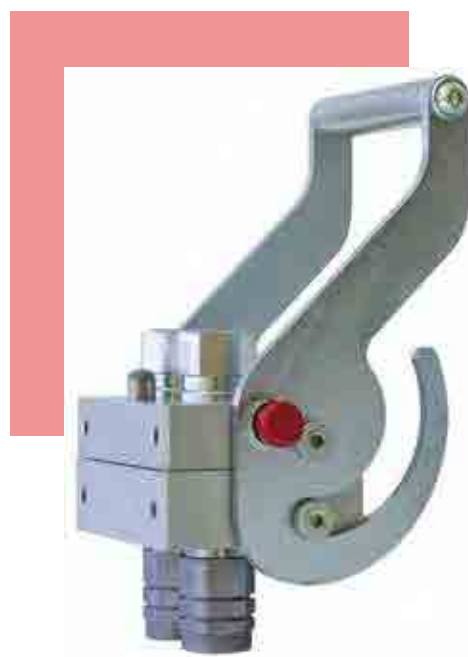

# DESCARGA FICHAS TÉCNICAS · DOWNLOAD TECHNICAL DATAS

www.dicsaes.com

Selecciona un producto de nuestro catálogo de productos  
*Select a product from our product catalog*



Haz clic en "Documentación técnica" debajo de la tabla  
*Click on "Technical Documentation" under the table*



También puedes hacer clic en una referencia de la tabla  
*You can also click on any reference of a table*



Haz clic en "Documentación técnica"  
*Click on "Technical Documentation"*

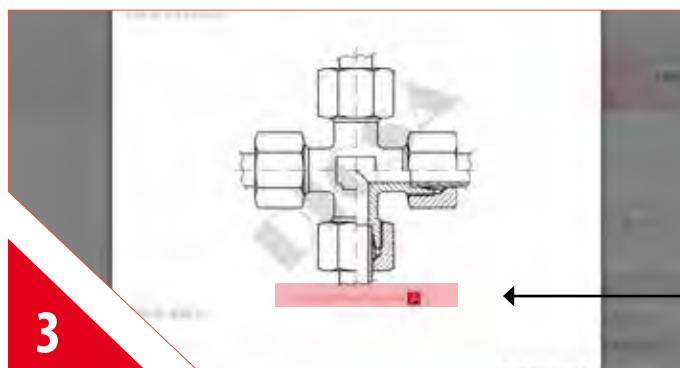

Se abrirá un archivo PDF con los datos técnicos que podrá guardar en su ordenador.  
*A PDF file will appear with the technical data, which can be saved in your computer.*

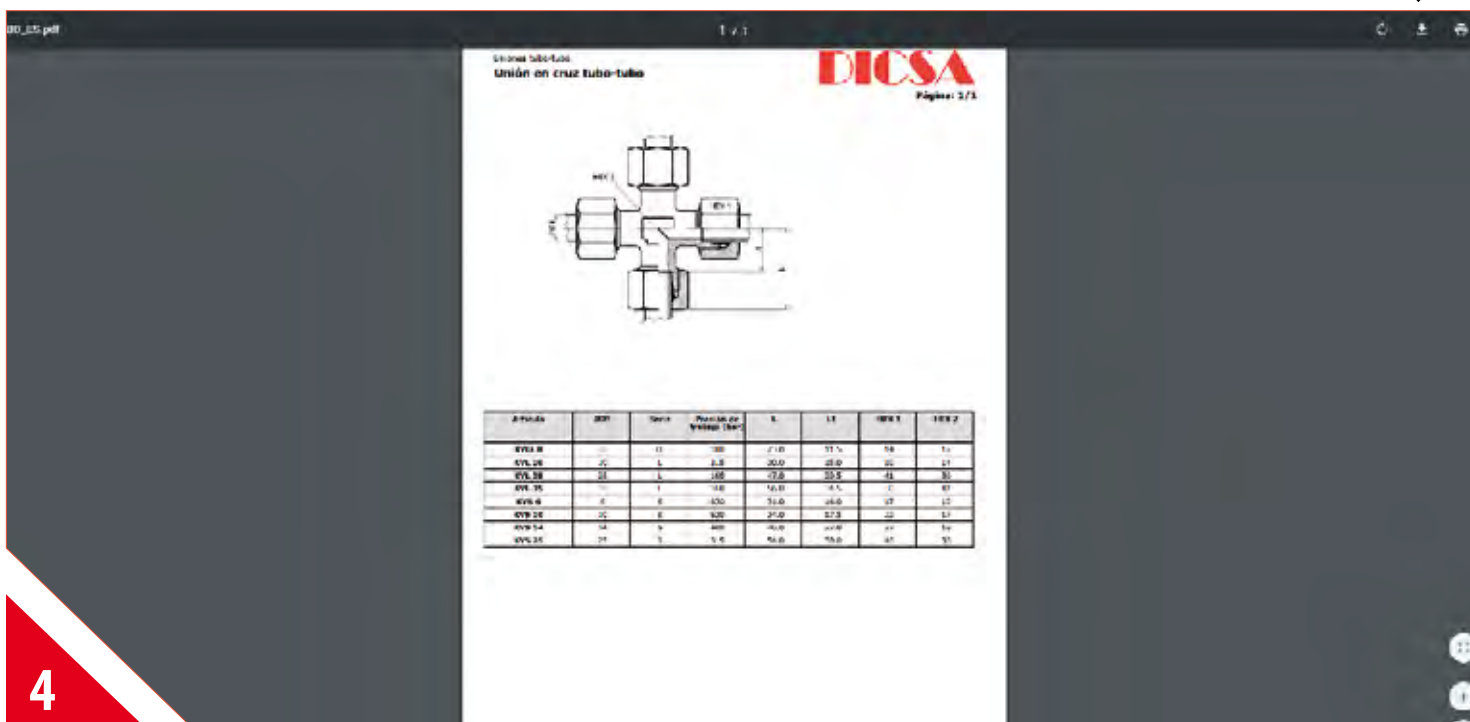

## Llaves paso, desviadores y racores giratorios

*Ball valves, diverters and swivel fittings*

Robinets, déviateurs et raccords tournants

*Rubinetti, deviatori, raccordi girevoli*

### Llaves de paso

*Ball valves*

Robinets

*Rubinetti a sfera*

308

### Desviadores

*Diverters*

Déviateurs

*Deviatori di flusso*

312

### Racores giratorios

*Swivel fittings*

Raccords tournants

*Raccordi girevoli*

313



4

# Llaves de paso

Ball valves  
Robinets  
Rubinetti a sfera

## De 2 vías / 2 Ways ball valve / Robinets haute pression 2 voies / Rubinetti a sfera 2 vie

| 308



BKH G

BKH L

BKH S

BKH G NPT

BKH L DN

BKH S DN

BKH G DN

## De 3 vías / 3 Ways ball valve / Robinets haute pression 3 voies / Rubinetti a sfera 3 vie

| 309



BK3 G

3KH G

BK3 GT

BK3 NPT

A600

## De 4 vías / 4 Ways ball valve / Robinets haute pression 4 voies / Rubinetti a sfera 4 vie

| 309



4KH G

## Útiles para cierre con candado / Locking devices / Dispositifs de verrouillage / Dispositivos di bloccaggio

| 310



CANDT2

CANDT4

## Llaves de baja presión / Ball valves low pressure / Robinets basse pression / Rubinetti a sfera bassa pressione

| 310



BP2V

BP2VA

## Desviadores

*Diverters*  
*Déviateurs*  
*Deviatori di flusso*

### ■ Desviadores manuales / Manual diverters / Déviateurs manuels / Deviatori di flusso manuali

| 312



D3V

D4V

D6V

## Racores giratorios

*Swivel fittings*  
*Raccords tournants*  
*Raccordi girevoli*

### ■ Racores giratorios / Swivel fittings / Raccords tournants / Raccordi girevoli

| 313



GGL

GG90

GGL\_NPT

GG90\_NPT

# Llaves de paso

Ball valves  
Robinets  
Rubinetti a sfera

## Llave 2 vías rosca hembra BSP con agujeros

2 Ways ball valve BSP female with holes

Robinet haute pression 2 voies boisseau sphérique BSP avec trous de fixation

Rubinetto a sfera femmina-femmina BSP



DN	THREAD ROSCA	Part n° Referencia	€
4	1/8" BSP	BKH G 1/8	40,06
6	1/4" BSP	BKH G 1/4	29,41
10	3/8" BSP	BKH G 3/8	27,33
13	1/2" BSP	BKH G 1/2	31,00
20	3/4" BSP	BKH G 3/4	63,68
25	1" BSP	BKH G 1	72,20
25	1"1/4 BSP	BKH G 1 1/4 DN25	77,36
25	1"1/2 BSP	BKH G 1 1/2 DN25	137,87

## Llave 2 vías tubo rígido Serie Ligera

2 Ways ball valve: tube connection Serie Light

Robinet haute pression 2 voies boisseau sphérique sortie pour tube rigide DIN Série Légère

Rubinetto a sfera maschio DIN 2353 Serie L



DN	PIPE TUBO	THREAD ROSCA	Part n° Referencia	€
4	6L	M12x1.5	BKH 6 L	37,42
6	8L	M14x1.5	BKH 8 L	28,65
8	10L	M16x1.5	BKH 10 L	29,79
10	12L	M18x1.5	BKH 12 L	34,10
13	15L	M22x1.5	BKH 15 L	33,68
16	18L	M26x1.5	BKH 18 L	45,04
20	22L	M30x2	BKH 22 L	74,90
25	28L	M36x2	BKH 28 L	120,05
25/32	35L	M45X2	BKH 35 L	125,69
25/40	42L	M52x2	BKH 42 L	202,94

## Llave 2 vías tubo rígido Serie Pesada

2 Ways ball valve: tube connection Serie Heavy

Robinet haute pression 2 voies boisseau sphérique sortie pour tube rigide din Série Lourde

Rubinetto a sfera maschio DIN Serie S



DN	PIPE TUBO	THREAD ROSCA	Part n° Referencia	€
4	8S	M16x1.5	BKH 8 S	41,55
6	10S	M18x1.5	BKH 10 S	34,78
8	12S	M20x1.5	BKH 12 S	31,75
10	14S	M22x1.5	BKH 14 S	54,95
13	16S	M24x1.5	BKH 16 S	39,54
16	20S	M30x2	BKH 20 S	88,60
13	20S	M30x2	BKH 20 S DN13	53,01
20	25S	M36x2	BKH 25 S	82,52
25	30S	M42x2	BKH 30 S	115,75

## Llave 2 vías rosca hembra NPT

2 Ways ball valve NPT female

Robinet haute pression 2 voies boisseau sphérique sortie femelle briggs (NPT)

Rubinetto a sfera 2 vie femmina NPT



DN	THREAD ROSCA	Part n° Referencia	€
6	1/4" NPT	BKH G 1/4 NPT	44,75
10	3/8" NPT	BKH G 3/8 NPT	51,86
13	1/2" NPT	BKH G 1/2 NPT	56,10
20	3/4" NPT	BKH G 3/4 NPT	98,73
25	1" NPT	BKH G 1 NPT	127,56
32	1"1/4 NPT	BKH G 1 1/4 NPT	170,31
40	1"1/2 NPT	BKH G 1 1/2 NPT	223,70
50	2" NPT	BKH G 2 NPT	453,02

## Llave 2 vías tubo rígido L paso total

Ball-valves: tube connection L serie DIN 2353 full bore

Robinets haute pression 2 voies boisseau sphérique femelle ISO 228

Rubinetto a sfera maschio DIN 2353 -L-



DN	PIPE TUBO	THREAD ROSCA	Part n° Referencia	€
32	35L	M45X2	BKH 35 L DN32	306,46
40	40L	M52x2	BKH 42 L DN40	404,79

## Llave 2 vías tubo rígido S paso total

Ball-valves: tube connection S serie DIN 2353 full bore

Robinets haute pression 2 voies boisseau sphérique métrique Série Lourde passage total

Rubinetto a sfera maschio DIN 2353 -S-



DN	PIPE TUBO	THREAD ROSCA	Part n° Referencia	€
32	38S	M52x2	BKH 38 S DN32	310,93

## Llave de paso BSP hembra ISO 228 paso total

Ball-valves BSP female ISO 228

Robinets haute pression 2 voies boisseau sphérique femelle ISO 228

Rubinetto a sfera femmina BSP ISO228



DN	THREAD ROSCA	Part n° Referencia	€
32	1"1/4 BSP	BKH G 1 1/4 DN32	303,82
40	1"1/2 BSP	BKH G 1 1/2 DN40	351,67
50	2" BSP	BKH G 2 DN50	456,71

# Llaves de paso

Ball valves  
Robinets  
Rubinetti a sfera

## Llave 3 vías hembra-hembra-hembra BSP (Tipo L)

3 Ways ball valve BSP female-female-female (Type L)

Robinet haute pression 3 voies série "L" boisseau sphérique femelle-femelle-femelle BSP

Rubinetti a sfera 3 vie femmina (Tipo L)



DN	THREAD ROSCA	Part nº Referencia	€
6	1/4" BSP	BK3 G 1/4	71,69
10	3/8" BSP	BK3 G 3/8	71,69
13	1/2" BSP	BK3 G 1/2	83,61
20	3/4" BSP	BK3 G 3/4	164,61
25	1" BSP	BK3 G 1	226,03

La entrada del caudal es solamente por la vía central. / The input flow is only through the central way. / L'entrée du débit est seulement par la voie centrale. / L'ingresso al flusso è solo la linea centrale

## Llave 3 vías hembra-multivía (Tipo L)

Multi-way ball valves female 3 ways (Type L)

Robinet haute pression 3 voies série "L" boisseau sphérique femelle gaz

Rubinetti a sfera 3 vie femmina (Tipo L)



DN	THREAD ROSCA	Part nº Referencia	€
4	1/8" BSP	3KH G 1/8	409,21
6	1/4" BSP	3KH G 1/4	317,63
10	3/8" BSP	3KH G 3/8	358,49
13	1/2" BSP	3KH G 1/2	460,84
20	3/4" BSP	3KH G 3/4	791,02
25	1" BSP	3KH G 1	828,21
25/32	1"1/4 BSP	3KH G 1 1/4	900,81
25/40	1"1/2 BSP	3KH G 1 1/2	925,80

La entrada del caudal puede ser por cualquiera de las 3 vías. / The input flow can be done through any of the 3 ways. / L'entrée du débit peut être par l'un des 3 voies. / Il flusso in ingresso può essere da qualsiasi dei 3 vie.

## Llave 4 vías rosca hembra BSP (Tipo X)

Multi-way ball valves female 4 ways (Type X)

Robinet haute pression 4 voies série "X" boisseau sphérique femelle gaz

Rubinetti 4 vie femmina BSP (Tipo X)



DN	THREAD ROSCA	Part nº Referencia	€
4	1/8" BSP	4KH G 1/8	384,22
6	1/4" BSP	4KH G 1/4	443,53
10	3/8" BSP	4KH G 3/8	363,88
13	1/2" BSP	4KH G 1/2	433,22
20	3/4" BSP	4KH G 3/4	768,04
25	1" BSP	4KH G 1	911,13
25/32	1"1/4 BSP	4KH G 1 1/4	1.020,00
25/40	1"1/2 BSP	4KH G 1 1/2	1.071,58

## Llave 3 vías hembra-hembra-hembra BSP (Tipo T)

3 Ways ball valve BSP female-female-female (Type T)

Robinet haute pression 3 voies série "T" boisseau sphérique femelle-femelle-femelle BSP

Rubinetti a sfera 3 vie femmina (Tipo T)



DN	THREAD ROSCA	Part nº Referencia	€
6	1/4" BSP	BK3 G 1/4 T	71,69
10	3/8" BSP	BK3 G 3/8 T	71,69
13	1/2" BSP	BK3 G 1/2 T	83,61
20	3/4" BSP	BK3 G 3/4 T	164,61
25	1" BSP	BK3 G 1 T	226,03

La entrada del caudal es solamente por la vía central. / The input flow is only through the central way. / L'entrée du débit est seulement par la voie centrale. / L'ingresso al flusso è solo la linea centrale

## Llave 3 vías hembra-hembra-hembra NPT (Tipo L)

3 Ways ball valve NPT female-female-female (Type L)

Robinet haute pression 3 voies série "L" boisseau sphérique femelle-femelle-femelle NPT

Rubinetti a sfera 3 vie NPT femmina (Tipo L)



DN	THREAD ROSCA	Part nº Referencia	€
6	1/4" NPT	BK3 1/4 NPT	104,07
6	3/8" NPT	BK3 3/8 NPT	108,66
6	1/2" NPT	BK3 1/2 NPT	89,25
6	3/4" NPT	BK3 3/4 NPT	180,67
6	1" NPT	BK3 1 NPT	249,00

## Llaves especiales 3 vías macho-macho-macho (Tipo L)

Special 3 way valves male-male-male (Type L)

Robinets spéciaux 3 voies série "L" mâle-mâle-mâle

Rubinetti speciali 3 vie maschio-maschio-maschio



THREAD ROSCA	DESCRIPTION DESCRIPCIÓN	Part nº Referencia	€
1/2" BSP	3 Ways	A60030810	258,35

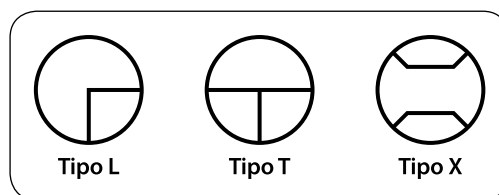

# Llaves de paso

Ball valves  
Robinets  
Rubinetti a sfera

## Útil para cierre con candado tipo 2

Locking devices type 2

Dispositifs de verrouillage type 2

Dispositivos di blocaggio tipo 2



DESCRIPTION DESCRIPCIÓN	Part n° Referencia	€
For ball valves: hex.9, DN4-8	<b>CANDT2-9A</b>	<b>33,18</b>
For ball valves: hex.9, DN10-13	<b>CANDT2-9B</b>	<b>33,18</b>
For ball valves: hex.14, DN20-25	<b>CANDT2-14</b>	<b>57,36</b>

## Útil para cierre con candado tipo 4

Locking devices type 4

Dispositifs de verrouillage type 4

Dispositivos di blocaggio tipo 4



DESCRIPTION DESCRIPCIÓN	Part n° Referencia	€
For ball valves: hex.9	<b>CANDT4-9</b>	<b>41,77</b>
For ball valves: hex.14	<b>CANDT4-14</b>	<b>54,60</b>

## Llave de esfera paso total baja presión

2 Ways ball valve low pressure

Robinet basse pression 2 voies boisseau  
sphérique passage total pn 16/25

Rubinettio a sfera bassa pressione passaggio  
totale



PIPE TUBO	THREAD ROSCA	Part n° Referencia	€
10	1/4" BSP	<b>BP2V14</b>	<b>7,79</b>
10	3/8" BSP	<b>BP2V38</b>	<b>7,79</b>
15	1/2" BSP	<b>BP2V12</b>	<b>6,50</b>
20	3/4" BSP	<b>BP2V34</b>	<b>9,26</b>
25	1" BSP	<b>BP2V1</b>	<b>14,98</b>
32	1"1/4 BSP	<b>BP2V114</b>	<b>22,94</b>
40	1"1/2 BSP	<b>BP2V112</b>	<b>33,92</b>
50	2" BSP	<b>BP2V2</b>	<b>49,94</b>
74	3" BSP	<b>BP2V3</b>	<b>166,67</b>
92	4" BSP	<b>BP2V4</b>	<b>270,35</b>

## Llave de esfera paso total baja presión anti-hielo

2 Ways ball valve low pressure non frozen

Robinet basse pression 2 voies boisseau  
sphérique passage total pn 25 anti-gel

Rubinettio a sfera, passaggio totale, anti-gelo



PIPE TUBO	THREAD ROSCA	Part n° Referencia	€
10	1/4" BSP	<b>BP2VA14</b>	<b>6,45</b>
10	3/8" BSP	<b>BP2VA38</b>	<b>6,45</b>
14,5	1/2" BSP	<b>BP2VA12</b>	<b>9,05</b>
19	3/4" BSP	<b>BP2VA34</b>	<b>13,06</b>
24	1" BSP	<b>BP2VA1</b>	<b>19,87</b>
30	1"1/4 BSP	<b>BP2VA114</b>	<b>33,40</b>
37	1"1/2 BSP	<b>BP2VA112</b>	<b>47,96</b>
47	2" BSP	<b>BP2VA2</b>	<b>76,31</b>
59	2"1/2 BSP	<b>BP2VA212</b>	<b>146,12</b>
70	3" BSP	<b>BP2VA3</b>	<b>226,34</b>
85,5	4" BSP	<b>BP2VA4</b>	<b>333,24</b>

# Ilaves de paso

Ball valves  
Robinets  
Rubinetti a sfera

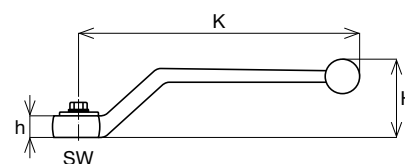

## Manetas

Handles for ball-valves  
Leviers pour robinets  
Maniglia

Para llaves de paso For ball-valves Pour robinets Per rubinetti a sfera	SW	Standard zinc Standard zinc Standard zinc Standard zinco		Acero Steel Acier Acciaio		INOX/SS316L	
		Referencia Part no. Référence Codice	€	Referencia Part no. Référence Codice	€	Referencia Part no. Référence Codice	€
Serie BSP 1/8 - 1/4 - 3/8 - 1/2 - 5/8	9	A60013155330	*	C600063	*	Z60013155330	*
Serie DIN 6 - 8 - 10 - 12 - 14 - 15 - 16 - 18	14	-	*	C708618	*	Z60013155331	*
Serie BSP 3/4 - 1 - 1 1/4		-	*	-	*	Z60013155332	*
Serie DIN 22 - 25 - 28 - 30 - 35 - 38	17	-	*	-	*	-	*
Serie BSP 1 1/4 - 1 1/2 - 2		-	*	-	*	-	*
Serie DIN 35 - 38 - 42	-	-	-	-	-	-	-

## Solo se suministra en aluminio

Only supplied in aluminium  
Seulement disponible en aluminium  
Disponibile solo in alluminio

Para llaves de paso For ball-valves Pour robinets Per rubinetti a sfera	SW	Referencia Part no. Référence Codice	€
Serie BSP 5/8	12	L501741	*
Serie DIN 15 - 16 - 18			

## Manetas

Handles for ball-valves  
Leviers pour robinets  
Maniglia

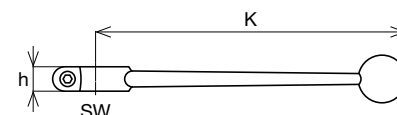

Para llaves de paso For ball-valves Pour robinets Per rubinetti a sfera	SW	Zinc Zinc Zinc Zinco		Aluminio Aluminium Aluminium Alluminio	
		Referencia Part no. Référence Codice	€	Referencia Part no. Référence Codice	€
Serie BSP 1/8 - 1/4 - 3/8 - 1/2 - 5/8	9	AR603722	*	-	*
Serie DIN 6 - 8 - 10 - 12 - 14 - 15 - 16 - 18	14	A60013155331	*	LR606745	*
Serie BSP 3/4 - 1 - 1 1/4					
Serie DIN 22 - 25 - 28 - 30 - 35 - 38	17	-	*	LR801799	*
Serie BSP 1 1/4 - 1 1/2 - 2					
Serie DIN 35 - 38 - 42	-	-	-	-	-

# Desviadores

Diverters  
Déviateurs  
Deviatori di flusso

## Desviador de 3 vías rosca hembra BSP

3 Way diverter BSP female

Déviateur manuel 3 voies femelle BSP

Deviatore di flusso 3 vie femmina



DN	THREAD ROSCA	Part nº Referencia	€
10	3/8" BSP	<b>D3V38</b>	<b>62,32</b>
13	1/2" BSP	<b>D3V12</b>	<b>71,00</b>
20	3/4" BSP	<b>D3V34</b>	<b>82,79</b>
25	1" BSP	<b>D3V10</b>	<b>103,02</b>

## Desviador de 4 vías

4 Way diverter BSP female

Déviateur manuel 4 voies femelle BSP

Deviatore di flusso 4 vie femmina



THREAD ROSCA	Part nº Referencia	€
1/2" BSP	<b>D4V12</b>	<b>89,54</b>
3/8" BSP	<b>D4V38</b>	<b>78,86</b>

## Desviador de 6 vías

6 Way diverter BSP female

Déviateur manuel 6 voies femelle BSP

Deviatore di flusso 6 vie femmina



DN	THREAD ROSCA	Part nº Referencia	€
10	3/8" BSP	<b>D6V38</b>	<b>142,57</b>
13	1/2" BSP	<b>D6V12</b>	<b>158,01</b>



# Racores giratorios

Swivel fittings  
Raccords tournants  
Raccordi girevoli

## Racor giratorio recto BSP

*Straight swivel fittings BSP*

Raccord tournant droit BSP

*Raccordo girevole BSP*



THREAD ROSCA	Part n° Referencia	€
1/4" BSP	GGL 1/4	22,23
3/8" BSP	GGL 3/8	23,86
1/2" BSP	GGL 1/2	27,85
3/4" BSP	GGL 3/4	45,43
1" BSP	GGL 1	60,17
1"1/4 BSP	GGL 1 1/4	98,15
1"1/2 BSP	GGL 1 1/2	149,43
2" BSP	GGL 2	242,71

## Racor giratorio 90° BSP

*Elbow 90° swivel fitting BSP*

Raccord tournant coude 90° BSP

*Raccordo girevole a 90° BSP*



THREAD ROSCA	Part n° Referencia	€
1/4" BSP	GG90 1/4	24,98
3/8" BSP	GG90 3/8	27,80
1/2" BSP	GG90 1/2	33,35
3/4" BSP	GG90 3/4	57,43
1" BSP	GG90 1	76,13
1"1/4 BSP	GG90 1 1/4	149,70
1"1/2 BSP	GG90 1 1/2	228,06
2" BSP	GG90 2	320,06

## Racor giratorio recto NPT

*Straight swivel fittings NPT*

Raccord tournant droit NPT

*Raccordo girevole NPT*



THREAD ROSCA	Part n° Referencia	€
1/4" NPT	GGL 1/4 NPT	24,46
3/8" NPT	GGL 3/8 NPT	26,24
1/2" NPT	GGL 1/2 NPT	30,57
3/4" NPT	GGL 3/4 NPT	51,77
1" NPT	GGL 1 NPT	66,19

## Racor giratorio 90° NPT

*Elbow 90° swivel fitting NPT*

Raccord tournant coude 90° NPT

*Raccordo girevole a 90° NPT*



THREAD ROSCA	Part n° Referencia	€
1/4" NPT	GG90 1/4 NPT	27,46
3/8" NPT	GG90 3/8 NPT	30,55
1/2" NPT	GG90 1/2 NPT	36,65
3/4" NPT	GG90 3/4 NPT	66,68
1" NPT	GG90 1 NPT	83,77

## Protecciones

*Protections*

Protections/ressorts

*Protezioni*

### Tapones de plástico

*Plastic plugs*

Capuchons plastique

*Tappi di plastica*

319

### Muelles

*Springs*

Ressorts

*Molle*

322

### Protecciones textiles

*Textile protection*

Protection textile

*Protezioni tessili*

324

### Fijaciones de seguridad

*Safety fixation*

Système de sécurité anti-fouet

*Fune di sicurezza*

327

5

## Tapones de plástico

Plastic plugs  
Capuchons plastique  
Tappi di plastica

### ■ Tapones hembra para roscas macho / Female plugs for male thread / Capuchons plastique femelle pour filetage mâle / Tappi femmina per filettature maschio

| 319



TFG

TFM

TFU

### ■ Tapones para bridas / Plugs for flanges / Capuchons plastique de brides SAE / Tappi per flangia

| 319



TS 3000

TS 6000

### ■ Tapones macho para roscas hembra / Male plugs for female thread / Bouchons plastique mâle pour filetage femelle / Tappi maschio per filettature femmina

| 320



TMG

TMM

TMU

### ■ Cinta PTFE / PTFE Tape / Ruban PTFE / Nastro di PTFE

| 320



M29990

### ■ Tapones para latiguillos / Plugs for hoses / Capuchons pour tuyau / Tappi per tubi

| 321



LHT

## Muelles

Springs  
Ressorts  
Molle

### ■ Muelles de plástico / Plastic springs / Ressorts plastique / Molla di plastica

| 322



AMUELLE P

AMUELLE P

AMUELLE P

# Muelles

Springs  
Ressorts  
Molle

- 
- **Muelles de plástico flexible** / *Flexible plastic springs* / *Ressorts plastique flexible* / *Molla di plastica flessibile*

| 322



- 
- **Muelles metálicos** / *Metallic springs* / *Ressorts métalliques* / *Molla metallica*

| 323



AMUELLE

Adaptors

ORFS Accessories

Quick-release couplings

Ball valves, diverters and swivel fittings

Protections

## Protecciones textiles

*Textile protection*  
Protection textile  
*Protezioni tessili*

### ■ Protección fibra de vidrio y cerámica / Fiberglass protection / Protection en fibre de verre / Protezione in fibra di vetro

| 324



AVIDRIO

AVIDRIO S

ACERAMICA

AVIDRIO FA

ROVISIVE

CSVIDRIO

### ■ Protección textil / Textile protection / Protection textile / Protezioni tessile

| 326



GT

ABRAZADERA

### ■ Jitrakor cinta adhesiva / Jitrakor adhesive tape / Jitrakor bande adhesive / Jitrakor striscia adesiva

| 326



JITRAKOR

## Fijaciones de seguridad

*Safety fixation*  
Système de sécurité anti-fouet  
*Fune di sicurezza*

### ■ Elementos de fijación de seguridad / Safety fixation elements / Système de sécurité anti-fouet / Componenti per fune di sicurezza

| 327



STOPFUDIN CONF

STOPFUJIC

STOPFUDIN OPEN

STOPFUJIC OPEN

STOPFUSAE CONF

STOPFA

# Tapones de plástico

Plastic plugs  
Capuchons plastique  
Tappi di plastica

Adaptors

ORFS Accessories

Quick-release couplings

Ball valves, diverters and swivel fittings

Protections

## Tapón plástico hembra rosca BSP

Plastic female plug - BSP thread

Bouchons plastique femelle - gaz

Tappo plastica femmina BSP



THREAD ROSCA	UNITS PER BAG CANTIDAD / BOLSA	Part nº Referencia	€
1/8" BSP	100	TFG 1/8	0,14
1/4" BSP	100	TFG 1/4	0,16
3/8" BSP	100	TFG 3/8	0,18
1/2" BSP	100	TFG 1/2	0,18
5/8" BSP	100	TFG 5/8	0,27
3/4" BSP	100	TFG 3/4	0,20
1" BSP	100	TFG 1	0,29
1"1/4 BSP	100	TFG 1 1/4	0,42
1"1/2 BSP	100	TFG 1 1/2	0,46
2" BSP	50	TFG 2	0,69

## Tapón plástico hembra rosca Métrica

Plastic female plug - Metric thread

Bouchons plastique femelle Métriques

Tappo plastica femmina Metrico



THREAD ROSCA	UNITS PER BAG CANTIDAD / BOLSA	Part nº Referencia	€
M12x1.5	100	TFM 12X1.5	0,18
M14x1.5	100	TFM 14X1.5	0,17
M16x1.5	100	TFM 16X1.5	0,20
M18x1.5	100	TFM 18X1.5	0,19
M20x1.5	100	TFM 20X1.5	0,19
M22x1.5	100	TFM 22X1.5	0,20
M24x1.5	100	TFM 24X1.5	0,24
M26x1.5	100	TFM 26X1.5	0,21
M30x2	100	TFM 30X2	0,25
M36x2	100	TFM 36X2	0,31
M42x2	100	TFM 42X2	0,34
M52x2	50	TFM 52X2	0,71

## Tapón plástico hembra rosca UNF/JIC

Plastic female plug - UNF (JIC) thread

Bouchons plastique femelle - JIC-UNF

Tappo plastica femmina UNF/JIC



THREAD ROSCA	UNITS PER BAG CANTIDAD / BOLSA	Part nº Referencia	€
7/16" UNF	100	TFU 7/16	0,18
1/2" UNF	100	TFU 1/2	0,17
9/16" UNF	100	TFU 9/16	0,17
3/4" UNF	100	TFU 3/4	0,18
7/8" UNF	100	TFU 7/8	0,19
1"1/16 UNF	100	TFU 1 1/16	0,21
1"5/16 UNF	100	TFU 1 5/16	0,29
1"5/8 UNF	100	TFU 1 5/8	0,34
1"7/8 UNF	100	TFU 1 7/8	0,38

## Tapón plástico para bridas 3000 PSI

Plastic plugs for SAE 3000 PSI flanges

Bouchons plastique de brides SAE 3000 PSI

Tappo de plastica per flangia SAE 3000 PSI



DN	SERIE	SIZE TAMAÑO	UNITS PER BAG CANTIDAD / BOLSA	Part nº Referencia	€
30,2	3000 PSI	1/2"	100	TS 3000 1/2	0,29
38,1	3000 PSI	3/4"	100	TS 3000 3/4	0,25
44,5	3000 PSI	1"	100	TS 3000 1	0,30
50,8	3000 PSI	1"1/4	100	TS 3000 1 1/4	0,33
60,3	3000 PSI	1"1/2	100	TS 3000 1 1/2	0,37
71,4	3000 PSI	2"	100	TS 3000 2	0,41

## Tapón plástico para bridas 6000 PSI

Plastic plugs for SAE 6000 PSI flanges

Bouchons plastique de brides SAE 6000 PSI

Tappo de plastica per flangia SAE 6000 PSI



DN	SERIE	SIZE TAMAÑO	UNITS PER BAG CANTIDAD / BOLSA	Part nº Referencia	€
31,8	6000 PSI	1/2"	100	TS 6000 1/2	0,30
41,3	6000 PSI	3/4"	100	TS 6000 3/4	0,29
47,6	6000 PSI	1"	100	TS 6000 1	0,38
54	6000 PSI	1"1/4	100	TS 6000 1 1/4	0,40
63,5	6000 PSI	1"1/2	100	TS 6000 1 1/2	0,45
79,4	6000 PSI	2"	50	TS 6000 2	0,66

# Tapones de plástico

Plastic plugs  
Capuchons plastique  
Tappi di plastica

## Tapón plástico macho rosca BSP

Plastic male plug for BSP thread

Bouchons plastique mâle - BSP

Tappo plastica maschio BSP



THREAD ROSCA	UNITS PER BAG CANTIDAD / BOLSA	Part nº Referencia	€
1/8" BSP	100	TMG 1/8	0,16
1/4" BSP	100	TMG 1/4	0,15
3/8" BSP	100	TMG 3/8	0,17
1/2" BSP	100	TMG 1/2	0,21
5/8"	100	TMG 5/8	0,22
3/4" BSP	100	TMG 3/4	0,24
1" BSP	100	TMG 1	0,33
1"1/4 BSP	100	TMG 1 1/4	0,47
1"1/2 BSP	50	TMG 1 1/2	0,84
2" BSP	50	TMG 2	0,87

## Tapón plástico macho rosca Métrica

Plastic male plug for Metric thread

Bouchons plastique mâle - Métriques

Tappo plastica maschio Metrico



THREAD ROSCA	UNITS PER BAG CANTIDAD / BOLSA	Part nº Referencia	€
M12x1.5	100	TMM 12X1.5	0,15
M14x1.5	100	TMM 14X1.5	0,16
M16x1.5	100	TMM 16X1.5	0,17
M18x1.5	100	TMM 18X1.5	0,22
M20x1.5	100	TMM 20X1.5	0,21
M22x1.5	100	TMM 22X1.5	0,21
M24x1.5	100	TMM 24X1.5	0,23
M26x1.5	100	TMM 26X1.5	0,25
M30x2	100	TMM 30X2	0,28
M36x2	100	TMM 36X2	0,38
M42x2	50	TMM 42X2	0,58
M45x2	50	TMM 45X2	0,73
M52X2	50	TMM 52X2	0,90

## Tapón plástico macho rosca UNF/JIC

Plastic male plug for UNF (JIC) thread

Bouchons plastique mâle - JIC-UNF

Tappo plastica maschio UNF/JIC



THREAD ROSCA	UNITS PER BAG CANTIDAD / BOLSA	Part nº Referencia	€
7/16" UNF	100	TMU 7/16	0,18
1/2" UNF	100	TMU 1/2	0,17
9/16" UNF	100	TMU 9/16	0,16
3/4" UNF	100	TMU 3/4	0,19
7/8" UNF	100	TMU 7/8	0,21
1"1/16 UNF	100	TMU 1 1/16	0,25
1"5/16 UNF	100	TMU 1 5/16	0,33
1"5/8 UNF	50	TMU 1 5/8	0,60
1"7/8 UNF	50	TMU 1 7/8	0,72

## Cinta PTFE

PTFE Tape

Ruban PTFE

Nastro di PTFE



DESCRIPTION DESCRIPCIÓN	Part nº Referencia	€
1 roll	M299900	0,96
10 rolls	M2999010	8,76
200 rolls	M29990200	162,02



# Tapones de plástico

Plastic plugs  
Capuchons plastique  
Tappi di plastica

Adaptors

ORFS Accessories

Quick-release couplings

Ball valves, diverters and swivel fittings

Protections

## Tapones para latiguillos

Plugs for hoses

Capuchons pour tuyau

Tappi per tubi



UNITS PER BAG CANTIDAD / BOLSA	Part nº Referencia	€
100	LHT014	0,25
100	LHT016	0,25
100	LHT017	0,26
100	LHT019	0,28
100	LHT022	0,30
100	LHT024	0,35
100	LHT025	0,36
100	LHT027	0,37
100	LHT030	0,54
100	LHT032	0,59
100	LHT036	0,60
50	LHT041	0,81
50	LHT046	1,09
50	LHT050	1,19
50	LHT055	1,63
25	LHT060	2,37
25	LHT065	2,86
25	LHT070	2,89
25	LHT075	2,89
25	LHT080	2,98



REDUCTION OF CODES  
VALID FOR MULTIPLE CONNECTIONS  
INCREASE OF PRODUCTION  
EASY ASSEMBLY  
GREATER PROTECTION

REDUCCIÓN DE CÓDIGOS  
VALIDO PARA MULTIPLES CONEXIONES  
AUMENTO DE LA PRODUCCIÓN  
FÁCIL COLOCACIÓN  
MAYOR PROTECCIÓN



# Muelles

Springs  
Ressorts  
Molle

## Muelle de plástico perfil 8x1

Plastic spring profile 8x1

Ressort plastique profil 8x1



Molla di plastica 8x1

DN	LENGTH (M) LONGITUD (M)	Part nº Referencia	€
12	50	AMUELLE P12	4,15

## Muelle de plástico perfil 16x1

Plastic spring profile 16x1

Ressort plastique profil 16x1



Molla di plastica 16x1

DN	LENGTH (M) LONGITUD (M)	Part nº Referencia	€
13	50	AMUELLE P13	4,73
15	50	AMUELLE P15	4,83
16	50	AMUELLE P16	4,89
17	50	AMUELLE P17	4,94
21	50	AMUELLE P21	5,20
18	50	AMUELLE P18	4,99
20	50	AMUELLE P20	5,04
22	50	AMUELLE P22	5,31
25	50	AMUELLE P25	6,04
28	50	AMUELLE P28	6,78
30	50	AMUELLE P30	7,04

### AMUELLE P16x1

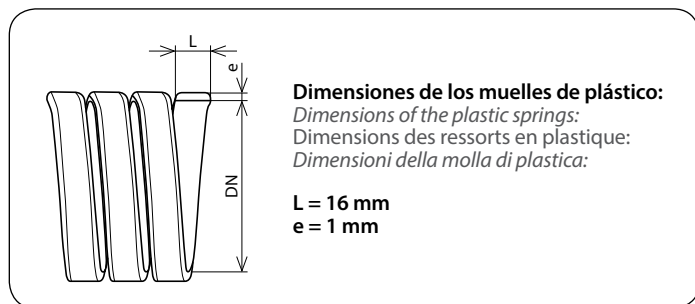

## Muelle de plástico perfil 16x2

Plastic spring profile 16x2

Ressort plastique profil 16x2



Molla di plastica 16x2

DN	LENGTH (M) LONGITUD (M)	Part nº Referencia	€
33	20	AMUELLE P33	10,82
35	20	AMUELLE P35	11,08
40	20	AMUELLE P40	11,56
38		AMUELLE P38	11,35
45	20	AMUELLE P45	13,13
50	20	AMUELLE P50	14,08
48		AMUELLE P48	13,61
55	20	AMUELLE P55	16,66
60	20	AMUELLE P60	18,65
70	20	AMUELLE P70	22,69
80	15	AMUELLE P80	26,16

### AMUELLE P16x2

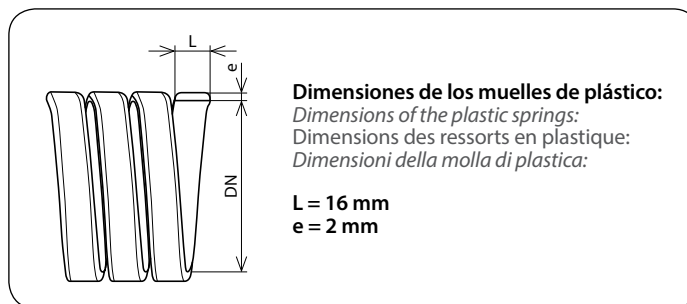

## Muelles de plástico flexible

Flexible plastic springs

Ressorts plastique flexible



Molla di plastica flessibili

DN	LENGTH (M) LONGITUD (M)	Thickness (mm) Espesor (mm)	SPIRAL PITCH PASO ESPIRAL	Part nº Referencia	€
16	20	1,2	12	AMUELLE PFLEX16	3,90
20	20	1,8	14,5	AMUELLE PFLEX20	4,53
23,5	20	1,9	15	AMUELLE PFLEX24	5,10
27	20	1,9	16	AMUELLE PFLEX27	5,83
30	20	2,2	18	AMUELLE PFLEX30	6,24
35,5	20	2,2	20,5	AMUELLE PFLEX35	9,42
43,5	20	2,3	23	AMUELLE PFLEX44	11,29

### AMUELLE PFLEX

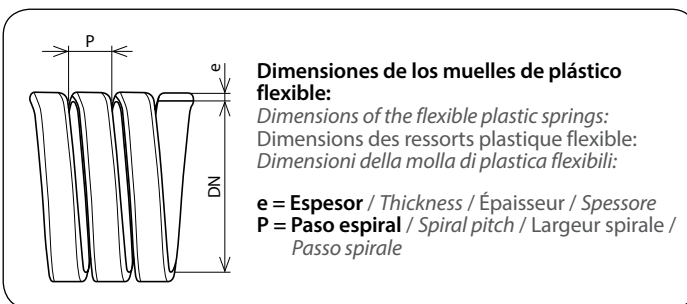

# Muelles

Springs  
Ressorts  
Molle

Adaptors

ORFS Accessories

Quick-release couplings

Ball valves, diverters and swivel fittings

Protections

## Muelle metálico plano perfil 5x1

Flat metallic spring 5x1

Ressort métallique plat profil 5x1

Molla in metallo piatta 5x1



DN	Part nº Referencia	€
16	AMUELLE16	9,80
18	AMUELLE18	9,85
20	AMUELLE20	10,01
22	AMUELLE22	10,66
24	AMUELLE24	11,25
26	AMUELLE26	11,78
28	AMUELLE28	13,50
30	AMUELLE30	13,82
32	AMUELLE32	14,03
34	AMUELLE34	14,73
38	AMUELLE38	15,64
40	AMUELLE40	16,17
42	AMUELLE42	17,35
47	AMUELLE47	18,69
52	AMUELLE52	19,44
60	AMUELLE60	21,96
68	AMUELLE68	26,94
72	AMUELLE72	28,22

### AMUELLE 5x1

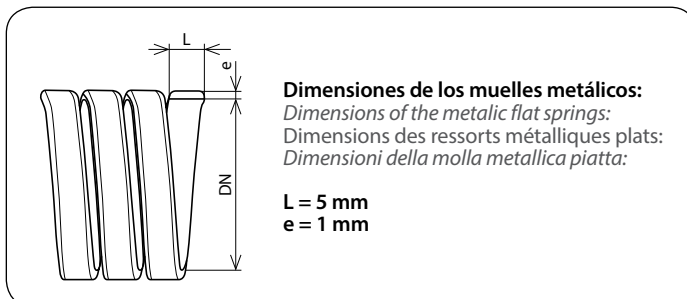

### Podemos suministrar muelles metálicos redondos en acero galvanizado bajo plano. Consúltenos

We can supply rounded metallic springs in galvanized steel under drawing. Please, enquire us  
 Nous pouvons fournir des ressorts métalliques ronds en acier galvanisé sur plan. Consultez-nous  
 Possiamo fornire molle metalliche rotonde in acciaio galvanizzato su ordine. Richieda

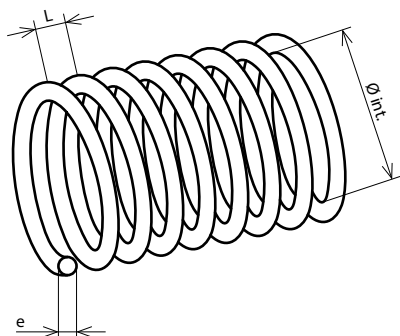

**Datos necesarios para consultar:**  
 Necessary data to enquire:  
 Données nécessaires pour consulter:  
 Dati necessari per l'ordine:

**L = espacio entre alambres / space between wires / place entre fils de fer / spazio tra**  
**e = espesor alambre / wire thickness / épaisseur / spessore**  
**Ø = Ø interior del muelle / Ø int. wire / Ø int. / interno della molla**  
**Longitud del muelle / Spring length / Longueur du ressort / Longhezza della molla**

# Protecciones textiles

Textile protection  
Protection textile  
Protezioni tessili

## Tubo de fibra de vidrio

Fibreglass tube

Gaine de fibre de verre

Tubo di fibra di vetro

Ø INNER MIN. Ø INT. MIN.	Ø INNER MAX. Ø INT. MAX.	DIAMETER (mm) DIAMETRO (mm)	Part n° Referencia	€
12	15	15	AVIDRIO 15	3,06
16	18	20	AVIDRIO 20	4,09
18	22	25	AVIDRIO 25	5,11
25	28	30	AVIDRIO 30	6,13
28	32	35	AVIDRIO 35	7,49
30	35	40	AVIDRIO 40	8,17
38	42	45	AVIDRIO 45	9,53
45	48	50	AVIDRIO 50	10,22
48	52	60	AVIDRIO 60	14,98
70	72	75	AVIDRIO 75	19,07



## Tubo de fibra de vidrio saturada

Saturated fibreglass tube

Gaine de fibre de verre saturée

Tubo in fibra di vetro saturato

Ø INNER MIN. Ø INT. MIN.	Ø INNER MAX. Ø INT. MAX.	Part n° Referencia	€
1/2"	3/4"	AVIDRIO FA 08	11,04
5/8"	1"	AVIDRIO FA 10	14,94
3/4"	1" 1/4	AVIDRIO FA 12	19,90
1"	1"3/4	AVIDRIO FA 16	29,61
1"1/2	2"1/4	AVIDRIO FA 24	45,61
2"1/2	4"	AVIDRIO FA 40	72,64



## Tubo de fibra de vidrio siliconado

Silicone fibreglass tube

Gaine de fibre de verre siliconée

Tubo di fibra di vetro siliconato

DN	Part n° Referencia	€
12	AVIDRIO S 12	18,68
16	AVIDRIO S 16	20,62
19	AVIDRIO S 19	23,71
25	AVIDRIO S 25	31,83
28	AVIDRIO S 28	35,92
32	AVIDRIO S 32	38,51
38	AVIDRIO S 38	39,80
51	AVIDRIO S 51	60,42
70	AVIDRIO S 70	119,63



## Revestimiento de fibra de vidrio con velcro

Fibreglass with velcro shield

Revêtement de fibre de verre avec velcro

Rivestimento di fibra di vetro con velcro

DIAMETER (mm) DIAMETRO (mm)	Part n° Referencia	€
1"1/2 / 38 mm	ROVISIVE 24	119,44
2" / 50 mm	ROVISIVE 32	139,34
2" 3/4 - 70 mm	ROVISIVE 44	168,49



## Cinta silicona

Silicone tape

Ruban silicone

Rotolo di Silicone

WIDTH (mm) ANCHURA (mm)	LENGTH (mm) LONGITUD (mm)	Part n° Referencia	€
25mm	Roll 11M	CSVIDRIO25	70,18
38mm	Roll 11m	CSVIDRIO38	104,88



## Tubo de fibra cerámica

Ceramic fibre tube

Gaine de fibre de céramique

Tubo in fibra di ceramica

DN	Part n° Referencia	€
15	ACERAMICA 15	8,06
20	ACERAMICA 20	9,69
25	ACERAMICA 25	11,11
30	ACERAMICA 30	15,20
40	ACERAMICA 40	20,15
50	ACERAMICA 50	25,13
60	ACERAMICA 60	30,20
70	ACERAMICA 70	37,71



# Fibras

Fibers  
Fibres  
Fibre

## AVIDRIO

### Tubo de fibra de vidrio

*Fibreglass tube*

Fibra de alta calidad tipo E, no se quema y soporta exposiciones a temperaturas de 540 °C. Resiste la mayoría de ácidos y alcalinos y no le afecta la mayoría de disolventes ni lejías/blanqueantes.

*High-quality fiber type E, no burns and supports exposure to temperatures of 540 °C. Resists most acids and alkalis and is unaffected by most solvents or bleach.*



## AVIDRIO S

### Tubo de fibra de vidrio siliconado

*Silicone fibreglass tube*

Diseñado para proteger mangueras, alambres, etc. de los peligros del calor elevado y de las llamas ocasionales. Protección continua a 260 °C, soporta picos de hasta 1200 °C. Es resistente a fluidos hidráulicos, aceites lubricantes y combustibles. La funda siliconada protege contra la pérdida de energía en tubo rígido y manguera.

*Designed to protect hoses, wires and cables from the hazards of high heat and occasional flame. It protects continuously to 260 °C and will withstand a molten splash at 1200 °C. Resistant to hydraulic fluids, lubricating oils and fuels, it insulates against energy loss in piping and hosing.*



## AVIDRIO FA

### Fibra de vidrio saturada

*Saturated fibreglass tube*

Proporciona protección continua hasta 540 °C. Es resistente a la mayoría de ácidos y alcalinos y no le afectan la mayoría de los disolventes ni lejías/blanqueantes. Es altamente flexible y adaptable; esto permite que una misma protección pueda colocarse en varios diámetros de tubo o incluso en montajes ya terminados (manguera/tubo + conexión/rácor). También es muy útil en longitudes largas de manguera o cable.

*Provides continuous protection up to 540 °C. It is resistant to most acids and alkalis and is not affected by most of the solvents or bleach. It is highly flexible and adaptable, this allows to place the same protection on various diameters of pipe, or even on already finished assemblies (hose/pipe + connection/fitting). It is also useful in long lengths of hose or cable.*

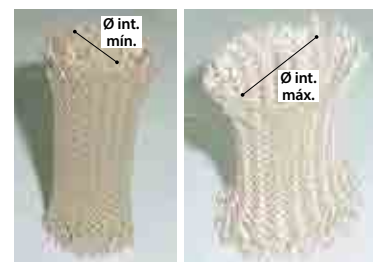

## ROVISIVE

### Revestimiento de fibra de vidrio siliconada con velcro

*Silicon fibreglass with velcro shield*

Diseñado para proteger mangueras, alambres, etc. de los peligros del calor elevado y de las llamas ocasionales. Protección continua a 260 °C, soporta picos de hasta 1200 °C. Su sistema de cierre con velcro permite el montaje *in situ* sin necesidad de quitar y poner los racores y terminales.

*Designed to protect hoses, wires and cables from the hazards of high heat and occasional flame. It protects continuously to 260 °C and will withstand a molten splash at 1200 °C. Its Velcro closure system allows application in-situ without the need to dismantle and reconnect fittings and terminations.*



## ACERAMICA

### Tubo de fibra cerámica

*Ceramic fibre tube*

La fibra cerámica está compuesta de silicato de aluminio. Es considerablemente resistente a altas temperaturas y tiene una estabilidad química excelente, resiste a los agentes más corrosivos, con la excepción del ácido fosfórico, ácido clorhídrico y bases fuertes. Tiene una excelente insonorización y aislamiento eléctrico, es de baja densidad y alta flexibilidad. No gotea en caso de incendio (no contiene agua). Sus características térmicas y físicas no se alteran por el agua, vapor o aceite.

*Ceramic fibre is composed of aluminium silicate. Is considerably resistant to high temperatures and has excellent chemical stability, resists to most corrosive agents, with the exception of phosphoric acid, hydrochloric acid and strong alkalis. It has excellent soundproofing and electric insulation, low density and high flexibility. Not dripping in case of fire (does not contain water). Its thermal and physical characteristics are not altered by water, steam or oil.*



## Protecciones textiles

Textile protection  
Protection textile  
Protezioni tessili

### Tubo de protección textil

Textile protection tube

Gaine de protection textile

Tubo di protezione tessile



L	Ø OUTER Ø EXT.	Ø INNER Ø INT.	Part n° Referencia	€
35	20	18	GT35	1,27
40	22	20	GT40	1,37
45	25	23	GT45	1,70
50	28	26	GT50	1,80
55	32	30	GT55	1,99
65	38	36	GT65	2,27
80	45	43	GT80	2,98
120	70	68	GT120	3,72
150	90	85	GT150	7,58

### Accesorios tubo de protección textil

Textile protection tube accessories

Accessoires pour gaine de protection textile

Accessori per la protezione dei tessili



Ø INNER MIN. Ø INT. MIN.	Ø INNER MAX. Ø INT. MAX.	Part n° Referencia	€
13	15	ABRAZADERA 13-15	0,56
15	18	ABRAZADERA 15-18	0,71
20	23	ABRAZADERA 20-23	0,98
22	25	ABRAZADERA 22-25	1,20
23	27	ABRAZADERA 23-27	1,35
25	28	ABRAZADERA 25-28	1,31
40	43	ABRAZADERA 40-43	2,81
43	46	ABRAZADERA 43-46	2,66

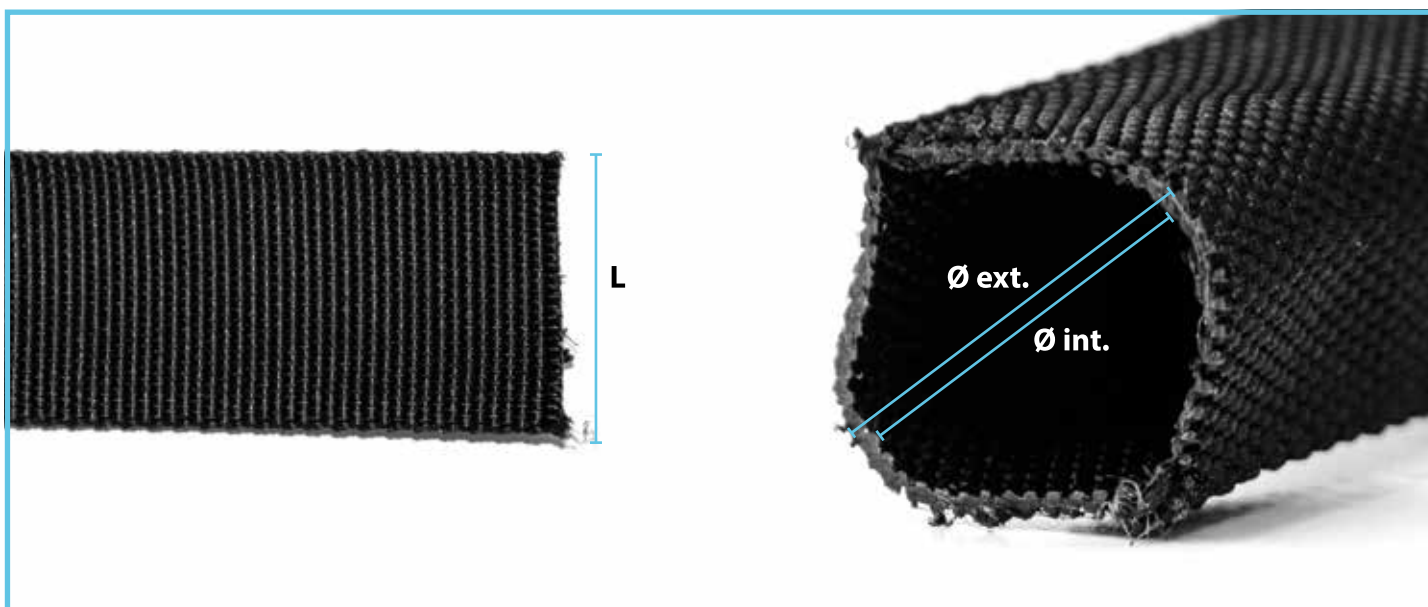

### Jitrakor cinta adhesiva

Jitrakor adhesive tape

Jitrakor bande adhesive

Jitrakor striscia adesiva



L (mm)	WIDTH (mm) ANCHURA (mm)	Part n° Referencia	€
L 10.000	50	JITRAKOR	29,91

# Fijaciones de seguridad

Safety fixation

Système de sécurité anti-fouet

Fune di sicurezza

Adaptors

ORFS Accessories

Quick-release couplings

Ball valves, diverters and swive fittings

Protections

## Protección para DIN 2353

Retaining system to DIN 2353

Platines de fixation pour DIN 2353

Elementi di tenuta per DIN 2353

Ø INNER Ø INT.	DESCRIPTION DESCRIPCIÓN	MAX. PRESSURE (bar) PRESIÓN MAX. (bar)	Part n° Referencia	€
14.5 mm	8L - 1/4"	450	STOPFUDIN 145 CONF	<b>23,10</b>
17 mm	8S - 10L - 3/8"	445	STOPFUDIN 17 CONF	<b>23,10</b>
18.5 mm	10S - 12L	420	STOPFUDIN 185 CONF	<b>23,10</b>
20.5 mm	12S	420	STOPFUDIN 205 CONF	<b>23,10</b>
22.5 mm	14S - 15L - 1/2"	420	STOPFUDIN 225 CONF	<b>23,44</b>
24.5 mm	16S - 5/8"	420	STOPFUDIN 245 CONF	<b>23,44</b>
26.5 mm	18L - 3/4"	420	STOPFUDIN 265 CONF	<b>23,44</b>
30.5 mm	20S - 22L	420	STOPFUDIN 305 CONF	<b>24,13</b>
34 mm	1"	420	STOPFUDIN 34 CONF	<b>25,86</b>
36.5 mm	25S - 28L	420	STOPFUDIN 365 CONF	<b>25,86</b>
42.5 mm	30S - 1" 1/4	420	STOPFUDIN 425 CONF	<b>26,20</b>
45.5 mm	35L	420	STOPFUDIN 455 CONF	<b>26,55</b>
49 mm	1" 1/2	420	STOPFUDIN 49 CONF	<b>26,89</b>
52.5 mm	38S - 42L	385	STOPFUDIN 525 CONF	<b>27,24</b>
60 mm	2"	350	STOPFUDIN 60 CONF	<b>27,58</b>

Ver página 329 / See page 329 / Voir page 329 / Vedere p. 329

## Protección para JIC 37°

Retaining system to JIC 37°

Platines de fixation pour JIC 37°

Elementi di tenuta per JIC 37°

Ø INNER Ø INT.	DESCRIPTION DESCRIPCIÓN	MAX. PRESSURE (bar) PRESIÓN MAX. (bar)	Part n° Referencia	€
11,5	7/16	450	STOPFUJIC 115 S	<b>22,07</b>
13,2	1/2	450	STOPFUJIC 132 S	<b>22,07</b>
14,8	9/16	450	STOPFUJIC 148 S	<b>22,07</b>
19,5	3/4	300	STOPFUJIC 195 S	<b>22,07</b>
22,8	7/8	300	STOPFUJIC 228 S	<b>22,41</b>
27,5	1 1/16	300	STOPFUJIC 275 S	<b>23,10</b>
30,7	1 3/16	300	STOPFUJIC 307 S	<b>23,10</b>
34	1 5/16	450	STOPFUJIC 34 L	<b>28,27</b>
34	1 5/16	450	STOPFUJIC 34 S	<b>24,82</b>
41,5	1 5/8	450	STOPFUJIC 415 L	<b>29,31</b>
41,5	1 5/8	450	STOPFUJIC 415 S	<b>25,86</b>
48	1 7/8	450	STOPFUJIC 48 L	<b>29,31</b>
48	1 7/8	450	STOPFUJIC 48 S	<b>29,31</b>
64	2 1/2	450	STOPFUJIC 64 L	<b>37,23</b>

## Protección para DIN 2353 OPEN

Retaining system to DIN 2353 OPEN

Platines de fixation pour DIN 2353 OPEN

Elementi di tenuta per DIN 2353 OPEN

Ø INNER Ø INT.	DESCRIPTION DESCRIPCIÓN	MAX. PRESSURE (bar) PRESIÓN MAX. (bar)	Part n° Referencia	€
14.5 mm	8L - 1/4"	450	STOPFUDIN 145 OPEN	<b>43,10</b>
17 mm	8S - 10L - 3/8"	445	STOPFUDIN 17 OPEN	<b>43,10</b>
18.5 mm	10S - 12L	420	STOPFUDIN 185 OPEN	<b>43,10</b>
20.5 mm	12S	420	STOPFUDIN 205 OPEN	<b>43,10</b>
22.5 mm	14S - 15L - 1/2"	420	STOPFUDIN 225 OPEN	<b>43,10</b>
24.5 mm	16S - 5/8"	420	STOPFUDIN 245 OPEN	<b>43,10</b>
26.5 mm	18L - 3/4"	420	STOPFUDIN 265 OPEN	<b>43,10</b>
30.5 mm	20S - 22L	420	STOPFUDIN 305 OPEN	<b>44,13</b>
34 mm	1"	420	STOPFUDIN 34 OPEN	<b>49,99</b>
36.5 mm	25S - 28L	420	STOPFUDIN 365 OPEN	<b>49,99</b>
42.5 mm	30S - 1" 1/4	420	STOPFUDIN 425 OPEN	<b>50,68</b>
45.5 mm	35L	420	STOPFUDIN 455 OPEN	<b>50,68</b>
49 mm	1" 1/2	420	STOPFUDIN 49 OPEN	<b>50,68</b>
52.5 mm	38S - 42L	385	STOPFUDIN 525 OPEN	<b>51,37</b>
60 mm	2"	350	STOPFUDIN 60 OPEN	<b>51,71</b>

## Protección para JIC 37° OPEN

Retaining system to JIC 37° OPEN

Platines de fixation pour JIC 37° OPEN

Elementi di tenuta per JIC 37° OPEN

Ø INNER Ø INT.	DESCRIPTION DESCRIPCIÓN	MAX. PRESSURE (bar) PRESIÓN MAX. (bar)	Part n° Referencia	€
11,5	7/16	450	STOPFUJIC 115 S OPEN	<b>43,10</b>
13,2	1/2	450	STOPFUJIC 132 S OPEN	<b>43,10</b>
14,8	9/16	450	STOPFUJIC 148 S OPEN	<b>43,10</b>
19,5	3/4	300	STOPFUJIC 195 S OPEN	<b>43,10</b>
22,8	7/8	300	STOPFUJIC 228 S OPEN	<b>43,10</b>
27,5	1 1/16	300	STOPFUJIC 275 S OPEN	<b>44,13</b>
30,7	1 3/16	300	STOPFUJIC 307 S OPEN	<b>44,82</b>
34	1 5/16	450	STOPFUJIC 34 L OPEN	<b>49,99</b>
34	1 5/16	450	STOPFUJIC 34 S OPEN	<b>46,54</b>
41,5	1 5/8	450	STOPFUJIC 415 L OPEN	<b>51,02</b>
41,5	1 5/8	450	STOPFUJIC 415 S OPEN	<b>47,23</b>
48	1 7/8	450	STOPFUJIC 48 L OPEN	<b>51,37</b>
48	1 7/8	450	STOPFUJIC 48 S OPEN	<b>47,92</b>
64	2 1/2	450	STOPFUJIC 64 L OPEN	<b>52,06</b>

Assembly where hoses have already been installed.



Montaje en mangueras previamente instaladas.

Novedad  
New

# Fijaciones de seguridad

Safety fixation

Système de sécurité anti-fouet

Fune di sicurezza

## Protección para bridas

Retaining system for flanges

Platines de fixation pour brides

Protezione per flangie



Ø INNER Ø INT.	DESCRIPTION DESCRIPCIÓN	MAX. PRESSURE (bar) PRESIÓN MAX. (bar)	Part nº Referencia	€
8.5 mm	SAE FLANGE 1/2" 3000 & 6000 PSI	415	STOPFUSAE 085 CONF	26,20
10,5	SAE FLANGE 3/4"-1" -1" 1/4 3000 PSI & 3/4" 6000 PSI	420	STOPFUSAE 2105 CONF	26,55
10.5 mm	SAE FLANGE 3/4"-1" -1" 1/4 3000 PSI & 3/4" 6000 PSI	420	STOPFUSAE 105 CONF	26,89
12.5 mm	SAE FLANGE 1"-1/2 -2" 3000 PSI & 1" 6000 PSI	420	STOPFUSAE 125 CONF	27,58
14.5 mm	SAE FLANGE 1" 1/4 6000 PSI	420	STOPFUSAE 145 CONF	27,58
16.5 mm	SAE FLANGE 1" 1/2 6000 PSI	420	STOPFUSAE 165 CONF	28,27
20.5 mm	SAE FLANGE 2" 6000 PSI	350	STOPFUSAE 205 CONF	28,27
25 MM	SAE FLANGE 2" 1/2 6000 PSI	350	STOPFUSAE 25 CONF	76,88
32 MM	SAE FLANGE 3" 6000 PSI	210	STOPFUSAE 32 CONF	81,02

Ver página 329 / See page 329 / Voir page 329 / Vedere p. 329

## Abrazaderas

Fixation clamps

Colliers de fixation

Collari fissaggio



Ø INNER Ø INT.	Part nº Referencia	€
11-11.5 mm	STOPFA11115	7,24
12-12.5 mm	STOPFA12125	7,24
13-13.5 mm	STOPFA13135	7,24
14-15 mm	STOPFA1415	7,24
16-17 mm	STOPFA1617	7,24
17-18 mm	STOPFA1718	7,24
18-19 mm	STOPFA1819	7,24
20-21 mm	STOPFA2021	7,24
21-22 mm	STOPFA2122	7,24
22-23 mm	STOPFA2223	7,24
24-25 mm	STOPFA2425	7,59
25-26 mm	STOPFA2526	7,59
26-27 mm	STOPFA2627	7,59
27-28 mm	STOPFA2728	7,93
28-29 mm	STOPFA2829	7,93
30-31 mm	STOPFA3031	7,93
32-33 mm	STOPFA3233	7,93
34-35 mm	STOPFA3435	8,27
36-37 mm	STOPFA3637	8,27
38-39 mm	STOPFA3839	8,27
39-40 mm	STOPFA3940	8,27
40-41 mm	STOPFA4041	8,62
42-43 mm	STOPFA4243	8,62
43-44 mm	STOPFA4344	8,62
44-45 mm	STOPFA4445	8,62
45-47 mm	STOPFA4547	10,00
48-50 mm	STOPFA4850	10,00
51-53 mm	STOPFA5153	10,34
53-54 mm	STOPFA5354	10,34
54-56 mm	STOPFA5456	10,69
57-59 mm	STOPFA5759	10,69
60-62 mm	STOPFA6062	11,03
63-65 mm	STOPFA6365	11,03
66-68 mm	STOPFA6668	11,38
69-71 mm	STOPFA6971	11,38
72-74 mm	STOPFA7274	11,38
75-77 mm	STOPFA7577	11,38
78-80 mm	STOPFA7880	11,72
81-83 mm	STOPFA8183	11,72
84-86 mm	STOPFA8486	11,72
87-89 mm	STOPFA8789	12,07
90-92 mm	STOPFA9092	12,07
93-95 mm	STOPFA9395	12,41



# Fijaciones de seguridad

Safety system

Système de sécurité anti-fouet

Fune di sicurezza

Referencia Part No. Référence Codice	Ø	SP	Recomendado para Recommended for Recommandé pour Consigliato per
STOPFUDIN 145 CONF	14,5	2,5	8L - 1/4"
STOPFUDIN 17 CONF	17	2,5	8S - 10L - 3/8"
STOPFUDIN 185 CONF	18,5	2,5	10S - 12L
STOPFUDIN 205 CONF	20,5	2,5	12S
STOPFUDIN 225 CONF	22,5	2,5	14S - 15L - 1/2"
STOPFUDIN 245 CONF	24,5	2,5	16S - 5/8"
STOPFUDIN 265 CONF	26,5	2,5	18L - 3/4"
STOPFUDIN 305 CONF	30,5	3	20S - 22L
STOPFUDIN 34 CONF	34	3	1"
STOPFUDIN 365 CONF	36,5	3	25S - 28L
STOPFUDIN 425 CONF	42,5	3	30S - 1 1/4"
STOPFUDIN 455 CONF	45,5	3	35L
STOPFUDIN 49 CONF	49	3	1 1/2"
STOPFUDIN 525 CONF	52,5	3	38S - 42L
STOPFUDIN 60 CONF	60	3	2"
STOPFUSAE 085 CONF	8,5	4	Brida SAE 1/2" 3000 y 6000 PSI
STOPFUSAE 105 CONF	10,5	4	Brida SAE 3/4" - 1" - 1 1/4" 3000 PSI y 3/4" 6000 PSI
STOPFUSAE 125 CONF	12,5	4	Brida SAE 1 1/2" - 2" 3000 PSI y 1" 6000 PSI
STOPFUSAE 145 CONF	14,5	4	Brida SAE 1 1/4" 6000 PSI
STOPFUSAE 165 CONF	16,5	4	Brida SAE 1 1/2" 6000 PSI
STOPFUSAE 205 CONF	20,5	4	Brida SAE 2" 6000 PSI

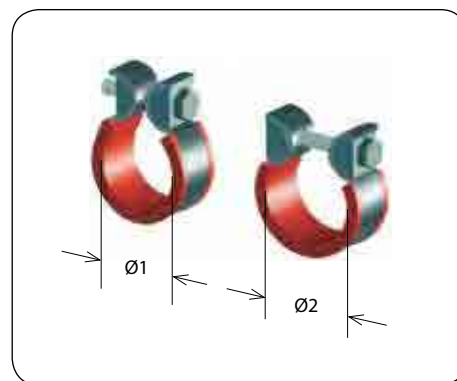
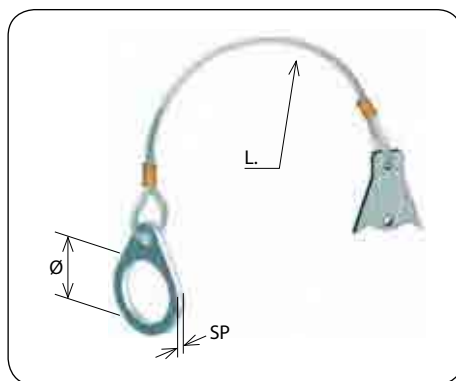

# UN PROVEEDOR MÚLTIPLES SOLUCIONES

FABRICACIÓN · MANUFACTURING



LOGÍSTICA · LOGISTICS



ÁREA CALIDAD · QUALITY DEPARTMENT



ÁREA TÉCNICA · TECHNICAL DEPARTMENT



# ONE SUPPLIER MULTIPLE SOLUTIONS

[www.dicsaes.com](http://www.dicsaes.com)

SERVICIOS COMERCIALES · COMMERCIAL SERVICES



PLATAFORMA DIGITAL · DIGITAL PLATFORM



TALLER HIDRÁULICA · HYDRAULIC WORKSHOP



TALLER LATIGUILLOS · HOSE ASSEMBLY WORKSHOP



TALLER SOLDADURA · WELDING WORKSHOP







**Tuberías y espirales***Pipe and springs*

Tubes et serpentins

*Tubi e spirali*

1

**Racores***Pneumatic fittings*

Raccords pneumatiques

*Raccordi*

2

**Enchufes rápidos neumáticos***Quick release couplings*

Coupleurs pneumatiques

*Innesti rapidi*

3

## Tuberías y espirales

*Pipe and springs*

Tubes et serpentins

*Tubi e spirali*

## Espirales y tuberías de poliamida y poliuretano

*Polyamide and polyurethane springs and tube*

Serpentins et tube de polyamide et polyuréthane

*Spirali e tubi in poliammide e poliuretano*

337

1

## Espirales y tuberías de poliamida y poliuretano

*Polyamide and polyurethane springs and tube*

*Serpentins et tube de polyamide et polyuréthane*

*Spirali e tubi in poliammide e poliuretano*

### ■ Tuberías de poliamida y poliuretano / *Polyamide and polyurethane tubes / Tubes de polyamide et polyuréthane / Tubi in poliammide e poliuretano*

| 337



POL...NAT



POL...NE



POL...AZ



PUR...AZ

### ■ PTFE sin malla / *PTFE without braid / PTFE sans tresse / PTFE senza maglia*

| 337



M2950

### ■ Espirales de poliamida y poliuretano / *Polyamide and Polyurethane springs / Serpentins polyamide y polyuréthane / Spirali in poliammide e poliuretano*

| 338



ESPIRPOL



SPUR



HPUR



# Espirales y tuberías de poliamida y poliuretano

Polyamide and polyurethane springs and tube  
Serpentins et tube de polyamide et polyuréthane  
Spirali e tubi in poliammide e poliuretano

## Tuberías Poliamida natural

Natural polyamide pipe

Tubes polyamide naturelle

Tubis in Poliammide naturale



PIPE TUBO	LENGTH (M) LONGITUD (M)	Part n° Referencia	€
2,5x4 mm	25	POL2.5X4NAT	17,44
4x6 mm	25	POL4X6NAT	23,31
6x8 mm	25	POL6X8NAT	33,52
8x10 mm	25	POL8X10NAT	42,20
10x12 mm	25	POL10X12NAT	50,97
2,5x4 mm	100	POL2.5X4NAT-100	62,01
4x6 mm	100	POL4X6NAT-100	93,25
6x8 mm	100	POL6X8NAT-100	134,09
8x10 mm	100	POL8X10NAT-100	168,90
10x12 mm	100	POL10X12NAT-100	203,86

\*€/rollo / \*€/roll / \*€/rouleau / \*€/rotolo

## Tuberías Poliamida negro

Black polyamide pipe

Tubes polyamide noir

Tubis in Poliammide nero



PIPE TUBO	LENGTH (M) LONGITUD (M)	Part n° Referencia	€
2,5x4 mm	25	POL2.5X4NE	11,66
4x6 mm	25	POL4X6NE	18,89
6x8 mm	25	POL6X8NE	23,31
8x10 mm	25	POL8X10NE	33,52
10x12 mm	25	POL10X12NE	39,31
2,5x4 mm	100	POL2.5X4NE-100	46,54
4x6 mm	100	POL4X6NE-100	75,73
6x8 mm	100	POL6X8NE-100	93,17
8x10 mm	100	POL8X10NE-100	134,01
10x12 mm	100	POL10X12NE-100	157,32

\*€/rollo / \*€/roll / \*€/rouleau / \*€/rotolo

## PTFE sin malla

PTFE without braid

PTFE sans tresse

PTFE senza maglia



PIPE TUBO	LENGTH (M) LONGITUD (M)	Part n° Referencia	€
2x4	25	M2950204	83,23
4x6	25	M2950406	122,25
6x8	25	M2950608	176,87
2x4	100	M2950204-100	332,93
4x6	100	M2950406-100	488,99
6x8	100	M2950608-100	707,47

\*€/rollo / \*€/roll / \*€/rouleau / \*€/rotolo

## Tuberías Poliamida azul

Blue polyamide pipe

Tubes polyamide bleu

Tubis in Poliammide blu



PIPE TUBO	LENGTH (M) LONGITUD (M)	Part n° Referencia	€
4x6 mm	25	POL4X6AZ	46,47
6x8 mm	25	POL6X8AZ	63,29
8x10 mm	25	POL8X10AZ	79,49
10x12 mm	25	POL10X12AZ	100,59

\*€/rollo / \*€/roll / \*€/rouleau / \*€/rotolo

## Tuberías Poliuretano azul

Blue polyurethane pipe

Tubes polyuréthane bleu

Tubis in Poliuretano blu



PIPE TUBO	LENGTH (M) LONGITUD (M)	Part n° Referencia	€
2x4 mm	25	PUR2X4AZ	22,66
4x6 mm	25	PUR4X6AZ	32,75
6x8 mm	25	PUR6X8AZ	43,75
8x10 mm	25	PUR8X10AZ	54,61
9x12 mm	25	PUR9X12AZ	87,84
2,5x4 mm	100	PUR2.5X4AZ-100	42,86
4x6 mm	100	PUR4X6AZ-100	76,65
6x8 mm	100	PUR6X8AZ-100	119,08
6,5x10 mm	100	PUR6.5X10AZ-100	223,59
8x12 mm	100	PUR8X12AZ-100	284,67

\*€/rollo / \*€/roll / \*€/rouleau / \*€/rotolo

# Espirales y tuberías de poliamida y poliuretano

Polyamide and polyurethane springs and tube  
Serpentins et tube de polyamide et polyuréthane  
Spirali e tubi in poliammide e poliuretano

## Espirales poliamida azul

Blue polyamide springs

Serpentins polyamide bleu



Spirali poliuretano blu

PIPE TUBO	LENGTH (M) LONGITUD (M)	Part n° Referencia	€
4x6 mm	30	ESPIRPOL4X6AZ	48,00
6x8 mm	30	ESPIRPOL6X8AZ	63,47
8x10 mm	30	ESPIRPOL8X10AZ	107,93
10x12 mm	30	ESPIRPOL10X12AZ	136,55

\*€/rollo / \*€/roll / \*€/rouleau / \*€/rotolo

## Espirales poliuretano sin racores

Polyurethane springs without fittings

Serpentins polyuréthane sans raccords



Spirale poliuretano senza raccordi

PIPE TUBO	LENGTH (M) LONGITUD (M)	Part n° Referencia	€
4x6 mm	5	SPUR4X6 5	6,83
4x6 mm	7,5	SPUR4X6 7.5	10,45
4x6 mm	10	SPUR4X6 10	13,91
5X8 mm	5	SPUR5X8 5	8,36
5X8 mm	7.5	SPUR5X8 7.5	12,62
5X8 mm	10	SPUR5X8 10	16,80
6,5x10 mm	5	SPUR6.5X10 5	14,79
6,5x10 mm	7,5	SPUR6.5X10 7.5	22,19
6,5x10 mm	10	SPUR6.5X10 10	29,58

\*€/rollo / \*€/roll / \*€/rouleau / \*€/rotolo

## Espirales poliuretano con racores

Polyurethane springs with fittings

Serpentins polyuréthane avec raccords



Spirale poliuretano con raccordi

PIPE TUBO	LENGTH (M) LONGITUD (M)	Part n° Referencia	€
4x6 mm	5	HPUR4X6 5	42,35
4x6 mm	7,5	HPUR4X6 7.5	50,14
4x6 mm	10	HPUR4X6 10	53,26
5X8 mm	5	HPUR5X8 5	15,44
5X8 mm	7.5	HPUR5X8 7.5	19,66
5X8 mm	10	HPUR5X8 10	23,88
6,5x10 mm	5	HPUR6.5X10 5	32,74
6,5x10 mm	7,5	HPUR6.5X10 7.5	29,86
6,5x10 mm	10	HPUR6.5X10 10	48,14

\*€/rollo / \*€/roll / \*€/rouleau / \*€/rotolo

# MEJORAS CONTINUAS EN EL ÁREA TÉCNICA

TECHNICAL DEPARTMENT MAKES THINGS BETTER

NUEVO MEDIOS  
NEW MACHINES



Banco de pruebas minicentrales  
Minipower Packs Test bench

Reparación máquinas de prensar  
Crimping machines repairation

Cortadora orbital  
Orbital cutting machine

Enrolladora packs manguera  
Hose packs winder

Embaladora tubo  
Tube wrapping machine

✓ Diseño propio, proceso de mejora continua

✓ Piezas especiales para clientes según especificaciones o muestras

✓ Catálogos técnicos y fichas técnicas de productos

✓ Asesoría técnica en Conducciones y Componentes Hidráulicos

✓ Diseño de grupos hidráulicos y búsqueda de soluciones de aprovisionamiento

✓ Asesoramiento para fabricantes de maquinaria en kits de primeros equipos

✓ Own design, continual improvement process

✓ Special products for customers according to specifications or samples

✓ Technical Catalogues and price lists

✓ Technnical advising in Hydraulic and Pneumatic Conducts

✓ Hydraulic groups design and search of supply solutions

✓ Technical support for O.E.M. (Original Equipment Manufacturer)

IMPRESIÓN 3D  
3D PRINT

PLANO  
DRAW

DISEÑO 3D  
3D DESIGN

PROTOTIPO  
PROTOTYPE



## Racores

*Pneumatic fittings*

Raccords pneumatiques

*Raccordi*

### Conexión Push-in automático

347

*Push-in Fittings*

Raccords Automatiques Push-in

*Raccordi automatici Push-in*

### Conexión con espiga

356

*Hose tail-M BSPT tapered*

Raccords avec embout

*Raccordi con embout*

### Conexión Push-on

357

*Push-on Fittings*

Raccords Push-on

*Raccordi Push-on*

### Adaptador

362

*Adaptors*

Adaptateurs

*Adattatori*

2

# Conexión Push-in automático

*Push-in Fittings*

*Raccords Automatiques Push-in*

*Raccordi automatici Push-in*

## ■ Racordaje tecnopolímero cónico / *Push-in Technopolymeric tapered fittings* / Raccords Push-in techno-polymère conique / Raccordi tecnopolimero Push-in conico

347



## ■ Racordaje tecnopolímero cilíndrico / *Push-in Technopolymeric cylindrical fittings* / Raccords Push-in techno-polymère cylindrique / Raccordi tecnopolimero Push-in cilindrico

348



## ■ Racordaje tecnopolímero otros / *Other Push-in Technopolymeric fittings* / Raccords Push-in techno-polymère - autres / Raccordi tecnopolimero Push-in altri

350



## ■ Racordaje metálico cónico / *Metallic Push-in tapered fittings* / Raccords Push-in métallique conique / Raccordi metallici Push-in conico

353



# Conexión Push-in automático

*Push-in Fittings*

*Raccords Automatiques Push-in*

*Raccordi automatici Push-in*

## ■ Racordaje metálico cilíndrico / *Metallic Push-in cylindrical fittings* / Raccords Push-in métallique cylindrique / *Raccordi metallici Push-in cilindrico*

353



MPCCI



MPCF



MPHCI



MPLCI



MSCL



MPTCI



MPSTCI

## ■ Racordaje metálico otros / *Other Metallic Push-in fittings* / Raccords Push-in métallique - autres / *Raccordi metallici Push-in vari*

355



MPUC



MPMM



MPUL



MPUT



MPY



TAP



50600

## Conexión con espiga

*Hose tail-M BSPT tapered*

*Raccords avec embout*

*Raccordi con embout*

- **Racordaje con espiga cónico / Tapered hose tail fittings / Raccords avec embout conique / Raccordi con estremità conica**

| 356



3040

3055

- **Racordaje con espiga cilíndrico / Cylindrical hose tail fittings / Raccords avec embout cylindrique / Raccordi con estremità cilindrica**

| 356



3045

3050

3045A



# Conexión Push-on

Push-on Fittings  
Raccords Push-on  
Raccordi Push-on

Pipe and springs

Pneumatic fittings

Quick release couplings

## Conexión Push-on sin espiral / Push-on fittings without spring / Raccords Push-on sans spirale / Raccordi Push-on sin spirali

357



## Conexión Push-on con muelle / Push-on fittings with nut and spring / Raccords Push-on avec ressort / Raccordi Push-on con molla

360



# Adaptador

Adaptors  
Adaptateurs  
Adattatori

## ■ Adaptadores Rectos / Straight adaptors / Adaptateurs droits / Adattatori dirriti

| 362



## ■ Tapones / Plugs / Bouchons / Tappi

| 364



## ■ Forja en codo / Elbow forge / Forges en coude / Forgia a 90°

| 365



## ■ Forja en T / Forge in T / Forges en T / Forgia en T

| 365



## ■ Forja en Cruz e Y / Forge in Cross and Y / Forges en Croix et Y / Forgia cruce e Y

| 366



## ■ Tacos / Squares / Nourrices de distribution / Cruces

| 366



# Conexión Push-in automático

Push-in Fittings

Raccords Automatiques Push-in

Raccordi automatici Push-in

## Auto. Pol.-M BSPT cónico/M métrico

Push-in Pol. - M BSPT tapered/M metric

Push-in Pol. - M BSPT conique /M métrique

Automatico diritto maschio



PIPE TUBO	THREAD ROSCA	Part nº Referencia	€
10 mm	1/8"	PC 1001	1,24
4 mm	1/8"	PC 0401	0,79
4 mm	1/4"	PC 0402	0,85
4 mm	M5	PC 04M5	0,76
6 mm	1/8"	PC 0601	0,84
6 mm	1/4"	PC 0602	0,94
6 mm	3/8"	PC 0603	1,32
8 mm	1/8"	PC 0801	0,91
8 mm	1/4"	PC 0802	0,94
8 mm	3/8"	PC 0803	1,35
10 mm	1/4"	PC 1002	1,38
10 mm	3/8"	PC 1003	1,39
10 mm	1/2"	PC 1004	2,22
12 mm	1/4"	PC 1202	1,94
12 mm	3/8"	PC 1203	1,94
12 mm	1/2"	PC 1204	2,22

## Auto. Pol.-codo orientable M BSPT cónico

Push-in Pol. - elbow banjo M BSPT tapered

Push-in Pol. - coude ajustable M BSPT conique

Automatico estremita tubolare a 90



PIPE TUBO	THREAD ROSCA	Part nº Referencia	€
4 mm	1/8"	PH 0401	1,64
6 mm	1/8"	PH 0601	1,59
6 mm	1/4"	PH 0602	2,38
8 mm	1/8"	PH 0801	1,64
8 mm	1/4"	PH 0802	7,22
8 mm	3/8"	PH 0803	4,09
10 mm	1/4"	PH 1002	2,74
10 mm	3/8"	PH 1003	4,28

## Auto. Pol.-codo giratorio M BSPT cónico

Push-in Pol. - elbow adjustable M BSPT tapered

Push-in Pol. - coude tournant M BSPT conique

Automatico maschio girevole



PIPE TUBO	THREAD ROSCA	Part nº Referencia	€
4 mm	1/8"	PL 0401	0,98
4 mm	1/4"	PL 0402	0,98
6 mm	1/8"	PL 0601	0,98
6 mm	1/4"	PL 0602	1,17
6 mm	3/8"	PL 0603	1,60
8 mm	1/8"	PL 0801	1,24
8 mm	1/4"	PL 0802	1,24
8 mm	3/8"	PL 0803	1,40
10 mm	1/4"	PL 1002	1,45
10 mm	3/8"	PL 1003	1,53
10 mm	1/2"	PL 1004	2,44
12 mm	3/8"	PL 1203	2,37
12 mm	1/2"	PL 1204	2,50

## Auto. Pol.-codo giratorio cuerpo metálico M BSPT cónico

Push-in Pol. - elbow adjustable metallic body M BSPT tapered

Push-in Pol. - coude ajustable corps metallique M BSPT conique

Automatico maschio girevole conico



PIPE TUBO	THREAD ROSCA	Part nº Referencia	€
6 mm	1/8"	50110 6 1/8	4,53
8 mm	1/4"	50110 8 1/4	3,71
10 mm	1/4"	50110 10 1/4	6,85

Hasta fin de existencias. / Until end of stock. / Jusqu'à la fin du stock. / Fino ad esaurimento scorta.

## Auto. Pol.-codo giratorio prolongado M BSPT cónico

Push-in Pol. - elbow adjustable extensor M BSPT tapered

Push-in Pol. - coude tournant prolongé M BSPT conique

Automatico a 90 prolunga maschio girevole



PIPE TUBO	THREAD ROSCA	Part nº Referencia	€
4 mm	1/8"	PLL 0401	1,35
4 mm	1/4"	PLL 0402	2,01
6 mm	1/8"	PLL 0601	2,14
6 mm	1/4"	PLL 0602	2,28
8 mm	1/8"	PLL 0801	2,56
8 mm	3/8"	PLL 0803	3,20
10 mm	1/4"	PLL 1002	4,47

## Auto. Pol.-T central giratorio M BSPT cónico

Push-in Pol. - Tee central adjustable M BSPT tapered

Push-in Pol. - T central tournant M BSPT conique

Automatico T maschio girevole centrale



PIPE TUBO	THREAD ROSCA	Part nº Referencia	€
4 mm	1/8"	PT 0401	1,55
6 mm	1/8"	PT 0601	1,76
6 mm	1/4"	PT 0602	1,85
8 mm	1/8"	PT 0801	1,98
8 mm	1/4"	PT 0802	2,09
10 mm	1/4"	PT 1002	2,10
10 mm	3/8"	PT 1003	2,58
12 mm	3/8"	PT 1203	2,83
12 mm	1/2"	PT 1204	3,15

# Conexión Push-in automático

*Push-in Fittings*

*Raccords Automatiques Push-in*

*Raccordi automatici Push-in*

## Auto. Pol.-T lateral giratorio M BSPT cónico

*Push-in Pol. - Tee lateral adjustable M BSPT tapered*

*Push-in Pol. - T lateral tournant M BSPT conique*

*Automatico T maschio girevole laterale*



PIPE TUBO	THREAD ROSCA	Part n° Referencia	€
4 mm	1/8"	PST 0401	1,86
6 mm	1/8"	PST 0601	1,84
6 mm	1/4"	PST 0602	1,84
8 mm	1/8"	PST 0801	2,07
8 mm	1/4"	PST 0802	3,06
10 mm	1/4"	PST 1002	4,05
10 mm	3/8"	PST 1003	4,47
12 mm	3/8"	PST 1203	2,82
12 mm	1/2"	PST 1204	3,11

## Auto. Pol.-Y central M BSPT cónico/M métrico

*Push-in Pol. - Y central M BSPT tapered/M metric*

*Push-in Pol. - Y central M BSPT conique /M métrique*

*Automatico automatico a Y maschio girevole centrale*



PIPE TUBO	THREAD ROSCA	Part n° Referencia	€
4 mm	1/8"	PWT 0401	2,02
4 mm	1/4"	PWT 0402	2,57
4 mm	M5	PWT 04M5	2,02
6 mm	1/8"	PWT 0601	2,32
6 mm	1/4"	PWT 0602	2,82
8 mm	1/8"	PWT 0801	2,70
8 mm	1/4"	PWT 0802	3,06
10 mm	1/4"	PWT 1002	4,05
10 mm	3/8"	PWT 1003	4,47
12 mm	3/8"	PWT 1203	5,68
12 mm	1/2"	PWT 1204	6,21

## Auto. Pol.-múltiple intermedio M BSPT cónico

*Push-in Pol.-multiple union M BSPT tapered*

*Push-in Pol.-intermédiaire multiple M BSPTconique*

*Automatico maschio con uscite multiple*



PIPE TUBO	THREAD ROSCA	Part n° Referencia	€
6 - 4 mm	1/8"	PKD 060401	3,74
8 - 4 mm	1/4"	PKD 080402	4,11
8 - 6 mm	1/4"	PKD 080602	4,13
10 - 8 mm	3/8"	PKD 100803	5,11

## Auto. Pol.-M BSP cilíndrico/M métrico

*Push-in Pol. - M BSP parallel/M metric*

*Push-in Pol. - coude tournant M BSP cylindrique /M métrique*

*Automatico diritto maschio*



PIPE TUBO	THREAD ROSCA	Part n° Referencia	€
4 mm	1/8"	PCCI 0401	0,87
4 mm	1/4"	PCCI 0402	1,02
4 mm	M5	PCCI 04M5	0,87
6 mm	1/8"	PCCI 0601	1,02
6 mm	1/4"	PCCI 0602	1,02
6 mm	3/8"	PCCI 0603	1,60
8 mm	1/8"	PCCI 0801	1,02
8 mm	1/4"	PCCI 0802	1,09
8 mm	3/8"	PCCI 0803	1,60
10 mm	1/4"	PCCI 1002	1,60
10 mm	3/8"	PCCI 1003	1,67
10 mm	1/2"	PCCI 1004	2,54
12 mm	1/4"	PCCI 1202	1,89
12 mm	3/8"	PCCI 1203	2,25
12 mm	1/2"	PCCI 1204	2,54

## Auto. Pol.-H BSP cilíndrico

*Push-in Pol. - F BSP parallel*

*Push-in Pol. - F BSP cilindrique*

*Automatico diritto femmina*



PIPE TUBO	THREAD ROSCA	Part n° Referencia	€
4 mm	1/8"	PCF 0401	1,24
6 mm	1/8"	PCF 0601	1,24
6 mm	1/4"	PCF 0602	1,25
8 mm	1/8"	PCF 0801	1,24
8 mm	1/4"	PCF 0802	1,28
10 mm	1/4"	PCF 1002	1,50
12 mm	3/8"	PCF 1203	2,25

# Conexión Push-in automático

Push-in Fittings

Raccords Automatiques Push-in

Raccordi automatici Push-in

## Auto. Pol.-codo orientable M BSP cilíndrico/M métrico

Push-in Pol. - elbow banjo M BSP parallel/M metric

Push-in Pol. - coude orientable M BSP cylindrique /M métrique

Automatico orientable a 90



PIPE TUBO	THREAD ROSCA	Part nº Referencia	€
4 mm	1/8"	PHCI 0401	4,49
4 mm	M5	PHCI 04M5	1,64
6 mm	1/8"	PHCI 0601	4,61
6 mm	1/4"	PHCI 0602	5,31
8 mm	1/8"	PHCI 0801	2,10
8 mm	1/4"	PHCI 0802	5,38
8 mm	3/8"	PHCI 0803	7,09
10 mm	3/8"	PHCI 1003	3,74

## Auto. Pol.-codo giratorio M BSP cilíndrico/M métrico

Push-in Pol. - elbow adjustable M BSP parallel/M metric

Push-in Pol. - coude tournant M BSP cylindrique /M métrique

Automatico maschio a 90 girevole



PIPE TUBO	THREAD ROSCA	Part nº Referencia	€
4 mm	1/8"	PLCI 0401	1,09
4 mm	1/4"	PLCI 0402	1,31
4 mm	M5	PLCI 04M5	1,09
6 mm	1/8"	PLCI 0601	1,31
6 mm	1/4"	PLCI 0602	1,53
6 mm	3/8"	PLCI 0603	1,67
6 mm	M5	PLCI 06M5	1,31
8 mm	1/8"	PLCI 0801	1,53
8 mm	1/4"	PLCI 0802	1,74
8 mm	3/8"	PLCI 0803	1,74
10 mm	1/4"	PLCI 1002	1,74
10 mm	3/8"	PLCI 1003	1,89
10 mm	1/2"	PLCI 1004	2,98
12 mm	1/4"	PLCI 1202	2,83
12 mm	3/8"	PLCI 1203	2,98
12 mm	1/2"	PLCI 1204	3,20

## Auto. Pol.-codo giratorio cuerpo metálico M BSP cilíndrico/M métrico

Push-in Pol. - elbow adjustable metallic body M BSP parallel/M metric

Push-in Pol. - coude tournant corps métallique M BSP cylindrique /M métrique

Automatico a 90 maschio girevole



PIPE TUBO	THREAD ROSCA	Part nº Referencia	€
4 mm	1/8"	50115 4 1/8	4,27
4 mm	M5	50115 4 M5	4,22
6 mm	1/8"	50115 6 1/8	4,35
6 mm	1/4"	50115 6 1/4	4,68
6 mm	M5	50115 6 M5	4,22
8 mm	1/8"	50115 8 1/8	4,99
8 mm	1/4"	50115 8 1/4	5,21
8 mm	3/8"	50115 8 3/8	6,34
10 mm	1/4"	50115 10 1/4	6,57
10 mm	3/8"	50115 10 3/8	7,25
10 mm	1/2"	50115 10 1/2	8,17
12 mm	3/8"	50115 12 3/8	8,32
12 mm	1/2"	50115 12 1/2	9,41

## Auto. Pol.-codo microrregulador p/cilindro M BSP cilíndrico/M métrico

Push-in Pol. - elbow speed controller for cylinder M BSP parallel/M metric

Push-in Pol. - coude micro-regulateur M BSP cylindrique /M métrique

Microregolatore per cilindro



PIPE TUBO	THREAD ROSCA	Part nº Referencia	€
4 mm	1/8"	SCL 0401	3,57
4 mm	1/4"	SCL 0402	3,85
4 mm	M5	SCL 04M5	3,50
6 mm	1/8"	SCL 0601	3,77
6 mm	1/4"	SCL 0602	3,85
6 mm	3/8"	SCL 0603	5,50
6 mm	M5	SCL 06M5	3,70
8 mm	1/8"	SCL 0801	3,77
8 mm	1/4"	SCL 0802	3,85
8 mm	3/8"	SCL 0803	5,50
10 mm	1/4"	SCL 1002	4,65
10 mm	3/8"	SCL 1003	6,77
12 mm	1/4"	SCL 1202	5,19
12 mm	3/8"	SCL 1203	7,02
12 mm	1/2"	SCL 1204	10,42

## Auto. Pol.-T central giratorio M BSP cilíndrico

Push-in Pol. - Tee central adjustable M BSP parallel

Push-in Pol. - T central tournant M BSP cylindrique

Automatico T girevole centrale



PIPE TUBO	THREAD ROSCA	Part nº Referencia	€
4 mm	1/8"	PTCI 0401	1,23
6 mm	1/8"	PTCI 0601	4,51
8 mm	1/8"	PTCI 0801	1,69
8 mm	3/8"	PTCI 0803	3,11
10 mm	1/4"	PTCI 1002	7,63
10 mm	3/8"	PTCI 1003	7,92
12 mm	3/8"	PTCI 1203	4,33

## Auto. Pol.-T central giratorio cuerpo metálico M BSP cilíndrico

Push-in Pol. - Tee central adjustable metallic body M BSP parallel

Push-in Pol. - T central tournant corps métallique M BSP cylindrique

Automatico a T maschio girevole centrale



PIPE TUBO	THREAD ROSCA	Part nº Referencia	€
4 mm	1/8"	50215 4 1/8	6,44
4 mm	1/4"	50215 4 1/4	6,89
6 mm	1/8"	50215 6 1/8	6,46
6 mm	1/4"	50215 6 1/4	6,88
8 mm	1/8"	50215 8 1/8	7,87
8 mm	1/4"	50215 8 1/4	8,05
10 mm	1/4"	50215 10 1/4	10,44
10 mm	3/8"	50215 10 3/8	10,88
12 mm	3/8"	50215 12 3/8	12,10
12 mm	1/2"	50215 12 1/2	13,48

# Conexión Push-in automático

Push-in Fittings

Raccords Automatiques Push-in

Raccordi automatici Push-in

## Auto. Pol.-T lateral giratorio M BSP cilíndrico

Push-in Pol. - T lateral adjustable M BSP parallel

Push-in Pol. - T lateral tournant M BSP cylindrique

Automatico T girevole laterale



PIPE TUBO	THREAD ROSCA	Part nº Referencia	€
4 mm	1/8"	PSTCI 0401	5,52
6 mm	1/8"	PSTCI 0601	5,59
6 mm	1/4"	PSTCI 0602	5,96
8 mm	1/8"	PSTCI 0801	6,80
8 mm	1/4"	PSTCI 0802	4,12
10 mm	1/4"	PSTCI 1002	9,47
10 mm	3/8"	PSTCI 1003	9,82
12 mm	3/8"	PSTCI 1203	10,63

## Auto. Pol.-T lateral giratorio cuerpo metálico M BSP cilíndrico

Push-in Pol. - T lateral adjustable metallic body M BSP parallel

Push-in Pol. - T lateral tournant corps métallique M BSP cylindrique

Automatico a T maschio girevole laterale



PIPE TUBO	THREAD ROSCA	Part nº Referencia	€
4 mm	1/8"	50225 4 1/8	6,44
6 mm	1/8"	50225 6 1/8	6,49
6 mm	1/4"	50225 6 1/4	6,89
8 mm	1/8"	50225 8 1/8	7,87
8 mm	1/4"	50225 8 1/4	8,05
10 mm	1/4"	50225 10 1/4	10,54
10 mm	3/8"	50225 10 3/8	10,88
12 mm	3/8"	50225 12 3/8	12,10

## Auto. Pol.-intermedio

Push-in Pol.-union

Union à piquage

Automatico intermedio



PIPE TUBO	PIPE TUBO	Part nº Referencia	€
6 mm	4 mm	PG 0604	0,85
8 mm	6 mm	PG 0806	1,15
10 mm	8 mm	PG 1008	1,27
12 mm	10 mm	PG 1210	1,67
4 mm	4 mm	PUC 04	0,74
6 mm	6 mm	PUC 06	0,82
8 mm	8 mm	PUC 08	0,89
10 mm	10 mm	PUC 10	1,04
12 mm	12 mm	PUC 12	1,20

## Auto. Pol.-intermedio pasatabique tuerca BSP

Push-in Pol.-union bulkhead w/BSP nut

Piquage passe-cloison

Automatico intermedio passaparete



PIPE TUBO	Part nº Referencia	€
4 mm	50050N 4	6,35
6 mm	50050N 6	7,08
8 mm	50050N 8	7,77
10 mm	50050N 10	10,20
12 mm	50050N 12	12,22

## Auto. Pol.-regulador en línea

Push-in Pol.-straight speed controller

Régulateur de débit en ligne

Regolatore di flusso in linea



PIPE TUBO	Part nº Referencia	€
4 mm	SCU 04	4,82
6 mm	SCU 06	4,91
8 mm	SCU 08	5,25
10 mm	SCU 10	6,47

## Auto. Pol.-reductor insertable

Push-in Pol.-plug-in reducer

Piquage de réduction

Automatico di riduzione



PIPE TUBO	PIPE TUBO	Part nº Referencia	€
6 mm	4 mm	PR 0604	1,36
8 mm	4 mm	PR 0804	1,47
8 mm	6 mm	PR 0806	1,47
10 mm	6 mm	PR 1006	1,63
10 mm	8 mm	PR 1008	1,65
12 mm	8 mm	PR 1208	1,96
12 mm	10 mm	PR 1210	1,96

## Auto. Pol.-intermedio cuerpo metálico

Push-in Pol.-union metallic body

Union simple à piquage

Automatico intermedio



PIPE TUBO	Part nº Referencia	€
4 mm	50040 4	2,50
6 mm	50040 6	2,97
8 mm	50040 8	3,68
10 mm	50040 10	6,65
12 mm	50040 12	6,96

## Auto. Pol.-intermedio pasatabique tuerca métrica

Push-in Pol.-union bulkhead w/metric nut

Piquage passe-cloison

Automatico intermedio passaparete



PIPE TUBO	THREAD ROSCA	Part nº Referencia	€
4 mm	M12	PMM 04	2,57
6 mm	M14	PMM 06	2,66
8 mm	M16	PMM 08	2,69
10 mm	M20	PMM 10	3,71
12 mm	M22	PMM 12	3,83

# Conexión Push-in automático

Push-in Fittings

Raccords Automatiques Push-in

Raccordi automatici Push-in

## Auto. Pol.-cuerpo orientable metálico

Push-in Pol.-banjo body metallic body

Banjo simple à piquage

Automatico orientabile



PIPE TUBO	THREAD ROSCA	Part nº Referencia	€
4 mm	M5	50500 4 M5	3,63
4 mm	M6	50500 4 M6	3,63
4 mm	1/8"	50500 4 1/8	3,75
6 mm	M5	50500 6 M5	3,75
6 mm	M6	50500 6 M6	3,75
6 mm	1/8"	50500 6 1/8	3,93
6 mm	1/4"	50500 6 1/4	4,22
8 mm	1/8"	50500 8 1/8	4,37
8 mm	1/4"	50500 8 1/4	4,57
8 mm	3/8"	50500 8 3/8	5,16
10 mm	1/4"	50500 10 1/4	5,19
10 mm	3/8"	50500 10 3/8	5,67
12 mm	3/8"	50500 12 3/8	7,20
12 mm	1/2"	50500 12 1/2	8,79

## Tornillo orientable simple M BSP cilíndrico/M métrico

Simple banjo bolt M BSP parallel/M metric

Vis pour banjo simple

Bullone per automatico orientabile



THREAD ROSCA	Part nº Referencia	€
M5	51410 M5	1,45
M6	51410 M6	1,56
M12x1.5	51410 M12	2,51
1/8"	51410 1/8	1,90
1/4"	51410 1/4	2,42
3/8"	51410 3/8	3,48
1/2"	51410 1/2	6,02

## Tornillo orientable doble M cilíndrico BSP

Double banjo bolt M BSP parallel

Vis pour banjo double

Bullone forato doppio



THREAD ROSCA	Part nº Referencia	€
1/8"	51420 1/8	2,62
1/4"	51420 1/4	3,78
3/8"	51420 3/8	5,70
1/2"	51420 1/2	9,68

## Auto. Pol.-codo intermedio

Push-in Pol.-elbow union

Coude d'union à piquage

Automatico intermedio a 90



PIPE TUBO	Part nº Referencia	€
4 mm	PUL 04	0,74
6 mm	PUL 06	0,82
8 mm	PUL 08	0,89
10 mm	PUL 10	1,04
12 mm	PUL 12	1,20

## Auto. Pol.-codo intermedio cuerpo metálico

Push-in Pol.-elbow union metallic body

Coude d'union à piquage

Automatico a 90 intermedio



PIPE TUBO	Part nº Referencia	€
4 mm	50130 4	4,31
6 mm	50130 6	4,38
8 mm	50130 8	5,12
10 mm	50130 10	6,34
12 mm	50130 12	8,28

## Auto. Pol.-codo insertable

Push-in Pol.-elbow plug-in

Coude à piquage lisse

Automatico estremita tubolare



PIPE TUBO	Part nº Referencia	€
4 mm	PLJ 04	1,83
6 mm	PLJ 06	2,31
8 mm	PLJ 08	2,93
10 mm	PLJ 10	2,65
12 mm	PLJ 12	3,10

## Auto. Pol.-T intermedio

Push-in Pol.-Tee union

Piquage en T intermédiaire

Automatico T intermedio



PIPE TUBO	Part nº Referencia	€
4 mm	PUT 04	0,84
6 mm	PUT 06	0,91
8 mm	PUT 08	1,02
10 mm	PUT 10	1,50
12 mm	PUT 12	2,16

# Conexión Push-in automático

Push-in Fittings

Raccords Automatiques Push-in

Raccordi automatici Push-in

## Auto. Pol.-T intermedio cuerpo metálico

Push-in Pol.-Tee union metallic body

Té à piquage

Automatico a T intermedio



PIPE TUBO	Part nº Referencia	€
4 mm	50230 4	6,32
6 mm	50230 6	6,72
8 mm	50230 8	7,77
10 mm	50230 10	10,09
12 mm	50230 12	12,51

## Auto. Pol.-Y intermedio

Push-in Pol.-Y union

Piquage en Y

Automatico intermedio a Y



PIPE TUBO	Part nº Referencia	€
4 mm	4 mm PY 04	0,88
6 mm	6 mm PY 06	0,96
8 mm	8 mm PY 08	1,03
10 mm	10 mm PY 10	1,53
12 mm	12 mm PY 12	1,72

## Auto. Pol.-Y intermedio cuerpo metálico

Push-in Pol.-Y union metallic body

Piquage en Y

Automatico a Y intermedio



PIPE TUBO	Part nº Referencia	€
4 mm	50310 4	8,79
6 mm	50310 6	9,26
8 mm	50310 8	10,47

## Auto. Pol.-Y central insertable

Push-in Pol.-Y central plug-in

Piquage en Y simple lisse

Automatico a Y estremita tubolare centrale



PIPE TUBO	Part nº Referencia	€
6 - 4 mm	PWJ 0604	2,35
8 - 6 mm	PWJ 0806	2,62
10 - 8 mm	PWJ 1008	2,93
12 - 10 mm	PWJ 1210	3,78
4 mm	PYJ 04	2,33
6 mm	PYJ 06	2,33
8 mm	PYJ 08	2,62
10 mm	PYJ 10	2,93
12 mm	PYJ 12	3,78

## Auto. Pol.-cruz intermedio

Push-in Pol.-cross union

Croix à piquage

Automatico intermedio a croce



PIPE TUBO	Part nº Referencia	€
4 mm	PZA 04	1,48
6 mm	PZA 06	1,88
8 mm	PZA 08	2,20
10 mm	PZA 10	3,19
12 mm	PZA 12	3,83

## Auto. Pol.-múltiple intermedio

Push-in Pol.-Multiple union

Piquage multiple

Automatico intermedio con uscite multiple



PIPE TUBO	Part nº Referencia	€
6 - 4 mm	PKG 0604	2,01
8 - 4 mm	PKG 0804	2,65
10 - 6 mm	PKG 1006	3,29
10 - 8 mm	PKG 1008	3,29

## Tapón insertable para automático

Plug-Plug-in for Push-in

Piquage bouchon

Automatico tappo



PIPE TUBO	Part nº Referencia	€
4 mm	TAP 04	0,39
6 mm	TAP 06	0,51
8 mm	TAP 08	0,61
10 mm	TAP 10	0,69
12 mm	TAP 12	0,78

## Insertable para automático cuerpo metálico M BSP

Plug-in for Push-in M BSP

Adapteur mâle cylindrique

Adattatore maschio cilindrico



PIPE TUBO	THREAD ROSCA	Part nº Referencia	€
4 mm	1/8"	50600 4 1/8	1,48
6 mm	1/8"	50600 6 1/8	1,48
6 mm	1/4"	50600 6 1/4	1,95
8 mm	1/8"	50600 8 1/8	1,56
8 mm	1/4"	50600 8 1/4	2,12
8 mm	3/8"	50600 8 3/8	3,08
10 mm	1/4"	50600 10 1/4	2,22
10 mm	3/8"	50600 10 3/8	3,16
12 mm	1/4"	50600 12 1/4	2,35
12 mm	3/8"	50600 12 3/8	3,31



# Conexión Push-in automático

Push-in Fittings

Raccords Automatiques Push-in

Raccordi automatici Push-in

## Auto. Met.-M BSPT cónico

Push-in Met.-M BSPT tapered

Piquage droit mâle

Automatico diritto maschio



PIPE TUBO	THREAD ROSCA	Part n° Referencia	€
4 mm	1/8"	MPC 0401	1,81
4 mm	1/4"	MPC 0402	1,81
6 mm	1/8"	MPC 0601	1,87
6 mm	1/4"	MPC 0602	1,90
6 mm	3/8"	MPC 0603	2,47
8 mm	1/8"	MPC 0801	1,92
8 mm	1/4"	MPC 0802	1,95
8 mm	3/8"	MPC 0803	2,52
10 mm	1/8"	MPC 1001	2,89
10 mm	1/4"	MPC 1002	2,91
10 mm	3/8"	MPC 1003	3,08
10 mm	1/2"	MPC 1004	4,32

## Auto. Met.-codo giratorio M BSPT cónico

Push-in Met.-elbow adjustable M BSPT tapered

Equerre à piquage mâle tournant

Automatico maschio girevole



PIPE TUBO	THREAD ROSCA	Part n° Referencia	€
4 mm	1/8"	MPL 0401	3,08
4 mm	1/4"	MPL 0402	3,22
6 mm	1/8"	MPL 0601	4,25
6 mm	1/4"	MPL 0602	4,38
8 mm	1/8"	MPL 0801	5,07
8 mm	1/4"	MPL 0802	5,21
8 mm	3/8"	MPL 0803	5,41
10 mm	1/4"	MPL 1002	6,58
10 mm	3/8"	MPL 1003	6,79
10 mm	1/2"	MPL 1004	7,40

## Auto. Met.-M BSP cilíndrico/M métrico

Push-in Met.-M BSP parallel/M metric

Piquage droit mâle cylindrique

Automatico diritto maschio cilindrico



PIPE TUBO	THREAD ROSCA	Part n° Referencia	€
4 mm	M5	MPCCI 04M5	1,81
4 mm	1/8"	MPCCI 0401	1,82
4 mm	1/4"	MPCCI 0402	1,81
6 mm	1/8"	MPCCI 0601	1,87
6 mm	1/4"	MPCCI 0602	1,90
6 mm	3/8"	MPCCI 0603	2,47
8 mm	1/8"	MPCCI 0801	1,94
8 mm	1/4"	MPCCI 0802	1,95
8 mm	3/8"	MPCCI 0803	2,52
10 mm	1/4"	MPCCI 1002	2,91
10 mm	3/8"	MPCCI 1003	3,08
10 mm	1/2"	MPCCI 1004	4,32
12 mm	1/4"	MPCCI 1202	3,63
12 mm	3/8"	MPCCI 1203	3,90
12 mm	1/2"	MPCCI 1204	4,72

## Auto. Met.-codo orientable M BSP cilíndrico

Push-in Met.-elbow banjo M BSP parallel

Banjo simple à piquage mâle cylindrique

Automatico estremita tubolare a 90 cilindrico



PIPE TUBO	THREAD ROSCA	Part n° Referencia	€
6 mm	1/8"	MPHCI 0601	4,86
8 mm	1/4"	MPHCI 0802	7,04
10 mm	1/4"	MPHCI 1002	7,36

## Auto. Met.-codo giratorio M BSP cilíndrico/M métrico

Push-in Met.-elbow adjustable M BSP parallel/M metric

Equerre à piquage mâle tournant cylindrique

Automatico girevole cilindrico



PIPE TUBO	THREAD ROSCA	Part n° Referencia	€
4 mm	M5	MPLCI 04M5	3,07
4 mm	1/8"	MPLCI 0401	3,08
4 mm	1/4"	MPLCI 0402	3,22
6 mm	1/8"	MPLCI 0601	4,29
6 mm	1/4"	MPLCI 0602	4,38
6 mm	3/8"	MPLCI 0603	4,59
8 mm	1/8"	MPLCI 0801	5,07
8 mm	1/4"	MPLCI 0802	5,21
8 mm	3/8"	MPLCI 0803	5,41
10 mm	1/4"	MPLCI 1002	6,58
10 mm	3/8"	MPLCI 1003	6,79
12 mm	1/4"	MPLCI 1202	8,08
12 mm	3/8"	MPLCI 1203	8,36
12 mm	1/2"	MPLCI 1204	9,03

## Auto. Met.-H BSP cilíndrico

Push-in Met.-F BSP parallel

Piquage droit femelle cylindrique

Automatico diritto femmina cilindrico



PIPE TUBO	THREAD ROSCA	Part n° Referencia	€
4 mm	1/8"	MPCF 0401	2,30
6 mm	1/8"	MPCF 0601	2,37
6 mm	1/4"	MPCF 0602	2,47
8 mm	1/8"	MPCF 0801	2,54
8 mm	1/4"	MPCF 0802	2,52
10 mm	1/4"	MPCF 1002	3,00
12 mm	3/8"	MPCF 1203	4,72

## Conexión Push-in automático

*Push-in Fittings*

*Raccords Automatiques Push-in*

*Raccordi automatici Push-in*

### Auto. Met.-codo microrregulador p/cilindro M BSP cilíndrico

*Push-in Met.-elbow speed controller for cylinder M BSP parallel*

*Microrégulateur pour vérins cylindrique*

*Microregolatore cilindrico per cilindro*



PIPE TUBO	THREAD ROSCA	Part n° Referencia	€
4 mm	1/8"	MSCL 0401	9,03
4 mm	1/4"	MSCL 0402	11,83
6 mm	1/8"	MSCL 0601	9,03
6 mm	1/4"	MSCL 0602	11,83
6 mm	3/8"	MSCL 0603	17,81
8 mm	1/8"	MSCL 0801	9,03
8 mm	1/4"	MSCL 0802	11,83
8 mm	3/8"	MSCL 0803	17,81
10 mm	1/4"	MSCL 1002	11,83

### Auto. Met.-T central giratorio M BSP cilíndrico

*Push-in Met.-Tee central adjustable M BSP parallel*

*Té à piquage mâle tournant central cylindrique*

*Automatico T maschio girevole centrale cilindrico*



PIPE TUBO	THREAD ROSCA	Part n° Referencia	€
4 mm	1/8"	MPTCI 0401	4,11
6 mm	1/8"	MPTCI 0601	5,90
6 mm	1/4"	MPTCI 0602	6,03
8 mm	1/8"	MPTCI 0801	7,17
8 mm	1/4"	MPTCI 0802	7,32
8 mm	3/8"	MPTCI 0803	7,59
10 mm	1/4"	MPTCI 1002	8,79
10 mm	3/8"	MPTCI 1003	9,06
12 mm	3/8"	MPTCI 1203	9,75

### Auto. Met.-T lateral giratorio M BSP cilíndrico

*Push-in Met.-Tee lateral adjustable M BSP parallel*

*Té à piquage mâle tournant latéral cylindrique*

*Automatico T maschio girevole laterale cilindrico*



PIPE TUBO	THREAD ROSCA	Part n° Referencia	€
4 mm	1/8"	MPSTCI 0401	4,11
4 mm	1/4"	MPSTCI 0402	4,38
6 mm	1/8"	MPSTCI 0601	5,90
6 mm	1/4"	MPSTCI 0602	6,03
6 mm	3/8"	MPSTCI 0603	6,29
8 mm	1/8"	MPSTCI 0801	7,17
8 mm	1/4"	MPSTCI 0802	7,32
8 mm	3/8"	MPSTCI 0803	7,59
10 mm	1/4"	MPSTCI 1002	8,79

# Conexión Push-in automático

Push-in Fittings

Raccords Automatiques Push-in

Raccordi automatici Push-in

## Auto. Met.-intermedio

Push-in Met.-union

Union à piquage

Automatico intermedio

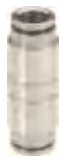

PIPE TUBO	Part nº Referencia	€
4 mm	MPUC 04	2,31
6 mm	MPUC 06	2,51
8 mm	MPUC 08	3,38
10 mm	MPUC 10	4,61
12 mm	MPUC 12	5,47

## Auto. Met.-intermedio pasatabique tuerca métrica

Push-in Met.-union bulkhead w/metric nut

Piquage passe-cloison cylindrique

Automatico intermedio passaparete cilindrico



PIPE TUBO	Part nº Referencia	€
4 mm	MPMM 04	4,28
6 mm	MPMM 06	4,38
8 mm	MPMM 08	5,51
10 mm	MPMM 10	6,75
12 mm	MPMM 12	7,88

## Auto. Met.-codo intermedio

Push-in Met.-elbow union

Coude d'union à piquage

Automatico intermedio a 90



PIPE TUBO	Part nº Referencia	€
4 mm	MPUL 04	2,52
6 mm	MPUL 06	2,78
8 mm	MPUL 08	3,72
10 mm	MPUL 10	5,03

## Auto. Met.-T intermedio

Push-in Met.-Tee union

Piquage en Té intermédiaire

Automatico T intermedio



PIPE TUBO	Part nº Referencia	€
4 mm	MPUT 04	3,30
6 mm	MPUT 06	3,98
8 mm	MPUT 08	5,52
10 mm	MPUT 10	7,56
12 mm	MPUT 12	8,64

## Auto. Met.-Y intermedio

Push-in Met.-Y union

Piquage en Y

Automatico intermedio a Y



PIPE TUBO	Part nº Referencia	€
4 mm	MPY 04	4,52
6 mm	MPY 06	5,45
8 mm	MPY 08	7,54
10 mm	MPY 10	10,28
12 mm	MPY 12	11,92

## Tapón insertable para automático

Plug

Piquage bouchon

Automatico tappo



PIPE TUBO	Part nº Referencia	€
4 mm	TAP 04	0,39
6 mm	TAP 06	0,51
8 mm	TAP 08	0,61
10 mm	TAP 10	0,69
12 mm	TAP 12	0,78

## Insertable para automático cuerpo metálico M BSP

Nipple

Adapteur mâle cylindrique

Adattatore maschio cilindrico



PIPE TUBO	THREAD ROSCA	Part nº Referencia	€
4 mm	1/8"	50600 4 1/8	1,48
6 mm	1/8"	50600 6 1/8	1,48
6 mm	1/4"	50600 6 1/4	1,95
8 mm	1/8"	50600 8 1/8	1,56
8 mm	1/4"	50600 8 1/4	2,12
8 mm	3/8"	50600 8 3/8	3,08
10 mm	1/4"	50600 10 1/4	2,22
10 mm	3/8"	50600 10 3/8	3,16
12 mm	1/4"	50600 12 1/4	2,35
12 mm	3/8"	50600 12 3/8	3,31

## Conexión con espiga

*Hose tail-M BSPT tapered*

*Raccords avec embout*

*Raccordi con embout*

### Espiga-M BSPT cónico

*Hose tail-M BSPT tapered*

*Douille mâle conique*

*Inserto maschio conico*



PIPE TUBO	THREAD ROSCA	Part n° Referencia	€
6 mm	1/8"	3040 6 1/8	0,81
6 mm	1/4"	3040 6 1/4	1,24
7 mm	1/8"	3040 7 1/8	1,08
7 mm	1/4"	3040 7 1/4	1,37
8 mm	1/8"	3040 8 1/8	0,87
8 mm	1/4"	3040 8 1/4	1,55
9 mm	1/8"	3040 9 1/8	1,28
9 mm	1/4"	3040 9 1/4	1,37
9 mm	3/8"	3040 9 3/8	1,70
9 mm	1/2"	3040 9 1/2	3,04
10 mm	1/4"	3040 10 1/4	1,67
10 mm	3/8"	3040 10 3/8	1,82
10 mm	1/2"	3040 10 1/2	3,04
12 mm	1/4"	3040 12 1/4	1,53
12 mm	3/8"	3040 12 3/8	2,17
12 mm	1/2"	3040 12 1/2	2,99
14 mm	3/8"	3040 14 3/8	1,86
14 mm	1/2"	3040 14 1/2	3,03
16 mm	3/8"	3040 16 3/8	2,37
16 mm	1/2"	3040 16 1/2	3,35

### Espiga doble

*Doble hose tail connector*

*Douille double jonction*

*Inserto doppio*



PIPE TUBO	Part n° Referencia	€
6 mm	3055 6	0,44
8 mm	3055 8	0,58
10 mm	3055 10	0,73

### Espiga-M BSP cilíndrico

*Hose tail-M BSP parallel*

*Douille mâle cylindrique*

*Inserto maschio cilindrico*



PIPE TUBO	THREAD ROSCA	Part n° Referencia	€
7 mm	1/8"	3045 7 1/8	0,94
7 mm	1/4"	3045 7 1/4	1,38
8 mm	1/8"	3045 8 1/8	0,94
9 mm	1/8"	3045 9 1/8	1,16
9 mm	1/4"	3045 9 1/4	1,53
9 mm	3/8"	3045 9 3/8	2,11
12 mm	1/4"	3045 12 1/4	1,89
12 mm	3/8"	3045 12 3/8	2,25
12 mm	1/2"	3045 12 1/2	3,63

### Espiga-H BSP cilíndrico

*Hose tail-F BSP parallel*

*Douille femelle*

*Inserto femmina*



PIPE TUBO	THREAD ROSCA	Part n° Referencia	€
6 mm	1/8"	3050 6 1/8	1,02
7 mm	1/8"	3050 7 1/8	1,02
7 mm	1/4"	3050 7 1/4	1,41
8 mm	1/4"	3050 8 1/4	1,53
9 mm	1/4"	3050 9 1/4	1,67
9 mm	3/8"	3050 9 3/8	2,11
10 mm	3/8"	3050 10 3/8	2,11
12 mm	3/8"	3050 12 3/8	2,25
12 mm	1/2"	3050 12 1/2	3,41

### Espiga macho cilíndrico sin junta

*Male hose adapter parallel without o'ring*

*Douille mâle cylindrique sans joint*

*Inserto maschio cilindrico senza giunta*



PIPE TUBO	THREAD ROSCA	Part n° Referencia	€
9 mm	3/8"	3045A 9 3/8	2,23
12 mm	1/4"	3045A 12 1/4	2,00
12 mm	1/2"	3045A 12 1/2	3,85

Hasta fin de existencias. / Until end of stock / Jusqu'à la fin du stock. / Fino ad esaurimento scorta.

# Conexión Push-on

Push-on Fittings  
Raccords Push-on  
Raccordi Push-on

## Push-on-M BSPT cónico

Push-on-M BSPT tapered

Raccord droit mâle conique

Raccordo maschio conico



PIPE TUBO	THREAD ROSCA	Part n° Referencia	€
4/2,7 mm	1/8"	1000 4/2.7 1/8	1,63
6/4 mm	1/8"	1000 6/4 1/8	1,41
6/4 mm	1/4"	1000 6/4 1/4	1,68
6/4 mm	3/8"	1000 6/4 3/8	2,45
8/6 mm	1/8"	1000 8/6 1/8	1,87
8/6 mm	1/4"	1000 8/6 1/4	1,79
8/6 mm	3/8"	1000 8/6 3/8	2,54
8/6 mm	1/2"	1000 8/6 1/2 *	3,61
10/8 mm	1/4"	1000 10/8 1/4	2,34
10/8 mm	3/8"	1000 10/8 3/8	2,78
10/8 mm	1/2"	1000 10/8 1/2	3,86
12/10 mm	3/8"	1000 12/10 3/8	2,95
12/10 mm	1/2"	1000 12/10 1/2	4,05

## Push-on-giratorio M BSPT cónico

Push-on-adjustable M BSPT tapered

Raccord droit mâle tournant conique

Raccordo maschio conico girevole



PIPE TUBO	THREAD ROSCA	Part n° Referencia	€
6/4 mm	1/8"	1010 6/4 1/8	3,56
6/4 mm	1/4"	1010 6/4 1/4	3,87
8/6 mm	1/8"	1010 8/6 1/8	3,78
8/6 mm	1/4"	1010 8/6 1/4	4,17
10/8 mm	1/4"	1010 10/8 1/4	4,69
12/8 mm	3/8"	1010 12/8 3/8	6,44
12/10 mm	3/8"	1010 12/10 3/8	6,44

## Push-on-codo M BSPT cónico

Push-on-elbow M BSPT tapered

Raccord coudé mâle conique

Raccordo a 90 maschio conico



PIPE TUBO	THREAD ROSCA	Part n° Referencia	€
4/2,7 mm	1/8"	1100 4/2.7 1/8	3,18
6/4 mm	1/8"	1100 6/4 1/8	2,35
6/4 mm	1/4"	1100 6/4 1/4	2,51
6/4 mm	3/8"	1100 6/4 3/8	3,33
8/6 mm	1/8"	1100 8/6 1/8	2,54
8/6 mm	1/4"	1100 8/6 1/4	2,77
8/6 mm	3/8"	1100 8/6 3/8	3,16
8/6 mm	1/2"	1100 8/6 1/2	6,02
10/8 mm	1/4"	1100 10/8 1/4	3,36
10/8 mm	3/8"	1100 10/8 3/8	3,83
10/8 mm	1/2"	1100 10/8 1/2	5,87
12/10 mm	3/8"	1100 12/10 3/8	4,76
10/12 mm	1/2"	1100 12/10 1/2	6,44

## Push-on-codo giratorio M BSPT cónico

Push-on-elbow adjustable M BSPT tapered

Raccord coudé tournant mâle conique

Raccordo a 90 maschio conico girevole



PIPE TUBO	THREAD ROSCA	Part n° Referencia	€
4/2,7 mm	1/8"	1110 4/2.7 1/8	3,98
6/4 mm	1/8"	1110 6/4 1/8	3,98
6/4 mm	1/4"	1110 6/4 1/4	4,61
8/6 mm	1/8"	1110 8/6 1/8	4,25
8/6 mm	1/4"	1110 8/6 1/4	4,76
10/8 mm	1/4"	1110 10/8 1/4	5,48

## Push-on-T central giratorio M BSPT cónico

Push-on-Tee central adjustable M BSPT tapered

Raccord en té avec tournant mâle central

Raccordo a T maschio conico girevole centrale



PIPE TUBO	THREAD ROSCA	Part n° Referencia	€
6/4 mm	1/8"	1210 6/4 1/8	5,48
6/4 mm	1/4"	1210 6/4 1/4	5,67
8/6 mm	1/8"	1210 8/6 1/8	5,48
8/6 mm	1/4"	1210 8/6 1/4	5,97
10/8 mm	1/4"	1210 10/8 1/4	7,41

## Push-on-T lateral M BSPT cónico

Push-on-Tee lateral M BSPT tapered

Raccord en té avec mâle conique latéral

Raccordo a Y laterale conico maschio



PIPE TUBO	THREAD ROSCA	Part n° Referencia	€
6/4 mm	1/8"	1220 6/4 1/8	3,45
6/4 mm	1/4"	1220 6/4 1/4	3,63
8/6 mm	1/8"	1220 8/6 1/8	3,87
8/6 mm	1/4"	1220 8/6 1/4	4,07
10/8 mm	1/4"	1220 10/8 1/4	5,16
10/8 mm	3/8"	1220 10/8 3/8	6,07
12/10 mm	3/8"	1220 12/10 3/8	7,43

# Conexión Push-on

Push-on Fittings  
Raccords Push-on  
Raccordi Push-on

## Push-on-M BSP cilíndrico/M métrico c/junta

Push-on-M BSP/M metric w/o ring parallel

Raccord droit mâle cylindrique

Raccordo maschio cilindrico con o-ring



PIPE TUBO	THREAD ROSCA	Part n° Referencia	€
4/2,7 mm	1/8"	1020 4/2.7 1/8	1,75
6/4 mm	1/8"	1020 6/4 1/8	1,95
6/4 mm	1/4"	1020 6/4 1/4	2,49
6/4 mm	3/8"	1020 6/4 3/8	3,13
6/4 mm	1/2"	1020 6/4 1/2	4,84
8/6 mm	1/8"	1020 8/6 1/8	2,19
8/6 mm	1/4"	1020 8/6 1/4	2,24
8/6 mm	3/8"	1020 8/6 3/8	3,11
8/6 mm	1/2"	1020 8/6 1/2	4,76
10/8 mm	1/4"	1020 10/8 1/4	2,89
10/8 mm	3/8"	1020 10/8 3/8	3,31
10/8 mm	1/2"	1020 10/8 1/2	5,23
12/10 mm	3/8"	1020 12/10 3/8	3,72
12/10 mm	1/2"	1020 12/10 1/2	5,70
6/4 mm	M5	1021 6/4 M5	1,63
6/4 mm	M6	1021 6/4 M6	1,63

## Push-on-H BSP cilíndrico

Push-on-F BSP parallel

Raccord droit femelle

Raccordo femmina



PIPE TUBO	THREAD ROSCA	Part n° Referencia	€
6/4 mm	1/8"	1030 6/4 1/8	1,87
6/4 mm	1/4"	1030 6/4 1/4	2,09
6/4 mm	3/8"	1030 6/4 3/8	3,31
8/6 mm	1/8"	1030 8/6 1/8	1,90
8/6 mm	1/4"	1030 8/6 1/4	2,32
8/6 mm	3/8"	1030 8/6 3/8	3,42
8/6 mm	1/2"	1030 8/6 1/2	3,58
10/8 mm	1/4"	1030 10/8 1/4	2,59
10/8 mm	3/8"	1030 10/8 3/8	3,58
10/8 mm	1/2"	1030 10/8 1/2	4,52
12/10 mm	3/8"	1030 12/10 3/8	5,12

## Push-on-codo giratorio M BSP cilíndrico

Push-on-elbow adjustable M BSP parallel

Raccord coudé tournant mâle cylindrique

Raccordo a 90 maschio girevole



PIPE TUBO	THREAD ROSCA	Part n° Referencia	€
4/2,7 mm	1/8"	1115 4/2.7 1/8	3,98
6/4 mm	1/4"	1115 6/4 1/4	4,61
8/6 mm	1/8"	1115 8/6 1/8	4,25
8/6 mm	1/4"	1115 8/6 1/4	4,76
10/8 mm	1/4"	1115 10/8 1/4	5,48

## Push-on-codo H BSP cilíndrico

Push-on-elbow F BSP parallel

Raccord coudé femelle

Raccordo a 90 femmina fissa



PIPE TUBO	THREAD ROSCA	Part n° Referencia	€
6/4 mm	1/8"	1120 6/4 1/8	2,69
6/4 mm	1/4"	1120 6/4 1/4	3,28
8/6 mm	1/8"	1120 8/6 1/8	2,96
8/6 mm	1/4"	1120 8/6 1/4	3,55
10/8 mm	1/4"	1120 10/8 1/4	3,98
10/8 mm	3/8"	1120 10/8 3/8	6,88

## Push-on-T central giratorio M BSP cilíndrico

Push-on-Tee central adjustable M BSP parallel

Raccord en té avec tournant mâle central

Raccordo a T maschio girevole centrale



PIPE TUBO	THREAD ROSCA	Part n° Referencia	€
6/4 mm	1/8"	1215 6/4 1/8	5,73
6/4 mm	1/4"	1215 6/4 1/4	5,93
8/6 mm	1/8"	1215 8/6 1/8	5,73
8/6 mm	1/4"	1215 8/6 1/4	6,29
10/8 mm	1/4"	1215 10/8 1/4	7,80

## Tuerca para push-on rosca métrica

Nut for Push-on metric thread

Vis de fixation

Dado di fissaggio



PIPE TUBO	THREAD ROSCA	Part n° Referencia	€
4/2,7 mm	M6 x 0,5	1700 4/2.7	0,50
6/4 mm	M10 x 1	1700 6/4	0,54
8/6 mm	M12 x 1	1700 8/6	0,66
10/8 mm	M14 x 1	1700 10/8	0,89
12/10 mm	M16 x 1	1700 12/10	1,14

## Push-on-intermedio

Push-on-Union

Raccord intermédiaire

Raccordo intermedio



PIPE TUBO	PIPE TUBO	Part n° Referencia	€
4/2,7 mm	4/2,7 mm	1040 4/2.7	2,81
6/4 mm	6/4 mm	1040 6/4	2,59
8/6 mm	6/4 mm	1040 8/6 6/4	2,84
8/6 mm	8/6 mm	1040 8/6	2,80
10/8 mm	6/4 mm	1040 10/8 6/4	3,86
10/8 mm	8/6 mm	1040 10/8 8/6	4,05
10/8 mm	10/8 mm	1040 10/8	3,80
12/10 mm	12/10 mm	1040 12/10	6,17

# Conexión Push-on

Push-on Fittings  
Raccords Push-on  
Raccordi Push-on

Pipe and springs

Pneumatic fittings

Quick release couplings

## Push-on-intermedio pasatabique c/tuerca métrica

Push-on-Union bulkhead w/metric nut

Raccord passe-cloison

Raccordo passaparete



PIPE TUBO		THREAD ROSCA	Part n° Referencia	€
4/2,7 mm	4/2,7 mm	M6 x 0,7	1050 4/2.7	4,62
6/4 mm	6/4 mm	M10 x 3	1050 6/4	4,77
8/6 mm	6/4 mm	M12 x 1	1050 8/6X6/4	5,51
8/6 mm	8/6 mm	M12 x 1	1050 8/6	5,51
10/8 mm	6/4 mm	M14 x 1	1050 10/8X6/4	6,59
10/8 mm	8/6 mm	M14 x 1	1050 10/8X8/6	6,59
10/8 mm	10/8 mm	M14 x 1	1050 10/8	6,25
12/10 mm	12/10 mm	M16 x 3	1050 12/10	7,26

## Push-on-cuerpo orientable

Push-on-Banjo body

Banjo simple

Occhio orientabile semplice



PIPE TUBO	THREAD ROSCA	Part n° Referencia	€
4/2,7 mm	1/8"	1500 4/2.7 1/8	2,81
6/4 mm	1/8"	1500 6/4 1/8	3,11
6/4 mm	1/4"	1500 6/4 1/4	3,16
6/4 mm	3/8"	1500 6/4 3/8	4,02
6/4 mm	M6	1500 6/4 M6	2,54
8/6 mm	1/8"	1500 8/6 1/8	3,16
8/6 mm	1/4"	1500 8/6 1/4	3,31
8/6 mm	3/8"	1500 8/6 3/8	4,25
8/6 mm	1/2"	1500 8/6 1/2	5,48
10/8 mm	1/8"	1500 10/8 1/8	3,33
10/8 mm	1/4"	1500 10/8 1/4	3,60
10/8 mm	3/8"	1500 10/8 3/8	4,54
10/8 mm	1/2"	1500 10/8 1/2	5,73
12/10 mm	3/8"	1500 12/10 3/8	5,35
12/10 mm	1/2"	1500 12/10 1/2	6,64

## Push-on doble-Cuerpo orientable

Dual Push-on-Banjo body

Banjo double

Occhio orientabile doppio



PIPE TUBO	THREAD ROSCA	Part n° Referencia	€
4/2,7 mm	1/8"	1510 4/2.7 1/8	5,14
6/4 mm	1/8"	1510 6/4 1/8	5,16
6/4 mm	1/4"	1510 6/4 1/4	5,55
6/4 mm	3/8"	1510 6/4 3/8	6,44
8/6 mm	1/8"	1510 8/6 1/8	5,43
8/6 mm	1/4"	1510 8/6 1/4	5,43
8/6 mm	3/8"	1510 8/6 3/8	6,44
8/6 mm	1/2"	1510 8/6 1/2	7,80
10/8 mm	1/8"	1510 10/8 1/8	5,93
10/8 mm	1/4"	1510 10/8 1/4	6,02
10/8 mm	3/8"	1510 10/8 3/8	6,84
10/8 mm	1/2"	1510 10/8 1/2	8,20
12/10 mm	3/8"	1510 12/10 3/8	7,90
12/10 mm	1/2"	1510 12/10 1/2	9,21

## Tornillo orientable simple M BSP cilíndrico/M métrico

Simple banjo bolt M BSP parallel/M metric

Vis pour banjo simple

Bullone forato singolo



THREAD ROSCA	Part n° Referencia	€
M5	51410 M5	1,45
M6	51410 M6	1,56
M12x1.5	51410 M12	2,51
1/8"	51410 1/8	1,90
1/4"	51410 1/4	2,42
3/8"	51410 3/8	3,48
1/2"	51410 1/2	6,02

## Tornillo orientable doble M BSP cilíndrico

Double banjo bolt M BSP parallel

Vis pour banjo double

Bullone forato doppio



THREAD ROSCA	Part n° Referencia	€
1/8"	51420 1/8	2,62
1/4"	51420 1/4	3,78
3/8"	51420 3/8	5,70
1/2"	51420 1/2	9,68

# Conexión Push-on

Push-on Fittings  
Raccords Push-on  
Raccordi Push-on

## Push-on-codo intermedio

Push-on-elbow union

Raccord coudé intermédiaire

Raccordo a 90 intermedio



PIPE TUBO	Part nº Referencia	€
4/2,7 mm	1130 4/2.7	4,30
6/4 mm	1130 6/4	3,18
8/6 mm - 6/4 mm	1130 8/6 6/4	3,48
8/6 mm	1130 8/6	3,55
10/8 mm	1130 10/8	4,52
12/10 mm	1130 12/10	6,07

## Push-on-T intermedio

Push-on-Tee union

Raccord en té intermédiaire

Raccordo a T intermedio



PIPE TUBO	Part nº Referencia	€
4/2,7 mm	1230 4/2.7	4,81
6/4 mm	1230 6/4	4,14
8/6 mm	1230 8/6	4,61
10/8 mm	1230 10/8	6,02
12/10 mm	1230 12/10	8,35

## Push-on-cruz intermedio

Push-on-cross union

Raccord en croix intermédiaire

Raccordo a croce intermedio



PIPE TUBO	Part nº Referencia	€
6/4 mm	1300 6/4	6,76
8/6 mm	1300 8/6	7,77
10/8 mm	1300 10/8	9,73
12/10 mm	1300 12/10	13,90

## Push-on c/muelle-M BSPT cónico

Push-on w/nut+spring-M BSPT tapered

Raccord droit mâle conique avec ressort

Raccordo maschio conico+molla



PIPE TUBO	THREAD ROSCA	Part nº Referencia	€
6/4 mm	1/8"	1025 6/4 1/8	3,18
6/4 mm	1/4"	1025 6/4 1/4	3,41
8/6 mm	1/8"	1025 8/6 1/8	3,33
8/6 mm	1/4"	1025 8/6 1/4	3,45
8/6 mm	3/8"	1025 8/6 3/8	4,02
8/6 mm	1/2"	1025 8/6 1/2	5,23
10/8 mm	1/8"	1025 10/8 1/8	3,93
10/8 mm	1/4"	1025 10/8 1/4	3,95
10/8 mm	3/8"	1025 10/8 3/8	4,57
10/8 mm	1/2"	1025 10/8 1/2	5,75
12/10 mm	3/8"	1025 12/10 3/8	5,38
12/10 mm	1/2"	1025 12/10 1/2	6,44

## Push-on c/muelle-M BSP cilíndrico c/junta

Push-on w/nut+spring-M BSP w/o'ring parallel

Raccord droit mâle cylindrique avec ressort

Raccordo maschio +molla



PIPE TUBO	THREAD ROSCA	Part nº Referencia	€
6/4 mm	1/8"	1028 6/4 1/8	3,31
6/4 mm	1/4"	1028 6/4 1/4	3,78
6/4 mm	3/8"	1028 6/4 3/8	4,17
6/4 mm	1/2"	1028 6/4 1/2	5,51
8/6 mm	1/8"	1028 8/6 1/8	3,41
8/6 mm	1/4"	1028 8/6 1/4	3,78
8/6 mm	3/8"	1028 8/6 3/8	4,25
8/6 mm	1/2"	1028 8/6 1/2	5,40
10/8 mm	1/4"	1028 10/8 1/4	4,30
10/8 mm	3/8"	1028 10/8 3/8	4,69
10/8 mm	1/2"	1028 10/8 1/2	5,87
12/10 mm	3/8"	1028 12/10 3/8	6,02
12/10 mm	1/2"	1028 12/10 1/2	7,38

## Push-on c/muelle-giratorio M BSP cilíndrico c/junta

Push-on w/nut+spring-adjustable M BSP w/o'ring parallel

Raccord droit tournant mâle cylindrique avec ressort

Raccordo maschio cilindrico girevole con molla



PIPE TUBO	THREAD ROSCA	Part nº Referencia	€
6/4 mm	1/8"	1027 6/4 1/8	4,84
6/4 mm	1/4"	1027 6/4 1/4	5,25
8/6 mm	1/8"	1027 8/6 1/8	4,93
8/6 mm	1/4"	1027 8/6 1/4	5,40
10/8 mm	1/4"	1027 10/8 1/4	6,07
12/10 mm	3/8"	1027 12/10 3/8	7,87



# Conexión Push-on

Push-on Fittings  
Raccords Push-on  
Raccordi Push-on

## Push-on c/muelle-H BSP cilíndrico

Push-on w/nut+spring-F BSP parallel

Raccord droit femelle avec ressort

Raccordo femmina+molla



PIPE TUBO	THREAD ROSCA	Part n° Referencia	€
6/4 mm	1/8"	1035 6/4 1/8	3,36
6/4 mm	1/4"	1035 6/4 1/4	3,80
6/4 mm	3/8"	1035 6/4 3/8	4,77
8/6 mm	1/8"	1035 8/6 1/8	3,55
8/6 mm	1/4"	1035 8/6 1/4	4,14
8/6 mm	3/8"	1035 8/6 3/8	5,23
8/6 mm	1/2"	1035 8/6 1/2	5,87
10/8 mm	1/4"	1035 10/8 1/4	4,66
10/8 mm	3/8"	1035 10/8 3/8	5,43
10/8 mm	1/2"	1035 10/8 1/2	6,20
12/10 mm	3/8"	1035 12/10 3/8	6,64

## Push-on c/muelle-Tuerca de fijación métrica

Push-on w/nut+spring-fixing nut F Métrica parallel

Vis de fixation avec ressort

Dado di fissaggio con molla



PIPE TUBO	THREAD ROSCA	Part n° Referencia	€
6/4 mm	M10x3	1710 6/4	2,12
8/6 mm	M12x3	1710 8/6	2,42
10/8 mm	M14x3	1710 10/8	2,59
12/10 mm	M16x3	1710 12/10	3,63

# Adaptador

Adaptors  
Adaptateurs  
Adattatori

## Adaptador M BSPT cónico

Adaptor M BSPT tapered

Adapteur mâle-mâle conique

Maschio conico



THREAD ROSCA	Part nº Referencia	€
1/8"	2000 1/8	0,77
1/4"	2000 1/4	1,16
3/8"	2000 3/8	1,57
1/2"	2000 1/2	2,65
3/4"	2000 3/4	4,77
1"	2000 1	9,27

## Tapón reductor M BSPT cónico-H BSP cilíndrico

Reducer M BSPT-F BSP tapered

Bouchon réducteur conique

Tappo di riduzione conico



THREAD ROSCA	Part nº Referencia	€
1/4"-1/8"	2080 1/4 1/8	0,73
3/8"-1/8"	2080 3/8 1/8	1,40
3/8"-1/4"	2080 3/8 1/4	1,31
1/2"-1/8"	2080 1/2 1/8	2,47
1/2"-1/4"	2080 1/2 1/4	2,13
1/2"-3/8"	2080 1/2 3/8	1,74
3/4"-3/8"	2080 3/4 3/8	4,79
3/4"-1/2"	2080 3/4 1/2	3,30

## Reductor M BSPT cónico

Reducer M BSPT tapered

Réducteur mâle-mâle conique

Maschio conico di riduzione



THREAD ROSCA	Part nº Referencia	€
1/8"-1/4"	2020 1/8-1/4	1,28
1/8"-3/8"	2020 1/8 3/8	1,58
1/8"-1/2"	2020 1/8 1/2	2,83
1/4"-1/2"	2020 1/4 1/2	2,76
1/4"-3/8"	2020 1/4-3/8	1,57
3/8"-1/2"	2020 3/8-1/2	2,81
1/2"-3/4"	2020 1/2 3/4	4,36

## Prolongador M BSPT cónico - H BSP

Extensor M BSPT tapered-F BSP

Prolongateur conique

Prolunga conica



THREAD ROSCA	Part nº Referencia	€
1/8"-1/8"	2040 1/8 1/8	1,06
1/8"-1/4"	2040 1/8 1/4	1,43
1/8"-3/8"	2040 1/8 3/8	2,18
1/4"-1/4"	2040 1/4 1/4	1,61
1/4"-3/8"	2040 1/4 3/8	2,47
1/4"-1/2"	2040 1/4 1/2	3,05
3/8"-3/8"	2040 3/8 3/8	2,69
3/8"-1/2"	2040 3/8 1/2	3,56
1/2"-1/2"	2040 1/2 1/2	3,92
1/2"-3/4"	2040 1/2 3/4	6,69

## Prolongador pasatabique rosca métrica M BSPT cónico-H BSP cilíndrico

Extensor bulkhead w/metric Nut M BSPT tapered-F BSP

Passe-cloison

Passaparete



THREAD ROSCA	Part nº Referencia	€
M5	3060 M5	1,24
1/8"	3060 1/8	2,91
1/4"	3060 1/4	4,00
3/8"	3060 3/8	6,90
1/2"	3060 1/2	8,43

## Adaptador M BSP cilíndrico

Adaptor M BSP parallel

Adapteur mâle-mâle cylindrique

Adattatori cilindrico



THREAD ROSCA	Part nº Referencia	€
1/8"	2010 1/8	0,81
1/4"	2010 1/4	1,31
3/8"	2010 3/8	2,00
1/2"	2010 1/2	3,23
3/4"	2010 3/4	4,36
1"	2010 1	6,54

## Reductor M métrico/M BSP cilíndrico

Reducer M BSP parallel/M metric

Réducteur mâle-mâle cylindrique

Maschio cilindrico di riduzione



THREAD ROSCA	Part nº Referencia	€
M5-1/8"	2030 M5 1/8	0,96
1/8"-1/4"	2030 1/8 1/4	1,35
1/8"-3/8"	2030 1/8 3/8	1,67
1/4"-3/8"	2030 1/4 3/8	1,82
1/4"-1/2"	2030 1/4 1/2	2,76
3/8"-1/2"	2030 3/8 1/2	3,05
1/2"-3/4"	2030 1/2 3/4	4,65

# Adaptador

Adaptors  
Adaptateurs  
Adattatori

## Prolongador M BSP cilíndrico/Métrico - H BSP cilíndrica

Extensor M BSP Paralel/M metric - F BSP parallel

Prolongateur cylindrique standard

Prolunga cilindrica standard



THREAD ROSCA	Part nº Referencia	€
M5-1/8"	2050 M5 1/8	1,03
1/8"-1/8"	2050 1/8 1/8	0,93
1/8"-1/4"	2050 1/8 1/4	1,62
1/4"-1/4"	2050 1/4 1/4	1,53
1/4"-3/8"	2050 1/4 3/8	2,24
3/8"-3/8"	2050 3/8 3/8	2,59
3/8"-1/2"	2050 3/8 1/2	4,55
1/2"-1/2"	2050 1/2 1/2	5,32

## Prolongador extra M-H BSP cilíndrico

Extra extensor M-F BSP parallel

Prolongateur cylindrique

Prolunga cilindrica



THREAD ROSCA	Part nº Referencia	€
1/8"-1/8"	2070 1/8 1/8 22	1,29
1/8"-1/8"	2070 1/8 1/8 42	2,50
1/4"-1/4"	2070 1/4 1/4 35	2,45
1/4"-1/4"	2070 1/4 1/4 51	3,61

## Adaptador H BSP cilíndrico

Adaptor F BSP parallel

Manchon femelle

Prolunga femmina



THREAD ROSCA	Part nº Referencia	€
1/8"	3000 1/8	0,81
1/4"	3000 1/4	1,58
3/8"	3000 3/8	2,98
1/2"	3000 1/2	4,12
3/4"	3000 3/4	6,69

## Tapón reductor M BSP cilíndrico/Métrico-H BSP cilíndrico

Reducer parallel

Bouchon réducteur cylindrique

Tappo di riduzione cilindrico



THREAD ROSCA	Part nº Referencia	€
1/8"-M5	2090 1/8 M5	0,87
1/4"-1/8"	2090 1/4 1/8	0,87
3/8"-1/8"	2090 3/8 1/8	1,53
3/8"-1/4"	2090 3/8 1/4	1,02
1/2"-1/4"	2090 1/2 1/4	1,78
1/2"-3/8"	2090 1/2 3/8	1,82
3/4"-1/2"	2090 3/4 1/2	3,49

## Reductor H BSP cilíndrico

Reducer F BSP parallel

Manchon femelle de réduction

Prolunga femmina di riduzione



THREAD ROSCA	Part nº Referencia	€
1/8"-1/4"	3010 1/8 1/4	1,61
1/8"-3/8"	3010 1/8 3/8	1,74
1/4"-3/8"	3010 1/4 3/8	1,88
1/4"-1/2"	3010 1/4 1/2	1,74
3/8"-1/2"	3010 3/8 1/2	2,77
1/2"-3/4"	3010 1/2 3/4	3,95

## Orientable H BSP cilíndrico

Banjo F BSP parallel

Banjo femelle

Occhio filettato femmina



THREAD ROSCA	Part nº Referencia	€
1/8"	6090 1/8	2,51
1/4"	6090 1/4	3,18
3/8"	6090 3/8	4,40

# Adaptador

Adaptors  
Adaptateurs  
Adattatori

## Tornillo orientable simple M BSP cilíndrico/M métrico

Simple banjo bolt M BSP parallel/M metric

Vis pour banjo simple

Bullone banjo semplice



THREAD ROSCA	Part nº Referencia	€
M5	51410 M5	1,45
M6	51410 M6	1,56
M12x1.5	51410 M12	2,51
1/8"	51410 1/8	1,90
1/4"	51410 1/4	2,42
3/8"	51410 3/8	3,48
1/2"	51410 1/2	6,02

## Tornillo orientable doble M BSP cilíndrico

Double banjo bolt M BSP parallel

Vis pour banjo double

Bullone forato doppio



THREAD ROSCA	Part nº Referencia	€
1/8"	51420 1/8	2,62
1/4"	51420 1/4	3,78
3/8"	51420 3/8	5,70
1/2"	51420 1/2	9,68

## Tapón allen interior M BSPT cónico

Internal Allen plug M BSPT tapered

Bouchon mâle conique Allen intérieur

Tappo maschio conico Allen



THREAD ROSCA	Part nº Referencia	€
1/8"	3025 1/8	0,51
1/4"	3025 1/4	0,73
3/8"	3025 3/8	1,11
1/2"	3025 1/2	1,83

## Tapón M BSPT cónico

Plug M BSPT tapered

Bouchon mâle conique

Tappo maschio conico



THREAD ROSCA	Part nº Referencia	€
1/8"	3021 1/8	1,65
1/4"	3021 1/4	1,83
3/8"	3021 3/8	2,27
1/2"	3021 1/2	4,19

## Tapón allen M BSP cilíndrico

Allen plug M BSP parallel

Bouchon mâle cylindrique Allen

Tappo maschio cilindrico Allen



THREAD ROSCA	Part nº Referencia	€
1/8"	3015 1/8	0,80
1/4"	3015 1/4	1,09
3/8"	3015 3/8	1,53
1/2"	3015 1/2	2,74

## Tapón M BSP cilíndrico

Plug M BSP parallel

Bouchon mâle cylindrique

Tappo maschio cilindrico



THREAD ROSCA	Part nº Referencia	€
1/8"	3020 1/8	0,84
1/4"	3020 1/4	1,11
3/8"	3020 3/8	1,48
1/2"	3020 1/2	2,51
3/4"	3020 3/4	4,07

## Tapón H BSP cilíndrico

Plug F BSP parallel

Bouchon femelle

Tappo femmina



THREAD ROSCA	Part nº Referencia	€
1/8"	3030 1/8	0,77
1/4"	3030 1/4	1,33
3/8"	3030 3/8	1,95
1/2"	3030 1/2	3,06

# Adaptador

Adaptors  
Adaptateurs  
Adattatori

## Codo M BSPT cónico

Elbow M BSPT tapered

Raccord coudé mâle-mâle conique

Adattore a 90 maschio conico



THREAD ROSCA	Part nº Referencia	€
1/8"	5000 1/8	1,24
1/4"	5000 1/4	2,03
3/8"	5000 3/8	2,54
1/2"	5000 1/2	4,24
3/4"	5000 3/4	7,41

## Codo H BSP cilíndrico

Elbow F BSP parallel

Raccord coudé femelle-femelle

Adattore a 90 femmina



THREAD ROSCA	Part nº Referencia	€
1/8"	5010 1/8	1,89
1/4"	5010 1/4	2,62
3/8"	5010 3/8	2,54
1/2"	5010 1/2	6,48
3/4"	5010 3/4	10,31

## Codo M BSPT cónico-H BSP cilíndrico

Elbow M BSPT tapered-F BSP

Raccord coudé mâle-femelle conique

Adattore maschio conico-femmina



THREAD ROSCA	Part nº Referencia	€
1/8"	5020 1/8	1,51
1/4"	5020 1/4	2,23
3/8"	5020 3/8	4,02
1/2"	5020 1/2	6,48
3/4"	5020 3/4	8,96

## T M BSPT cónico

Tee M BSPT tapered

Raccord en té mâle

Adattore a T maschio conico



THREAD ROSCA	Part nº Referencia	€
1/8"	4010 1/8	2,60
1/4"	4010 1/4	3,67
3/8"	4010 3/8	5,60
1/2"	4010 1/2	9,16
3/4"	4010 3/4	12,50

## T lateral H BSP-H BSP-M BSPT cónico

Tee lateral F BSP -F BSP -M BSPT tapered

Raccord en té mâle latéral

Adattore a T maschio conico laterale



THREAD ROSCA	Part nº Referencia	€
1/8"	4050 1/8	1,93
1/4"	4050 1/4	4,62
3/8"	4050 3/8	6,93
1/2"	4050 1/2	9,86
3/4"	4050 3/4	13,64

## T central H BSP-M BSPT cónico-H BSP

Tee central F BSP -M BSPT -F BSP tapered

Raccord en té mâle central

Adattore a T maschio conico centrale



THREAD ROSCA	Part nº Referencia	€
1/8"	4040 1/8	2,23
1/4"	4040 1/4	5,09
3/8"	4040 3/8	5,86
1/2"	4040 1/2	11,33
3/4"	4040 3/4	13,48

## T H BSP cilíndrico

Tee F BSP parallel

Raccord en té femelle

Adattore a T femmina



THREAD ROSCA	Part nº Referencia	€
1/8"	4000 1/8	2,16
1/4"	4000 1/4	3,78
3/8"	4000 3/8	5,51
1/2"	4000 1/2	8,98
3/4"	4000 3/4	15,02

# Adaptador

Adaptors  
Adaptateurs  
Adattatori

## Y central H BSP cilíndrico-M BSPT cónico-H BSP cilíndrico

*Y central F BSP -M BSPT -F BSP tapered*

Raccord en Y mâle

*Adattore a Y maschio*



THREAD ROSCA	Part nº Referencia	€
1/8"	6000 1/8	2,31
1/4"	6000 1/4	2,93
3/8"	6000 3/8	4,08
1/2"	6000 1/2	11,11

## Cruz M BSPT cónico

*Cross M BSPT tapered*

Raccord en croix mâle

*Croce maschio*



THREAD ROSCA	Part nº Referencia	€
1/8"	6030 1/8	1,85
1/4"	6030 1/4	3,47
3/8"	6030 3/8	5,55
1/2"	6030 1/2	7,63

## Cruz en taco H BSP cilíndrico

*Cross in block F BSP parallel*

Nourrices de distribution en croix taraudée

*Croce in blocco*



THREAD ROSCA	Part nº Referencia	€
1/8"	6040 1/8	4,79
1/4"	6040 1/4	7,53
3/8"	6040 3/8	11,57
1/2"	6040 1/2	13,97

## Cruz H BSP cilíndrico

*Cross F BSP parallel*

Raccord en croix femelle

*Croce femmina*



THREAD ROSCA	Part nº Referencia	€
1/8"	6020 1/8	4,26
1/4"	6020 1/4	5,78
3/8"	6020 3/8	8,47
1/2"	6020 1/2	14,48

## Regleta lateral en taco H BSP cilíndrico

*Distribution manifold-F BSP parallel*

Nourrices de distribution taraudée

*Blocco a multiuscite*



THREAD ROSCA	EXITS NR. Nº DE SALIDAS	Part nº Referencia	€
(1) 1/8" - (2) 1/4"	2	6047 1/4 1/8 2	13,73
(1) 1/8" - (2) 1/4"	3	6047 1/4 1/8 3	18,83
(1) 1/8" - (2) 1/4"	4	6047 1/4 1/8 4	24,44
(1) 1/8" - (2) 1/4"	5	6047 1/4 1/8 5	31,35
(1) 1/8" - (2) 1/4"	6	6047 1/4 1/8 6	36,78
(1) 1/4" - (2) 3/8"	2	6047 3/8 1/4 2	16,36
(1) 1/4" - (2) 3/8"	3	6047 3/8 1/4 3	20,05
(1) 1/4" - (2) 3/8"	4	6047 3/8 1/4 4	26,53
(1) 1/4" - (2) 3/8"	5	6047 3/8 1/4 5	33,00
(1) 1/4" - (2) 3/8"	6	6047 3/8 1/4 6	39,72
(1) 3/8" - (2) 1/2"	2	6047 1/2 3/8 2	20,37
(1) 3/8" - (2) 1/2"	3	6047 1/2 3/8 3	24,39
(1) 3/8" - (2) 1/2"	4	6047 1/2 3/8 4	30,68
(1) 3/8" - (2) 1/2"	5	6047 1/2 3/8 5	36,01
(1) 3/8" - (2) 1/2"	6	6047 1/2 3/8 6	42,21

**MINIPOWER PACK TEST BENCH  
BANCO DE PRUEBAS MINICENTRAL**



**BANCO PARA MANTENIMIENTO Y REPARACIÓN DE DE PRENSAS HIDRÁULICAS  
MAINTENANCE & REPAIR BENCH FOR HYDRAULIC CRIMPING MACHINES**



# TALLER DE HIDRÁULICA

**MÁQUINA DE LIMPIEZA  
CLEANING MACHINE**



**BANCO DE PRUEBAS CONVENCIONAL  
CONVENTIONAL TEST BENCH**



**COMPRESOR PARA CARGA DE ACUMULADORES  
PLASMA CUTTING AND WELDING MACHINES**



**MAQUINAS DE CORTE POR PLASMA Y SOLDADURA  
ACCUMULATOR CHARGING COMPRESSOR**



# HYDRAULIC COMPONENT WORKSHOP

**DISEÑO Y FABRICACION DE PROYECTOS HIDRÁULICOS  
DESIGN & MANUFACTURE OF HYDRAULIC PROJECTS**



**MONTAJE DE MINICENTRAL  
MINIPOWER PACK ASSEMBLY**



**MONTAJE BOMBAS HIDRÁULICAS  
HYDRAULIC PUMP ASSEMBLY**



## Enchufes rápidos neumáticos

*Quick release couplings*

Coupleurs pneumatiques

*Innesti rapidi*

### Enchufes mini serie mignon

372

*Mini serie mignon*

Coupleurs mini - série mignon

*Innesti mini- serie mignon*

### Enchufes mini - serie uni ISO 6150 B-12

373

*Mini-serie uni ISO 6150 B-12*

Coupleurs mini - série uni ISO 6150 B-12

*Innesti Mini-serie uni ISO 6150 B-12*

### Enchufes mini - serie multipresa

374

*Mini-serie multipress*

Coupleurs mini - série multiprise

*Innesti Mini-serie uni Multipresa*

### Enchufes rápidos Esto

375

*Quick release couplings "Esto"*

Coupleurs rapides type Esto

*Innesti rapidi tipo ESTO*



3

## Enchufes mini serie mignon

*Mini serie mignon*

Coupleurs mini - série mignon

Innesti mini- serie mignon

### ■ Roscados / Screwed / Fileté / Filetati

| 372



111



211



112



212

### ■ Con espiga / With hose tail / Avec embout / Con adattatori

| 372



115



215

### ■ Push-on / Push-on / Push-on / Push-on

| 372



114



214



113



213

## Enchufes mini - serie uni ISO 6150 B-12

*Mini-serie uni ISO 6150 B-12*

Coupleurs mini - série uni ISO 6150 B-12

Innesti Mini-serie uni ISO 6150 B-12

### ■ Roscados / Screwed / Fileté / Filetati

| 373



121



221



122



222

### ■ Con espiga / With hose tail / Avec embout / Con adattatori

| 373



125



225

### ■ Push-on / Push-on / Push-on / Push-on

| 373



223

## Enchufes mini - serie multipresa

Mini-serie multipress  
Coupleurs mini - série multiprise  
Innesti Mini-serie uni Multipresa

### ■ Roscado / Screwed / Fileté / Filetati

| 374



191



192

### ■ Con espiga / With hose tail / Avec embout / Con adattatori

| 374



195

### ■ Push-on / Push-on / Push-on / Push-on

| 374



194



193

## Enchufes rápidos Esto

Quick release couplings "Esto"  
Coupleurs rapides type Esto  
Innesti rapidi tipo ESTO

### ■ Enchufes 1/4 / Quick couplings 1/4 / Coupleurs 1/4 / Innesto 1/4

| 375



ESTO 1



ESTO 1



ESTO 1

### ■ Enchufes 3/8 / Quick couplings 3/8 / Coupleurs 3/8 / Innesto 3/8

| 375



ESTO 3



ESTO 3

### ■ Enchufes 1/2 / Quick couplings 1/2 / Coupleurs 1/2 / Innesto 1/2

| 375



ESTO 2



ESTO 2

# Enchufes mini serie mignon

Mini serie mignon

Coupleurs mini - série mignon

Innesti mini- serie mignon

## Enchufe Mignon hembra-M BSP cilíndrico

Coupling Mignon female - M BSP parallel

Coupleur femelle à mâle- série mignon

Innesto femmina a fileto mascho-serie mignon



THREAD ROSCA	Part nº Referencia	€
1/8"	111 1/8	3,98
1/4"	111 1/4	7,28
3/8"	111 3/8	3,52

## Enchufe Mignon macho-M BSP cilíndrico

Coupling Mignon male - M BSP parallel

Coupleur mâle à mâle- série mignon

Innesto mascho a fileto mascho-serie mignon



THREAD ROSCA	Part nº Referencia	€
1/8"	211 1/8	1,49
1/4"	211 1/4	1,88
3/8"	211 3/8	1,93

## Enchufe Mignon hembra-espiga

Coupling Mignon female-hose tail

Coupleur femelle à douille- série mignon

Innesto femmina ad inserto-serie mignon



Ø NIPPLE Ø ESPIGA	Part nº Referencia	€
4 mm	115 4	9,18
6 mm	115 6	9,18
8 mm	115 8	9,18

## Enchufe Mignon hembra-push-on

Coupling Mignon female-push-on

Coupleur femelle à tube- série mignon

Innesto femmina a tubo-serie mignon



PIPE TUBO	Part nº Referencia	€
6/4 mm	114 6/4	9,73
8/6 mm	114 8/6	9,73

## Enchufe Mignon macho-push-on

Coupling Mignon male - push-on

Coupleur mâle à tube- série mignon

Innesto mascho a tubo-serie mignon



PIPE TUBO	Part nº Referencia	€
6/4 mm	214 6/4	2,54
8/6 mm	214 8/6	2,66

## Enchufe Mignon hembra-H BSP cilíndrico

Female socket-serie mignon

Coupleur femelle à femelle- série mignon

Innesto femmina a fileto femmina-serie mignon



THREAD ROSCA	Part nº Referencia	€
1/8"	112 1/8	4,07
1/4"	112 1/4	4,07
3/8"	112 3/8	4,07

## Enchufe Mignon macho-H BSP cilíndrico

Coupling Mignon male-F BSP parallel

Coupleur mâle à femelle- série mignon

Innesto mascho a fileto femmina-serie mignon



THREAD ROSCA	Part nº Referencia	€
1/8"	212 1/8	1,36
1/4"	212 1/4	1,84
3/8"	212 3/8	1,88

## Enchufe Mignon macho-espiga

Coupling Mignon male-hose tail

Coupleur mâle à douille- série mignon

Innesto mascho ad inserto-serie mignon



Ø NIPPLE Ø ESPIGA	Part nº Referencia	€
6 mm	215 6	1,61
4 mm	215 4	1,61
8 mm	215 8	1,92

## Enchufe Mignon hembra-push-on c/muelle

Coupling Mignon female - push-on w/nut+spring

Coupleur femelle à tube ressort- série mignon

Innesto femmina a tubo molla-serie mignon



PIPE TUBO	Part nº Referencia	€
6/4 mm	113 6/4	11,36
8/6 mm	113 8/6	11,36

## Enchufe Mignon macho-push-on c/muelle

Coupling Mignon male - push-on w/nut+spring

Coupleur mâle à tube ressort- série mignon

Innesto mascho a tubo molla-serie mignon



PIPE TUBO	Part nº Referencia	€
6/4 mm	213 6/4	3,93
8/6 mm	213 8/6	4,10

# Enchufes mini - serie uni ISO 6150 B-12

Mini-serie uni ISO 6150 B-12

Coupleurs mini - série uni ISO 6150 B-12

Innesti Mini-serie uni ISO 6150 B-12

## Enchufe UNI 615 B-12 hembra-M BSP

Coupling UNI 615 B-12 female-M BSP

Coupleur femelle à mâle- série uni ISO 6150 B-12

Innesto femmina a filetto maschio-serie uni ISO 6150 B-12



THREAD ROSCA	Part n° Referencia	€
1/4"	121 1/4	4,78
3/8"	121 3/8	7,41
1/2"	121 1/2	10,46

## Enchufe UNI 615 B-12 hembra-H BSP

Coupling UNI 615 B-12 female-F BSP

Coupleur femelle à femelle- série uni ISO 6150 B-12

Innesto femmina a filetto femmina-serie uni ISO 6150 B-12



THREAD ROSCA	Part n° Referencia	€
1/4"	122 1/4	4,78
3/8"	122 3/8	7,41
1/2"	122 1/2	10,39

## Enchufe UNI 615 B-12 macho-M BSP

Coupling UNI 615 B-12 male-M BSP

Coupleur mâle à mâle- série uni ISO 6150 B-12

Innesto maschio a filetto maschio-serie uni ISO 6150 B-12



THREAD ROSCA	Part n° Referencia	€
1/4"	221 1/4	0,84
3/8"	221 3/8	1,79
1/2"	221 1/2	2,51

## Enchufe UNI 615 B-12 macho-H BSP

Coupling UNI 615 B-12 male-F BSP

Coupleur mâle à femelle- série uni ISO 6150 B-12

Innesto maschio a filetto femmina-serie uni ISO 6150 B-12



THREAD ROSCA	Part n° Referencia	€
1/4"	222 1/4	0,84
3/8"	222 3/8	1,91
1/2"	222 1/2	2,59

## Enchufe UNI 615 B-12 hembra-espiga

Socket with rest for rubber hose-serie uni ISO 6150 B-12

Coupleur femelle à douille- série uni ISO 6150 B-12

Innesto femmina ad inserto-serie uni ISO 6150 B-12



Ø NIPPLE Ø ESPIGA	Part n° Referencia	€
6 mm	125 6	8,56
8 mm	125 8	8,88
10 mm	125 10	8,88
12 mm	125 12	8,88

## Enchufe UNI 615 B-12 macho-espiga

Coupling UNI 615 B-12 male-hose tail

Coupleur mâle à douille- série uni ISO 6150 B-12

Innesto maschio ad inserto-serie uni ISO 6150 B-12



Ø NIPPLE Ø ESPIGA	Part n° Referencia	€
6 mm	225 6	1,11
8 mm	225 8	1,28
10 mm	225 10	1,35
12 mm	225 12	1,95

## Enchufe UNI 615 B-12 macho-push-on c/muelle

Coupling UNI 615 B-12 male-push-on w/ nut+spring

Coupleur mâle à tube ressort- série uni ISO 6150 B-12

Innesto maschio a tubo molla-serie uni ISO 6150 B-12



PIPE TUBO	Part n° Referencia	€
6/4 mm	223 6/4	4,39
8/6 mm	223 8/6	4,64
10/8 mm	223 10/8	5,13
12/10 mm	223 12/10	5,73

## Enchufes mini - serie multipresa

Mini-serie multipress

Coupleurs mini - série multiprise

Innesti Mini-serie uni Multipresa

### Enchufe multipresa hembra-M BSP

Coupling multisocket female-F BSP

Coupleur femelle à mâle- série multiprise

Innesto femmina a filetto maschio-serie multipress



THREAD ROSCA	Part n° Referencia	€
1/4"	191 1/4	11,92
3/8"	191 3/8	11,92
1/2"	191 1/2	12,84

### Enchufe multipresa hembra-H BSP

Coupling multisocket female-F BSP

Coupleur femelle à femelle- série multiprise

Innesto femmina a filetto femmina-serie multipress



THREAD ROSCA	Part n° Referencia	€
1/4"	192 1/4	12,73
3/8"	192 3/8	12,73
1/2"	192 1/2	13,68

### Enchufe multipresa hembra-espiga

Coupling multisocket female-hose tail

Coupleur femelle à douille- série multiprise

Innesto femmina ad inserto-serie multipress



Ø NIPPLE Ø ESPIGA	Part n° Referencia	€
6 mm	195 6	12,73
8 mm	195 8	12,73
10 mm	195 10	12,73
12 mm	195 12	12,73

### Enchufe multipresa hembra-push-on

Coupling multisocket female-push-on

Coupleur femelle à tube- série multiprise

Innesto femmina a tubo-serie multipress



PIPE TUBO	Part n° Referencia	€
6/4 mm	194 6/4	12,93
8/6 mm	194 8/6	13,25
10/8 mm	194 10/8	13,25

### Enchufe multipresa hembra-push-on c/muelle

Coupling multisocket female-push-on w/  
nut+spring

Coupleur femelle avec ressort- série multiprise

Innesto femmina con molla-serie multipress



PIPE TUBO	Part n° Referencia	€
6/4 mm	193 6/4	14,59
8/6 mm	193 8/6	15,06
10/8 mm	193 10/8	15,06

Normativa | Standard | Standard

## 41 ENCHUFE PARA NORMATIVAS



1 socket for 4 standards  
1 corps pour 4 embouts

Ø 5,5 mm



SUECA / SWEDISH / SUEDOISE

Ø 7,5 mm



EUROPEA / EUROPEAN / EUROPEENNE

Ø 5 mm



ITALIANA / ITALIAN / ITALIENNE

Ø 5,5 mm



UNI ISO 6150 B-12

# Enchufes rápidos Esto

Quick release couplings "Esto"  
Coupleurs rapides type Esto  
Innesti rapidi tipo ESTO

## Enchufe Esto hembra 1/4

Coupling Esto female 1/4

Coupleur femelle 1/4

Innesto hembra 1/4



THREAD ROSCA	Ø NIPPLE Ø ESPIGA	Part n° Referencia	€
M 1/4" BSPT	-	ESTO 110	22,20
M 3/8" BSPT	-	ESTO 140	22,61
M 1/2" BSPT	-	ESTO 142	22,61
F 1/4" BSP	-	ESTO 120	22,20
F 3/8" BSP	-	ESTO 150	22,61
-	8 mm	ESTO 130	22,80
-	10 mm	ESTO 131	22,80

## Enchufe Esto ECO hembra 1/4

Coupling Esto ECO female 1/4

Coupleurs 1/4 ECO

Innesto 1/4 ECO



THREAD ROSCA	Ø NIPPLE Ø ESPIGA	Part n° Referencia	€
M 1/4" BSPT	-	ESTO 1110	20,24
M 3/8" BSPT	-	ESTO 1140	20,61
M 1/2" BSPT	-	ESTO 1142	20,61
F 1/4" BSP	-	ESTO 1120	20,24
F 3/8" BSP	-	ESTO 1150	20,98
F 1/2" BSP	-	ESTO 1152	21,24
-	8 mm	ESTO 1130	20,83
-	10 mm	ESTO 1131	20,83
-	12/13 mm	ESTO 1132	20,83
-	6 mm	ESTO 1136	20,83

## Enchufe Esto hembra 3/8

Coupling Esto female 3/8

Coupleur femelle 3/8

Innesto femmina 3/8



THREAD ROSCA	Ø NIPPLE Ø ESPIGA	Part n° Referencia	€
M 3/8" BSPT	-	ESTO 310	36,50
M 1/2" BSP	-	ESTO 312	38,98
F 3/8" BSP	-	ESTO 320	36,50
-	12 mm	ESTO 330	40,47

## Enchufe Esto hembra 1/2

Coupling Esto female 1/2

Coupleur femelle 1/2

Innesto femmina 1/2



THREAD ROSCA	Ø NIPPLE Ø ESPIGA	Part n° Referencia	€
M 1/2" BSPT	-	ESTO 210	53,09
F 1/2" BSP	-	ESTO 220	53,09

## Enchufe Esto macho 1/4

Coupling Esto male 1/4

Coupleur embout mâle 1/4

Innesto maschio 1/4



THREAD ROSCA	Ø NIPPLE Ø ESPIGA	Part n° Referencia	€
M 1/4" BSPT	-	ESTO 160	5,05
M 3/8" BSPT	-	ESTO 163	6,27
M 1/2" BSPT	-	ESTO 162	11,03
F 1/4" BSP	-	ESTO 170	5,05
F 3/8" BSP	-	ESTO 173	6,27
-	6 mm	ESTO 181	5,05
-	8 mm	ESTO 180	5,05
-	10 mm	ESTO 182	5,05

## Enchufe Esto macho 3/8

Coupling Esto male 3/8

Coupleur embout mâle 3/8

Innesto maschio 3/8



THREAD ROSCA	Ø NIPPLE Ø ESPIGA	Part n° Referencia	€
M 3/8" BSPT	-	ESTO 360	8,24
F 3/8" BSP	-	ESTO 370	8,24
-	12 mm	ESTO 380	8,99

## Enchufe Esto macho 1/2

Coupling Esto male 1/2

Coupleur embout mâle 1/2

Innesto maschio 1/2



THREAD ROSCA	Ø NIPPLE Ø ESPIGA	Part n° Referencia	€
M 1/2" BSPT	-	ESTO 260	10,95
F 1/2" BSP	-	ESTO 270	11,84

# COMPONENTES HIDRÁULICOS Y NEUMÁTICOS

## HYDRAULIC AND PNEUMATIC COMPONENTS

Depositos, Filtros, Campanas y Acoplamientos

Tanks, Filters, Bellhousings & Couplings



TrAde®

Bombas, Divisores de Caudal y Multiplicadores

Pumps, Flow Dividers & Multigears



TrAde®

Minicentrales

Mini power packs



TrAde®

Válvulas Hidráulicas

Hydraulic Valves



TrAde®

Distribuidores Hidráulicos

Hydraulic Control Valves



TrAde®

Electroválvulas y Placas Base

Directional Valves & Subplates



TrAde®

Empuñaduras y Selectores

Joysticks & Directional Valves



TrAde®

Acumuladores, Presostatos e Intercambiadores de Calor

Accumulators, Pressure Switches & Heat Exchangers



TrAde®

Motores Lentos Hidráulicos

Hydraulic Motors



TrAde®

Cilindros Hidráulicos

Hydraulic Cylinders



TrAde®

Neumática: Accesorios, Válvulas, Cilindros y Microcilindros

Pneumatics: Accessories, Valves, Cylinders and Micro-cylinders



TrAde®







# SALINAS

CAUCHOS Y POLIURETANOS

ISO 9001

BUREAU VERITAS  
Certification



BARRIO BARRONDO, 12, POLÍGONO LANDETXE. 48480 ZARATAMO. BIZKAIA. ESPAÑA  
TFNO.: (34) 946 712 505 - FAX: (34) 946 712 638 - EMAIL: salinas@productos-salinas.com  
WEB: <http://www.productos-salinas.com>