



SALINAS

CAUCHOS Y POLURETANOS



Racores Inoxidable

2016

Stainless Steel Fittings
Raccords en Acier Inox
Raccordi en Acciao Inossidabile

MEJORAMOS NUESTRA PLATAFORMA DIGITAL

WE'RE UPDATING OUR WEBSITE TO SERVE YOU BETTER.

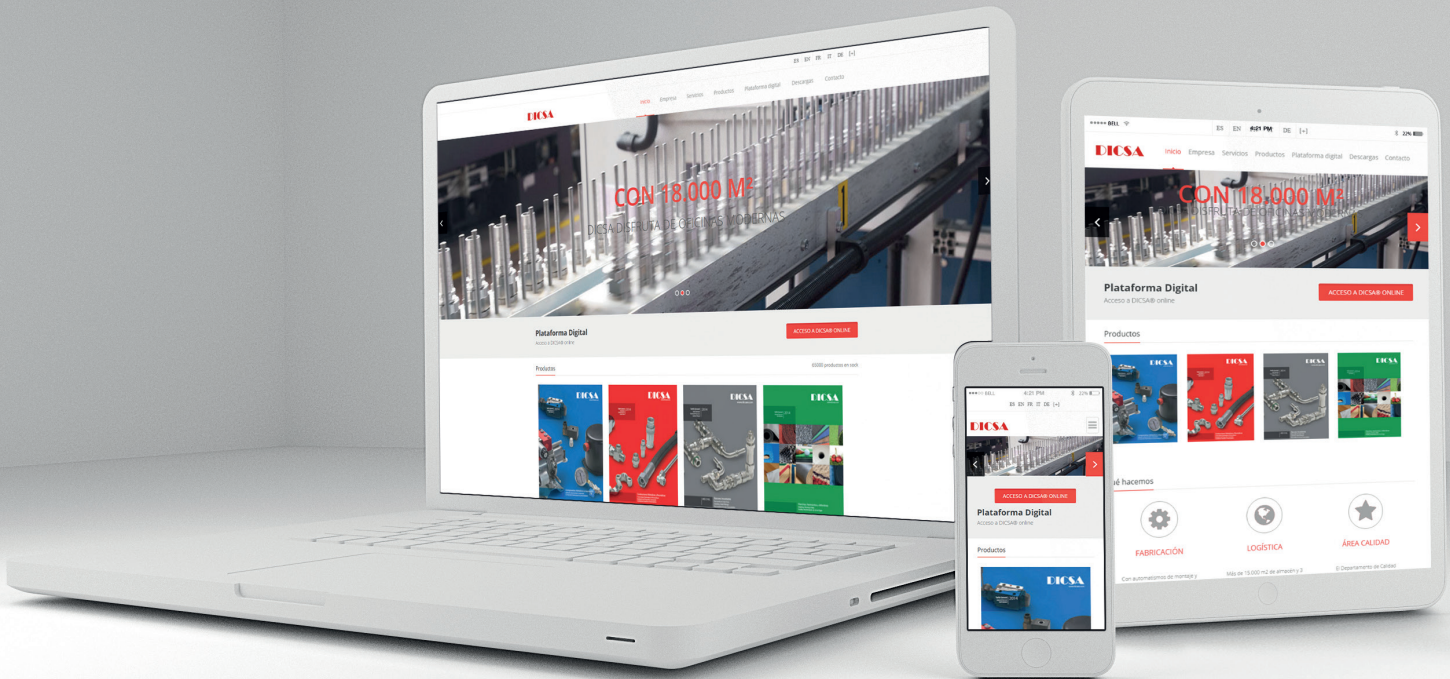

Gestione usted mismo sus restos de pedido pendientes de servir.



Disponibilidad del producto según cantidad solicitada



Puede consultar sus pedidos en curso y ver su estado en tiempo real.



Gestione su pedido online y además puede ver y crear ofertas desde su área cliente.



Pedidos W-Express: En este tipo de pedidos garantizamos la salida del pedido en el día.



Seleccione su medio de transporte en función de precios, plazos,...



También podrá incorporar diferentes usuarios para gestionar el sistema y decidir el nivel de acceso al sistema de los mismos.



Handle by yourself your backorders pending to be served.



Product availability according to quantity ordered.



Check order status: You can consult their orders online and in real time.



Clients can manage their orders online and see and create quotes in the Client Area.



W-Express Orders: With this type of order we guarantee same-day shipping.



Select means of transport according to price, delivery times, etc.



Create auxiliary users: Clients can also add different users to manage the system and can decide their level of access to the system.

Conexiones para flexibles
Crimp fittings for hoses
Embouts à sertir pour flexibles
Raccordi a pressione per tubi flessibili

1

Racores para tubo rígido DIN 2353
Pipe fittings DIN 2353
Raccord tube rigide DIN 2353
Raccordi ad anello DIN 2353

2

Racores JIC 37° / Bidas SAE
Flare fittings JIC 37° / SAE Flanges
Raccords JIC 37° / Brides SAE
Raccordi JIC 37° / Flange SAE

3

Adaptadores
Adaptors
Adapteurs
Adattatori

4

Racores soldables
Welding fittings
Raccords à souder
Raccordi a saldare

5

Racores industriales
Industrial fittings
Raccords industriels
Raccordi industriali

6

Enchufes, Llaves y Componentes Hidráulicos
Couplings, Ball valves and Hydraulic Components
Coupleurs, Robinets et Composants Hydrauliques
Innesti rapidi, Rubinetti a sfera e Componenti Idraulici

7

Conexiones para flexibles

Crimp fittings for hoses

Embouts à sertir pour flexibles

Raccordi a pressione per tubi flessibili

Conexiones Standard	21
<i>Standard series</i> Embouts série standard <i>Serie Standard</i>	
Conexiones Serie BW R12/4SP/4SH No Pelar	38
<i>Fittings BW Series R12/4SP/4SH No Skiving</i> Embouts R12/4SP/4SH Série BW Sans dénuder <i>Raccordi R12/4SP/4SH Serie BW senza pelatura</i>	
Conexiones Interlock	42
<i>Interlock series</i> Embouts Interlock <i>Serie Interlock</i>	
Conexiones Compactas Serie 43 R1AT/R2AT/1SN/2SN/R16/2SC	46
<i>One piece fittings 43 Series R1AT/R2AT/1SN/2SN/R16/2SC</i> Embouts pré-sertis R1AT/R2AT/1SN/2SN/R16/2SC Série 43 <i>Raccordi compatti R1AT/R2AT/1SN/2SN/R16/2SC Serie 43</i>	
Conexiones Compactas R7/R8 y Elastómero malla metálica	52
<i>One piece fittings R7/R8 & Elastomer Braid of steel wire</i> Embouts pré-sertis R7/R8 et Elastomère tresse métallique <i>Raccordi compatti serie R7/R8 e elastomero treccia metallica</i>	
Conexiones Compactas PTFE Liso	57
<i>One piece fittings for Smooth PTFE</i> Embouts pré-sertis pour PTFE lisse <i>Raccordi compatti per PTFE liscio</i>	
Conexiones Compactas PTFE Corrugado	62
<i>One piece fittings for convoluted PTFE</i> Embouts pré-sertis pour PTFE convoluto <i>Raccordi compatti per PTFE convoluto</i>	



Conexiones Compactas Serie BW R12/4SP/4SH

One piece fittings BW Series R12/4SP/4SH
Embouts pré-sertis R12/4SP/4SH Série BW
Raccordi Compatti R12/4SP/4SH Serie BW

67

Casquillos para Conexiones Compactas

Ferrules for one piece fittings
Jupes pour embouts pré-sertis
Boccole per raccordi compatti

71

Conexiones Reusables

Reusable series
Embouts série récupérable
Serie Recuperabile

72

Conexiones Push-On

Push-On Fittings
Embouts Push-On
Raccordi Serie Push-On

74

Conexiones Alta Presión (700 bar)

High pressure 700 bar fittings
Embouts haute pression 700 bar
Raccordi Altissima pressione (700 bar)

75

Conexiones Micro-hose

Micro-hose fittings
Embouts Minimes
Raccordi Micro-tubo

77

Serie Standard

Serie Standard
Standard serie
Standard serie

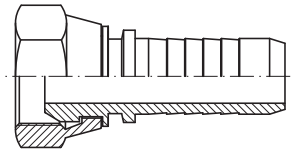

- Una única conexión para una amplia gama de mangueras
One only fitting for a big hose range
Un seul raccord pour une grande gamme de tuyaux
Un solo raccordo per una vasta gamma di tubi

Pipe fittings DIN 2353

Flare fittings JIC37° / SAE Flanges

Adaptors

Welding fittings

Industrial fittings

Couplings, Ball valves and Hydraulic Components

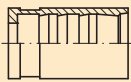
SAE 100
R6EN 854
2TEEN 854
3TEEN 857 1SC
SUPERSERVICE 1SC
155°EN 853 1SN
SAE 100
R1ATEN 853 2SN
SAE 100
R2ATEN 857 2SC
SUPERSERVICE 2SC
155°

81014...

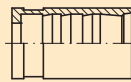

81014...

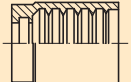

ZPF22120...

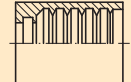
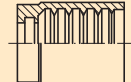

ZSC2112...

ZPF22120...
ZSC2112

ZPF22120...

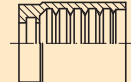

ZPF22120...

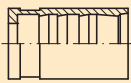
SAE 100
R7
EN 855

81014...

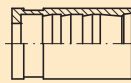
R7
No conductiva

81014...

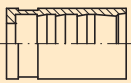
SAE 100
R8
EN 855

81014...

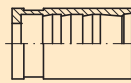
R8
No conductiva

81014...

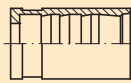
Metallic
braid
elastomer

81014...

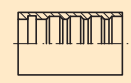
Smooth
PTFE
1 braid

81040...

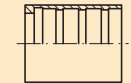
Convoluted
PTFE

81041...

EN 853
2ST
SAE100
R2A

ZPF12240...

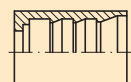
EN 856
4SP
SAE 100 R9R

ZPF12240...

SAE 100
EN 856
R12

ZPF12240...

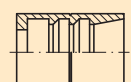
Ecology
200

Z2120...

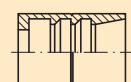
Ecology
210

Z2120...

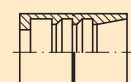
Ecology
250

Z2120...

Serie Interlock

Interlock serie
Série Interlock
Serie Interlock

■ Una única conexión para toda la gama de mangueras de alta presión

One only fitting for all very high pressure hoses
Un seul raccord pour tous les tubes de très haute pression
Un solo raccordo per tutti i tubi ad altissima pressione

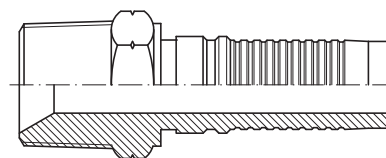

EN 856
4SH

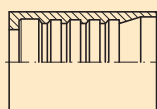

ZA61010...



EN 856
R13
SAE 100

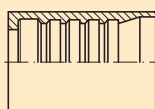

ZA61010...
Z61010...



SAE 100
R15

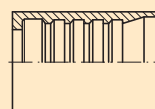

ZA61010...
Z61010...

Serie BW no pelar

BW Series no skiving
Série BW sans dénuder
Serie BW non pelati

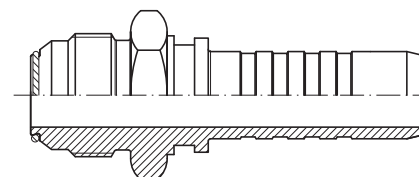

EN 856
4SP
SAE 100

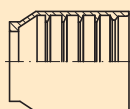

ZAC68010



EN 856
4SH

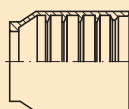

ZAC68010



EN 856
R12
SAE 100

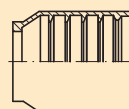

ZAC68010

Crimp fittings for hoses

Pipe fittings DIN 2353

Flare fittings JIC 37° / SAE Flanges

Adaptors

Welding fittings

Industrial fittings

Couplings, Ball valves and Hydraulic Components

Serie Compacta

One Piece Series
Série Pré-sertis
Serie Compatti

Conexiones compactas 1SC / 1SN / 2SC / R6

One piece fittings 1SC / 1SN / 2SC / R6
Embouts pré-sertis 1SC / 1SN / 2SC / R6
Raccordi compatti 1SC / 1SN / 2SC / R6

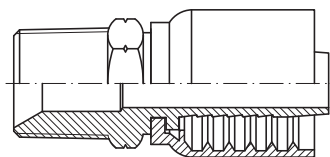

1SC

1SN

2SC

R6

Conexiones compactas Serie 43 R1AT / R2AT / 1SN / 2SN / R16 / R17 / 2SC

One piece fittings 43 Series R1AT / R2AT / 1SN / 2SN / R16 / R17 / 2SC
Embouts pré-sertis R1AT / R2AT / 1SN / 2SN / R16 / R17 / 2SC Série 43
Raccordi compatti R1AT / R2AT / 1SN / 2SN / R16 / R17 / 2SC Serie 43

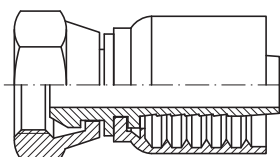

EN 853
1SN
SAE 100
R1AT

EN 853
2 SN
SAE 100
R2AT

EN 857
2SC
SAE 100
R16

R17

SUPERSERVICE
155°
2SC

Conexiones compactas R7 / R8 y elastómero malla metálica

Piece fittings R7 / R8 & braid of steel wire
Embouts pré-sertis R7 / R8 et tresse métallique
Raccordi compatti serie R7 / R8 e elastomero treccia metallica

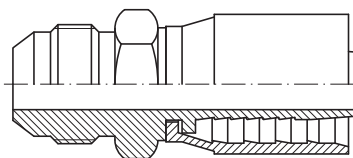

SAE 100
R7

SAE 100
R8

Metallic
braid
elastomer

Conexiones compactas PTFE liso

One piece fittings for smooth PTFE
Embouts pré-sertis pour PTFE lisse
Raccordi compatti serie PTFE liscio

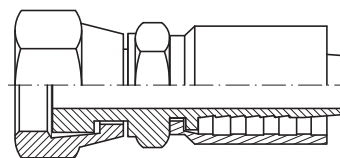

Smooth
PTFE
1 braid

Conexiones compactas PTFE corrugado

One piece fittings for convoluted PTFE
Embouts pré-sertis pour PTFE convolute
Raccordi compatti serie PTFE involuto

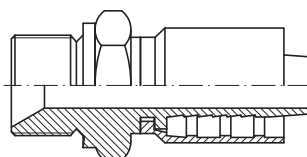

Convoluted
PTFE

Conexiones compactas Serie BW R12 / 4SP / 4SH

One piece fittings BW Series R12 / 4SP / 4SH
Embouts pré-sertis R12 / 4SP / 4SH Série BW
Raccordi compatti R12 / 4SP / 4SH Serie BW

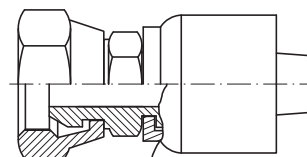

EN 856
R12

EN 856
4SP

4 SH

Conexiones Standard

Standard series
Embouts série standard
Serie Standard

■ Casquillos para prensar / Crimp ferrules / Jupes à sertir / Boccole a pressare

21

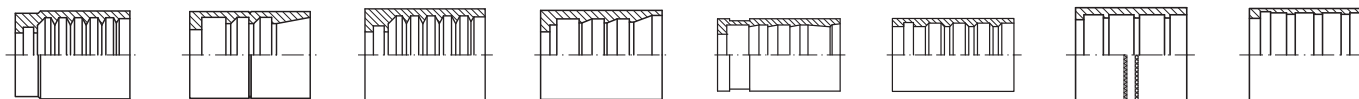

ZPF2212

82003

ZSC2112

ZPF1224

81014

81040

Z21200

81041

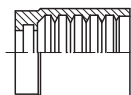

ZPF221201

■ Conexiones BSP / BSP Fittings / Embouts BSP / Raccordi BSP

23

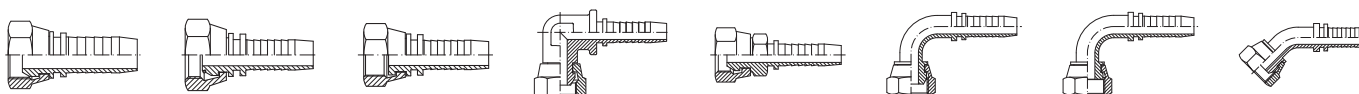

84100

84110

84200

84127

84400

84107

84207

84108

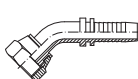

84208

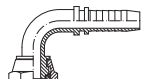

84117

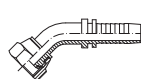

84118



84212



84112

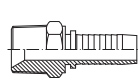

84114

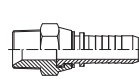

84165



84712



JTVBSP

■ Conexiones NPT-NPSM / NPT-NPSM Fittings / Embouts NPT-NPSM / Raccordi NPT-NPSM

27

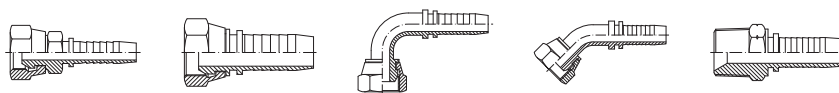

84361

84261

84262

84263

84161

■ Conexiones JIC 37° / JIC 37° Fittings / Embouts JIC 37° / Raccordi JIC 37°

28

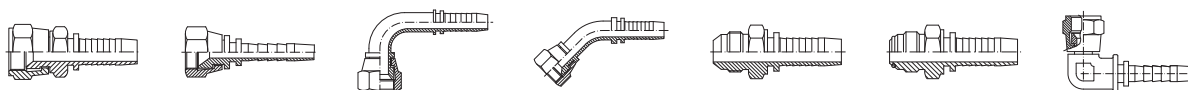

84242

84142

84138

84139

84140

84141

84137

■ Conexiones Métricas DIN 2353 / Metric fittings / Embouts Métriques / Raccordi Metrici

30



84804

84203

84305

84306

Crimp fittings for hoses

Pipe fittings DIN 2353

Flare fittings JIC 37° / SAE Flanges

Adaptors

Welding fittings

Industrial fittings

Couplings, Ball valves and Hydraulic Components

Conexiones Standard

Standard series
Embouts série standard
Serie Standard

■ Espigas lisas / Standpipes / Embouts lisses / Estremità tubolari

32

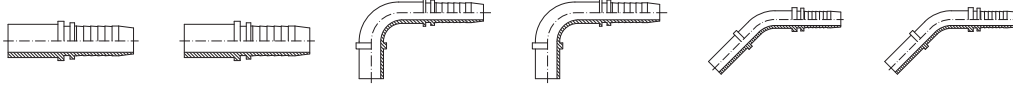

84158

84159

84258

84259

84358

84359

■ Conexiones Varias / Several Fittings / Plusieurs Embouts / Diversi Raccordi

33

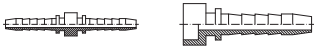

84300

84000

■ Orientables / Banjos / Embouts Banjo / Raccordi ad occhio

34

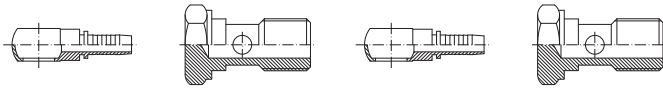

84111

Z1090

84116

Z1092

■ Bridas SAE / SAE Flanges / Brides SAE / Flange SAE

35

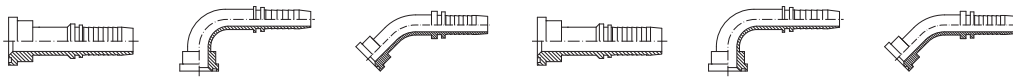

84182

84183

84184

84282

84283

84284

■ Bridas para flexibles / SAE Flanges for hoses / Brides SAE pour flexibles / Flange per tubi flessibili

36

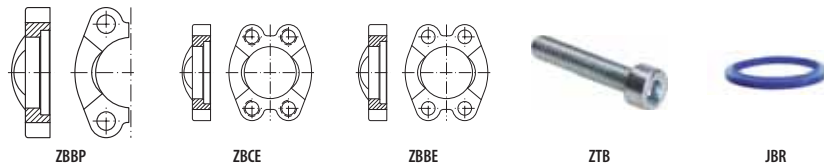

ZBBP

ZBCE

ZBBE

ZTB

JBR

■ Conexiones ORFS / ORFS Fittings / Embouts ORFS / ORFS

37

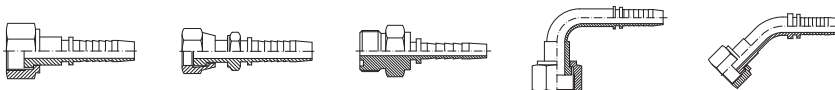

84900

84901

84912

84907

84908

Conexiones Serie BW R12/4SP/4SH No Pelar

Fittings BW Series R12/4SP/4SH No Skiving
 Embouts R12/4SP/4SH Série BW Sans dénuder
 Raccordi R12/4SP/4SH Serie BW senza pelatura

■ Conexiones BSP / BSP fittings / Embouts BSP / Raccordi BSP

38

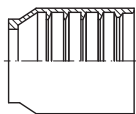

ZAC68010



Z66410



Z66110

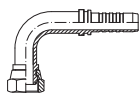

Z66117



Z66118



Z66112

■ Conexiones JIC 37° / JIC 37° fittings / Embouts JIC / Raccordi JIC 37°

39



Z66242

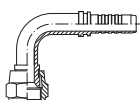

Z66138

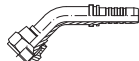

Z66139



Z66141

■ Conexiones NPT/NPSM / NPT/NPSM fittings / Embouts NPT/NPSM / Raccordi NPT/NPSM

39



Z66461



Z66161

■ Conexiones ORFS / ORFS fittings / Embouts ORFS / Raccordi ORFS

40



Z66901

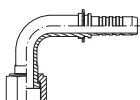

Z66907



Z66908



Z66912

■ Conexiones Métricas DIN 2353 / Metric fittings / Embouts Métriques / Raccordi Metrici

40

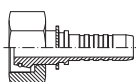

Z66204

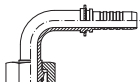

Z66205

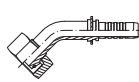

Z66206

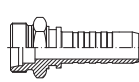

Z66203

■ Bidas SAE / SAE Flanges / Brides SAE / Flange SAE

41



Z66182

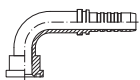

Z66183

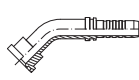

Z66184

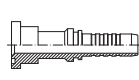

Z66282

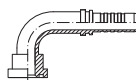

Z66283

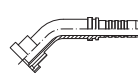

Z66284

Conexiones Interlock

Interlock series
Embouts Interlock
Serie Interlock

■ Casquillos Interlock / Interlock Crimp ferrules / Jupes à sertir Interlock / Boccole a pressare

42

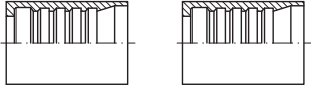

ZA61010

Z61010

■ Conexiones BSP / Interlock BSP fittings / Embouts à sertir Interlock BSP / Raccordi BSP

42

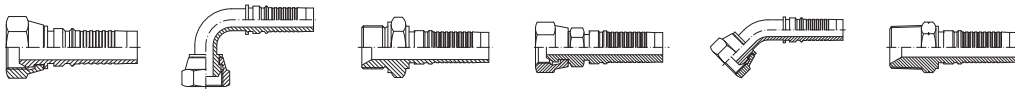

Z64100

Z64107

Z64112

Z64400

Z64108

Z64161

■ Conexiones JIC 37° / Interlock JIC 37° fittings / Embouts à sertir Interlock JIC / Raccordi JIC 37°

43

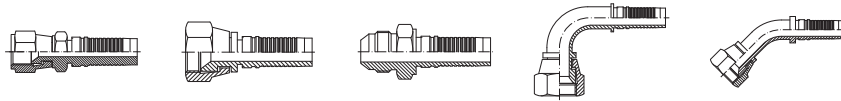

Z64242

Z64142

Z64140

Z64138

Z64139

■ Conexiones Métricas DIN 2353 / Interlock Metric fittings / Embouts Métrique Interlock / Raccordi Metrici

44

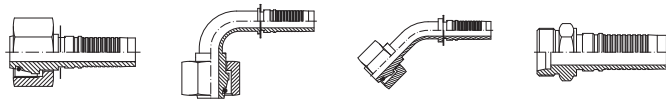

Z64204

Z64205

Z64206

Z64203

■ Conexiones ORFS / Interlock ORFS fittings / Embouts à sertir Interlock ORFS / Raccordi ORFS

44

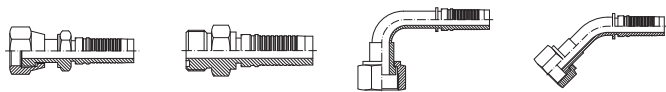

Z64901

Z64912

Z64907

Z64908

■ Bidas SAE / Interlock SAE Flanges / Brides SAE Interlock / Flange SAE

45

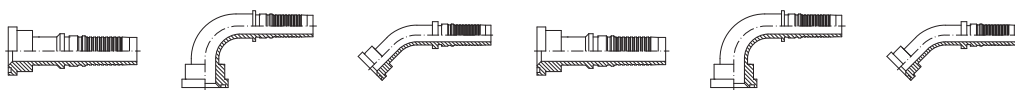

Z64182

Z64183

Z64184

Z64282

Z64283

Z64284

Conexiones Compactas Serie 43 R1AT/R2AT/1SN/2SN/R16/2SC

One piece fittings 43 Series R1AT/R2AT/1SN/2SN/R16/2SC

Embouts pré-sertis R1AT/R2AT/1SN/2SN/R16/2SC Série 43

Raccordi compatti R1AT/R2AT/1SN/2SN/R16/2SC Serie 43

■ Conexiones compactas JIC 37° / One piece JIC 37° fittings / Embouts pré-sertis JIC 37° / Raccordi compatti JIC 37° | 46

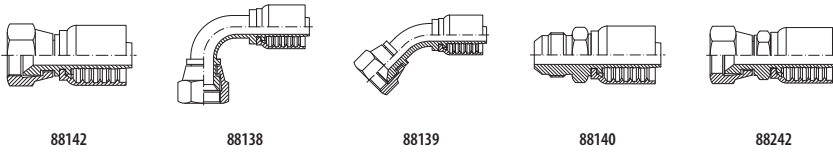

88142

88138

88139

88140

88242

■ Conexiones compactas ORFS / One piece ORFS fittings / Embouts pré-sertis ORFS / Raccordi compatti ORFS | 47

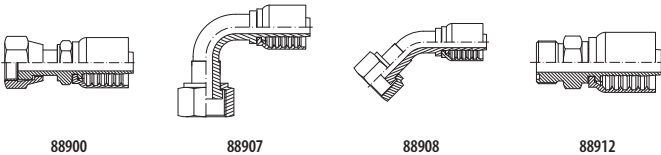

88900

88907

88908

88912

■ Conexiones compactas NPT-NPSM / One piece NPT-NPSM fittings / Embouts pré-sertis NPT-NPSM / Raccordi compatti NPT-NPSM | 48

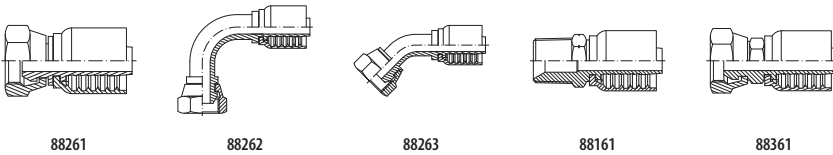

88261

88262

88263

88161

88361

■ Conexiones compactas Bridas SAE / One piece SAE Flanges fittings / Embouts pré-sertis Brides SAE / Raccordi compatti Flange SAE | 49

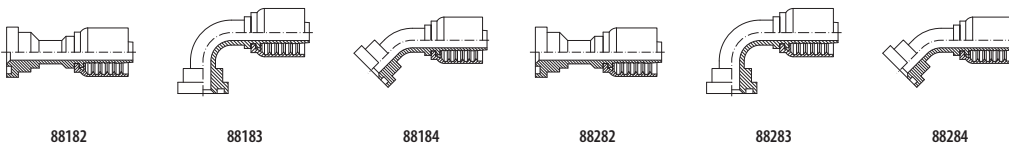

88182

88183

88184

88282

88283

88284

■ Conexiones compactas Métricas / One piece Metric fittings / Embouts pré-sertis Métriques / Raccordi compatti Metrici | 50

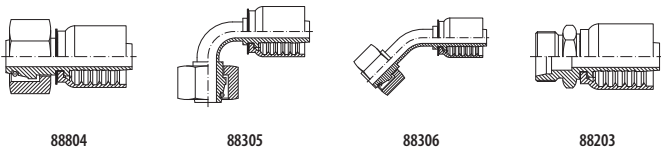

88804

88305

88306

88203

■ Conexiones compactas BSP / One piece BSP fittings / Embouts pré-sertis BSP / Raccordi compatti BSP | 51

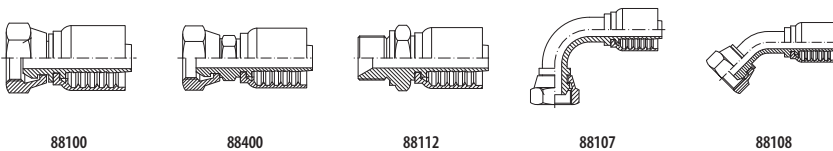

88100

88400

88112

88107

88108

Conexiones Compactas R7/R8 y Elastómero malla metálica

One piece fittings R7/R8 & Elastomer Braid of steel wire
 Embouts pré-sertis R7/R8 et Elastomère tresse métallique
 Raccordi compatti serie R7/R8 e elastomero treccia metallica

■ Conexiones compactas R7/R8 JIC 37° / 37° JIC One piece fittings R7/R8 / Embouts pré-sertis R7/R8 JIC 37° / Raccordi compatti serie R7/R8 JIC sede 37°

52

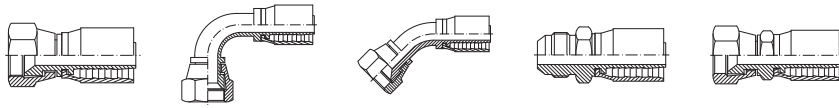

87142

87138

87139

87140

87242

■ Conexiones compactas R7/R8 ORFS / ORFS One piece fittings R7/R8 / Embouts pré-sertis R7/R8 ORFS / Raccordi compatti serie R7/R8 ORFS

53

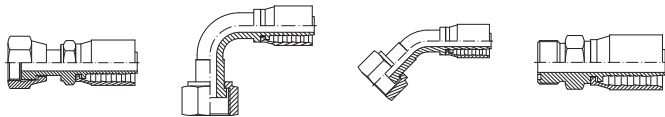

87900

87907

87908

87912

■ Conexiones compactas R7/R8 NPT-NPSM / NPT-NPSM One piece fittings R7/R8 / Embouts pré-sertis R7/R8 NPT-NPSM / Raccordi compatti serie R7/R8 NPT-NPSM

54

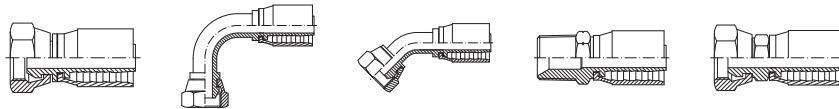

87261

87262

87263

87161

87361

■ Conexiones compactas R7/R8 Métricas / Metric One piece fittings R7/R8 / Embouts pré-sertis R7/R8 Métriques / Raccordi compatti serie R7/R8 Metrici

55

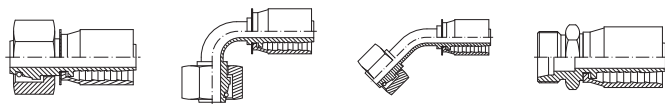

87804

87305

87306

87203

■ Conexiones compactas R7/R8 BSP / BSP One piece fittings R7/R8 / Embouts pré-sertis R7/R8 BSP / Raccordi compatti serie R7/R8 BSP

56

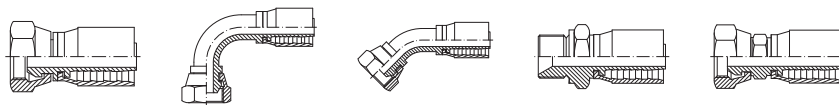

87100

87107

87108

87112

87400

Conexiones Compactas PTFE Liso

One piece fittings for Smooth PTFE
 Embouts pré-sertis pour PTFE lisse
 Raccordi compatti per PTFE liscio

■ Conexiones compactas PTFE liso JIC 37° / 37° JIC One piece fittings smooth PTFE / Embouts pré-sertis PTFE lisse JIC 37° / Raccordi compatti serie PTFE liscio JIC 37° | 57

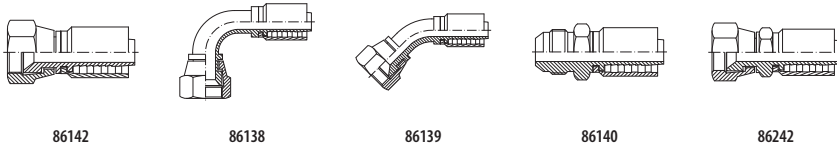

86142

86138

86139

86140

86242

■ Conexiones compactas PTFE liso ORFS / ORFS One piece fittings smooth PTFE / Embouts pré-sertis PTFE lisse ORFS / Raccordi compatti serie PTFE liscio ORFS | 58

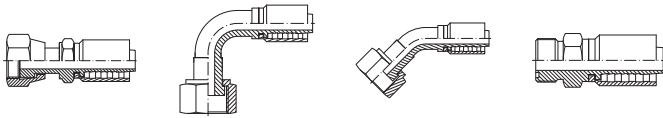

86900

86907

86908

86912

■ Conexiones compactas PTFE liso NPT-NPSM / NPT-NPSM One piece fittings smooth PTFE / Embouts pré-sertis PTFE lisse NPT-NPSM / Raccordi compatti serie PTFE liscio NPT-NPSM | 59

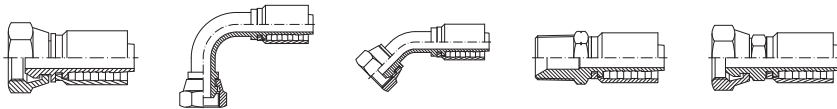

86261

86262

86263

86161

86361

■ Conexiones compactas PTFE liso Métricas / Metric One piece fittings smooth PTFE / Embouts pré-sertis PTFE lisse Métriques / Raccordi compatti serie PTFE liscio Metrici | 60

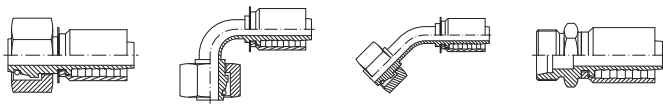

86804

86305

86306

86203

■ Conexiones compactas PTFE liso BSP / BSP One piece fittings smooth PTFE / Embouts pré-sertis PTFE lisse BSP / Raccordi compatti serie PTFE liscio BSP | 61

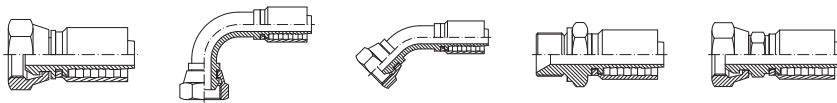

86100

86107

86108

86112

86400

Conexiones Compactas PTFE Corrugado

One piece fittings for convoluted PTFE
 Embouts pré-sertis pour PTFE convoluté
 Raccordi compatti per PTFE convoluto

■ Conexiones compactas PTFE Corrugado JIC 37° / One piece fittings for convoluted PTFE JIC 37° / Embouts pré-sertis pour PTFE convoluté JIC 37° / Raccordi compatti serie PTFE convoluto JIC 37°

62

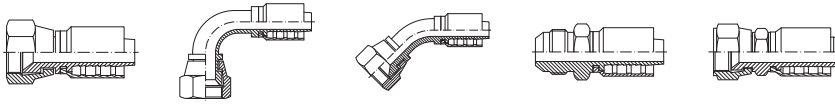

85142

85138

85139

85140

85242

■ Conexiones compactas PTFE Corrugado ORFS / One piece fittings for convoluted PTFE ORFS / Embouts pré-sertis pour PTFE convoluté ORFS / Raccordi compatti serie PTFE convoluto ORFS

63

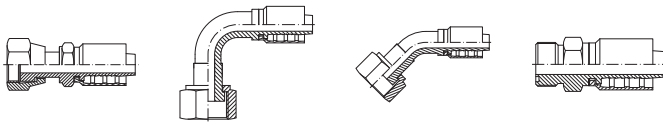

85900

85907

85908

85912

■ Conexiones compactas PTFE Corrugado NPT-NPSM / One piece fittings for convoluted PTFE NPT / Embouts pré-sertis pour PTFE convoluté NPT-NPSM / Raccordi compatti serie PTFE convoluto NPT

64

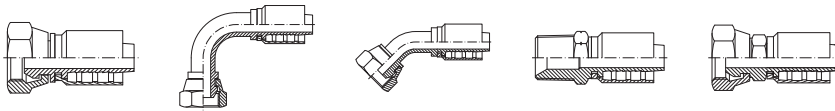

85261

85262

85263

85161

85361

■ Conexiones compactas PTFE Corrugado Métricas / One piece fittings for convoluted PTFE Metric / Embouts pré-sertis pour PTFE convoluté Métriques / Raccordi compatti serie PTFE convoluto METRICI

65

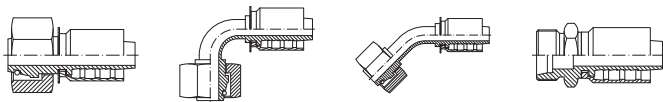

85804

85305

85306

85203

■ Conexiones compactas PTFE Corrugado BSP / One piece fittings for convoluted PTFE BSP / Embouts pré-sertis pour PTFE convoluté BSP / Raccordi compatti serie PTFE convoluto BSP

66

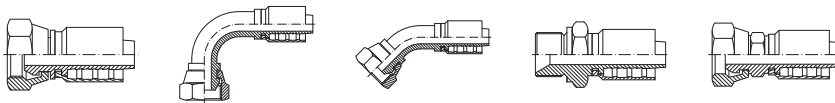

85100

85107

85108

85112

85400

Conexiones Compactas Serie BW R12/4SP/4SH

One piece fittings BW Series R12/4SP/4SH
 Embouts pré-sertis R12/4SP/4SH Série BW
 Raccordi Compatti R12/4SP/4SH Serie BW

■ Conexiones compactas JIC 37° / One piece JIC 37° fittings / Embouts pré-sertis JIC / Raccordi compatti JIC 37° | 67

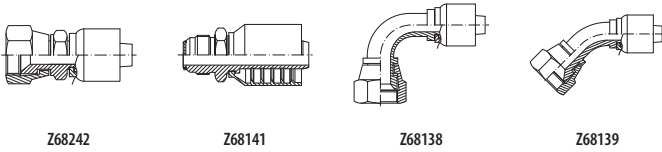

Z68242

Z68141

Z68138

Z68139

■ Conexiones compactas NPT/NPSM / One piece NPT/NPSM fittings / Embouts pré-sertis NPT/NPSM / Raccordi compatti NPT/NPSM | 67

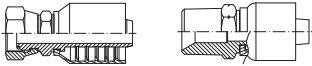

Z68461

Z68161

■ Conexiones compactas ORFS / One piece ORFS fittings / Embouts pré-sertis ORFS / Raccordi compatti ORFS | 68

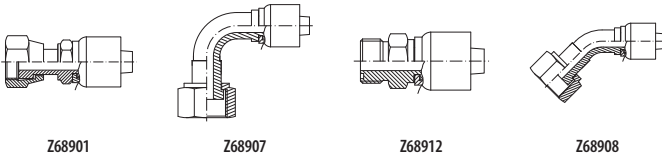

Z68901

Z68907

Z68912

Z68908

■ Conexiones compactas Métricas DIN 2353 / One piece Metric fittings / Embouts pré-sertis Métriques / Raccordi compatti Metrici | 68

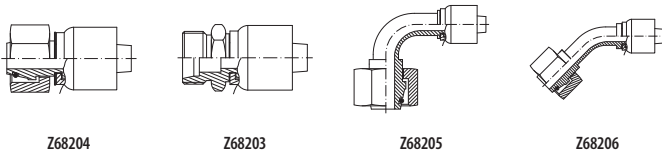

Z68204

Z68203

Z68205

Z68206

■ Conexiones compactas BSP / One piece BSP fittings / Embouts pré-sertis BSP / Raccordi compatti BSP | 69

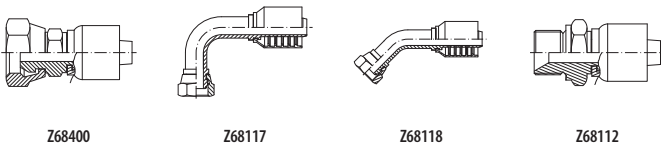

Z68400

Z68117

Z68118

Z68112

■ Conexiones compactas Bridas SAE / One piece SAE Flanges / Brides SAE pré-serties / Flange SAE compatta | 70

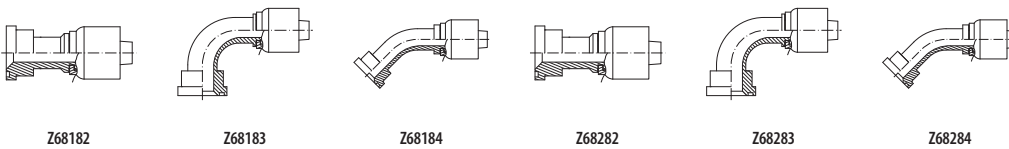

Z68182

Z68183

Z68184

Z68282

Z68283

Z68284

Casquillos para Conexiones Compactas

Ferrules for one piece fittings
Jupes pour embouts pré-sertis
Boccole per raccordi compatti

■ Casquillos para Conexiones Compactas / Ferrules for one piece fittings / Jupes pour embouts pré-sertis / Boccole per raccordi compatti

71

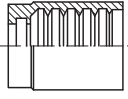

ZPFC2212

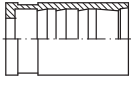

88012

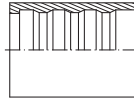

88040

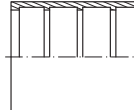

88041

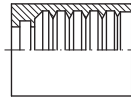

ZSCC2112

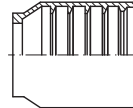

ZAC68010

Pipe fittings DIN 2353

Flare fittings JIC 37° / SAE Flanges

Adaptors

Welding fittings

Industrial fittings

Couplings, Ball valves and Hydraulic Components

Conexiones Reusables

Reusable series
Emboutis série récupérable
Serie Recuperabile

■ Casquillos reusables / Crimp ferrules / Jupes à sertir / Boccole a pressare

72

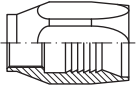

Z1G...R1

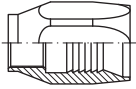

Z1G...R1T

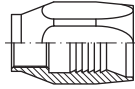

Z1G...R2

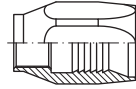

Z1G...R2T

■ Conexiones / Fittings / Embouts / Raccordi

72

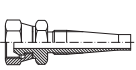

Z3G

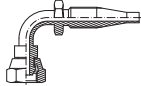

Z90G

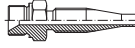

Z2G



ZE

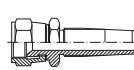

Z3J

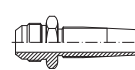

Z2J

Conexiones Push-On

Push-On Fittings
Embouts Push-On
Raccordi Serie Push-On

■ Conexiones Push-On BSP / Push-on BSP fittings / Embouts Push-on BSP / Raccordi Serie Push-on BSP

74

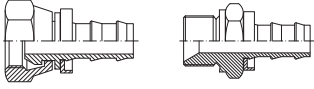

89100

89112

■ Conexiones Push-On JIC 37° / Push-on 37° JIC fittings / Embouts Push-on JIC 37° / Raccordi Serie Push-on JIC 37°

74

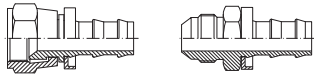

89142

89140

■ Conexiones Push-On NPT / Push-on NPT fittings / Embouts Push-on NPT / Raccordi Serie Push-on NPT

74

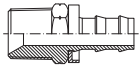

89161

■ Conexiones Push-On Métricas DIN 2383 / Push-on Metric fittings / Embouts Push-on Métriques / Raccordi Serie Push-on Metrici

74

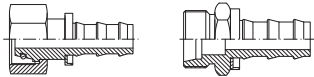

89804

89203

Conexiones Alta Presión (700 bar)

High pressure 700 bar fittings
 Embouts haute pression 700 bar
 Raccordi Altissima pressione (700 bar)

■ Casquillos para prensar / Ferrules / Jupes à sertir / Boccole

75

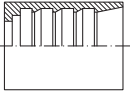

Z71012

■ Conexiones BSP / BSP Fittings / Embouts BSP / Raccordi BSP

75

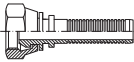

Z74100

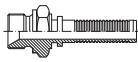

Z74112

■ Conexiones NPSM / NPT / NPSM / NPT Fittings / Embouts NPSM / NPT / Raccordi NPSM / NPT

75



Z74261

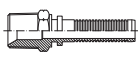

Z74161

■ Conexiones JIC 37° / JIC 37° Fittings / Embouts JIC 37° / Raccordi JIC 37°

75



Z74142

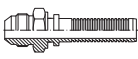

Z74140

■ Conexiones Métricas / Metric Fittings / Embouts / Raccordi Metrici

76

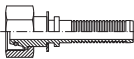

Z74804

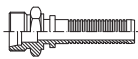

Z74203

Conexiones Micro-hose

Micro-hose fittings
Embouts Minimes
Raccordi Micro-tubo

■ Conexiones Micro-hose / Micro-hose fittings / Embouts Minimes / Raccordi Micro-tubo

77

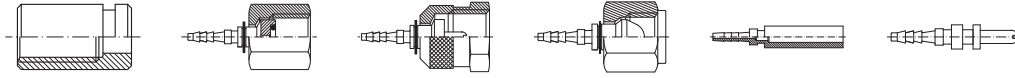

Z55501

Z55505

Z55506

Z55504

Z55507

Z55503

■ Racores de Control / Checking fittings / Prises de contrôle / Prese di pressione

78

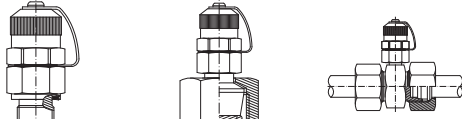

Z MPR

Z MPR TLM

Z MPR DL/S

Conexiones Standard

Standard series
Embouts série standard
Serie Standard

Crimp fittings for hoses

Pipe fittings DIN 2353

Flare fittings JIC 37° / SAE Flanges

Adaptors

Welding fittings

Industrial fittings

Couplings, Ball valves and Hydraulic Components

Casquillos R1AT/R2AT/ 1SN/2SN/ R16/2SC

Ferrules R1AT/R2AT/1SN/2SN/R16/2SC

Jupes R1AT/R2AT/1SN/2SN/R16/2SC

Boccole pressare per R1AT/R2AT/1SN/2SN/ R16/2SC

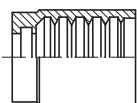

DN	SERIE	Part n° Referencia	€
3/16"	R1AT	810200300	8,47
3/16"	R2AT	810300300	8,47
1/4"	--	ZPF221200400	7,52
5/16"	--	ZPF221200500	8,43
3/8"	--	ZPF221200600	8,79
1/2"	--	ZPF221200800	10,61
5/8"	--	ZPF221201000	13,94
3/4"	--	ZPF221201200	19,10
1"	--	ZPF221201600	28,19
1"1/4"	--	ZPF221202000	48,26
1"1/2"	--	ZPF221202400	62,26
2"	--	ZPF221203200	85,56

Casquillos R1A-1ST

Ferrules R1A-1ST

Jupes R1A-1ST

Boccole pressare per R1A-1ST

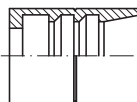

DN	Part n° Referencia	€
3/16"	820030300	9,97
1/4"	820030400	9,24
5/16"	820030500	9,63
3/8"	820030600	10,89
1/2"	820030800	13,06
5/8"	820031000	15,25
3/4"	820031200	19,62
1"	820031600	28,10
1"1/4"	820032000	47,99
1"1/2"	820032400	67,48
2"	820033200	87,73

Casquillos 1SC/1SN/2SC/R6

Ferrules 1SC/1SN/2SC/R6

Jupes 1SC/1SN/2SC/R6

Boccole pressare per 1SC/1SN/2SC/R6

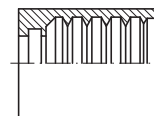

DN	Part n° Referencia	€
1/4"	ZSC21120400	8,95
5/16"	ZSC21120500	9,01
3/8"	ZSC21120600	10,50
1/2"	ZSC21120800	11,60
5/8"	ZSC21121000	15,18
3/4"	ZSC21121200	21,85
1"	ZSC21121600	29,85

Casquillos R2A-2ST/4SP DIN 20023 / R12

Ferrules R2A-2ST/DIN 20023 4SP R9R / R12

Jupes R2A-2ST/4SP DIN 20023 / R12

Boccole pressare per R2A-2ST/4SP DIN 20023 / R12

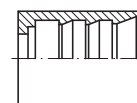

DN	SERIE	Part n° Referencia	€
3/16"	R2A	820060300	8,81
1/4"	--	ZPF122400400	8,61
5/16"	--	ZPF122400500	9,20
3/8"	--	ZPF122400600	9,20
1/2"	--	ZPF122400800	10,82
5/8"	--	ZPF122401000	14,67
3/4"	--	ZPF122401200	18,79
1"	--	ZPF122401600	28,38
1"1/4"	--	ZPF122402000	48,18
1"1/2"	--	ZPF122402400	65,87
2"	--	ZPF122403200	89,33

Casquillos R7/R8 y elastómero malla metálica / 2TE

Ferrules R7/R8 and braid with steel braid / 2TE

Jupes R7/R8 et tresse métallique / 2TE

Boccole pressare per R7/R8 e elastomero treccia metallica / 2TE

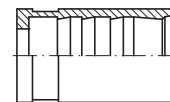

DN	Part n° Referencia	€
1/8"	810140200	7,20
3/16"	810140300	7,24
1/4"	810140400	7,12
5/16"	810140500	7,30
3/8"	810140600	8,22
1/2"	810140800	10,34
5/8"	810141000	15,94
3/4"	810141200	14,94
1"	810141600	24,06

Conexiones Standard

Standard series
Embouts série standard
Serie Standard

Casquillos PTFE Liso

Ferrules for smooth PTFE

Jupes PTFE lisse

Boccole pressare per PTFE liscio

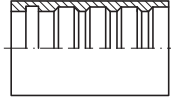

DN	Part n° Referencia	€
3/16"	810400300	7,61
1/4"	810400400	6,16
5/16"	810400500	6,90
3/8"	810400600	6,18
1/2"	810400800	7,85
5/8"	810401000	10,01
3/4"	810401200	11,89
7/8"	810401400	24,13
1"	810401600	19,61
1"1/8	810401800	26,36

Casquillos para mangueras Ecology y Limpieza de Alcantarillas

Ferrules for Ecology hose and Sewer Jetting hose

Jupes pour tuyau Ecology et tuyau Hydrocurage

Boccole pressare per tubi Ecology e pulizia fossa biologica

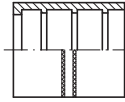

DN	Part n° Referencia	€
3/4"	Z212001200	32,86
1"	Z212001600	45,16
1"1/4	Z212002000	69,08

Casquillos PTFE Corrugado

Ferrules for convoluted PTFE

Jupes PTFE convoluté

Boccole pressare per PTFE corrugato

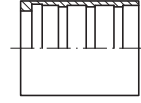

DN	Part n° Referencia	€
1/4"	810410400	7,39
5/16"	810410500	6,43
3/8"	810410600	7,31
1/2"	810410800	9,14
5/8"	810411000	12,46
3/4"	810411201	14,64
1"	810411600	24,02
1"1/4	810412000	38,30
1"1/2	810412400	50,54
2"	810413200	88,96
2"1/2	810414000	109,25

Casquillos R4

Ferrules R4

Jupes R4

Boccole pressare per R4

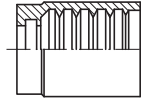

DN	SERIE	Part n° Referencia	€
3/4"	--	ZPF221201200R4	22,50

Para otros tamaños ver tabla de prensado en nuestra web. / For other sizes, please see the crimping table on our website. / Pour d'autres dimensions, consultez la table de sertissage dans notre website. / Per altre misure, consultare la tabella di pressatura sul nostro sito web.

Conexiones Standard

Standard series
Embouts série standard
Serie Standard

Hembras giratorias rectas rosca BSP cono 60°

BSP Swivel female 60° cone

Femelle gaz cylindrique BSP 60°

Femmina diritta BSP sede 60°

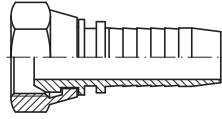

DN	THREAD ROSCA	Part n° Referencia	€
1/8"	1/8" BSP	841000202	15,16
3/16"	1/8" BSP	841000203	12,17
1/4"	1/8" BSP	841000204	12,17
3/16"	1/4" BSP	841000403	11,62
1/4"	1/4" BSP	841000404	9,63
5/16"	1/4" BSP	841000405	14,19
3/8"	1/4" BSP	841000406	14,46
1/4"	3/8" BSP	841000604	13,79
5/16"	3/8" BSP	841000605	13,92
3/8"	3/8" BSP	841000606	11,21
1/2"	3/8" BSP	841000608	18,40
3/8"	1/2" BSP	841000806	17,41
1/2"	1/2" BSP	841000808	14,30
5/8"	1/2" BSP	841000810	24,54
1/2"	5/8" BSP	841001008	24,74
5/8"	5/8" BSP	841001010	25,65
1/2"	3/4" BSP	841001208	26,32
5/8"	3/4" BSP	841001210	25,66
3/4"	3/4" BSP	841001212	23,55
3/4"	1" BSP	841001612	37,25
1"	1" BSP	841001616	37,04
1"	1 1/4" BSP	841002016	66,37
1 1/4"	1 1/4" BSP	841002020	58,87
1 1/4"	1 1/2" BSP	841002420	85,96
1 1/2"	1 1/2" BSP	841002424	85,49
1 1/2"	2" BSP	841003224	159,92
2"	2" BSP	841003232	136,80

Hembras giratorias rectas rosca BSP cono 60° con junta tórica

BSP Swivel female 60° cone with o-ring

Femelle gaz cylindrique BSP 60° avec o-ring

Femmina diritta BSP sede 60° con o'ring

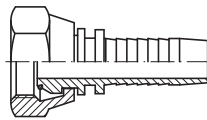

DN	THREAD ROSCA	Part n° Referencia	€
1/4"	1/4" BSP	841100404	11,07
3/8"	3/8" BSP	841100606	12,89
3/8"	1/2" BSP	841100806	20,02
1/2"	1/2" BSP	841100808	16,46
1/2"	3/4" BSP	841101208	30,26
5/8"	3/4" BSP	841101210	29,51
3/4"	3/4" BSP	841101212	27,08
1"	1" BSP	841101616	42,60
1 1/4"	1 1/4" BSP	841102020	67,70
1 1/2"	1 1/2" BSP	841102424	98,31
2"	2" BSP	841103232	157,32

Hembras giratorias rectas rosca BSP asiento plano

BSP Swivel female flat seat

Femelle fond plat BSP

Femmina BSP sede piana

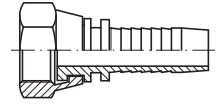

DN	THREAD ROSCA	Part n° Referencia	€
1/4"	1/4" BSP	842000404	10,59
1/4"	3/8" BSP	842000604	15,17
5/16"	3/8" BSP	842000605	15,31
3/8"	3/8" BSP	842000606	12,33
1/2"	3/8" BSP	842000608	20,24
1/4"	1/2" BSP	842000804	31,14
3/8"	1/2" BSP	842000806	19,15
1/2"	1/2" BSP	842000808	15,73
1/2"	3/4" BSP	842001208	28,95
5/8"	3/4" BSP	842001210	28,23
3/4"	3/4" BSP	842001212	25,91
1"	1" BSP	842001616	40,74
1"	1 1/4" BSP	842002016	73,01
1 1/4"	1 1/4" BSP	842002020	64,76
1 1/2"	1 1/2" BSP	842002424	94,04
2"	2" BSP	842003232	150,48

Hembras giratorias 90° compactas rosca BSP cono 60°

BSP swivel female 60° (90° Compact Elbow)

Femelle coudé 90° compact BSP cone 60°

Femmina 90° BSP compatta

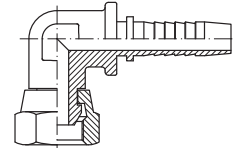

DN	THREAD ROSCA	Part n° Referencia	€
1/4"	1/4" BSP	841270404	48,09
3/8"	3/8" BSP	841270606	52,14
1/2"	1/2" BSP	841270808	60,26
3/4"	3/4" BSP	841271212	96,65
1"	1" BSP	841271616	135,50

Hembras giratorias rectas rosca BSP cono 60° doble hexagonal

Double hexagonal BSP Swivel female cone 60°

Femelle BSP cone 60° double hexagonal

Femmina diritta BSP sede 60° doppio esagono

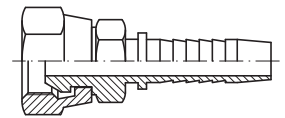

DN	THREAD ROSCA	Part n° Referencia	€
1/4"	1/4" BSP	844000404	17,41
5/16"	3/8" BSP	844000605	20,67
3/8"	3/8" BSP	844000606	18,78
1/2"	1/2" BSP	844000808	23,00
3/4"	3/4" BSP	844001212	38,97
1"	1" BSP	844001616	62,00
1 1/4"	1 1/4" BSP	844002020	83,43
1 1/2"	1 1/2" BSP	844002424	130,45
2"	2" BSP	844003232	226,93

Conexiones Standard

Standard series
Embouts série standard
Serie Standard

Hembras giratorias 90° rosca BSP cono 60°

BSP Swivel female 60° cone (90° Elbow)

Coude 90° femelle gaz cyl. BSP 60°

Femmina 90° BSP sede 60°

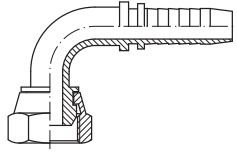

DN	THREAD ROSCA	Part nº Referencia	€
3/16"	1/8" BSP	841070203 *	29,00
3/16"	1/4" BSP	841070403	23,13
1/4"	1/4" BSP	841070404	18,56
5/16"	1/4" BSP	841070405	29,87
1/4"	3/8" BSP	841070604	28,47
5/16"	3/8" BSP	841070605	27,56
3/8"	3/8" BSP	841070606	20,36
1/4"	1/2" BSP	841070804	42,02
3/8"	1/2" BSP	841070806	32,40
1/2"	1/2" BSP	841070808	26,64
5/8"	5/8" BSP	841071010	47,16
1/2"	3/4" BSP	841071208	48,59
5/8"	3/4" BSP	841071210	51,12
3/4"	3/4" BSP	841071212	44,44
3/4"	1" BSP	841071612	66,56
1"	1" BSP	841071616	66,06
1"1/4	1"1/4 BSP	841072020	117,69
1"1/2	1"1/2 BSP	841072424	149,38
2"	2" BSP	841073232	268,03

*841070203 es soldada. / *841070203 is welded. / *841070203 est soudé. / *841070203 è soldata.

Hembras giratorias 90° rosca BSP asiento plano

BSP Swivel female flat seat (90° Elbow)

Coude 90° femelle fond plat BSP

Femmina 90° BSP sede piana

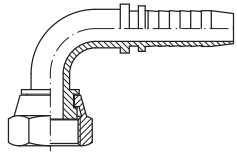

DN	THREAD ROSCA	Part nº Referencia	€
1/4"	1/4" BSP	842070404	23,47
5/16"	3/8" BSP	842070605	31,17
3/8"	3/8" BSP	842070606	27,49
1/2"	1/2" BSP	842070808	35,11
3/4"	3/4" BSP	842071212	49,40
3/4"	1" BSP	842071612	80,51
1"	1" BSP	842071616	77,05
1"1/4	1"1/4 BSP	842072020	152,53
1"1/2	1"1/2 BSP	842072424	175,85
2"	2" BSP	842073232	353,16

Hembras giratorias 45° rosca BSP cono 60°

BSP Swivel female 60° cone (45° Elbow)

Coude 45° femelle gaz cyl. BSP 60°

Femmina 45° BSP sede 60°

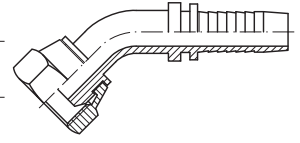

DN	THREAD ROSCA	Part nº Referencia	€
3/16"	1/4" BSP	841080403	23,13
1/4"	1/4" BSP	841080404	18,56
1/4"	3/8" BSP	841080604	28,47
5/16"	3/8" BSP	841080605	27,56
3/8"	3/8" BSP	841080606	20,36
1/4"	1/2" BSP	841080804	42,02
3/8"	1/2" BSP	841080806	32,40
1/2"	1/2" BSP	841080808	26,64
5/8"	5/8" BSP	841081010	47,16
1/2"	3/4" BSP	841081208	48,59
5/8"	3/4" BSP	841081210	51,12
3/4"	3/4" BSP	841081212	44,44
3/4"	1" BSP	841081612	66,56
1"	1" BSP	841081616	66,06
1"1/4	1"1/4 BSP	841082020	117,69
1"1/2	1"1/2 BSP	841082424	149,38
2"	2" BSP	841083232	268,03

Hembras giratorias 45° rosca BSP asiento plano

BSP Swivel female flat seat (45° Elbow)

Coude 45° femelle fond plat BSP

Femmina 45° BSP sede piana

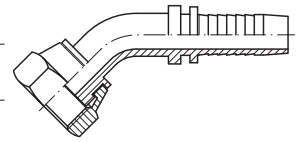

DN	THREAD ROSCA	Part nº Referencia	€
1/4"	1/4" BSP	842080404	23,47
5/16"	3/8" BSP	842080605	31,17
3/8"	3/8" BSP	842080606	27,49
3/8"	1/2" BSP	842080806	38,63
1/2"	1/2" BSP	842080808	35,11
3/4"	3/4" BSP	842081212	49,40
3/4"	1" BSP	842081612	80,51
1"	1" BSP	842081616	77,05
1"1/4	1"1/4 BSP	842082020	152,53
1"1/2	1"1/2 BSP	842082424	175,85
2"	2" BSP	842083232	353,16

Conexiones Standard

Standard series
Embouts série standard
Serie Standard

Hembras giratorias 90° rosca BSP cono 60° con junta tórica

BSP Swivel female 60° cone with o-ring (90° Elbow)

Coude 90° femelle gaz cyl. BSP 60° avec o-ring

Femmina 90° BSP sede 60° con o'ring

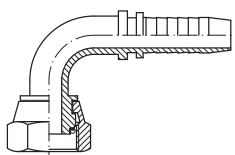

DN	THREAD ROSCA	Part nº Referencia	€
1/4"	1/4" BSP	841170404	26,62
3/8"	3/8" BSP	841170606	31,32
3/8"	1/2" BSP	841170806	41,12
1/2"	1/2" BSP	841170808	38,40
1/2"	3/4" BSP	841171208	62,71
5/8"	3/4" BSP	841171210	53,30
3/4"	3/4" BSP	841171212	54,71
1"	1" BSP	841171616	80,16
1"1/4"	1"1/4 BSP	841172020	140,09
1"1/2"	1"1/2 BSP	841172424	188,35
2"	2" BSP	841173232	423,95

Hembras giratorias 45° rosca BSP cono 60° con junta tórica

BSP Swivel female 60° cone with o-ring (45° Elbow)

Coude 45° femelle gaz cyl. BSP 60° avec o-ring

Femmina 45° BSP sede 60° con o'ring

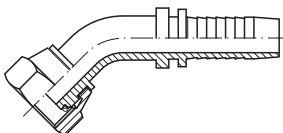

DN	THREAD ROSCA	Part nº Referencia	€
1/4"	1/4" BSP	841180404	26,62
3/8"	3/8" BSP	841180606	31,32
3/8"	1/2" BSP	841180806	41,12
1/2"	1/2" BSP	841180808	38,40
3/4"	3/4" BSP	841181208	62,71
5/8"	3/4" BSP	841181210	53,30
3/4"	3/4" BSP	841181212	54,71
1"	1" BSP	841181616	80,16
1"1/4"	1"1/4 BSP	841182020	140,09
1"1/2"	1"1/2 BSP	841182424	188,35
2"	2" BSP	841183232	423,95

Macho rosca cilíndrica BSP asiento plano

BSP Male flat seat

Mâle BSP fond plat

Maschio BSP sede piana

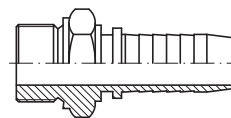

DN	THREAD ROSCA	Part nº Referencia	€
3/16"	1/4" BSP	842120403	19,90
1/4"	1/4" BSP	842120404	13,81
5/16"	3/8" BSP	842120605	17,54
3/8"	3/8" BSP	842120606	15,70
3/8"	1/2" BSP	842120806	20,14
1/2"	1/2" BSP	842120808	18,04
5/8"	5/8" BSP	842121010	28,50
3/4"	3/4" BSP	842121212	24,87
3/4"	1" BSP	842121612	42,03
1"	1" BSP	842121616	40,29
1"	1" 1/4 BSP	842122016	92,47
1"1/4"	1"1/4 BSP	842122020	82,39
1"1/2"	1"1/2 BSP	842122424	92,54
2"	2" BSP	842123232	149,68

Machos rosca cilíndrica BSP cono 60°

BSP Male-parallel 60° cone

Mâle fixe BSP cône 60°

Maschio BSP cilindrico sede 60°

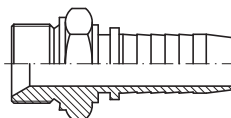

DN	THREAD ROSCA	Part nº Referencia	€
1/4"	1/8" BSP	841120204	14,19
3/16"	1/4" BSP	841120403	19,90
1/4"	1/4" BSP	841120404	10,07
3/8"	1/4" BSP	841120406	15,60
1/4"	3/8" BSP	841120604	18,59
5/16"	3/8" BSP	841120605	15,64
3/8"	3/8" BSP	841120606	11,73
3/8"	1/2" BSP	841120806	17,29
1/2"	1/2" BSP	841120808	16,70
5/8"	5/8" BSP	841121010	29,21
5/8"	3/4" BSP	841121210	26,32
3/4"	3/4" BSP	841121212	24,30
3/4"	1" BSP	841121612	48,24
1"	1" BSP	841121616	40,78
1"	1"1/4 BSP	841122016	81,54
1"1/4"	1"1/4 BSP	841122020	76,29
1"1/4"	1"1/2 BSP	841122420	97,86
1"1/2"	1"1/2 BSP	841122424	90,20
2"	2" BSP	841123232	148,20

Conexiones Standard

Standard series
Embouts série standard
Serie Standard

Machos rosca cónica BSPT cono 60°

Male BSPT tapered

Mâle gaz conique BSPT 60°

Maschio BSPT conico

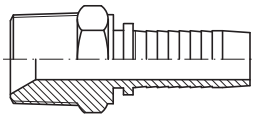

DN	THREAD ROSCA	Part n° Referencia	€
1/4"	1/4" BSPT	841140404	9,62
5/16"	1/4" BSPT	841140405	14,46
3/8"	1/4" BSPT	841140406	17,31
1/4"	3/8" BSPT	841140604	16,18
5/16"	3/8" BSPT	841140605	14,79
3/8"	3/8" BSPT	841140606	12,11
1/2"	3/8" BSPT	841140608	14,00
3/8"	1/2" BSPT	841140806	17,92
1/2"	1/2" BSPT	841140808	15,15
5/8"	1/2" BSPT	841140810	23,94
1/2"	3/4" BSPT	841141208	27,66
5/8"	3/4" BSPT	841141210	25,59
3/4"	3/4" BSPT	841141212	23,83
3/4"	1" BSPT	841141612	39,22
1"	1" BSPT	841141616	35,52
1"	1"1/4 BSPT	841142016	74,69
1"1/4"	1"1/4 BSPT	841142020	63,24
1"1/4"	1"1/2 BSPT	841142420	99,10
1"1/2"	1"1/2 BSPT	841142424	82,80
2"	2" BSPT	841143232	138,84

Macho giratorio NPT

Swivel male NPT

Mâle tournant NPT

Maschio girevole NPT

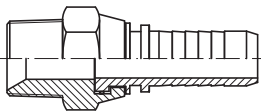

DN	THREAD ROSCA	Part n° Referencia	€
1/4"	1/4" NPT	841650404	*
3/8"	3/8" NPT	841650606	*
1/2"	1/2" NPT	841650808	*
3/4"	3/4" NPT	841651212	*
3/4"	1" NPT	841651612	*
1"	1" NPT	841651616	*

Macho O'Ring Boss

O'Ring Boss Male

Mâle O'Ring Boss

Maschio O'Ring Boss

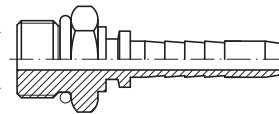

DN	THREAD ROSCA	Part n° Referencia	€
1/4"	7/16"-20h UNF	847120604	15,26
3/8"	9/16"-18h UNF	847121006	16,92
1/2"	3/4"-16h UNF	847121208	19,82
5/8"	7/8"-14h UNF	847121610	24,65
3/4"	1"1/16-12h UN	847122012	49,43
1"	1"5/16-12h UN	847122516	82,78

Juntas para hembra giratoria BSP FKM verde

O'ring for swivel female BSP FKM green

Joint torique pour femelle tournante BSP FKM vert

Guarnizione per femmina girevole BSP FKM verde



THREAD ROSCA	Part n° Referencia	€
1/4" BSP	JTVBSP04	0,16
3/8" BSP	JTVBSP06	0,17
1/2" BSP	JTVBSP08	0,18
5/8" BSP	JTVBSP10	0,18
3/4" BSP	JTVBSP12	0,21
1" BSP	JTVBSP16	0,29
1"1/4 BSP	JTVBSP20	0,43
1"1/2 BSP	JTVBSP24	0,56
2" BSP	JTVBSP32	0,81

Conexiones Standard

Standard series
Embouts série standard
Serie Standard

Hembras giratorias rectas rosca NPSM cono 60° doble hexagonal

Double hexagonal NPSM Swivel female cone 60°

Femelle NPSM cone 60° double hexagonal

Femmina diritta NPSM sede 60° doppio esagono

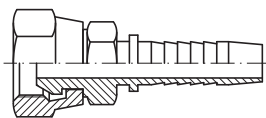

DN	THREAD ROSCA	Part nº Referencia	€
1/4"	1/4" NPSM	843610404	19,14
3/8"	3/8" 18h NPSM	843610606	21,43
1/2"	1/2" 14h NPSM	843610808	29,93
3/4"	3/4" NPSM	843611212	43,64
1"	1" - 11 1/2 h NPSM	843611616	69,44

Hembras giratorias rectas rosca NPSM cono 60°

NPSM Swivel female 60° cone

Femelle NPSM cone 60°

Femmina diritta NPSM sede 60°



DN	THREAD ROSCA	Part nº Referencia	€
1/4"	1/4" 18h NPSM	842610404	12,57
3/8"	3/8" 18h NPSM	842610606	13,05
1/2"	1/2" 14h NPSM	842610808	17,23
3/4"	3/4" 14h NPSM	842611212	27,97
3/4"	1" - 11 1/2h NPSM	842611612	43,48
1"	1" - 11 1/2 h NPSM	842611616	43,23

Hembras giratorias 90° rosca NPSM cono 60°

NPSM Swivel female 60° cone (90° Elbow)

Coude 90° femelle NPSM cone 60°

Femmina 90° NPSM sede 60°

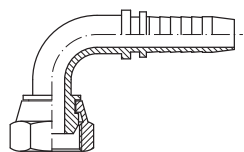

DN	THREAD ROSCA	Part nº Referencia	€
1/4"	1/4" 18h NPSM	842620404	22,36
3/8"	3/8" 18h NPSM	842620606	24,62
1/2"	1/2" 14h NPSM	842620808	29,56
3/4"	3/4" 14h NPSM	842621212	53,51
1"	1" - 11 1/2 h NPSM	842621616	75,00

Hembras giratorias 45° rosca NPSM cono 60°

NPSM Swivel female 60° cone (45° Elbow)

Coude 45° femelle NPSM cone 60°

Femmina 45° NPSM sede 60°

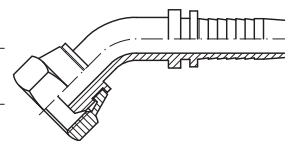

DN	THREAD ROSCA	Part nº Referencia	€
1/4"	1/4" 18h NPSM	842630404	22,36
3/8"	3/8" 18h NPSM	842630606	24,62
1/2"	1/2" 14h NPSM	842630808	29,56
3/4"	3/4" 14h NPSM	842631212	53,51
1"	1" - 11 1/2 h NPSM	842631616	75,00

Machos rosca cónica NPT

NPT Male pipe straight

Embout mâle gaz conique NPT (BRIGGS)

Maschio NPT conico



DN	THREAD ROSCA	Part nº Referencia	€
3/16"	1/8" NPT	841610203 *	16,64
1/4"	1/8" NPT	841610204	15,41
3/16"	1/4" NPT	841610403	14,82
1/4"	1/4" NPT	841610404	9,94
5/16"	1/4" NPT	841610405	15,70
3/8"	1/4" NPT	841610406	17,63
1/4"	3/8" NPT	841610604	13,98
5/16"	3/8" NPT	841610605	12,42
3/8"	3/8" NPT	841610606	11,84
1/2"	3/8" NPT	841610608	13,79
3/8"	1/2" NPT	841610806	18,07
1/2"	1/2" NPT	841610808	16,33
5/8"	1/2" NPT	841610810	17,45
1/2"	3/4" NPT	841611208	26,79
5/8"	3/4" NPT	841611210	24,65
3/4"	3/4" NPT	841611212	23,71
3/4"	1" NPT	841611612	42,41
1"	1" NPT	841611616	38,45
1"	1" 1/4 NPT	841612016	75,08
1" 1/4"	1" 1/4 NPT	841612020	65,28
1" 1/4"	1" 1/2 NPT	841612420	95,09
1" 1/2"	1" 1/2 NPT	841612424	86,71
2"	2" NPT	841613232	138,78

*Hasta fin de existencias. / *Until end of stock. / *Jusqu'à la fin du stock. / *Fino ad esaurimento scorta.

Conexiones Standard

Standard series
Embouts série standard
Serie Standard

Hembras giratorias rectas JIC 37° doble hexagonal

Double hexagonal JIC 37° Swivel female

Femelle JIC 37° double hexagonal

Femmina diritta JIC 37° doppio esagono

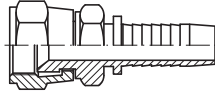

DN	THREAD ROSCA	Part n° Referencia	€
1/4"	7/16" 20h UNF	842420704	14,98
1/4"	1/2" 20h UNF	842420804	16,92
5/16"	9/16" 18h UNF	842420905	21,85
3/8"	9/16" 18h UNF	842420906	16,82
3/8"	3/4" 16h UNF	842421206	21,35
1/2"	3/4" 16h UNF	842421208	20,35
1/2"	7/8" 14h UNF	842421408	31,12
5/8"	7/8" 14h UNF	842421410	32,47
5/8"	1"1/16 12h UN	842421710	33,63
3/4"	1"1/16 12h UN	842421712	32,75
3/4"	1"5/16 12h UN	842422112	51,97
1"	1"5/16 12h UN	842422116	50,86
1"1/4	1"5/8 12h UN	842422620	86,85
1"1/2	1"7/8 12h UN	842423024	149,84
2"	2"1/2 12h UN	842424032	260,45

Hembras giratorias rectas JIC 37°

JIC 37° Swivel female

Femelle droite JIC cone 37°

Femmina diritta JIC sede 37°

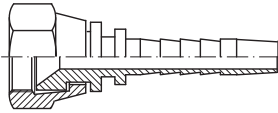

DN	THREAD ROSCA	Part n° Referencia	€
3/16"	7/16" 20h UNF	841420703	14,42
1/4"	7/16" 20h UNF	841420704	11,13
3/16"	1/2" 20h UNF	841420803	15,11
1/4"	1/2" 20h UNF	841420804	12,02
5/16"	1/2" 20h UNF	841420805	13,55
1/4"	9/16" 18h UNF	841420904	14,07
5/16"	9/16" 18h UNF	841420905	13,44
3/8"	9/16" 18h UNF	841420906	12,81
3/8"	3/4" 16h UNF	841421206	17,66
1/2"	3/4" 16h UNF	841421208	16,69
3/8"	7/8" 14h UNF	841421406	19,14
1/2"	7/8" 14h UNF	841421408	19,80
5/8"	7/8" 14h UNF	841421410	21,30
1/2"	1"1/16 12h UN	841421708	36,36
5/8"	1"1/16 12h UN	841421710	25,29
3/4"	1"1/16 12h UN	841421712	25,57
1"	1"1/16 12h UN	841421716	34,73
3/4"	1"5/16 12h UN	841422112	31,62
1"	1"5/16 12h UN	841422116	39,48
1"	1"5/8 12h UN	841422616	58,43
1"1/4	1"5/8 12h UN	841422620	58,52
1"1/4	1"7/8 12h UN	841423020	130,26
1"1/2	1"7/8 12h UN	841423024	104,18
2"	2"1/2 12h UN	841424032	207,68

Hembras giratorias 90° JIC 37°

JIC 37° Swivel female (90° Elbow)

Coude 90° femelle JIC cone 37°

Femmina 90° JIC sede 37°

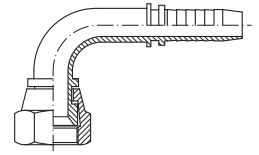

DN	THREAD ROSCA	Part n° Referencia	€
3/16"	7/16" 20h UNF	841380703	26,68
1/4"	7/16" 20h UNF	841380704	22,23
1/4"	1/2" 20h UNF	841380804	27,64
5/16"	1/2" 20h UNF	841380805	29,55
1/4"	9/16" 18h UNF	841380904	32,83
5/16"	9/16" 18h UNF	841380905	29,01
3/8"	9/16" 18h UNF	841380906	23,93
3/8"	3/4" 16h UNF	841381206	32,38
1/2"	3/4" 16h UNF	841381208	25,98
3/8"	7/8" 14h UNF	841381406	32,96
1/2"	7/8" 14h UNF	841381408	31,08
5/8"	7/8" 14h UNF	841381410	37,03
5/8"	1"1/16 12h UN	841381710	42,78
3/4"	1"1/16 12h UN	841381712	46,58
3/4"	1"5/16 12h UN	841382112	71,86
1"	1"5/16 12h UN	841382116	71,59
1"	1"5/8 12h UN	841382616	142,85
1"1/4	1"5/8 12h UN	841382620	122,83
1"1/4	1"7/8 12h UN	841383020	208,31
1"1/2	1"7/8 12h UN	841383024	186,12
2"	2"1/2 12h UN	841384032	449,03

Hembras giratorias 45° JIC 37°

JIC 37° Swivel female (45° Elbow)

Coude 45° femelle JIC cone 37°

Femmina 45° JIC sede 37°

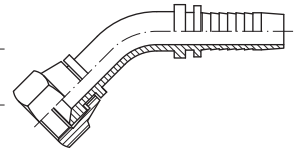

DN	THREAD ROSCA	Part n° Referencia	€
3/16"	7/16" 20h UNF	841390703	26,68
1/4"	7/16" 20h UNF	841390704	22,23
1/4"	1/2" 20h UNF	841390804	27,64
5/16"	1/2" 20h UNF	841390805	29,55
1/4"	9/16" 18h UNF	841390904	32,83
5/16"	9/16" 18h UNF	841390905	29,01
3/8"	9/16" 18h UNF	841390906	23,93
3/8"	3/4" 16h UNF	841391206	32,38
1/2"	3/4" 16h UNF	841391208	25,98
3/8"	7/8" 14h UNF	841391406	32,96
1/2"	7/8" 14h UNF	841391408	31,08
5/8"	7/8" 14h UNF	841391410	37,03
5/8"	1"1/16 12h UN	841391710	42,78
3/4"	1"1/16 12h UN	841391712	46,58
3/4"	1"5/16 12h UN	841392112	71,86
1"	1"5/16 12h UN	841392116	71,59
1"	1"5/8 12h UN	841392616	142,85
1"1/4	1"5/8 12h UN	841392620	122,83
1"1/4	1"7/8 12h UN	841393020	208,31
1"1/2	1"7/8 12h UN	841393024	186,12
2"	2"1/2 12h UN	841394032	449,03

Conexiones Standard

Standard series
Embouts série standard
Serie Standard

Machos rosca JIC cono 37°

Male JIC 37°

Mâle fixe JIC cone 37°

Maschio JIC sede 37°

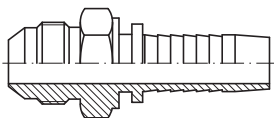

DN	THREAD ROSCA	Part n° Referencia	€
1/4"	7/16" 20h UNF	841400704	14,56
1/4"	1/2" 20h UNF	841400804	14,72
5/16"	1/2" 20h UNF	841400805	16,01
1/4"	9/16" 18h UNF	841400904	16,12
5/16"	9/16" 18h UNF	841400905	16,65
3/8"	9/16" 18h UNF	841400906	16,15
1/4"	3/4" 16h UNF	841401204	32,25
3/8"	3/4" 16h UNF	841401206	16,22
1/2"	3/4" 16h UNF	841401208	18,92
3/8"	7/8" 14h UNF	841401406	21,90
1/2"	7/8" 14h UNF	841401408	19,14
5/8"	7/8" 14h UNF	841401410	22,41
5/8"	1"1/16 12h UN	841401710	28,02
3/4"	1"1/16 12h UN	841401712	25,30
1"	1"1/16 12h UN	841401716	33,06
3/4"	1"5/16 12h UN	841402112	37,18
1"	1"5/16 12h UN	841402116	44,46
1"	1"5/8 12h UN	841402616	79,01
1"1/4"	1"5/8 12h UN	841402620	70,96
1"1/2"	1"7/8 12h UN	841403024	82,91
2"	2"1/2 12h UN	841404032	182,44

Machos rosca JIC cono 37° con junta

Male JIC 37° with o'ring

Mâle fixe JIC cone 37° avec o'ring

Maschio JIC sede 37° con o'ring



DN	THREAD ROSCA	Part n° Referencia	€
1/4"	7/16" 20h UNF	841410704	18,28
3/8"	9/16" 18h UNF	841410906	20,61
1/2"	3/4" 16h UNF	841411208	24,67
3/4"	1"1/16 12h UN	841411712	47,71
1"	1"5/16 12h UN	841412116	60,23
1"1/4"	1"5/8 12h UN	841412620	117,03
1"1/2"	1"7/8 12h UN	841413024	149,56
2"	2"1/2 12h UN	841414032	371,30

Hembras giratorias 90° compactas JIC 37°

JIC 37° Swivel female (90° Compact Elbow)

Femelle coudé 90° compact JIC cone 37°

Femmina 90° JIC sede 37° compatta

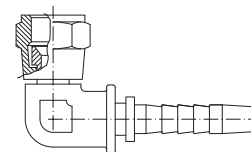

DN	THREAD ROSCA	Part n° Referencia	€
1/4"	7/16" 20h UNF	841370704	53,53
3/8"	9/16" 18h UNF	841370906	54,97
1/2"	3/4" 16h UNF	841371208	62,43
3/4"	1"1/16 12h UN	841371712	102,46
1"	1"5/16 12h UN	841372116	140,27

Conexiones Standard

Standard series
Embouts série standard
Serie Standard

Hembras giratorias rectas rosca Métrica cono 24° con junta tórica - DKO

Metric female swivel with o'ring 24° cone

Femelle Métrique avec o'ring cône 24°

Femmina Metrica sede 24° con o'ring

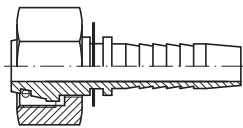

DN	PIPE TUBO	SERIE	THREAD ROSCA	Part nº Referencia	€
3/16"	6	L	M12x1.5	84804120603	14,52
1/4"	6	L	M12x1.5	84804120604	10,90
1/4"	8	L	M14x1.5	84804140804	9,81
1/4"	10	L	M16x1.5	84804161004	13,59
5/16"	10	L	M16x1.5	84804161005	16,52
3/8"	10	L	M16x1.5	84804161006	13,07
1/4"	12	L	M18x1.5	84804181204	15,86
5/16"	12	L	M18x1.5	84804181205	14,48
3/8"	12	L	M18x1.5	84804181206	11,37
3/8"	15	L	M22x1.5	84804221506	17,63
1/2"	15	L	M22x1.5	84804221508	15,10
3/8"	18	L	M26x1.5	84804261806	25,28
1/2"	18	L	M26x1.5	84804261808	25,95
5/8"	18	L	M26x1.5	84804261810	23,17
3/4"	22	L	M30x2	84804302212	29,12
1"	28	L	M36x2	84804362816	42,39
1"1/4	35	L	M45x2	84804453520	72,93
1"1/2	42	L	M52x2	84804524224	93,48
2"	42	L	M52x2	84804524232	175,67
1/4"	6	S	M14x1.5	84804140604	15,12
1/4"	8	S	M16x1.5	84804160804	13,04
1/4"	10	S	M18x1.5	84804181004	12,81
5/16"	10	S	M18x1.5	84804181005	18,83
5/16"	12	S	M20x1.5	84804201205	16,33
3/8"	12	S	M20x1.5	84804201206	16,88
3/8"	14	S	M22x1.5	84804221406	18,22
3/8"	16	S	M24x1.5	84804241606	23,47
1/2"	16	S	M24x1.5	84804241608	17,66
1/2"	20	S	M30x2	84804302008	29,35
5/8"	20	S	M30x2	84804302010	26,84
3/4"	20	S	M30x2	84804302012	40,19
3/4"	25	S	M36x2	84804362512	44,01
1"	25	S	M36x2	84804362516	56,22
1"	30	S	M42x2	84804423016	54,78
1"1/4	38	S	M52x2	84804523820	90,09

Machos rosca Métrica cono 24°

Metric Male stud 24° cone

Mâle metricue cône 24°

Maschio Metrico sede 24°

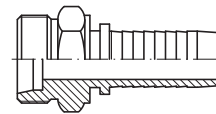

DN	PIPE TUBO	SERIE	THREAD ROSCA	Part nº Referencia	€
1/4"	6	L	M12x1.5	84203120604	13,69
1/4"	8	L	M14x1.5	84203140804	13,26
1/4"	10	L	M16x1.5	84203161004	16,36
5/16"	10	L	M16x1.5	84203161005	16,92
3/8"	10	L	M16x1.5	84203161006	16,28
1/4"	12	L	M18x1.5	84203181204	17,42
5/16"	12	L	M18x1.5	84203181205	16,05
3/8"	12	L	M18x1.5	84203181206	12,79
3/8"	15	L	M22x1.5	84203221506	19,65
1/2"	15	L	M22x1.5	84203221508	16,62
1/2"	18	L	M26x1.5	84203261808	23,62
5/8"	18	L	M26x1.5	84203261810	20,72
3/4"	22	L	M30x2	84203302212	27,86
1"	28	L	M36x2	84203362816	37,72
1"1/4	35	L	M45x2	84203453520	67,35
1"1/2	42	L	M52x2	84203524224	99,99
1/4"	6	S	M14x1.5	84203140604	19,24
1/4"	8	S	M16x1.5	84203160804	16,12
1/4"	10	S	M18x1.5	84203181004	19,36
5/16"	10	S	M18x1.5	84203181005	22,81
3/8"	10	S	M18x1.5	84203181006	19,88
5/16"	12	S	M20x1.5	84203201205	18,98
3/8"	12	S	M20x1.5	84203201206	18,68
3/8"	14	S	M22x1.5	84203221406	21,77
1/2"	14	S	M22x1.5	84203221408	29,78
1/2"	16	S	M24x1.5	84203241608	21,59
5/8"	20	S	M30x2	84203302010	26,74
3/4"	20	S	M30x2	84203302012	29,20
3/4"	25	S	M36x2	84203362512	38,05
1"	25	S	M36x2	84203362516	46,35
1"	30	S	M42x2	84203423016	60,73
1"1/4	38	S	M52x2	84203523820	96,39

Conexiones Standard

Standard series
Embouts série standard
Serie Standard

Hembras giratorias 90° Métricas cono 24° con junta tórica - DKO 90°

Metric swivel female with o'ring 24° cone (90° Elbow)

Coude 90° femelle Metrique cône 24° avec o'ring

Femmina Metrica 90° sede 24° con o'ring

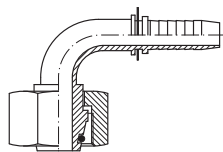

DN	PIPE TUBO	SERIE	THREAD ROSCA	Part nº Referencia	€
3/16"	6	L	M12x1.5	84305120603	28,78
1/4"	6	L	M12x1.5	84305120604	22,98
1/4"	8	L	M14x1.5	84305140804	21,86
1/4"	10	L	M16x1.5	84305161004	24,25
5/16"	10	L	M16x1.5	84305161005	30,08
3/8"	10	L	M16x1.5	84305161006	26,70
1/4"	12	L	M18x1.5	84305181204	32,90
5/16"	12	L	M18x1.5	84305181205	32,03
3/8"	12	L	M18x1.5	84305181206	24,68
1/2"	15	L	M22x1.5	84305221508	27,25
5/8"	18	L	M26x1.5	84305261810	46,14
3/4"	22	L	M30x2	84305302212	52,80
1"	28	L	M36x2	84305362816	77,64
1" 1/4	35	L	M45x2	84305453520	128,04
1" 1/2	42	L	M52x2	84305524224	187,04
1/4"	6	S	M14x1.5	84305140604	25,24
1/4"	8	S	M16x1.5	84305160804	24,89
1/4"	10	S	M18x1.5	84305181004	24,78
5/16"	12	S	M20x1.5	84305201205	32,40
3/8"	12	S	M20x1.5	84305201206	26,47
3/8"	14	S	M22x1.2	84305221406	35,92
1/2"	16	S	M24x1.5	84305241608	30,14
5/8"	20	S	M30x2	84305302010	53,55
3/4"	20	S	M30x2	84305302012	50,90
3/4"	25	S	M36x2	84305362512	75,35
1"	25	S	M36x2	84305362516	86,73
1"	30	S	M42x2	84305423016	105,54
1" 1/4	38	S	M52x2	84305523820	175,35

Hembras giratorias 45° Métricas cono 24° con junta tórica - DKO 45°

Metric swivel female with o'ring 24° cone (45° Elbow)

Coude 45° femelle Metrique cône 24° avec o'ring

Femmina Metrica 45° sede 24° con o'ring

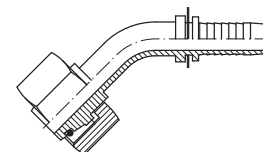

DN	PIPE TUBO	SERIE	THREAD ROSCA	Part nº Referencia	€
3/16"	6	L	M12x1.5	84306120603	28,78
1/4"	6	L	M12x1.5	84306120604	22,98
1/4"	8	L	M14x1.5	84306140804	21,86
1/4"	10	L	M16x1.5	84306161004	24,25
5/16"	10	L	M16x1.5	84306161005	30,08
3/8"	10	L	M16x1.5	84306161006	26,70
1/4"	12	L	M18x1.5	84306181204	32,90
5/16"	12	L	M18x1.5	84306181205	32,03
3/8"	12	L	M18x1.5	84306181206	24,68
1/2"	15	L	M22x1.5	84306221508	27,25
5/8"	18	L	M26x1.5	84306261810	46,14
3/4"	22	L	M30x2	84306302212	52,80
1"	28	L	M36x2	84306362816	77,64
1" 1/4	35	L	M45x2	84306453520	128,04
1" 1/2	42	L	M52x2	84306524224	187,04
3/16"	6	S	M14x1.5	84306140603 *	33,40
1/4"	6	S	M14x1.5	84306140604	25,24
1/4"	8	S	M16x1.5	84306160804	24,89
1/4"	10	S	M18x1.5	84306181004	24,78
5/16"	12	S	M20x1.5	84306201205	32,40
3/8"	12	S	M20x1.5	84306201206	26,47
3/8"	14	S	M22x1.5	84306221406	35,92
1/2"	16	S	M24x1.5	84306241608	30,14
5/8"	20	S	M30x2	84306302010	53,55
3/4"	20	S	M30x2	84306302012	50,90
3/4"	25	S	M36x2	84306362512	75,35
1"	25	S	M36x2	84306362516	86,73
1"	30	S	M42x2	84306423016	105,54
1" 1/4	38	S	M52x2	84306523820	175,35

*Hasta fin de existencias. / *Until end of stock. / *Jusqu'à la fin du stock. / *Fino ad esaurimento scorta.

Conexiones Standard

Standard series
Embouts série standard
Serie Standard

Espigas lisas rectas Métricas

Metric standpipe for DIN 2353 fittings

Embout lisse droit Métrique



Estremità tubolare per raccordi DIN 2353

DN	PIPE TUBO	Part n° Referencia	€
3/16"	6	841580603	9,24
1/4"	6	841580604	7,88
3/16"	8	841580803	8,98
1/4"	8	841580804	7,15
5/16"	8	841580805	8,99
3/8"	8	841580806	10,15
1/4"	10	841581004	8,05
5/16"	10	841581005	8,76
3/8"	10	841581006	7,95
1/4"	12	841581204	11,52
5/16"	12	841581205	11,66
3/8"	12	841581206	8,22
1/2"	12	841581208	12,22
3/8"	14	841581406	11,34
1/2"	14	841581408	14,59
3/8"	15	841581506	13,68
1/2"	15	841581508	10,86
1/2"	16	841581608	11,79
1/2"	18	841581808	12,77
5/8"	18	841581810	15,26
3/4"	18	841581812	22,30
1/2"	20	841582008	17,68
5/8"	20	841582010	16,52
3/4"	20	841582012	19,85
5/8"	22	841582210	17,44
3/4"	22	841582212	18,72
3/4"	25	841582512	23,72
1"	25	841582516	26,80
1"	28	841582816	25,21
1"	30	841583016	28,55
1"1/4	35	841583520	38,96
1"1/4	38	841583820	47,51
1"1/2	42	841584224	53,69

Espigas lisas rectas tubo gas

Gas tube standpipes

Embout lisse tube gaz



Estremità tubolare serie gas

DN	PIPE TUBO	Part n° Referencia	€
1/4"	6.4	841590604	12,38
3/8"	9.5	841590906	12,99
3/8"	12.7	841591206	13,31
1/2"	12.7	841591208	13,91
5/8"	15.8	841591510	18,41

Espigas lisas 90° Métricas

Metric standpipe DIN 2353 fittings (90° Elbow)

Embout lisse coude 90° Métrique

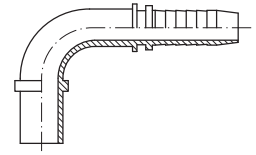

Estremità tubolare 90° per raccordi DIN 2353

DN	PIPE TUBO	Part n° Referencia	€
1/8"	6	842580602	25,95
3/16"	6	842580603	25,95
1/4"	6	842580604	18,51
3/16"	8	842580803	24,66
1/4"	8	842580804	17,26
5/16"	8	842580805	21,66
1/4"	10	842581004	18,43
5/16"	10	842581005	22,26
3/8"	10	842581006	23,02
1/4"	12	842581204	22,02
5/16"	12	842581205	23,26
3/8"	12	842581206	21,36
1/2"	12	842581208	28,17
3/8"	14	842581406	26,52
1/2"	14	842581408	27,47
3/8"	15	842581506	34,90
1/2"	15	842581508	26,58
1/2"	16	842581608	26,45
1/2"	18	842581808	33,67
5/8"	18	842581810	28,50
5/8"	20	842582010	37,05
3/4"	20	842582012	37,39
5/8"	22	842582210	60,16
3/4"	22	842582212	39,33
3/4"	25	842582512	41,04
1"	28	842582816	60,31
1"	30	842583016	68,17

Espigas lisas 90° tubo gas

Gas tube standpipes (90° Elbow)

Embout lisse 90° tube gaz

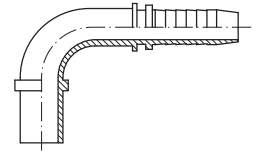

Estremità tubolare 90° serie gas

DN	PIPE TUBO	Part n° Referencia	€
1/4"	6.4	842590604	27,14
3/8"	9.5	842590906	33,38
1/2"	12.7	842591208	34,69

Conexiones Standard

Standard series
Embouts série standard
Serie Standard

Espigas lisas 45° Métricas

Metric standpipe DIN 2353 fittings (45° Elbow)

Embout lisse coude 45° Métrique

Estremità tubolare 45° per raccordi DIN 2353

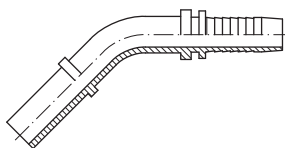

DN	PIPE TUBO	Part nº Referencia	€
3/16"	6	843580603	25,95
1/4"	6	843580604	18,51
3/16"	8	843580803	24,66
1/4"	8	843580804	17,26
5/16"	8	843580805	21,66
1/4"	10	843581004	18,43
5/16"	10	843581005	22,26
3/8"	10	843581006	23,02
1/4"	12	843581204	22,02
5/16"	12	843581205	23,26
3/8"	12	843581206	21,36
1/2"	12	843581208	28,17
3/8"	14	843581406	26,52
1/2"	14	843581408	27,47
3/8"	15	843581506	34,90
1/2"	15	843581508	26,58
1/2"	16	843581608	26,45
1/2"	18	843581808	33,67
5/8"	18	843581810	28,50
5/8"	20	843582010	37,05
1/2"	20	843582012	37,39
5/8"	22	843582210	60,16
3/4"	22	843582212	39,33
3/4"	25	843582512	41,04
1"	28	843582816	60,31
1"	30	843583016	68,17

Espigas de prensar dobles

Double crimp standpipe

Embout double jonction

Giunzione tubo-tubo



DN	Part nº Referencia	€
1/4"	843000404	21,97
5/16"	843000505	24,05
3/8"	843000606	24,15
1/2"	843000808	30,09
3/4"	843001212	45,40
1"	843001616	58,88
1" 1/2	843002424	134,66
1"1/4	843002020	119,30

Espigas lisas 45° tubo gas

Gas tube standpipes (45° Elbow)

Embout lisse 45° tube gaz

Estremità tubolare 45° serie gas

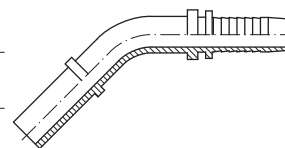

DN	PIPE TUBO	Part nº Referencia	€
1/4"	6.4	843590604	27,14
3/8"	9.5	843590906	33,38
1/2"	12.7	843591208	34,69

Espigas soldables

Welding standpipes

Embout lisse à souder

Inserti a saldare

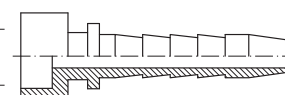

DN	Part nº Referencia	€
1/8"	840000200 *	13,47
3/16"	840000300	13,47
1/4"	840000400	9,84
5/16"	840000500	13,92
3/8"	840000600	13,92
1/2"	840000800	14,04
5/8"	840001000	22,08
3/4"	840001200	22,93
1"	840001600	24,36
1"1/4	840002000	51,87
1"1/2	840002400	61,44
2"	840003200	93,24
2"1/2	840004000	179,18

*Hasta fin de existencias / *Until end of stock. / *Jusqu'à la fin du stock / *Fino ad esaurimento scorta

Conexiones Standard

Standard series
Embouts série standard
Serie Standard

Orientables BSP

Banjo BSP

Banjo droit gaz BSP

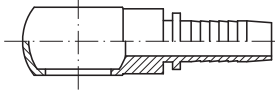

Raccordo ad occhio BSP

DN	Ø	Part n° Referencia	€
1/4"	1/4"	841110404	32,79
5/16"	3/8"	841110605	40,03
3/8"	3/8"	841110606	37,27
1/2"	3/8"	841110608	53,10
3/8"	1/2"	841110806	57,85
1/2"	1/2"	841110808	51,87
3/4"	3/4"	841111212	88,07
1"	1"	841111616	171,31

Tornillo orientable simple BSP

BSP Bolt for banjo

Vis creuse simple pour banjo gaz

Bullone forato BSP

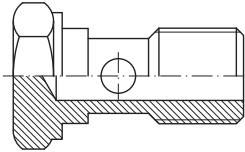

THREAD ROSCA	Part n° Referencia	€
1/4" BSP	Z109004	*
3/8" BSP	Z109006	*
1/2" BSP	Z109008	*
3/4" BSP	Z109012	*
1" BSP	Z109016	*

*Ver precios en p.147 (ADAPTADORES BSP) / *See prices in p.147 (BSP ADAPTORS) / *Prix à la p.147 ADAPTEURS BSP) / *Vedere prezzi p.147 (ADATTATORI BSP)

Orientables Métricos

Banjo Metric

Banjo droit Métrique

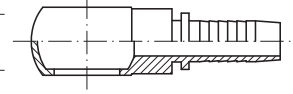

Raccordo ad occhio Metrico

DN	Ø	Part n° Referencia	€
1/4"	M12x1.5	841161204	39,81
1/4"	M14x1.5	841161404	37,80
5/16"	M16x1.5	841161605	49,12
3/8"	M16x1.5	841161606	46,32
3/8"	M18x1.5	841161806	53,26
1/2"	M18x1.5	841161808	65,62
1/2"	M20x1.5	841162008	68,61
1/2"	M22x1.5	841162208	68,61
3/4"	M26x1.5	841162612	82,87

Tornillo orientable simple Métrico

Metric bolt for banjo

Vis creuse simple for banjo Métrique

Bullone forato Metrico

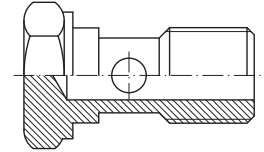

THREAD ROSCA	Part n° Referencia	€
M12X1.5	Z109212	*
M14X1.5	Z109214	*
M16X1.5	Z109216	*
M18X1.5	Z109218	*
M22X1.5	Z109222	*
M26X1.5	Z109226	*
M30X1.5	Z109230	*

*Ver precios en p.147 (ADAPTADORES BSP) / *See prices in p.147 (BSP ADAPTORS) / *Prix à la p.147 (ADAPTEURS BSP) / *Vedere prezzi p.147 (ADATTATORI BSP)

Conexiones Standard

Standard series
Embouts série standard
Serie Standard

Bridas rectas SAE 3000 PSI

3000 PSI SAE Straight Flange / Code 61

Bride SAE droite série 3000 PSI

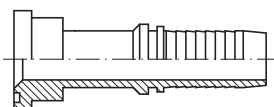

Flangia diritta SAE 3000

DN	Ø	Part n° Referencia	€
1/2"	30,2	841820808	40,06
1/2"	38,1	841821208	66,89
5/8"	38,1	841821210	57,66
3/4"	38,1	841821212	52,24
3/4"	44,5	841821612	66,18
1"	44,5	841821616	65,65
1"	50,8	841822016	93,40
1"1/4	50,8	841822020	102,65
1"1/4	60,3	841822420	141,81
1"1/2	60,3	841822424	130,45
1"1/2	71,4	841823224	228,35
2"	71,4	841823232	217,58

Bridas 90° SAE 3000 PSI

3000 PSI SAE Flange (90° Elbow) / Code 61

Bride SAE coude 90° série 3000 PSI

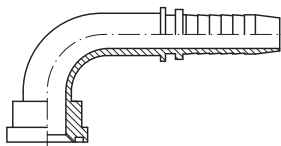

Flangia 90° SAE 3000

DN	Ø	Part n° Referencia	€
1/2"	30,2	841830808	59,50
1/2"	38,1	841831208	77,68
5/8"	38,1	841831210	90,91
3/4"	38,1	841831212	81,72
3/4"	44,5	841831612	119,50
1"	44,5	841831616	122,65
1"	44,5	841831620	151,65
1"	50,8	841832016	170,04
1"1/4	50,8	841832020	157,10
1"1/4	60,3	841832420	249,95
1"1/2	60,3	841832424	236,99
1"1/2	71,4	841833224	376,15
2"	71,4	841833232	353,88

Bridas 45° SAE 3000 PSI

3000 PSI SAE Flange (45° Elbow) / Code 61

Bride SAE coude 45° série 3000 PSI

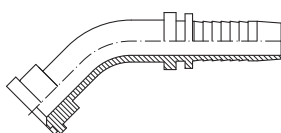

Flangia 45° SAE 3000

DN	Ø	Part n° Referencia	€
1/2"	30,2	841840808	59,50
1/2"	38,1	841841208	77,68
5/8"	38,1	841841210	90,91
3/4"	38,1	841841212	81,72
3/4"	44,5	841841612	119,50
1"	44,5	841841616	122,65
1"	50,8	841842016	170,04
1"1/4	50,8	841842020	157,10
1"1/2	60,3	841842420	249,95
1"1/2	60,3	841842424	239,99
1"1/2	71,4	841843224	376,15
2"	71,4	841843232	353,88

Bridas rectas SAE 6000 PSI

6000 PSI SAE Straight Flange / Code 62

Bride SAE droite série 6000 PSI

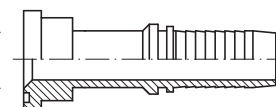

Flangia diritta SAE 6000

DN	Ø	Part n° Referencia	€
1/2"	31,8	842820808	47,11
1/2"	41,3	842821208	75,38
5/8"	41,3	842821210	77,86
3/4"	41,3	842821212	64,38
3/4"	47,6	842821612	76,61
1"	47,6	842821616	75,95
1"	54	842822016	118,42
1"1/4	54	842822020	113,17
1"1/4	63,5	842822420	155,89
1"1/2	63,5	842822424	136,35
1"1/2	79,4	842823224	274,72
2"	79,4	842823232	239,81

Bridas 90° SAE 6000 PSI

6000 PSI SAE Flange (90° Elbow) / Code 62

Bride SAE coude 90° série 6000 PSI

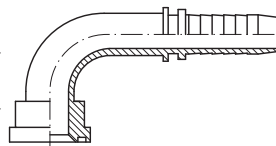

Flangia 90° SAE 6000

DN	Ø	Part n° Referencia	€
1/2"	31,8	842830808	59,71
1/2"	41,3	842831208	81,70
5/8"	41,3	842831210	98,38
3/4"	41,3	842831212	86,69
3/4"	47,6	842831612	121,36
1"	47,6	842831616	122,93
1"	54	842832016	162,14
1"1/4	54	842832020	159,73
1"1/4	63,5	842832420	258,16
1"1/2	63,5	842832424	246,40
1"1/2	79,4	842833224	405,79
2"	79,4	842833232	373,21

Bridas 45° SAE 6000 PSI

6000 PSI SAE Flange (45° Elbow) / Code 62

Bride SAE coude 45° série 6000 PSI

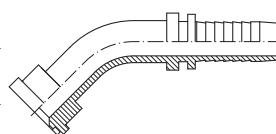

Flangia 45° SAE 6000

DN	Ø	Part n° Referencia	€
1/2"	31,8	842840808	59,71
1/2"	41,3	842841208	81,70
5/8"	41,3	842841210	98,38
3/4"	41,3	842841212	86,69
3/4"	47,6	842841612	121,36
1"	47,6	842841616	122,93
1"	54	842842016	162,14
1"1/4	54	842842020	159,73
1"1/4	63,5	842842420	258,16
1"1/2	63,5	842842424	246,40
1"1/2	79,4	842843224	405,79
2"	79,4	842843232	373,21

Conexiones Standard

Standard series
Embouts série standard
Serie Standard

Brida partida pasante

SAE Split flange

Demi-bride de fixation

Semiflanguia SAE

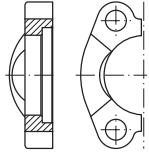

SERIE	Ø INNER Ø INT.	SIZE TAMAÑO	Part n° Referencia	€
3000 PSI	30.2	1/2"	ZBBP308302	13,33
3000 PSI	38.1	3/4"	ZBBP312381	17,20
3000 PSI	44.5	1"	ZBBP316445	20,48
3000 PSI	50.8	1 1/4"	ZBBP320508	29,56
3000 PSI	60.3	1 1/2"	ZBBP324603	38,83
3000 PSI	71.4	2"	ZBBP332714	45,98
3000 PSI	102.4	3"	ZBBP3481024	98,02
6000 PSI	31.8	1/2"	ZBBP608318	16,94
6000 PSI	41.3	3/4"	ZBBP612413	25,76
6000 PSI	47.6	1"	ZBBP616476	37,80
6000 PSI	54	1 1/4"	ZBBP620540	53,52
6000 PSI	63.5	1 1/2"	ZBBP624635	81,08
6000 PSI	79.4	2"	ZBBP632794	138,07

Contrabrida roscada

SAE counter-flange

Contre-bride passage total

Controflanguia SAE

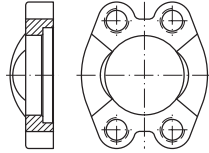

SERIE	Ø	SIZE TAMAÑO	Part n° Referencia	€
3000 PSI	30,2	1/2"	ZBCE308302	55,17
3000 PSI	38,1	3/4"	ZBCE312381	56,36
3000 PSI	44,5	1"	ZBCE316445	58,37
3000 PSI	50,8	1 1/4"	ZBCE320508	71,55
3000 PSI	60,3	1 1/2"	ZBCE324603	84,74
3000 PSI	71,4	2"	ZBCE332714	96,73
6000 PSI	31,8	1/2"	ZBCE608318	61,57
6000 PSI	41,3	3/4"	ZBCE612413	75,95
6000 PSI	47,6	1"	ZBCE616476	85,55
6000 PSI	54	1 1/4"	ZBCE620540	116,26
6000 PSI	63,5	1 1/2"	ZBCE624635	159,88
6000 PSI	79,4	2"	ZBCE632794	228,63

Brida entera pasante

SAE Flange

Bride de fixation monobloc

Flanguia monoblocco SAE

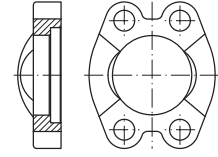

SERIE	Ø INNER Ø INT.	SIZE TAMAÑO	Part n° Referencia	€
3000 PSI	30.2	1/2"	ZBBE308302	13,33
3000 PSI	38.1	3/4"	ZBBE312381	17,20
3000 PSI	44.5	1"	ZBBE316445	20,48
3000 PSI	50.8	1 1/4"	ZBBE320508	29,56
3000 PSI	60.3	1 1/2"	ZBBE324603	38,83
3000 PSI	71.4	2"	ZBBE332714	45,98
6000 PSI	31.8	1/2"	ZBBE608318	16,94
6000 PSI	41.3	3/4"	ZBBE612413	25,76
6000 PSI	47.6	1"	ZBBE616476	37,80
6000 PSI	54	1 1/4"	ZBBE620540	53,52
6000 PSI	63.5	1 1/2"	ZBBE624635	81,08
6000 PSI	79.4	2"	ZBBE632794	138,07

Tornillos para bridas SAE

Screws for SAE flanges

Vis pour brides SAE

Vite per flanguia SAE



THREAD ROSCA	SIZE TAMAÑO	Part n° Referencia	€
M8X30	3000-6000 PSI 1/2"	ZTB8X30	*
M10X35	3000 PSI 3/4"-1"	ZTB10X35	*
M10X40	3000 PSI 1" 1/4 - 6000 PSI 3/4"	ZTB10X40	*
M12X45	3000 PSI 1 1/2-2"-2 1/2-6000 PSI 1"	ZTB12X45	*
M14X45	6000 PSI 1 1/4"	ZTB14X45	*
M16X50	3000 PSI 3"-3 1/2"-4"- 6000 PSI 1 1/2"	ZTB16X50	*
M20X70	6000 PSI 2"	ZTB20X70	*

*Ver precios en p.134 / *See prices p.134 / *Voir prix p.134

Juntas para bridas SAE 3000/6000 PSI

Seals for 3000/6000 PSI flange

Joint pour bride série 3000/6000

Guarnizioni per flanguia SAE 3000/6000 PSI



Ø OUTER Ø EXT.	Ø INNER Ø INT.	SIZE TAMAÑO	HEIGHT (MM) ALTURA (MM)	Part n° Referencia	€
25.40	17.02	1/2"	2.79	JBR08	*
31.72	23.36	3/4"	2.79	JBR12	*
39.62	31.24	1"	2.79	JBR16	*
44.45	36.07	1 1/4"	2.79	JBR20	*
53.98	45.34	1 1/2"	2.79	JBR24	*
63.50	54.86	2"	2.79	JBR32	*

*Ver precios en Conducciones Hidráulicas y Neumáticas / *See prices in Hydraulic and Pneumatic Connectors' Catalogue / *Voir prix dans le Catalogue Connectique Hydraulique et Pneumatique

Conexiones Standard

Standard series
Embouts série standard
Serie Standard

Hembras giratorias rectas ORFS asiento plano

ORFS Swivel female straight

Femelle droite ORFS

Femmina diritta ORFS

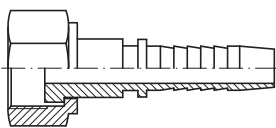

DN	THREAD ROSCA	Part n° Referencia	€
5/8"	1-14	849001610	40,56
3/4"	1 7/16-12	849002312	57,94
1"1/4	1 11/16-12	849002720	122,20

Hasta fin de existencias, después se servirá 84901 / Until end of stocks, then we will send 84901
/ Jusqu'à la fin du stock, après la référence à fournir sera 84901 / Fino ad esaurimento scorte,
dopo utilizzare cod. 84901

Hembras giratorias rectas ORFS doble Hex

Double hexagonal ORFS Swivel female straight

Femelle droite ORFS double hexagonal

Femmina diritta ORFS doppio esagono

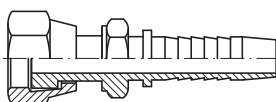

DN	THREAD ROSCA	Part n° Referencia	€
1/4"	9/16-18	849010904	29,43
1/4"	11/16-16	849011104	40,32
5/16"	11/16-16	849011105	39,24
3/8"	11/16-16	849011106	34,60
3/8"	13/16-16	849011306	44,38
1/2"	13/16-16	849011308	39,20
1/2"	1-14	849011608	73,64
5/8"	1-14	849011610	56,82
1/2"	1 3/16-12	849011908	85,50
3/4"	1 3/16-12	849011912	59,66
3/4"	1 7/16-12	849012312	99,45
1"	1 7/16-12	849012316	82,65
1"1/4	1 11/16-12	849012720	152,86
1"1/2	2-12	849013224	190,01

Machos ORFS

ORFS Male

Mâle ORFS

Maschio ORFS

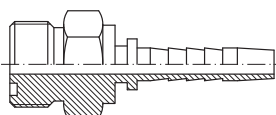

DN	THREAD ROSCA	Part n° Referencia	€
1/4"	9/16-18	849120904	29,50
5/16"	11/16-16	849121105	32,29
3/8"	11/16-16	849121106	32,39
1/2"	13/16-16	849121308	37,99
5/8"	1-14	849121610	62,10
3/4"	1 3/16-12	849121912	74,53
1"	1 7/16-12	849122316	110,75
1"1/4	1 11/16-12	849122720	153,18
1"1/2	2-12	849123224	227,70

Hembras giratorias 90° ORFS

ORFS Swivel female (90° Elbow)

Coude 90° femelle ORFS

Femmina 90° ORFS

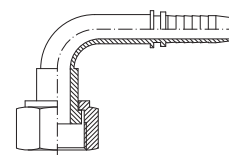

DN	THREAD ROSCA	Part n° Referencia	€
1/4"	9/16-18	849070904	57,79
1/4"	11/16-16	849071104	73,16
5/16"	11/16-16	849071105	71,50
3/8"	11/16-16	849071106	69,29
3/8"	13/16-16	849071306	76,61
1/2"	13/16-16	849071308	74,20
1/2"	1-14	849071608	115,28
5/8"	1-14	849071610	102,01
3/4"	1 3/16-12	849071912	128,35
3/4"	1 7/16-12	849072312	191,27
1"	1 7/16-12	849072316	186,35
1"1/4	1 11/16-12	849072720	261,84
1"1/2	2-12	849073224	753,56

Hembras giratorias 45° ORFS

ORFS Swivel female (45° Elbow)

Coude 45° femelle ORFS

Femmina 45° ORFS

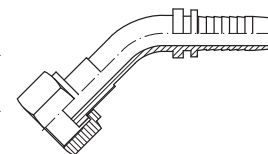

DN	THREAD ROSCA	Part n° Referencia	€
1/4"	9/16-18	849080904	57,79
1/4"	11/16-16	849081104	73,16
5/16"	11/16-16	849081105	71,50
3/8"	11/16-16	849081106	69,29
3/8"	13/16-16	849081306	76,61
1/2"	13/16-16	849081308	74,20
1/2"	1-14	849081608	115,28
5/8"	1-14	849081610	102,01
3/4"	1 3/16-12	849081912	128,35
3/4"	1 7/16-12	849082312	191,27
1"	1 7/16-12	849082316	186,35
1"1/4	1 11/16-12	849082720	261,84
1"1/2	2-12	849083224	753,56

Conexiones Serie BW R12/4SP/4SH No Pelar

Fittings BW Series R12/4SP/4SH No Skiving
Embouts R12/4SP/4SH Série BW Sans dénuder
Raccordi R12/4SP/4SH Serie BW senza pelatura

Casquillos R12/4SP/4SH para conexiones serie BW

Ferrules R12/4SP/4SH for fittings BW series

Jupes R12/4SP/4SH pour embouts série BW

Boccole pressare per R12/4SP/4SH per raccordi serie BW

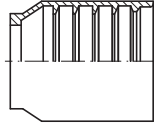

DN	Part n° Referencia	€
1/2"	ZAC680100800	*
5/8"	ZAC680101000	*
3/4"	ZAC680101200	*
1"	ZAC680101600	*
1"1/4	ZAC680102000	*
1"1/2	ZAC680102400	*
2"	ZAC680103200	*

*Ver precios en p.71 / *See prices p.71 / *Voir prix p.71

Hembras giratorias rectas BSP cono 60° doble hexagonal con junta

BSP Swivel female 60° cone double hexagonal with o'ring

Femelle tournante gaz cyl BSP 60° double hexagonale avec o'ring

Femmina diritta BSP sede 60° doppia esagono con o'ring

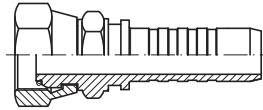

DN	THREAD ROSCA	Part n° Referencia	€
1/2"	1/2" BSP	Z664100808	33,35
5/8"	5/8" BSP	Z664101010	55,17
3/4"	3/4" BSP	Z664101212	56,67
1"	1" BSP	Z664101616	91,68
1"1/4	1"1/4 BSP	Z664102020	187,99
1"1/2	1"1/2 BSP	Z664102424	249,76
2"	2" BSP	Z664103232	509,57

Hembras giratorias rectas BSP cono 60° con junta

BSP Swivel female 60° cone with o'ring

Femelle tournante gaz cyl BSP 60° avec o'ring

Femmina diritta BSP sede 60° con o'ring

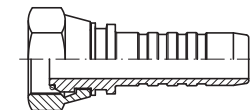

DN	THREAD ROSCA	Part n° Referencia	€
1/2"	1/2" BSP	Z661100808	21,32
5/8"	5/8" BSP	Z661101010	38,25
3/4"	3/4" BSP	Z661101212	37,21
1"	1" BSP	Z661101616	46,57
1"1/4	1"1/4 BSP	Z661102020	77,69
1"1/2	1"1/2 BSP	Z661102424	92,96
2"	2" BSP	Z661103232	150,08

Hembras giratorias 90° BSP cono 60° con junta

BSP Swivel female 60° cone with o'ring (90° Elbow)

Coude 90° femelle tournante gaz cyl BSP 60° avec joint

Femmina a 90° BSP sede 60° con o'ring

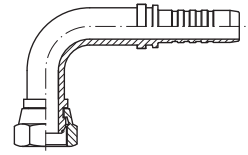

DN	THREAD ROSCA	Part n° Referencia	€
1/2"	1/2" BSP	Z661170808	49,92
5/8"	5/8" BSP	Z661171010	75,11
3/4"	3/4" BSP	Z661171212	56,39
1"	1" BSP	Z661171616	80,79
1"1/4	1"1/4 BSP	Z661172020	124,57
1"1/2	1"1/2 BSP	Z661172424	192,59
2"	2" BSP	Z661173232	344,24

Hembras giratorias 45° BSP cono 60° con junta

BSP Swivel female 60° cone with o'ring (45° Elbow)

Hembras giratorias 45° BSP cono 60° avec o'ring

Femmina a 45° BSP sede 60° con o'ring

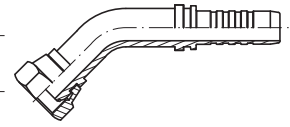

DN	THREAD ROSCA	Part n° Referencia	€
1/2"	1/2" BSP	Z661180808	49,92
5/8"	5/8" BSP	Z661181010	75,11
3/4"	3/4" BSP	Z661181212	56,68
1"	1" BSP	Z661181616	80,37
1"1/4	1"1/4 BSP	Z661182020	123,75
1"1/2	1"1/2 BSP	Z661182424	192,59
2"	2" BSP	Z661183232	344,24

Machos cilíndricos BSP 60°

BSP Male 60° cone

Mâle gaz cylindrique BSP 60°

Maschio BSP cilindrico sede 60°

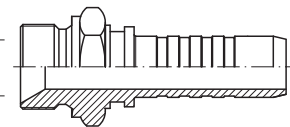

DN	THREAD ROSCA	Part n° Referencia	€
1/2"	1/2" BSP	Z661120808	21,71
5/8"	5/8" BSP	Z661121010	37,97
3/4"	3/4" BSP	Z661121212	41,09
1"	1" BSP	Z661121616	55,74
1"1/4	1"1/4 BSP	Z661122020	97,19
1"1/2	1"1/2 BSP	Z661122424	135,23
2"	2" BSP	Z661123232	266,54

Conexiones Serie BW R12/4SP/4SH No Pelar

Fittings BW Series R12/4SP/4SH No Skiving
Embouts R12/4SP/4SH Série BW Sans dénuder
Raccordi R12/4SP/4SH Serie BW senza pelatura

Hembras giratorias rectas JIC 37°

JIC 37° Swivel female

Femelle JIC 37°

Femmina diritta JIC 37°

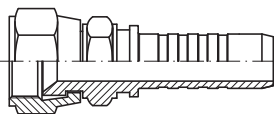

DN	THREAD ROSCA	Part n° Referencia	€
1/2"	3/4" 16h UNF	Z662421208	26,46
5/8"	7/8" 14h UNF	Z662421410	42,21
3/4"	1"1/16 12h UNF	Z662421712	56,64
1"	1"5/16 12h UNF	Z662422116	86,64
1"1/4	1"5/8 12h UNF	Z662422620	208,00
1"1/2	1"7/8 12h UNF	Z662423024	312,53
2"	2"1/2 12h UNF	Z662424032	464,91

Hembras giratorias 90° JIC 37°

JIC 37° Swivel female (90° Elbow)

Coude 90° femelle JIC 37°

Femmina gir. 90° JIC 37°

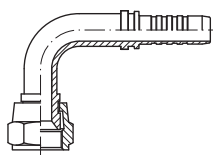

DN	THREAD ROSCA	Part n° Referencia	€
1/2"	3/4" 16h UNF	Z661381208	33,77
5/8"	7/8" 14h UNF	Z661381410	48,14
3/4"	1"1/16 12h UNF	Z661381712	55,54
1"	1"5/16 12h UNF	Z661382116	85,30
1"1/4	1"5/8 12h UNF	Z661382620	126,71
1"1/2	1"7/8 12h UNF	Z661383024	188,90
2"	2"1/2 12h UNF	Z661384032	385,29

Hembras giratorias rectas NPSM cono 60° doble hexagonal con junta

Double hexagonal NPSM female 60° cone with o'ring

Femelle NPSM cone 60° double hexagonal avec joint torique

Femmina diritta NPSM sede 60° doppio esagono con o'ring

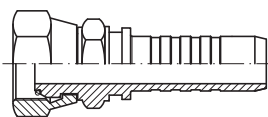

DN	THREAD ROSCA	Part n° Referencia	€
1/2"	1/2" NPSM	Z664610808	35,02
3/4"	3/4" NPSM	Z664611212	59,50
1"	1" NPSM	Z664611616	96,26
1"1/4	1"1/4 NPSM	Z664612020	197,39
1"1/2	1"1/2 NPSM	Z664612424	262,25
2"	2" NPSM	Z664613232	383,33

Hembras giratorias 45° JIC 37°

JIC 37° Swivel female (45° Elbow)

Coude 45° femelle JIC 37°

Femmina gir. 45° JIC 37°

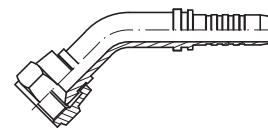

DN	THREAD ROSCA	Part n° Referencia	€
1/2"	3/4" 16h UNF	Z661391208	33,77
5/8"	7/8" 14h UNF	Z661391410	48,14
3/4"	1"1/16 12h UNF	Z661391712	55,54
1"	1"5/16 12h UNF	Z661392116	85,30
1"1/4	1"5/8 12h UNF	Z661392620	126,71
1"1/2	1"7/8 12h UNF	Z661393024	188,90
2"	2"1/2 12h UNF	Z661394032	385,29

Macho JIC 37° con junta

JIC 37° male with o'ring

Mâle JIC 37° avec joint torique

Maschio JIC 37° con o'ring

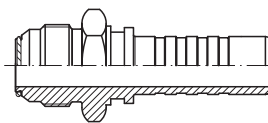

DN	THREAD ROSCA	Part n° Referencia	€
1/2"	3/4" 16h UNF	Z661411208	32,07
5/8"	7/8" 14h UNF	Z661411410	37,99
3/4"	1"1/16 12h UNF	Z661411712	49,73
1"	1"5/16 12h UNF	Z661412116	67,47
1"1/4	1"5/8 12h UNF	Z661412620	93,67
1"1/2	1"7/8 12h UNF	Z661413024	104,99
2"	2"1/2 12h UNF	Z661414032	228,69

Machos cónicos NPT

NPT Male pipe straight

Mâle conique NPT

Maschio conico NPT

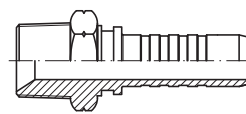

DN	THREAD ROSCA	Part n° Referencia	€
1/2"	1/2" NPT	Z661610808	21,23
3/4"	3/4" NPT	Z661611212	36,14
1"	1" NPT	Z661611616	53,05
1"1/4	1"1/4 NPT	Z661612020	94,17
1"1/2	1"1/2 NPT	Z661612424	135,79
2"	2" NPT	Z661613232	271,82

Conexiones Serie BW R12/4SP/4SH No Pelar

Fittings BW Series R12/4SP/4SH No Skiving
Embouts R12/4SP/4SH Série BW Sans dénuder
Raccordi R12/4SP/4SH Serie BW senza pelatura

Hembra giratoria recta ORFS doble hexagono

ORFS Swivel female straight

Femelle droite ORFS

Femmina diritta ORFS

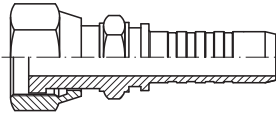

DN	THREAD ROSCA	Part nº Referencia	€
1/2"	13/16-16	Z669011308	50,96
5/8"	1-14	Z669011610	73,87
3/4"	1 3/16-12	Z669011912	77,56
1"	1 7/16-12	Z669012316	113,88
1 1/4"	1 11/16-12	Z669012720	149,11
1 1/2"	2-12	Z669013224	213,47

Hembra giratoria 90° ORFS asiento plano

ORFS Swivel female (90° Elbow)

Coude 90° femelle ORFS

Femmina 90° ORFS

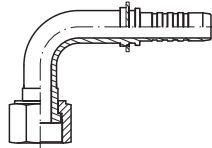

DN	THREAD ROSCA	Part nº Referencia	€
1/2"	13/16-16	Z669071308	96,46
5/8"	1-14	Z669071610	132,61
3/4"	1 3/16-12	Z669071912	218,52
1"	1 7/16-12	Z669072316	318,94
1 1/4"	1 11/16-12	Z669072720	447,20
1 1/2"	2-12	Z669073224	1.289,72

Hembras giratorias Métricas cono 24° con junta tórica

Metric swivel female 24° seat with o'ring

Femelle Métrique 24° avec o'ring

Femmina Metrica sede 24° con o'ring

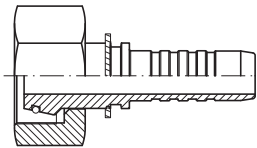

DN	PIPE TUBO	SERIE	THREAD ROSCA	Part nº Referencia	€
1/2"	16	S	M24x1.5	Z66204241608	22,96
3/4"	20	S	M30x2	Z66204302012	46,56
3/4"	25	S	M36X2	Z66204362512	61,42
1"	30	S	M42X2	Z66204423016	67,49
1 1/4"	38	S	M52X2	Z66204523820	100,20

Hembras giratorias 90° Métricas cono 24° con junta tórica

Metric swivel female 24° seat with o'ring (90° Elbow)

Coude 90° femelle Métrique 24° avec o'ring

Femmina Metrica 90° sede 24° con o'ring

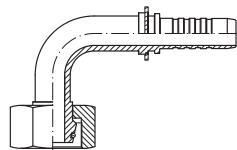

DN	PIPE TUBO	SERIE	THREAD ROSCA	Part nº Referencia	€
1/2"	16	S	M24x1.5	Z66205241608	39,18
3/4"	20	S	M30x2	Z66205302012	66,47
3/4"	25	S	M36X2	Z66205362512	97,96
1"	30	S	M42X2	Z66205423016	123,63
1 1/4"	38	S	M52X2	Z66205523820	162,57

Hembra giratoria 45° ORFS asiento plano

ORFS Swivel female (45° Elbow)

Coude 45° femelle ORFS

Femmina 45° ORFS

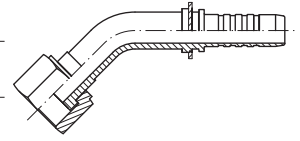

DN	THREAD ROSCA	Part nº Referencia	€
1/2"	13/16-16	Z669081308	96,46
5/8"	1-14	Z669081610	132,61
3/4"	1 3/16-12	Z669081912	218,52
1"	1 7/16-12	Z669082316	318,94
1 1/4"	1 11/16-12	Z669082720	447,20
1 1/2"	2-12	Z669083224	1.311,30

Macho ORFS

ORFS Male

Mâle ORFS

Maschio ORFS

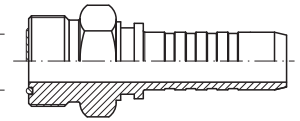

DN	THREAD ROSCA	Part nº Referencia	€
1/2"	13/16-16	Z669121308	49,39
5/8"	1-14	Z669121610	80,73
3/4"	1 3/16-12	Z669121912	128,12
1"	1 7/16-12	Z669122316	190,40
1 1/4"	1 11/16-12	Z669122720	267,40
1 1/2"	2-12	Z669123224	393,54

Hembras giratorias 45° Métricas cono 24° con junta tórica

Metric swivel female 24° seat with o'ring (45° Elbow)

Coude 45° femelle Métrique 24° avec o'ring

Femmina Metrica 45° sede 24°

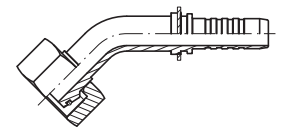

DN	PIPE TUBO	SERIE	THREAD ROSCA	Part nº Referencia	€
1/2"	16	S	M24x1.5	Z66206241608	39,18
3/4"	20	S	M30x2	Z66206302012	67,49
3/4"	25	S	M36X2	Z66206362512	97,96
1"	30	S	M42X2	Z66206423016	123,63
1 1/4"	38	S	M52X2	Z66206523820	162,57

Machos fijos Métricos cono 24°

Metric male stud 24° cone

Mâle Métrique cone 24°

Maschio Metrico sede 24° con o'ring

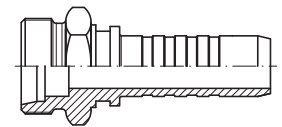

DN	PIPE TUBO	SERIE	THREAD ROSCA	Part nº Referencia	€
1/2"	16	S	M24x1.5	Z66203241608	28,07
3/4"	20	S	M30x2	Z66203302012	49,27
3/4"	25	S	M36X2	Z66203362512	68,84
1"	30	S	M42X2	Z66203423016	78,83
1 1/4"	38	S	M52X2	Z66203523820	135,30

Conexiones Serie BW R12/4SP/4SH No Pelar

Fittings BW Series R12/4SP/4SH No Skiving
Embouts R12/4SP/4SH Série BW Sans dénuder
Raccordi R12/4SP/4SH Serie BW senza pelatura

Brida recta SAE 3000 PSI

3000 PSI SAE Straight Flange / Code 61

Bride SAE droite série 3000 PSI

Flangia diritta SAE 3000



DN	Ø	Part n° Referencia	€
1/2"	30.2	Z661820808	57,28
5/8"	38.1	Z661821210	74,96
3/4"	38.1	Z661821212	60,75
1"	44.5	Z661821616	75,46
1"1/4	50.8	Z661822020	125,74
1"1/2	60.3	Z661822424	160,60
2"	71.4	Z661823232	250,43

Brida recta SAE 6000 PSI

6000 PSI SAE Straight Flange / Code 62

Bride SAE droite série 6000 PSI

Flangia diritta SAE 6000

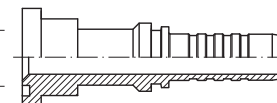

DN	Ø	Part n° Referencia	€
1/2"	31.8	Z662820808	61,24
5/8"	41.3	Z662821210	101,22
3/4"	41.3	Z662821212	69,38
1"	47,63	Z662821616	83,34
1"1/4	53,98	Z662822020	127,62
1"1/2	60.3	Z662822424	162,73
2"	71.4	Z662823232	262,83

Brida a 90° SAE 3000 PSI

3000 PSI SAE Flange (90° Elbow) / Code 61

Bride SAE coude 90° série 3000 PSI

Flangia 90° SAE 3000

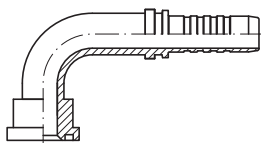

DN	Ø	Part n° Referencia	€
1/2"	30.2	Z661830808	77,35
5/8"	38.1	Z661831210	118,03
3/4"	38.1	Z661831212	87,59
1"	44.5	Z661831616	130,03
1"1/4	50.8	Z661832020	165,77
1"1/2	60.3	Z661832424	280,05
2"	71.4	Z661833232	393,04

Brida a 90° SAE 6000 PSI

6000 PSI SAE Flange (90° Elbow) / Code 62

Bride SAE coude 90° série 6000 PSI

Flangia 90° SAE 6000

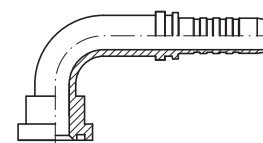

DN	Ø	Part n° Referencia	€
1/2"	31.8	Z662830808	77,62
5/8"	41.3	Z662831210	127,89
3/4"	41.3	Z662831212	93,87
1"	47.6	Z662831616	131,53
1"1/4	54	Z662832020	172,17
1"1/2	63.5	Z662832424	285,65
2"	79.4	Z662833232	406,51

Brida a 45° SAE 3000 PSI

3000 PSI SAE Flange (45° Elbow) / Code 61

Bride SAE coude 45° série 3000 PSI

Flangia 45° SAE 3000

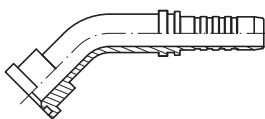

DN	Ø	Part n° Referencia	€
1/2"	30.2	Z661840808	77,35
5/8"	38.1	Z661841210	118,03
3/4"	38.1	Z661841212	87,59
1"	44.5	Z661841616	130,03
1"1/4	50.8	Z661842020	165,77
1"1/2	60.3	Z661842424	280,05
2"	71.4	Z661843232	393,04

Brida a 45° SAE 6000 PSI

6000 PSI SAE Flange (45° Elbow) / Code 62

Bride SAE coude 45° série 6000 PSI

Flangia 45° SAE 6000

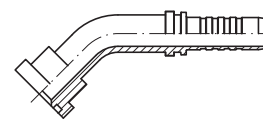

DN	Ø	Part n° Referencia	€
1/2"	31.8	Z662840808	77,62
5/8"	41.3	Z662841210	127,89
3/4"	41.3	Z662841212	93,87
1"	47,6	Z662841616	131,53
1"1/4	54	Z662842020	172,17
1"1/2	63.5	Z662842424	285,65
2"	79.4	Z662843232	406,52

Conexiones Interlock

Interlock series
Embouts Interlock
Serie Interlock

Casquillos Interlock 4SH

Ferrules DIN 20023 - 4SH Interlock

Jupes à sertir DIN 20023 - 4SH Interlock

Boccola pressare per DIN 20023 - 4SH Interlock

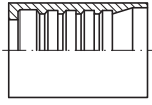

DN	DESCRIPTION DESCRIPCIÓN	Part nº Referencia	€
3/4"	4SH / R13 / R15	ZA610101200	28,08
1"	4SH / R13 / R15	ZA610101600	42,45
1"1/4	4SH	ZA610102000	59,48
1"1/2	4SH	ZA610102400	82,85
2"	4SH	ZA610103200	128,83

Casquillos Interlock R13/R15

Ferrules SAE 100 R13/R15 Interlock

Jupes à sertir R13/R15 Interlock

Boccola pressare per SAE 100 R13/R15 Interlock

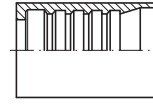

DN	Part nº Referencia	€
1" 1/4	Z610102000	67,22
1"1/2	Z610102400	89,81
2"	Z610103200	118,75

Para 3/4" y 1" son los mismos casquillos que en 4SH / 3/4" and 1" are the same ferrules as in 4SH / 3/4" et 1" sont les mêmes jupes que pour 4SH / Per 3/4" e 1" si utilizza la boccola 4SH

Hembras giratorias rectas rosca BSP cono 60° Interlock

BSP 60° cone Swivel female Interlock

Femelle droite gaz cylindrique BSP 60° Interlock

Femmina diritta BSP sede 60° Interlock

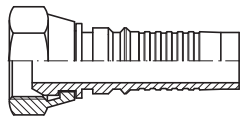

DN	THREAD ROSCA	Part nº Referencia	€
3/4"	3/4" BSP	Z641001212	36,18
1"	1" BSP	Z641001616	44,60
1"1/4	1"1/4 BSP	Z641002020	75,15
1"1/2	1"1/2 BSP	Z641002424	88,44
2"	2" BSP	Z641003232	145,94

Hembras giratorias BSP cono 60° doble hexagonal Interlock

Double hexagonal BSP Swivel female cone 60°

Femelle BSP cone 60° double hexagonal

Femmina diritta BSP sede 60° doppio esagono

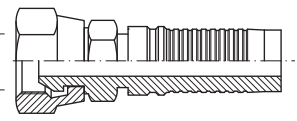

DN	THREAD ROSCA	Part nº Referencia	€
3/4"	3/4" BSP	Z644001212	54,82
1"	1" BSP	Z644001616	87,22
1"1/4	1"1/4 BSP	Z644002020	182,80
1"1/2	1"1/2 BSP	Z644002424	239,19
2"	2" BSP	Z644003232	495,50

Hembras giratoria 90° BSP cono 60° Interlock

BSP 60° cone Swivel female Interlock (90° Elbow)

Coude 90° femelle gaz cylindrique BSP 60° Interlock

Femmina 90° BSP sede 60° Interlock

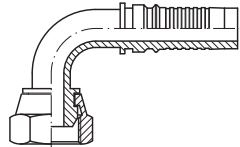

DN	THREAD ROSCA	Part nº Referencia	€
3/4"	3/4" BSP	Z641071212	54,83
1"	1" BSP	Z641071616	78,15
1"1/4	1"1/4 BSP	Z641072020	118,51
1"1/2	1"1/2 BSP	Z641072424	186,29
2"	2" BSP	Z641073232	334,73

Hembras giratoria 45° BSP cono 60° Interlock

BSP 60° cone Swivel female Interlock (45° Elbow)

Coude 45° femelle gaz cylindrique BSP 60° Interlock

Femmina 45° BSP sede 60° Interlock

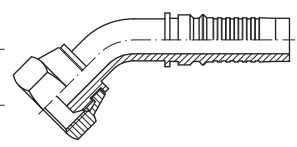

DN	THREAD ROSCA	Part nº Referencia	€
3/4"	3/4" BSP	Z641081212	54,83
1"	1" BSP	Z641081616	78,15
1"1/4	1"1/4 BSP	Z641082020	118,51
1"1/2	1"1/2 BSP	Z641082424	186,29
2"	2" BSP	Z641083232	334,73

Machos cilíndricos BSP cono 60° Interlock

BSP 60° Male cone with Interlock o'ring

Mâle gaz cylindrique BSP 60° Interlock

Maschio BSP cilindrico sede 60° Interlock

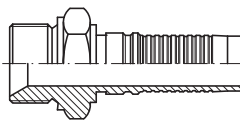

DN	THREAD ROSCA	Part nº Referencia	€
3/4"	3/4" BSP	Z641121212	39,09
1"	1" BSP	Z641121616	53,92
1"1/4	1"1/4 BSP	Z641122020	93,08
1"1/2	1"1/2 BSP	Z641122424	131,50
2"	2" BSP	Z641123232	259,18

Machos cónicos NPT Interlock

NPT Male pipe straight Interlock

Mâle conique NPT Interlock

Maschio conico NPT Interlock

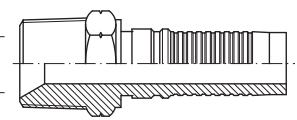

DN	THREAD ROSCA	Part nº Referencia	€
3/4"	3/4" NPT	Z641611212	35,14
1"	1" NPT	Z641611616	50,80
1"1/4	1"1/4 NPT	Z641612020	91,57
1"1/2	1"1/2 NPT	Z641612424	131,35
2"	2" NPT	Z641613232	262,93

Conexiones Interlock

Interlock series
Embouts Interlock
Serie Interlock

Hembras giratorias JIC 37° doble hexagonal Interlock

Double hexagonal JIC 37° Swivel female

Femelle JIC 37° double hexagonal

Femmina diritta JIC 37° doppio esagono

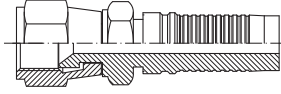

DN	THREAD ROSCA	Part n° Referencia	€
3/4"	1"1/16 12h UN	Z642421712	54,24
1"	1"5/16 12h UN	Z642422116	83,81
1"1/4	1"5/8 12h UN	Z642422620	197,89
1"1/2	1"7/8 12h UN	Z642423024	302,31
2"	2"1/2 12h UN	Z642424032	445,23

Hembras giratorias rectas JIC 37° Interlock

JIC 37° Swivel female Interlock

Femelle tourn.droite JIC 37° Interlock

Femmina gir.diritta JIC 37° Interlock

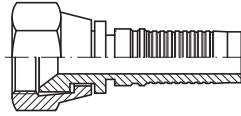

DN	THREAD ROSCA	Part n° Referencia	€
3/4"	1"1/16 12h UN	Z641421712	65,28
1"	1"5/16 12h UN	Z641422116	41,76
1"1/4	1"5/8 12h UN	Z641422620	69,36
1"1/4	1"7/8 12h UN	Z641423020	91,30
1"1/2	1"7/8 12h UN	Z641423024	97,44
2"	2"1/2 12h UN	Z641424032	188,89

Machos JIC 37° Interlock

JIC 37° male Interlock

Mâle JIC 37° Interlock

Maschio JIC 37° Interlock

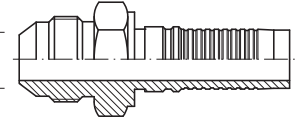

DN	THREAD ROSCA	Part n° Referencia	€
3/4"	1"1/16 12h UN	Z641401712	47,31
1"	1"5/16 12h UN	Z641402116	65,61
1"1/4	1"5/8 12h UN	Z641402620	91,08
1"1/2	1"7/8 12h UN	Z641403024	101,56
2"	2"1/2 12h UN	Z641404032	219,01

Hembras giratorias 90° JIC 37° Interlock

JIC 37° Swivel female Interlock (90° Elbow)

Coude 90° femelle tournante JIC 37° Interlock

Femmina gir. 90° JIC 37° Interlock

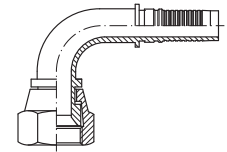

DN	THREAD ROSCA	Part n° Referencia	€
3/4"	1"1/16 12h UN	Z641381712	54,01
1"	1"5/16 12h UN	Z641382116	81,69
1"1/4	1"5/8 12h UN	Z641382620	122,57
1"1/2	1"7/8 12h UN	Z641383024	183,68
2"	2"1/2 12h UN	Z641384032	368,98

Hembras giratorias 45° JIC 37° Interlock

JIC 37° Swivel female Interlock (45° Elbow)

Coude 45° femelle tournante JIC 37° Interlock

Femmina gir. 45° JIC 37° Interlock

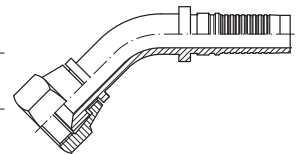

DN	THREAD ROSCA	Part n° Referencia	€
3/4"	1"1/16 12h UN	Z641391712	54,01
1"	1"5/16 12h UN	Z641392116	81,69
1"1/4	1"5/8 12h UN	Z641392620	122,57
1"1/2	1"7/8 12h UN	Z641393024	183,68
2"	2"1/2 12h UN	Z641394032	368,98

Conexiones Interlock

Interlock series
Embouts Interlock
Serie Interlock

Hembras giratorias rectas Métricas cono 24° Interlock con junta tórica

Metric swivel female 24° seat serie S Interlock with o'ring

Femelle droite Métrique 24° Interlock avec o'ring

Femmina Metrica sede 24° con o'ring serie S Interlock

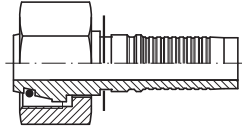

DN	PIPE TUBO	SERIE	THREAD ROSCA	Part nº Referencia	€
3/4"	20	S	M30x2	Z64204302012	45,04
3/4"	25	S	M36x2	Z64204362512	58,43
1"	30	S	M42x2	Z64204423016	66,90
1"1/4	38	S	M52x2	Z64204523820	95,96

Hembras 90° Métricas cono 24° Interlock con junta tórica

Metric swivel female 24° seat serie S Interlock with o'ring (90° Elbow)

Coude 90° femelle Métrique 24° Interlock avec o'ring

Femmina Metrica 90° sede 24° con o'ring serie S Interlock

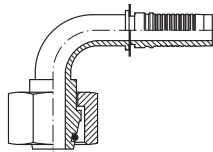

DN	PIPE TUBO	SERIE	THREAD ROSCA	Part nº Referencia	€
3/4"	20	S	M30x2	Z64205302012	64,63
3/4"	25	S	M36x2	Z64205362512	94,76
1"	30	S	M42x2	Z64205423016	119,59
1"1/4	38	S	M52x2	Z64205523820	158,08

Hembras giratorias rectas ORFS Interlock

Interlock ORFS Swivel female straight

Femelle droite ORFS Interlock

Femmina diritta ORFS Interlock

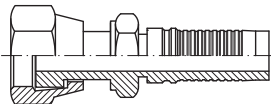

DN	THREAD ROSCA	Part nº Referencia	€
3/4"	1 3/16-12	Z649011912	71,35
1"	1 7/16-12	Z649012316	108,34
1"1/4	1 11/16-12	Z649012720	144,99
1"1/2	2-12	Z649013224	203,09

Machos ORFS Interlock

Interlock ORFS Male

Mâle ORFS Interlock

Maschio ORFS Interlock

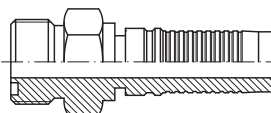

DN	THREAD ROSCA	Part nº Referencia	€
3/4"	1 3/16-12	Z649121912	124,58
1"	1 7/16-12	Z649122316	185,14
1"1/4	1 11/16-12	Z649122720	256,08
1"1/2	2-12	Z649123224	380,67

Hembras 45° Métricas cono 24° Interlock con junta tórica

Metric swivel female 24° seat serie S Interlock with o'ring (45° Elbow)

Coude 45° femelle Métrique 24° Interlock avec o'ring

Femmina Metrica 45° sede 24° serie S Interlock

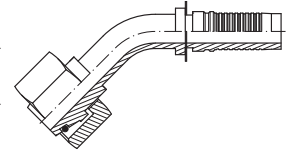

DN	PIPE TUBO	SERIE	THREAD ROSCA	Part nº Referencia	€
3/4"	20	S	M30x2	Z64206302012	64,63
3/4"	25	S	M36x2	Z64206362512	94,76
1"	30	S	M42x2	Z64206423016	119,59
1"1/4	38	S	M52x2	Z64206523820	158,08

Machos Métricos cono 24° Interlock

Metric male stud 24° cone serie S Interlock

Mâle Métrique cone 24° Interlock

Maschio Metrico sede 24° con o'ring serie S Interlock

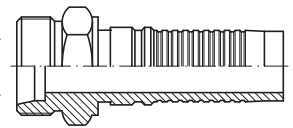

DN	PIPE TUBO	SERIE	THREAD ROSCA	Part nº Referencia	€
3/4"	20	S	M30x2	Z64203302012	47,91
3/4"	25	S	M36x2	Z64203362512	65,93
1"	30	S	M42x2	Z64203423016	75,49
1"1/4	38	S	M52x2	Z64203523820	131,56

Hembras giratorias 90° ORFS Interlock

Interlock ORFS Swivel female (90° Elbow)

Coude 90° femelle ORFS Interlock

Femmina 90° ORFS Interlock

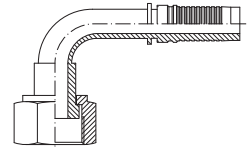

DN	THREAD ROSCA	Part nº Referencia	€
3/4"	1 3/16-12	Z649071912	212,49
1"	1 7/16-12	Z649072316	308,51
1"1/4	1 11/16-12	Z649072720	432,58
1"1/2	2-12	Z649073224	1.247,55

Hembras giratorias 45° ORFS Interlock

Interlock ORFS Swivel female (45° Elbow)

Coude 45° femelle ORFS Interlock

Femmina 45° ORFS Interlock

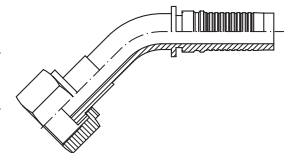

DN	THREAD ROSCA	Part nº Referencia	€
3/4"	1 3/16-12	Z649081912	212,49
1"	1 7/16-12	Z649082316	308,51
1"1/4	1 11/16-12	Z649082720	432,58
1"1/2	2-12	Z649083224	1.247,55

Conexiones Interlock

Interlock series
Embouts Interlock
Serie Interlock

Bridas rectas SAE 3000 PSI Interlock

3000 PSI SAE Straight Flange Interlock / Code 61

Bride SAE droite série 3000 PSI Interlock

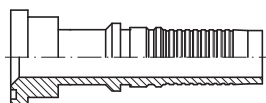

Flangia diritta SAE 3000 Interlock

DN	Ø	Part n° Referencia	€
3/4"	38.1	Z641821212	57,80
3/4"	44.5	Z641821612	68,49
1"	44.5	Z641821616	72,99
1"	50.8	Z641822016	94,70
1"1/4	50.8	Z641822020	119,63
1"1/4	60.3	Z641822420	143,96
1"1/2	60.3	Z641822424	155,91
1"1/2	71.4	Z641823224	239,77
2"	71.4	Z641823232	243,51

Bridas 90° SAE 3000 PSI Interlock

3000 PSI SAE Flange Interlock (90° Elbow) / Code 61

Coude 90° bride SAE série 3000 PSI Interlock

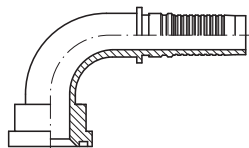

Flangia 90° SAE 3000 Interlock

DN	Ø	Part n° Referencia	€
3/4"	38.1	Z641831212	83,88
3/4"	44.5	Z641831612	123,85
1"	44.5	Z641831616	125,78
1"	50.8	Z641832016	190,27
1"1/4	50.8	Z641832020	160,35
1"1/4	60.3	Z641832420	263,65
1" 1/2	60.3	Z641832424	272,32
1" 1/2	71.4	Z641833224	406,24
2"	71.4	Z641833232	382,19

Bridas 45° SAE 3000 PSI Interlock

3000 PSI SAE Flange Interlock (45° Elbow) / Code 61

Coude 45° bride SAE série 3000 PSI Interlock

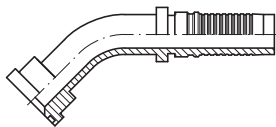

Flangia 45° SAE 3000 Interlock

DN	Ø	Part n° Referencia	€
3/4"	38.1	Z641841212	83,88
3/4"	44.5	Z641841612	123,85
1"	44.5	Z641841616	125,78
1"	50.8	Z641842016	190,27
1"1/4	50.8	Z641842020	160,35
1"1/4	60.3	Z641842420	263,65
1" 1/2	60.3	Z641842424	272,32
2"	71.4	Z641843224	406,24
2"	71.4	Z641843232	382,19

Bridas Rectas SAE 6000 PSI Interlock

6000 PSI SAE Straight Flange Interlock / Code 62

Bride SAE droite série 6000 PSI Interlock

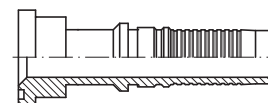

Flangia diritta SAE 6000 Interlock

DN	Ø	Part n° Referencia	€
3/4"	41.3	Z642821212	66,44
3/4"	47.6	Z642821612	79,23
1"	47.6	Z642821616	79,81
1"	54	Z642822016	122,48
1"1/4	54	Z642822020	121,42
1"1/4	63.5	Z642822420	161,78
1"1/2	63.5	Z642822424	158,24
1"1/2	79.4	Z642823224	281,43
2"	79.4	Z642823232	255,57

Bridas 90° SAE 6000 PSI Interlock

6000 PSI SAE Flange Interlock (90° Elbow) / Code 62

Coude 90° bride SAE série 6000 PSI Interlock

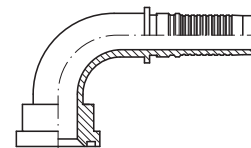

Flangia 90° SAE 6000 Interlock

DN	Ø	Part n° Referencia	€
3/4"	41.3	Z642831212	89,90
3/4"	47.6	Z642831612	125,69
1"	47.6	Z642831616	127,23
1"	54	Z642832016	193,12
1"1/4	54	Z642832020	163,80
1"1/4	63.5	Z642832420	267,20
1"1/2	63.5	Z642832424	276,40
1"1/2	79.4	Z642833224	419,99
2"	79.4	Z642833232	389,31

Bridas 45° SAE 6000 PSI Interlock

6000 PSI SAE Flange Interlock (45° Elbow) / Code 62

Coude 45° bride SAE série 6000 PSI Interlock

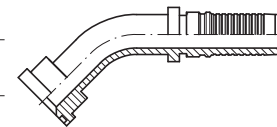

Flangia 45° SAE 6000 Interlock

DN	Ø	Part n° Referencia	€
3/4"	41.3	Z642841212	89,90
3/4"	47.6	Z642841612	125,69
1"	47.6	Z642841616	127,23
1"	54	Z642842016	193,12
1"1/4	54	Z642842020	163,80
1"1/4	63.5	Z642842420	267,20
1"1/2	63.5	Z642842424	276,40
1"1/2	79.4	Z642843224	419,99
2"	79.4	Z642843232	389,31

Conexiones Compactas Serie 43 R1AT/R2AT/1SN/2SN/R16/2SC

One piece fittings 43 Series R1AT/R2AT/1SN/2SN/R16/2SC
 Embouts pré-sertis R1AT/R2AT/1SN/2SN/R16/2SC Série 43
 Raccordi compatti R1AT/R2AT/1SN/2SN/R16/2SC Serie 43

Hembras giratorias rectas compactas JIC 37°

One piece JIC 37° Swivel female

Femelle pré-sertie JIC 37°

Femmina diritta compatta JIC 37°

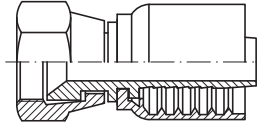

DN	THREAD ROSCA	Part n° Referencia	€
1/4"	7/16" 20h UNF	881420704	20,20
3/8"	9/16" 18h UNF	881420906	24,73
1/2"	3/4" 16h UNF	881421208	30,31
5/8"	7/8" 14h UNF	881421410	37,29
3/4"	1"1/16 12h UN	881421712	49,08
1"	1"5/16 12h UN	881422116	74,16
1"1/4"	1"5/8 12h UN	881422620	113,27
1"1/2"	1"7/8 12h UN	881423024	177,32
2"	2"1/2 12h UN	881424032	300,39

Hembras giratorias 90° compactas JIC 37°

One piece JIC 37° Swivel female (90° Elbow)

Coude 90° femelle pré-sertie JIC 37°

Femmina 90° compatta JIC 37°

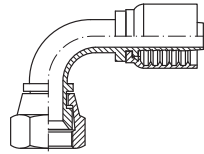

DN	THREAD ROSCA	Part n° Referencia	€
1/4"	7/16" 20h UNF	881380704	31,30
3/8"	9/16" 18h UNF	881380906	35,85
1/2"	3/4" 16h UNF	881381208	39,60
1/2"	7/8" 14h UNF	881381408	44,70
5/8"	7/8" 14h UNF	881381410	53,02
3/4"	1"1/16 12h UN	881381712	70,09
1"	1"5/16 12h UN	881382116	106,27
1"1/4"	1"5/8 12h UN	881382620	177,58
1"1/2"	1"7/8 12h UN	881383024	259,26
2"	2"1/2 12h UN	881384032	541,74

Hembras giratorias 45° compactas JIC 37°

One piece JIC 37° Swivel female (45° Elbow)

Coude 45° femelle pré-sertie JIC 37°

Femmina 45° compatta JIC 37°

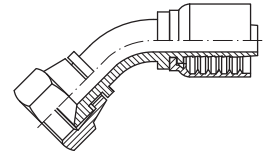

DN	THREAD ROSCA	Part n° Referencia	€
1/4"	7/16" 20h UNF	881390704	31,30
3/8"	9/16" 18h UNF	881390906	35,85
1/2"	3/4" 16h UNF	881391208	39,60
3/4"	1"1/16 12h UN	881391712	70,09
1"	1"5/16 12h UN	881392116	106,27
1"1/4"	1"5/8 12h UN	881392620	177,58
1"1/2"	1"7/8 12h UN	881393024	259,26
2"	2"1/2 12h UN	881394032	541,74

Machos compactos rosca JIC 37°

One piece JIC 37° male

Mâle pré-serti JIC 37°

Maschio compatto JIC sede 37°

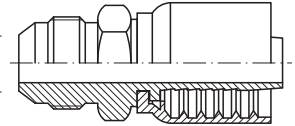

DN	THREAD ROSCA	Part n° Referencia	€
1/4"	7/16" 20h UNF	881400704	23,63
3/8"	9/16" 18h UNF	881400906	28,07
1/2"	3/4" 16h UNF	881401208	32,54
3/4"	1"1/16 12h UN	881401712	48,81
1"	1"5/16 12h UN	881402116	79,14
1"1/4"	1"5/8 12h UN	881402620	125,71
1"1/2"	1"7/8 12h UN	881403024	156,05
2"	2"1/2 12h UN	881404032	275,15

Hembras giratorias rectas compactas JIC 37° doble hexagonal

One piece double hexagonal JIC 37° Swivel female

Femelle pré-sertie JIC 37° double hexagonal

Femmina diritta JIC 37° doppio esagono

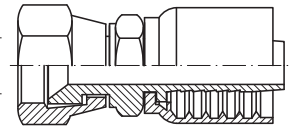

DN	THREAD ROSCA	Part n° Referencia	€
1/4"	7/16" 20h UNF	882420704	24,05
3/8"	9/16" 18h UNF	882420906	28,74
1/2"	3/4" 16h UNF	882421208	33,97
1/2"	7/8" 14h UNF	882421408	44,74
3/4"	1"1/16 12h UN	882421712	56,26
3/4"	1"5/16 12h UN	882422112	75,48
1"	1"5/16 12h UN	882422116	85,54
1"1/4"	1"5/8 12h UN	882422620	141,60
1"1/2"	1"7/8 12h UN	882423024	222,98
2"	2"1/2 12h UN	882424032	353,16

Conexiones Compactas Serie 43 R1AT/R2AT/1SN/2SN/R16/2SC

One piece fittings 43 Series R1AT/R2AT/1SN/2SN/R16/2SC
 Embouts pré-sertis R1AT/R2AT/1SN/2SN/R16/2SC Série 43
 Raccordi compatti R1AT/R2AT/1SN/2SN/R16/2SC Serie 43

Hembras giratorias rectas compactas ORFS doble hexagonal

One piece double hexagonal ORFS Swivel female

Femelle pré-sertie ORFS double hexagonal

Femmina diritta compatta ORFS doppio esagono

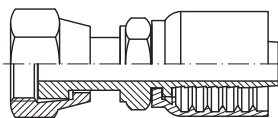

DN	THREAD ROSCA	Part n° Referencia	€
1/4"	9/16" 18h	889000904	38,50
3/8"	11/16" 16h	889001106	46,52
1/2"	13/16" 16h	889001308	52,82
5/8"	1" 14h	889001610	72,81
3/4"	1"3/16 12h	889001912	83,17
1"	1"7/16 12h	889002316	117,33
1"1/4	1"11/16 12h	889002720	207,61
1"1/2	2" 12h	889003224	263,15

Hembras giratorias 90° compactas ORFS

One piece ORFS Swivel female (90° Elbow)

Coude 90° femelle pré-sertie ORFS

Femmina 90° compatta ORFS

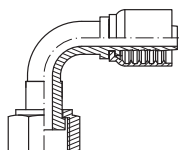

DN	THREAD ROSCA	Part n° Referencia	€
1/4"	9/16" 18h	889070904	66,86
3/8"	11/16" 16h	889071106	81,21
1/2"	13/16" 16h	889071308	87,82
5/8"	1" 14h	889071610	118,00
3/4"	1"3/16 12h	889071912	151,86
1"	1"7/16 12h	889072316	221,03
1"1/4	1"11/16 12h	889072720	316,59
1"1/2	2" 12h	889073224	826,70

Hembras giratorias 45° compactas ORFS

One piece ORFS Swivel female (45° Elbow)

Coude 45° femelle pré-sertie ORFS

Femmina 45° compatta ORFS

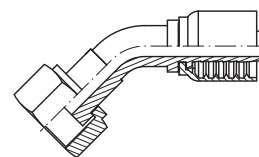

DN	THREAD ROSCA	Part n° Referencia	€
1/4"	9/16" 18h	889080904	66,86
3/8"	11/16" 16h	889081106	81,21
1/2"	13/16" 16h	889081308	87,82
5/8"	1" 14h	889081610	118,00
3/4"	1"3/16 12h	889081912	151,86
1"	1"7/16 12h	889082316	221,03
1"1/4	1"11/16 12h	889082720	316,59
1"1/2	2" 12h	889083224	826,70

Machos compactos ORFS

One piece ORFS male

Mâle pré-serti ORFS

Maschio compatto ORFS

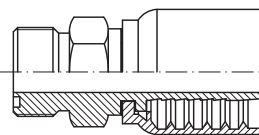

DN	THREAD ROSCA	Part n° Referencia	€
1/4"	9/16" 18h	889120904	38,57
3/8"	11/16" 16h	889121106	44,31
1/2"	13/16" 16h	889121308	51,61
5/8"	1" 14h	889121610	78,09
3/4"	1"3/16 12h	889121912	98,04
1"	1"7/16 12h	889122316	145,43
1"1/4	1"11/16 12h	889122720	207,93
1"1/2	2" 12h	889123224	300,84

Conexiones Compactas Serie 43 R1AT/R2AT/1SN/2SN/R16/2SC

One piece fittings 43 Series R1AT/R2AT/1SN/2SN/R16/2SC
 Embouts pré-sertis R1AT/R2AT/1SN/2SN/R16/2SC Série 43
 Raccordi compatti R1AT/R2AT/1SN/2SN/R16/2SC Serie 43

Hembras giratorias rectas compactas rosca NPSM cono 60°

One piece NPSM Swivel female 60° cone

Femelle pré-sertie NPSM cone 60°

Femmina diritta compatta NPSM sede 60°

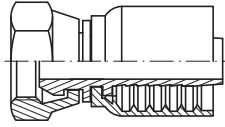

DN	THREAD ROSCA	Part n° Referencia	€
1/4"	1/4" 18h NPSM	882610404	21,64
3/8"	3/8" 18h NPSM	882610606	24,97
1/2"	1/2" 14h NPSM	882610808	30,85
3/4"	3/4" 14h NPSM	882611212	51,48
1"	1" - 11 1/2 h NPSM	882611616	77,91

Hembras giratorias 90° compactas rosca NPSM cono 60°

One piece NPSM Swivel female 60° cone (90° Elbow)

Coude 90° femelle pré-sertie NPSM cone 60°

Femmina 90° compatta NPSM sede 60°

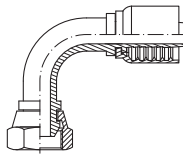

DN	THREAD ROSCA	Part n° Referencia	€
1/4"	1/4" 18h NPSM	882620404	31,43
3/8"	3/8" 18h NPSM	882620606	36,54
1/2"	1/2" 14h NPSM	882620808	43,18
3/4"	3/4" 14h NPSM	882621212	77,02
1"	1" - 11 1/2 h NPSM	882621616	109,68

Hembras giratorias 45° compactas rosca NPSM cono 60°

One piece NPSM Swivel female 60° cone (45° Elbow)

Coude 45° femelle pré-sertie NPSM cone 60°

Femmina 45° compatta NPSM sede 60°

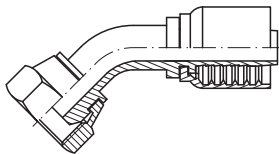

DN	THREAD ROSCA	Part n° Referencia	€
1/4"	1/4" 18h NPSM	882630404	31,43
3/8"	3/8" 18h NPSM	882630606	36,54
1/2"	1/2" 14h NPSM	882630808	43,18
3/4"	3/4" 14h NPSM	882631212	77,02
1"	1" - 11 1/2 h NPSM	882631616	109,68

Machos compactos rosca cónica NPT

One piece NPT male pipe straight

Mâle pré-serti NPT

Maschio compatto conico NPT

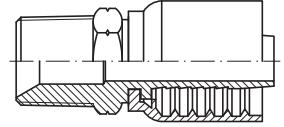

DN	THREAD ROSCA	Part n° Referencia	€
1/4"	1/4" NPT	881610404	19,01
1/4"	3/8" NPT	881610604	23,05
3/8"	3/8" NPT	881610606	23,76
1/2"	1/2" NPT	881610808	29,95
3/4"	3/4" NPT	881611212	47,22
1"	1" NPT	881611616	73,13
1"1/4"	1"1/4 NPT	881612020	120,03
1"1/2"	1"1/2 NPT	881612424	159,85
2"	2" NPT	881613232	231,49

Hembras giratorias rectas compactas rosca NPSM cono 60° doble hexagonal

One piece double hexagonal NPSM Swivel female 60° cone

Femelle pré-sertie NPSM cone 60° double hexagonal

Femmina diritta compatta NPSM sede 60° doppio esagono

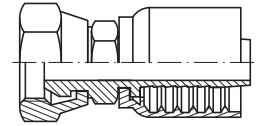

DN	THREAD ROSCA	Part n° Referencia	€
1/4"	1/4" 18h NPSM	883610404	28,21
3/8"	3/8" 18h NPSM	883610606	33,35
1/2"	1/2" 14h NPSM	883610808	43,55
3/4"	3/4" 14h NPSM	883611212	67,15
1"	1" - 11 1/2 h NPSM	883611616	104,12

Conexiones Compactas Serie 43 R1AT/R2AT/1SN/2SN/R16/2SC

One piece fittings 43 Series R1AT/R2AT/1SN/2SN/R16/2SC
 Embouts pré-sertis R1AT/R2AT/1SN/2SN/R16/2SC Série 43
 Raccordi compatti R1AT/R2AT/1SN/2SN/R16/2SC Serie 43

Bridas rectas compactas SAE 3000 PSI

One piece 3000 PSI SAE Straight Flange / Code 61

Bride SAE droite pré-sertie série 3000 PSI

Flangia diritta compatta SAE 3000 PSI

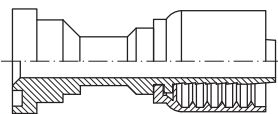

DN	Ø	Part n° Referencia	€
1/2"	30.2	881820808	53,68
3/4"	38.1	881821212	75,75
1"	44.5	881821616	100,33
1"1/4	50.8	881822020	157,40
1"1/2	60.3	881822424	203,59
2"	71.4	881823232	310,29

Bridas rectas compactas SAE 6000 PSI

One piece 6000 PSI SAE Straight Flange / Code 62

Bride SAE droite pré-sertie série 6000 PSI

Flangia diritta compatta SAE 6000 PSI

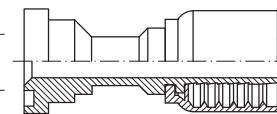

DN	Ø	Part n° Referencia	€
1/2"	31.8	882820808	60,73
3/4"	41.3	882821212	87,89
1"	47.6	882821616	110,63
1"1/4	54	882822020	167,92
1"1/2	63.5	882822424	209,49
2"	79.4	882823232	332,52

Bridas 90° compactas SAE 3000 PSI

One piece 3000 PSI SAE Flange (90° Elbow) / Code 61

Bride SAE coude 90° pré-sertie série 3000 PSI

Flangia 90° compatta SAE 3000 PSI

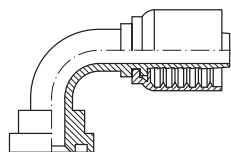

DN	Ø	Part n° Referencia	€
1/2"	30.2	881830808	73,12
3/4"	38.1	881831212	105,23
1"	44.5	881831616	157,33
1"1/4	50.8	881832020	211,85
1"1/2	60.3	881832424	310,13
2"	71.4	881833232	446,59

Bridas 90° compactas SAE 6000 PSI

One piece 6000 PSI SAE Flange (90° Elbow) / Code 62

Bride SAE coude 90° pré-sertie série 6000 PSI

Flangia 90° compatta SAE 6000 PSI

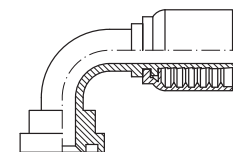

DN	Ø	Part n° Referencia	€
1/2"	31.8	882830808	73,33
3/4"	41.3	882831212	110,20
1"	47.6	882831616	157,61
1"1/4	54	882832020	214,48
1"1/2	63.5	882832424	319,54
2"	79.4	882833232	465,92

Bridas 45° compactas SAE 3000 PSI

One piece 3000 PSI SAE Flange (45° Elbow) / Code 61

Bride SAE coude 45° pré-sertie série 3000 PSI

Flangia 45° compatta SAE 3000 PSI

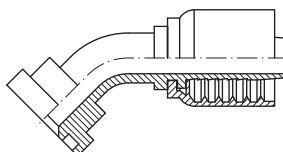

DN	Ø	Part n° Referencia	€
1/2"	30.2	881840808	73,12
3/4"	38.1	881841212	105,23
1"	44.5	881841616	157,33
1"1/4	50.8	881842020	211,85
1"1/2	60.3	881842424	313,13
2"	71.4	881843232	446,59

Bridas 45° compactas SAE 6000 PSI

One piece 6000 PSI SAE Flange (45° Elbow) / Code 62

Bride SAE coude 45° pré-sertie série 6000 PSI

Flangia 45° compatta SAE 6000 PSI

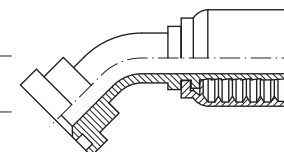

DN	Ø	Part n° Referencia	€
1/2"	31.8	882840808	73,33
3/4"	41.3	882841212	110,20
1"	47.6	882841616	157,61
1"1/4	54	882842020	214,48
1"1/2	63.5	882842424	319,54
2"	79.4	882843232	465,92

Conexiones Compactas Serie 43 R1AT/R2AT/1SN/2SN/R16/2SC

One piece fittings 43 Series R1AT/R2AT/1SN/2SN/R16/2SC
Embouts pré-sertis R1AT/R2AT/1SN/2SN/R16/2SC Série 43
Raccordi compatti R1AT/R2AT/1SN/2SN/R16/2SC Serie 43

Hembras giratorias rectas compactas rosca Métrica cono 24° - DKO

One piece Metric female cone 24°

Femelle pré-sertie Métrique cono 24°

Femmina diritta compatta Metrica sede 24°

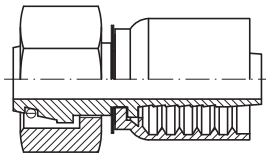

DN	PIPE TUBO	SERIE	THREAD ROSCA	Part n° Referencia	€
1/4"	6	L	M12x1.5	88804120604	19,97
1/4"	8	L	M14x1.5	88804140804	18,88
1/4"	10	L	M16x1.5	88804161004	22,66
5/16"	10	L	M16x1.5	88804161005	26,44
3/8"	12	L	M18x1.5	88804181206	23,29
1/2"	15	L	M22x1.5	88804221508	28,72
1/2"	18	L	M26x1.5	88804261808	39,57
5/8"	18	L	M26x1.5	88804261810	39,16
3/4"	22	L	M30x2	88804302212	52,63
1"	28	L	M36x2	88804362816	77,07
1"1/4	35	L	M45x2	88804453520	127,68
1"1/2	42	L	M52x2	88804524224	166,62
1/4"	8	S	M16x1.5	88804160804	22,11
3/8"	10	L	M16x1.5	88804161006	24,99
1/4"	10	S	M18x1.5	88804181004	21,88
3/8"	12	S	M20x1.5	88804201206	28,80
1/2"	16	S	M24x1.5	88804241608	31,28
5/8"	20	S	M30x2	88804302010	42,83
3/4"	20	S	M30x2	88804302012	63,70
3/4"	25	S	M36x2	88804362512	67,52
1"	25	S	M36x2	88804362516	90,90
1"	30	S	M42x2	88804423016	89,46
1"1/4	38	S	M52x2	88804523820	144,84

Hembras giratorias 45° compactas Métricas cono 24° - DKO 45°

One piece Metric female cone 24° (45° Elbow)

Coûde 45° femelle pré-sertie Métrique cono 24°

Femmina 45° compatta Metrica sede 24°

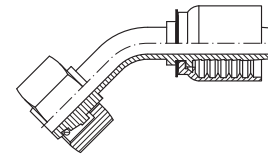

DN	PIPE TUBO	SERIE	THREAD ROSCA	Part n° Referencia	€
1/4"	6	L	M12x1.5	88306120604	32,05
1/4"	8	L	M14x1.5	88306140804	30,93
1/4"	10	L	M16x1.5	88306161004	33,32
5/16"	10	L	M16x1.5	88306161005	40,00
3/8"	10	L	M16x1.5	88306161006	38,62
3/8"	12	L	M18x1.5	88306181206	36,60
1/2"	15	L	M22x1.5	88306221508	40,87
5/8"	18	L	M26x1.5	88306261810	62,13
3/4"	22	L	M30x2	88306302212	76,31
1"	28	L	M36x2	88306362816	112,32
1"1/4	35	L	M45x2	88306453520	182,79
1"1/2	42	L	M52x2	88306524224	260,18
1/4"	8	S	M16x1.5	88306160804	33,96
1/4"	10	S	M18x1.5	88306181004	33,85
3/8"	12	S	M20x1.5	88306201206	38,39
1/2"	16	S	M24x1.5	88306241608	43,76
5/8"	20	S	M30x2	88306302010	69,54
3/4"	20	S	M30x2	88306302012	74,41
3/4"	25	S	M36x2	88306362512	98,86
1"	25	S	M36x2	88306362516	121,41
1"	30	S	M42x2	88306423016	140,22
1"1/4	38	S	M52x2	88306523820	230,10

Hembras giratorias 90° compactas Métricas cono 24° - DKO 90°

One piece Metric female cone 24° (90° Elbow)

Coûde 90° femelle pré-sertie Métrique cono 24°

Femmina 90° compatta Metrica sede 24°

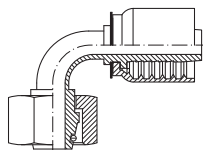

DN	PIPE TUBO	SERIE	THREAD ROSCA	Part n° Referencia	€
1/4"	6	L	M12x1.5	88305120604	32,05
1/4"	8	L	M14x1.5	88305140804	30,93
1/4"	10	L	M16x1.5	88305161004	33,32
5/16"	10	L	M16x1.5	88305161005	40,00
3/8"	12	L	M18x1.5	88305181206	36,60
1/2"	15	L	M22x1.5	88305221508	40,87
5/8"	18	L	M26x1.5	88305261810	62,13
3/4"	22	L	M30x2	88305302212	76,31
1"	28	L	M36x2	88305362816	112,32
1"1/4	35	L	M45x2	88305453520	182,79
1"1/2	42	L	M52x2	88305524224	260,18
1/4"	8	S	M16x1.5	88305160804	33,96
1/4"	10	S	M18x1.5	88305181004	33,85
5/16"	12	S	M20x1.5	88305201205	42,32
3/8"	12	S	M20x1.5	88305201206	38,39
1/2"	16	S	M24x1.5	88305241608	43,76
5/8"	20	S	M30x2	88305302010	69,54
3/4"	20	S	M30x2	88305302012	74,41
3/4"	25	S	M36x2	88305362512	98,86
1"	25	S	M36x2	88305362516	121,41
1"	30	S	M42x2	88305423016	140,22
1"1/4	38	S	M52x2	88305523820	230,10

Machos compactos rosca Métrica cono 24°

One piece Metric male cone 24°

Mâle pré-serti Métrique cono 24°

Maschio compatto Metrico sede 24°

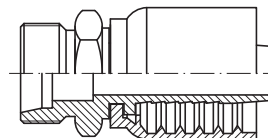

DN	PIPE TUBO	SERIE	THREAD ROSCA	Part n° Referencia	€
1/4"	6	L	M12x1.5	88203120604	22,76
1/4"	8	L	M14x1.5	88203140804	22,33
5/16"	10	L	M16x1.5	88203161005	26,84
3/8"	10	L	M16x1.5	88203161006	28,20
3/8"	12	L	M18x1.5	88203181206	24,71
1/2"	15	L	M22x1.5	88203221508	30,24
5/8"	18	L	M26x1.5	88203261810	36,71
3/4"	22	L	M30x2	88203302212	51,37
1"	28	L	M36x2	88203362816	72,40
1"1/4	35	L	M45x2	88203453520	122,10
1"1/2	42	L	M52x2	88203524224	173,13
1/4"	8	S	M16x1.5	88203160804	25,19
1/4"	10	S	M18x1.5	88203181004	28,43
3/8"	12	S	M20x1.5	88203201206	30,60
1/2"	16	S	M24x1.5	88203241608	35,21
5/8"	20	S	M30x2	88203302010	42,73
3/4"	20	S	M30x2	88203302012	52,71
3/4"	25	S	M36x2	88203362512	61,56
1"	25	S	M36x2	88203362516	81,03
1"	30	S	M42x2	88203423016	95,41
1"1/4	38	S	M52x2	88203523820	151,14

Conexiones Compactas Serie 43 R1AT/R2AT/1SN/2SN/R16/2SC

One piece fittings 43 Series R1AT/R2AT/1SN/2SN/R16/2SC
 Embouts pré-sertis R1AT/R2AT/1SN/2SN/R16/2SC Série 43
 Raccordi compatti R1AT/R2AT/1SN/2SN/R16/2SC Serie 43

Hembras giratorias rectas compactas rosca BSP cono 60°

One piece BSP female 60° cone

Femelle pré-sertie BSP cono 60°

Femmina diritta compatta BSP sede 60°

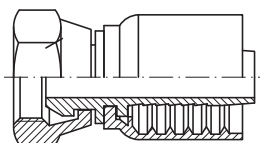

DN	THREAD ROSCA	Part nº Referencia	€
1/4"	1/4" BSP	881000404	18,70
3/8"	3/8" BSP	881000606	23,13
3/8"	1/2" BSP	881000806	29,33
1/2"	1/2" BSP	881000808	27,92
5/8"	1/2" BSP	881000810	40,53
5/8"	5/8" BSP	881001010	41,64
3/4"	3/4" BSP	881001212	47,06
1"	1" BSP	881001616	71,72
1"1/4"	1"1/4 BSP	881002020	113,62
1"1/2"	1"1/2 BSP	881002424	158,63
2"	2" BSP	881003232	229,51

Hembras giratorias rectas compactas rosca BSP cono 60° doble hexagonal

One piece double hexagonal BSP female 60° cone

Femelle pré-sertie BSP cono 60° double hexagonal

Femmina diritta compatta BSP sede 60° doppio esagono

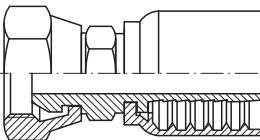

DN	THREAD ROSCA	Part nº Referencia	€
1/4"	1/4" BSP	884000404	26,48
3/8"	3/8" BSP	884000605	30,59
3/8"	3/8" BSP	884000606	30,70
1/2"	1/2" BSP	884000808	36,62
3/4"	3/4" BSP	884001212	62,48
1"	1" BSP	884001616	96,68
1"1/4"	1"1/4 BSP	884002020	138,18
1"1/2"	1"1/2 BSP	884002424	203,59
2"	2" BSP	884003232	319,64

Machos compactos rosca cilíndrica BSP cono 60°

One piece BSP male 60° cone

Mâle pré-serti BSP cono 60°

Maschio compatto cilindrico BSP sede 60°

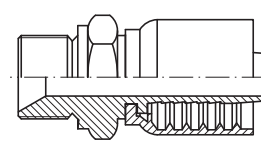

DN	THREAD ROSCA	Part nº Referencia	€
1/4"	1/4" BSP	881120404	19,14
3/8"	3/8" BSP	881120606	23,65
3/8"	1/2" BSP	881120806	29,21
1/2"	1/2" BSP	881120808	30,32
3/4"	3/4" BSP	881121212	47,81
1"	1" BSP	881121616	75,46
1"1/4"	1"1/4 BSP	881122020	131,04
1"1/2"	1"1/2 BSP	881122424	163,34
2"	2" BSP	881123232	240,91

Hembras giratorias 90° compactas rosca BSP cono 60°

One piece BSP female cone 60° (90° Elbow)

Coude 90° femelle pré-sertie BSP cono 60°

Femmina 90° compatta BSP sede 60°

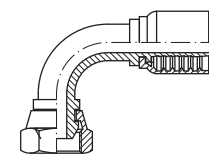

DN	THREAD ROSCA	Part nº Referencia	€
1/4"	1/4" BSP	881070404	27,63
3/8"	3/8" BSP	881070606	32,28
1/2"	1/2" BSP	881070808	40,26
3/4"	3/4" BSP	881071212	67,95
1"	1" BSP	881071616	100,74
1"1/4"	1"1/4 BSP	881072020	172,44
1"1/2"	1"1/2 BSP	881072424	222,52
2"	2" BSP	881073232	360,74

Hembras giratorias 45° compactas rosca BSP cono 60°

One piece BSP female cone 60° (45° Elbow)

Coude 45° femelle pré-sertie BSP cono 60°

Femmina 45° compatta BSP sede 60°

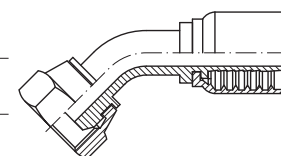

DN	THREAD ROSCA	Part nº Referencia	€
1/4"	1/4" BSP	881080404	27,63
3/8"	3/8" BSP	881080606	32,28
1/2"	1/2" BSP	881080808	40,26
3/4"	3/4" BSP	881081212	67,95
1"	1" BSP	881081616	100,74
1"1/4"	1"1/4 BSP	881082020	172,44
1"1/2"	1"1/2 BSP	881082424	222,52
2"	2" BSP	881083232	360,74

Conexiones Compactas R7/R8 y Elastómero malla metálica

One piece fittings R7/R8 & Elastomer Braid of steel wire
Emboutis pré-sertis R7/R8 et Elastomère tresse métallique
Raccordi compatti serie R7/R8 e elastomero treccia metallica

Hembras giratorias rectas compactas rosca JIC 37°

One piece JIC 37° female

Femelle pré-sertie JIC 37°

Femmina diritta compatta JIC 37°

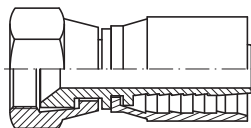

DN	THREAD ROSCA	Part n° Referencia	€
3/16"	7/16" 20h UNF	871420703	22,68
1/4"	7/16" 20h UNF	871420704	19,25
1/4"	9/16" 18h UNF	871420904	22,19
3/8"	9/16" 18h UNF	871420906	22,38
1/2"	3/4" 16h UNF	871421208	27,35
3/4"	1"1/16 12h UN	871421712	42,36
1"	1"5/16 12h UN	871422116	66,45

Hembras giratorias 90° compactas rosca JIC 37°

One piece JIC 37° female (90° Elbow)

90° Femelle pré-sertie JIC 37°

Femmina 90° compatta JIC 37°

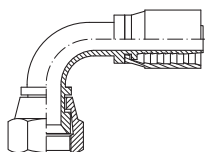

DN	THREAD ROSCA	Part n° Referencia	€
3/16"	7/16" 20h UNF	871380703	34,94
1/4"	7/16" 20h UNF	871380704	30,35
3/8"	9/16" 18h UNF	871380906	33,50
1/2"	3/4" 16h UNF	871381208	36,64
3/4"	1"1/16 12h UN	871381712	63,37
1"	1"5/16 12h UN	871382116	98,56

Hembras giratorias 45° compactas rosca JIC 37°

One piece JIC 37° female (45° Elbow)

45° Femelle pré-sertie JIC 37°

Femmina 45° compatta JIC 37°

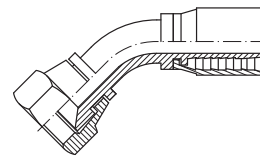

DN	THREAD ROSCA	Part n° Referencia	€
1/4"	7/16" 20h UNF	871390704	30,35
3/8"	9/16" 18h UNF	871390906	33,50
1/2"	3/4" 16h UNF	871391208	36,64
3/4"	1"1/16 12h UN	871391712	63,37
1"	1"5/16 12h UN	871392116	98,56

Machos compactos rosca JIC 37°

One piece JIC 37° male

Mâle pré-serti JIC 37°

Maschio compatto JIC sede 37°

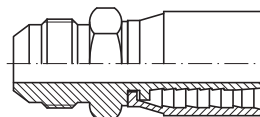

DN	THREAD ROSCA	Part n° Referencia	€
1/4"	7/16" 20h UNF	871400704	22,68
3/8"	9/16" 18h UNF	871400906	25,72
1/2"	3/4" 16h UNF	871401208	29,58
3/4"	1"1/16 12h UN	871401712	42,09
1"	1"5/16 12h UN	871402116	71,43

Hembras giratorias rectas compactas rosca JIC 37° doble hexagonal

One piece double hexagonal JIC 37° female

Femelle pré-sertie JIC 37° double hexagonal

Femmina diritta JIC 37° doppio esagono

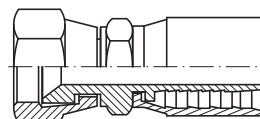

DN	THREAD ROSCA	Part n° Referencia	€
1/4"	7/16" 20h UNF	872420704	23,10
3/8"	9/16" 18h UNF	872420906	26,39
1/2"	3/4" 16h UNF	872421208	31,01
3/4"	1"1/16 12h UN	872421712	49,54
1"	1"5/16 12h UN	872422116	77,83

Conexiones Compactas R7/R8 y Elastómero malla metálica

One piece fittings R7/R8 & Elastomer Braid of steel wire
 Embouts pré-sertis R7/R8 et Elastomère tresse métallique
 Raccordi compatti serie R7/R8 e elastomero treccia metallica

Hembras giratorias rectas compactas rosca ORFS doble hexagonal

One piece double hexagonal ORFS female

Femelle pré-sertie ORFS double hexagonal

Femmina diritta compatta ORFS

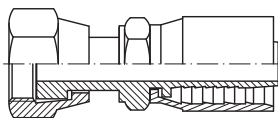

DN	THREAD ROSCA	Part n° Referencia	€
1/4"	9/16	879000904	37,55
3/8"	11/16	879001106	44,17
1/2"	13/16	879001308	49,86
3/4"	1 3/16	879001912	76,45
1"	1 7/16	879002316	109,62

Hembras giratorias 90° compactas rosca ORFS

One piece ORFS female (90° Elbow)

90° Femelle pré-sertie ORFS

Femmina 90° compatta ORFS

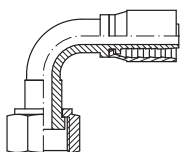

DN	THREAD ROSCA	Part n° Referencia	€
1/4"	9/16	879070904	65,91
3/8"	11/16	879071106	78,86
1/2"	13/16	879071308	84,86
3/4"	1 3/16	879071912	145,14
1"	1 7/16	879072316	213,32

Hembras giratorias 45° compactas rosca ORFS

One piece ORFS female (45° Elbow)

45° Femelle pré-sertie ORFS

Femmina 45° compatta ORFS

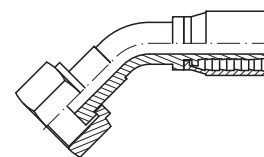

DN	THREAD ROSCA	Part n° Referencia	€
1/4"	9/16	879080904	65,91
3/8"	11/16	879081106	78,86
1/2"	13/16	879081308	84,86
3/4"	1 3/16	879081912	145,14
1"	1 7/16	879082316	213,32

Machos compactos rosca ORFS

One piece ORFS male

Mâle pré-serti ORFS

Maschio compatto ORFS

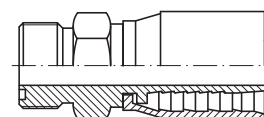

DN	THREAD ROSCA	Part n° Referencia	€
1/4"	9/16	879120904	37,62
3/8"	11/16	879121106	41,96
1/2"	13/16	879121308	48,65
3/4"	1 3/16	879121912	91,32
1"	1 7/16	879122316	137,72

Conexiones Compactas R7/R8 y Elastómero malla metálica

One piece fittings R7/R8 & Elastomer Braid of steel wire
 Embouts pré-sertis R7/R8 et Elastomère tresse métallique
 Raccordi compatti serie R7/R8 e elastomero treccia metallica

Hembras giratorias rectas compactas rosca NPSM cono 60°

One piece NPSM female 60° cone

Femelle pré-sertie NPSM cono 60°

Femmina diritta compatta NPSM sede 60°

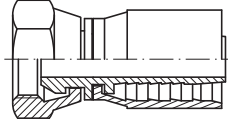

DN	THREAD ROSCA	Part n° Referencia	€
1/4"	1/4" 18h NPSM	872610404	20,69
3/8"	3/8" 18h NPSM	872610606	22,62
1/2"	1/2" 14h NPSM	872610808	27,89
3/4"	3/4" 14h NPSM	872611212	44,76
1"	1" - 11 1/2 h NPSM	872611616	70,20

Hembras giratorias 90° compactas rosca NPSM cono 60°

One piece NPSM female 60° cone (90° Elbow)

90° Femelle pré-sertie NPSM cono 60°

Femmina 90° compatta NPSM sede 60°

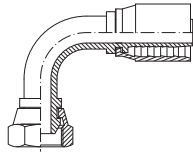

DN	THREAD ROSCA	Part n° Referencia	€
1/4"	1/4" 18h NPSM	872620404	30,48
3/8"	3/8" 18h NPSM	872620606	34,19
1/2"	1/2" 14h NPSM	872620808	40,22
3/4"	3/4" 14h NPSM	872621212	70,30
1"	1" - 11 1/2 h NPSM	872621616	101,97

Hembras giratorias 45° compactas rosca NPSM cono 60°

One piece NPSM female 60° cone (45° Elbow)

45° Femelle pré-sertie NPSM cono 60°

Femmina 45° compatta NPSM sede 60°

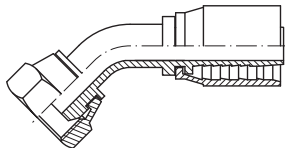

DN	THREAD ROSCA	Part n° Referencia	€
1/4"	1/4" 18h NPSM	872630404	30,48
3/8"	3/8" 18h NPSM	872630606	34,19
1/2"	1/2" 14h NPSM	872630808	40,22
3/4"	3/4" 14h NPSM	872631212	70,30
1"	1" - 11 1/2 h NPSM	872631616	101,97

Machos compactos rosca cónica NPT

One piece NPT male pipe straight

Mâle pré-serti NPT

Maschio compatto conico NPT

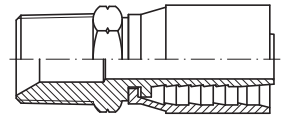

DN	THREAD ROSCA	Part n° Referencia	€
1/4"	1/4" NPT	871610404	18,06
3/8"	3/8" NPT	871610606	21,41
1/2"	1/2" NPT	871610808	26,99
3/4"	3/4" NPT	871611212	40,50
1"	1" NPT	871611616	65,42

Hembras giratorias rectas compactas rosca NPSM cono 60° doble hexagonal

One piece double hexagonal NPSM female 60° cone

Femelle pré-sertie NPSM cono 60° double hexagonal

Femmina diritta compatta NPSM sede 60° doppio esagono

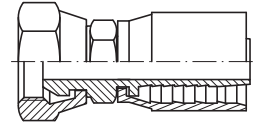

DN	THREAD ROSCA	Part n° Referencia	€
1/4"	1/4" NPSM	873610404	27,26
3/8"	3/8" 18h NPSM	873610606	31,00
1/2"	1/2" 14h NPSM	873610808	40,59
3/4"	3/4" NPSM	873611212	60,43
1"	1" - 11 1/2 h NPSM	873611616	96,41

Conexiones Compactas R7/R8 y Elastómero malla metálica

One piece fittings R7/R8 & Elastomer Braid of steel wire
 Embouts pré-sertis R7/R8 et Elastomère tresse métallique
 Raccordi compatti serie R7/R8 e elastomero treccia metallica

Hembras giratorias rectas compactas rosca Métrica cono 24° - DKO

One piece Metric female 24° cone

Femelle pré-sertie Métrique cone 24°

Femmina diritta compatta Metrica sede 24°

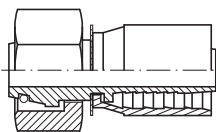

DN	PIPE TUBO	SERIE	THREAD ROSCA	Part n° Referencia	€
1/4"	8	L	M14x1.5	87804140804	17,93
3/8"	12	L	M18x1.5	87804181206	20,94
1/2"	15	L	M22x1.5	87804221508	25,76
3/4"	22	L	M30x2	87804302212	45,91
1"	28	L	M36x2	87804362816	69,36
1/4"	8	S	M16x1.5	87804160804	21,16
3/8"	12	S	M20x1.5	87804201206	26,45
1/2"	16	S	M24x1.5	87804241608	28,32
3/4"	20	S	M30x2	87804302012	56,98
3/4"	25	S	M36x2	87804362512	60,80
1"	30	S	M42x2	87804423016	81,75

Hembras giratorias 90° compactas Métricas cono 24° - DKO 90°

One piece Metric female 24° cone (90° Elbow)

90° Femelle pré-sertie Métrique cone 24°

Femmina 90° compatta Metrica sede 24°

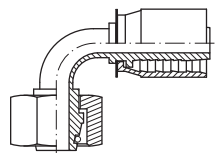

DN	PIPE TUBO	SERIE	THREAD ROSCA	Part n° Referencia	€
1/4"	8	L	M14x1.5	87305140804	29,98
3/8"	12	L	M18x1.5	87305181206	34,25
1/2"	15	L	M22x1.5	87305221508	37,91
3/4"	22	L	M30x2	87305302212	69,59
1"	28	L	M36x2	87305362816	104,61
1/4"	8	S	M16x1.5	87305160804	33,01
3/8"	12	S	M20x1.5	87305201206	36,04
1/2"	16	S	M24x1.5	87305241608	40,80
3/4"	25	S	M36x2	87305362512	92,14
1"	30	S	M42x2	87305423016	132,51

Hembras giratorias 45° compactas Métricas cono 24° - DKO 45°

One piece Metric female 24° cone (45° Elbow)

45° Femelle pré-sertie Métrique cone 24°

Femmina 45° compatta Metrica sede 24°

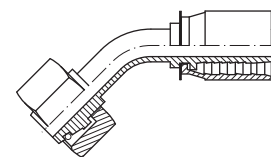

DN	PIPE TUBO	SERIE	THREAD ROSCA	Part n° Referencia	€
1/4"	8	L	M14x1.5	87306140804	29,98
3/8"	12	L	M18x1.5	87306181206	34,25
1/2"	15	L	M22x1.5	87306221508	37,91
3/4"	22	L	M30x2	87306302212	69,59
1"	28	L	M36x2	87306362816	104,61
1/4"	8	S	M16x1.5	87306160804	33,01
3/8"	12	S	M20x1.5	87306201206	36,04
1/2"	16	S	M24x1.5	87306241608	40,80
3/4"	25	S	M36x2	87306362512	92,14
1"	30	S	M42x2	87306423016	132,51

Machos compactos rosca Métrica cono 24°

One piece Metric male 24° cone

Mâle pré-serti Métrique cone 24°

Maschio compatto Metrico sede 24°

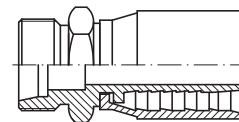

DN	PIPE TUBO	SERIE	THREAD ROSCA	Part n° Referencia	€
1/4"	8	L	M14x1.5	87203140804	21,38
3/8"	12	L	M18x1.5	87203181206	22,36
1/2"	15	L	M22x1.5	87203221508	27,28
3/4"	22	L	M30x2	87203302212	44,65
1"	28	L	M36x2	87203362816	64,69
1/4"	8	S	M16x1.5	87203160804	24,24
3/8"	12	S	M20x1.5	87203201206	28,25
1/2"	16	S	M24x1.5	87203241608	32,25
3/4"	25	S	M36x2	87203362512	54,84
1"	30	S	M42x2	87203423016	87,70

Conexiones Compactas R7/R8 y Elastómero malla metálica

One piece fittings R7/R8 & Elastomer Braid of steel wire
Embouts pré-sertis R7/R8 et Elastomère tresse métallique
Raccordi compatti serie R7/R8 e elastomero treccia metallica

Hembras giratorias rectas compactas rosca BSP cono 60°

One piece BSP female 60° cone

Femelle pré-sertie BSP cone 60°

Femmina diritta compatta BSP sede 60°

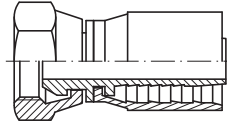

DN	THREAD ROSCA	Part n° Referencia	€
1/4"	1/4" BSP	871000404	17,75
3/8"	3/8" BSP	871000606	20,78
1/2"	1/2" BSP	871000808	24,96
3/4"	3/4" BSP	871001212	40,34
1"	1" BSP	871001616	64,01

Hembras giratorias 90° compactas rosca BSP cono 60°

One piece BSP female 60° cone (90° Elbow)

90° Femelle pré-sertie BSP cone 60°

Femmina 90° compatta BSP sede 60°

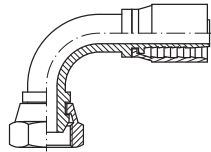

DN	THREAD ROSCA	Part n° Referencia	€
1/4"	1/4" BSP	871070404	26,68
3/8"	3/8" BSP	871070606	29,93
1/2"	1/2" BSP	871070808	37,30
3/4"	3/4" BSP	871071212	61,23
1"	1" BSP	871071616	93,03

Hembras giratorias 45° compactas rosca BSP cono 60°

One piece BSP female 60° cone (45° Elbow)

45° Femelle pré-sertie BSP cone 60°

Femmina 45° compatta BSP sede 60°

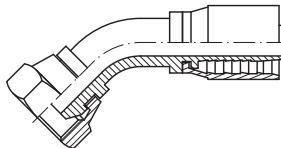

DN	THREAD ROSCA	Part n° Referencia	€
1/4"	1/4" BSP	871080404	26,68
3/8"	3/8" BSP	871080606	29,93
1/2"	1/2" BSP	871080808	37,30
3/4"	3/4" BSP	871081212	61,23
1"	1" BSP	871081616	93,03

Machos compactos rosca cilíndrica BSP cono 60°

One piece BSP male 60° cone

Mâle pré-serti BSP cone 60°

Maschio compatto cilindrico BSP sede 60°

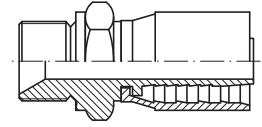

DN	THREAD ROSCA	Part n° Referencia	€
1/4"	1/4" BSP	871120404	18,19
3/8"	3/8" BSP	871120606	21,30
1/2"	1/2" BSP	871120808	27,36
3/4"	3/4" BSP	871121212	41,09
1"	1" BSP	871121616	67,75

Hembras giratorias rectas compactas rosca BSP cono 60° doble hexagonal

One piece double hexagonal BSP female 60° cone

Femelle pré-sertie BSP cone 60° double hexagonal

Femmina diritta compatta BSP sede 60° doppio esagono

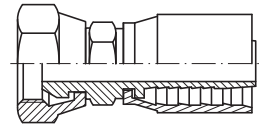

DN	THREAD ROSCA	Part n° Referencia	€
1/4"	1/4" BSP	874000404	25,53
3/8"	3/8" BSP	874000606	28,35
1/2"	1/2" BSP	874000808	33,66
3/4"	3/4" BSP	874001212	55,76
1"	1" BSP	874001616	88,97

Conexiones Compactas PTFE Liso

One piece fittings for Smooth PTFE
Embouts pré-sertis pour PTFE lisse
Raccordi compatti per PTFE liscio

Hembras giratorias rectas compactas rosca JIC 37°

One piece JIC 37° female

Femelle pré-sertie JIC 37°

Femmina diritta compatta JIC 37°

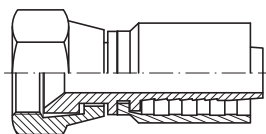

DN	THREAD ROSCA	Part n° Referencia	€
1/4"	7/16" 20h UNF	861420704	17,75
3/8"	9/16" 18h UNF	861420906	20,64
1/2"	3/4" 16h UNF	861421208	25,26
3/4"	1"1/16 12h UN	861421712	38,83
1"	1"5/16 12h UN	861422116	63,05

Hembras giratorias 90° compactas rosca JIC 37°

One piece JIC 37° female (90° Elbow)

90° Femelle pré-sertie JIC 37°

Femmina 90° compatta JIC 37°

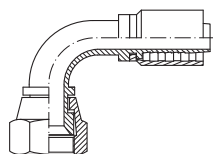

DN	THREAD ROSCA	Part n° Referencia	€
1/4"	7/16" 20h UNF	861380704	28,85
3/8"	9/16" 18h UNF	861380906	31,76
1/2"	3/4" 16h UNF	861381208	34,55
3/4"	1"1/16 12h UN	861381712	59,84
1"	1"5/16 12h UN	861382116	95,16

Hembras giratorias 45° compactas rosca JIC 37°

One piece JIC 37° female (45° Elbow)

45° Femelle pré-sertie JIC 37°

Femmina 45° compatta JIC 37°

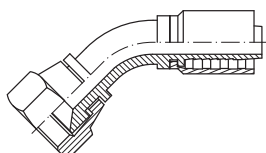

DN	THREAD ROSCA	Part n° Referencia	€
1/4"	7/16" 20h UNF	861390704	28,85
3/8"	9/16" 18h UNF	861390906	31,76
1/2"	3/4" 16h UNF	861391208	34,55
3/4"	1"1/16 12h UN	861391712	59,84
1"	1"5/16 12h UN	861392116	95,16

Machos compactos rosca JIC 37°

One piece JIC 37° male

Mâle pré-serti JIC 37°

Maschio compatto JIC sede 37°

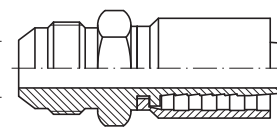

DN	THREAD ROSCA	Part n° Referencia	€
1/4"	7/16" 20h UNF	861400704	21,18
3/8"	9/16" 18h UNF	861400906	23,98
1/2"	3/4" 16h UNF	861401208	27,49
3/4"	1"1/16 12h UN	861401712	38,56
1"	1"5/16 12h UN	861402116	68,03

Hembras giratorias rectas compactas rosca JIC 37° doble hexagonal

One piece JIC 37° double hexagonal female

Femelle pré-sertie JIC 37° double hexagonal

Femmina diritta JIC 37° doppio esagono

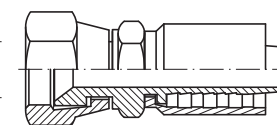

DN	THREAD ROSCA	Part n° Referencia	€
1/4"	7/16" 20h UNF	862420704	21,60
3/8"	9/16" 18h UNF	862420906	24,65
1/2"	3/4" 16h UNF	862421208	28,92
3/4"	1"1/16 12h UN	862421712	46,01
1"	1"5/16 12h UN	862422116	74,43

Conexiones Compactas PTFE Liso

One piece fittings for Smooth PTFE
Emboutis pré-sertis pour PTFE lisse
Raccordi compatti per PTFE liscio

Hembras giratorias rectas compactas rosca ORFS doble hexagonal

One piece doble hexagonal ORFS female

Femelle pré-sertie ORFS double hexagonal

Femmina diritta compatta ORFS

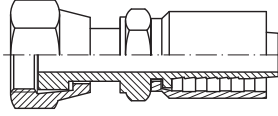

DN	THREAD ROSCA	Part n° Referencia	€
1/4"	9/16-18	869000904	36,05
3/8"	11/16-16	869001106	42,43
1/2"	13/16-16	869001308	47,77
3/4"	1 3/16-12	869001912	72,92
1"	1 7/16-12	869002316	106,22

Hembras giratorias 90° compactas rosca ORFS

One piece ORFS female (90° Elbow)

90° Femelle pré-sertie ORFS

Femmina 90° compatta ORFS

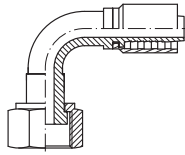

DN	THREAD ROSCA	Part n° Referencia	€
1/4"	9/16-18	869070904	64,41
3/8"	11/16-16	869071106	77,12
1/2"	13/16-16	869071308	82,77
3/4"	1 3/16-12	869071912	141,61
1"	1 7/16-12	869072316	209,92

Hembras giratorias 45° compactas rosca ORFS

One piece ORFS female (45° Elbow)

45° Femelle pré-sertie ORFS

Femmina 45° compatta ORFS

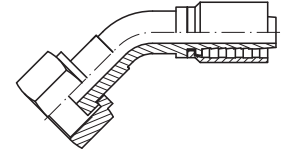

DN	THREAD ROSCA	Part n° Referencia	€
1/4"	9/16-18	869080904	64,41
3/8"	11/16-16	869081106	77,12
1/2"	13/16-16	869081308	82,77
3/4"	1 3/16-12	869081912	141,61
1"	1 7/16-12	869082316	209,92

Machos compactos rosca ORFS

One piece ORFS male

Mâle pré-serti ORFS

Maschio compatto ORFS

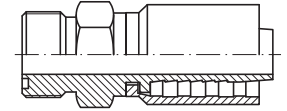

DN	THREAD ROSCA	Part n° Referencia	€
1/4"	9/16-18	869120904	36,12
3/8"	11/16-16	869121106	40,22
1/2"	13/16-16	869121308	46,56
3/4"	1 3/16-12	869121912	87,79
1"	1 7/16-12	869122316	134,32

Conexiones Compactas PTFE Liso

One piece fittings for Smooth PTFE
Embouts pré-sertis pour PTFE lisse
Raccordi compatti per PTFE liscio

Hembras giratorias rectas compactas rosca NPSM cono 60°

One piece NPSM female 60° cone

Femelle pré-sertie NPSM cono 60°

Femmina diritta compatta NPSM sede 60°

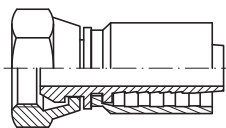

DN	THREAD ROSCA	Part n° Referencia	€
1/4"	1/4" 18h NPSM	862610404	19,19
3/8"	3/8" 18h NPSM	862610606	20,88
1/2"	1/2" 14h NPSM	862610808	25,80
3/4"	3/4" 14h NPSM	862611212	41,23
1"	1" - 11 1/2 h NPSM	862611616	66,80

Hembras giratorias 90° compactas rosca NPSM cono 60°

One piece NPSM female 60° cone (90° Elbow)

90° Femelle pré-sertie NPSM cono 60°

Femmina 90° compatta NPSM sede 60°

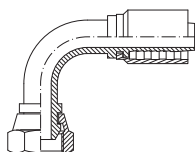

DN	THREAD ROSCA	Part n° Referencia	€
1/4"	1/4" 18h NPSM	862620404	28,98
3/8"	3/8" 18h NPSM	862620606	32,45
1/2"	1/2" 14h NPSM	862620808	38,13
3/4"	3/4" 14h NPSM	862621212	66,77
1"	1" - 11 1/2 h NPSM	862621616	98,57

Hembras giratorias 45° compactas rosca NPSM cono 60°

One piece NPSM female 60° cone (45° Elbow)

45° Femelle pré-sertie NPSM cono 60°

Femmina 45° compatta NPSM sede 60°

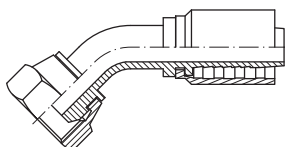

DN	THREAD ROSCA	Part n° Referencia	€
1/4"	1/4" 18h NPSM	862630404	28,98
3/8"	3/8" 18h NPSM	862630606	32,45
1/2"	1/2" 14h NPSM	862630808	38,13
3/4"	3/4" 14h NPSM	862631212	66,77
1"	1" - 11 1/2 h NPSM	862631616	98,57

Machos compactos rosca cónica NPT

One piece NPT male pipe straight

Mâle pré-serti NPT

Maschio compatto conico NPT

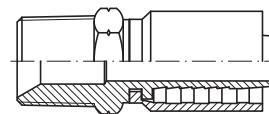

DN	THREAD ROSCA	Part n° Referencia	€
1/4"	1/4" NPT	861610404	16,56
3/8"	3/8" NPT	861610606	19,67
1/2"	1/2" NPT	861610808	24,90
3/4"	3/4" NPT	861611212	36,97
1"	1" NPT	861611616	62,02

Hembras giratorias rectas compactas rosca NPSM cono 60° doble hexagonal

One piece double hexagonal NPSM female 60° cone

Femelle pré-sertie NPSM cono 60° double hexagonal

Femmina diritta compatta NPSM sede 60° doppio esagono

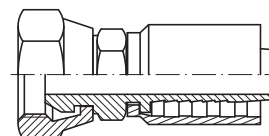

DN	THREAD ROSCA	Part n° Referencia	€
1/4"	1/4" NPSM	863610404	25,76
3/8"	3/8" 18h NPSM	863610606	29,26
1/2"	1/2" 14h NPSM	863610808	38,50
3/4"	3/4" NPSM	863611212	56,90
1"	1" - 11 1/2 h NPSM	863611616	93,01

Conexiones Compactas PTFE Liso

One piece fittings for Smooth PTFE
Embouts pré-sertis pour PTFE lisse
Raccordi compatti per PTFE liscio

Hembras giratorias rectas compactas rosca Métrica cono 24° - DKO

One piece Metric female 24° cone

Femelle pré-sertie Métrique cono 24°

Femmina diritta compatta Metrica sede 24°

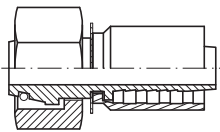

DN	PIPE TUBO	SERIE	THREAD ROSCA	Part n° Referencia	€
1/4"	8	L	M14x1.5	86804140804	16,43
3/8"	12	L	M18x1.5	86804181206	19,20
1/2"	15	L	M22x1.5	86804221508	23,67
3/4"	22	L	M30x2	86804302212	42,38
1"	28	L	M36x2	86804362816	65,96
1/4"	8	S	M16x1.5	86804160804	19,66
3/8"	12	S	M20x1.5	86804201206	24,71
1/2"	16	S	M24x1.5	86804241608	26,23
3/4"	25	S	M36x2	86804362512	57,27
1"	30	S	M42x2	86804423016	78,35

Hembras giratorias 45° compactas rosca Métrica cono 24° - DKO 45°

One piece Metric female 24° cone (45° Elbow)

45° Femelle pré-sertie Métrique cono 24°

Femmina 45° compatta Metrica sede 24°

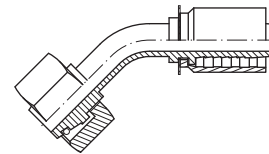

DN	PIPE TUBO	SERIE	THREAD ROSCA	Part n° Referencia	€
1/4"	8	L	M14x1.5	86306140804	28,48
3/8"	12	L	M18x1.5	86306181206	32,51
1/2"	15	L	M22x1.5	86306221508	35,82
3/4"	22	L	M30x2	86306302212	66,06
1"	28	L	M36x2	86306362816	101,21
1/4"	8	S	M16x1.5	86306160804	31,51
3/8"	12	S	M20x1.5	86306201206	34,30
1/2"	16	S	M24x1.5	86306241608	38,71
3/4"	25	S	M36x2	86306362512	88,61
1"	30	S	M42x2	86306423016	129,11

Hembras giratorias 90° compactas rosca Métrica cono 24° - DKO 90°

One piece Metric female 24° cone (90° Elbow)

90° Femelle pré-sertie Métrique cono 24°

Femmina 90° compatta Metrica sede 24°

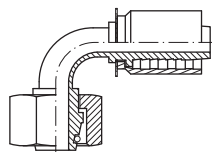

DN	PIPE TUBO	SERIE	THREAD ROSCA	Part n° Referencia	€
1/4"	8	L	M14x1.5	86305140804	28,48
3/8"	12	L	M18x1.5	86305181206	32,51
1/2"	15	L	M22x1.5	86305221508	35,82
3/4"	22	L	M30x2	86305302212	66,06
1"	28	L	M36x2	86305362816	101,21
1/4"	8	S	M16x1.5	86305160804	31,51
3/8"	12	S	M20x1.5	86305201206	34,30
1/2"	16	S	M24x1.5	86305241608	38,71
3/4"	25	S	M36x2	86305362512	88,61
1"	30	S	M42x2	86305423016	129,11

Machos compactos rosca Métrica cono 24°

One piece Metric male 24° cone

Mâle pré-serti Métrique cono 24°

Maschio compatto Metrico sede 24°

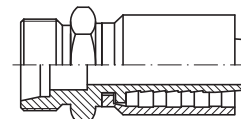

DN	PIPE TUBO	SERIE	THREAD ROSCA	Part n° Referencia	€
1/4"	8	L	M14x1.5	86203140804	19,88
3/8"	12	L	M18x1.5	86203181206	20,62
1/2"	15	L	M22x1.5	86203221508	25,19
3/4"	22	L	M30x2	86203302212	41,12
1"	28	L	M36x2	86203362816	61,29
1/4"	8	S	M16x1.5	86203160804	22,74
3/8"	12	S	M20x1.5	86203201206	26,51
1/2"	16	S	M24x1.5	86203241608	30,16
3/4"	25	S	M36x2	86203362512	51,31
1"	30	S	M42x2	86203423016	84,30

Conexiones Compactas PTFE Liso

One piece fittings for Smooth PTFE
Embouts pré-sertis pour PTFE lisse
Raccordi compatti per PTFE liscio

Hembras giratorias rectas compactas rosca BSP cono 60°

One piece BSP female 60° cone

Femelle pré-sertie BSP cone 60°

Femmina diritta compatta BSP sede 60°

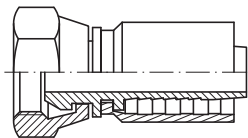

DN	THREAD ROSCA	Part nº Referencia	€
1/4"	1/4" BSP	861000404	16,25
3/8"	3/8" BSP	861000606	19,04
1/2"	1/2" BSP	861000808	22,87
3/4"	3/4" BSP	861001212	36,81
1"	1" BSP	861001616	60,61

Hembras giratorias 90° compactas rosca BSP cono 60°

One piece BSP female 60° cone (90° Elbow)

90° Femelle pré-sertie BSP cone 60°

Femmina 90° compatta BSP sede 60°

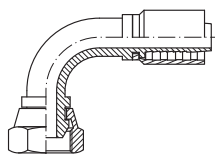

DN	THREAD ROSCA	Part nº Referencia	€
1/4"	1/4" BSP	861070404	25,18
3/8"	3/8" BSP	861070606	28,19
1/2"	1/2" BSP	861070808	35,21
3/4"	3/4" BSP	861071212	57,70
1"	1" BSP	861071616	89,63

Hembras giratorias 45° compactas rosca BSP cono 60°

One piece BSP female 60° cone (45° Elbow)

45° Femelle pré-sertie BSP cone 60°

Femmina 45° compatta BSP sede 60°

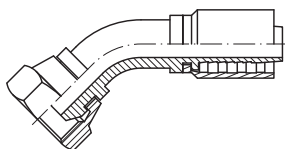

DN	THREAD ROSCA	Part nº Referencia	€
1/4"	1/4" BSP	861080404	25,18
3/8"	3/8" BSP	861080606	28,19
1/2"	1/2" BSP	861080808	35,21
3/4"	3/4" BSP	861081212	57,70
1"	1" BSP	861081616	89,63

Machos compactos rosca cilíndrica BSP cono 60°

One piece BSP male 60° cone

Mâle pré-serti BSP cone 60°

Maschio compatto cilindrico BSP sede 60°

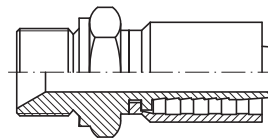

DN	THREAD ROSCA	Part nº Referencia	€
1/4"	1/4" BSP	861120404	16,69
3/8"	3/8" BSP	861120606	19,56
1/2"	1/2" BSP	861120808	25,27
3/4"	3/4" BSP	861121212	37,56
1"	1" BSP	861121616	64,35

Hembras giratorias rectas compactas rosca BSP cono 60° doble hexagonal

One piece double hexagonal BSP female 60° cone

Femelle pré-sertie BSP cone 60° double hexagonal

Femmina diritta compatta BSP sede 60° doppio esagono

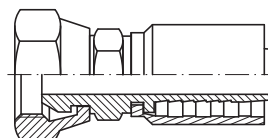

DN	THREAD ROSCA	Part nº Referencia	€
1/4"	1/4" BSP	864000404	24,03
3/8"	3/8" BSP	864000606	26,61
1/2"	1/2" BSP	864000808	31,57
3/4"	3/4" BSP	864001212	52,23
1"	1" BSP	864001616	85,57

Conexiones Compactas PTFE Corrugado

One piece fittings for convoluted PTFE
 Embouts pré-sertis pour PTFE convoluté
 Raccordi compatti per PTFE convoluto

Hembras giratorias rectas compactas rosca JIC 37°

One piece JIC 37° female

Femelle pré-sertie JIC 37°

Femmina diritta compatta JIC 37°

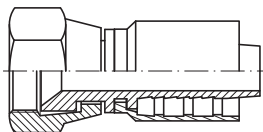

DN	THREAD ROSCA	Part n° Referencia	€
1/4"	7/16" 20h UNF	851420704	18,94
3/8"	9/16" 18h UNF	851420906	20,54
1/2"	3/4" 16h UNF	851421208	27,28
3/4"	1"1/16 12h UN	851421712	41,74
1"	1"5/16 12h UN	851422116	65,97

Hembras giratorias 90° compactas rosca JIC 37°

One piece JIC 37° female (90° Elbow)

90° Femelle pré-sertie JIC 37°

Femmina 90° compatta JIC 37°

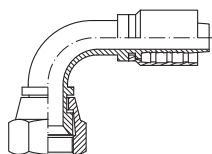

DN	THREAD ROSCA	Part n° Referencia	€
1/4"	7/16" 20h UNF	851380704	30,04
3/8"	9/16" 18h UNF	851380906	31,66
1/2"	3/4" 16h UNF	851381208	36,57
3/4"	1"1/16 12h UN	851381712	62,75
1"	1"5/16 12h UN	851382116	98,08

Hembras giratorias 45° compactas rosca JIC 37°

One piece JIC 37° female (45° Elbow)

45° Femelle pré-sertie JIC 37°

Femmina 45° compatta JIC 37°

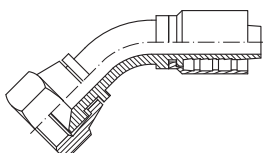

DN	THREAD ROSCA	Part n° Referencia	€
1/4"	7/16" 20h UNF	851390704	30,04
3/8"	9/16" 18h UNF	851390906	31,66
1/2"	3/4" 16h UNF	851391208	36,57
3/4"	1"1/16 12h UN	851391712	62,75
1"	1"5/16 12h UN	851392116	98,08

Machos compactos rosca JIC 37°

One piece JIC 37° male

Mâle pré-serti JIC 37°

Maschio compatto JIC sede 37°

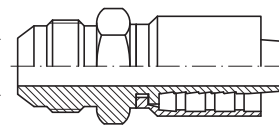

DN	THREAD ROSCA	Part n° Referencia	€
1/4"	7/16" 20h UNF	851400704	22,37
3/8"	9/16" 18h UNF	851400906	23,88
1/2"	3/4" 16h UNF	851401208	29,51
3/4"	1"1/16 12h UN	851401712	41,47
1"	1"5/16 12h UN	851402116	70,95

Hembras giratorias rectas compactas rosca JIC 37° doble hexagonal

One piece JIC 37° double hexagonal female

Femelle pré-sertie JIC 37° double hexagonal

Femmina diritta JIC 37° doppio esagono

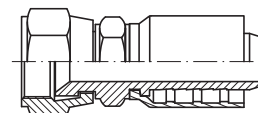

DN	THREAD ROSCA	Part n° Referencia	€
1/4"	7/16" 20h UNF	852420704	22,79
3/8"	9/16" 18h UNF	852420906	24,55
1/2"	3/4" 16h UNF	852421208	30,94
3/4"	1"1/16 12h UN	852421712	48,92
1"	1"5/16 12h UN	852422116	77,35

Conexiones Compactas PTFE Corrugado

One piece fittings for convoluted PTFE
 Embouts pré-sertis pour PTFE convoluté
 Raccordi compatti per PTFE convoluto

Hembras giratorias rectas compactas rosca ORFS doble hexagonal

One piece double hexagonal ORFS female

Femelle pré-sertie ORFS double hexagonal

Femmina diritta compatta ORFS

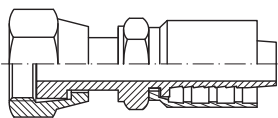

DN	THREAD ROSCA	Part n° Referencia	€
1/4"	9/16-18	859000904	37,24
3/8"	11/16-16	859001106	42,33
1/2"	13/16-16	859001308	49,79
3/4"	1 3/16-12	859001912	75,83
1"	1 7/16-12	859002316	109,14

Hembras giratorias 90° compactas rosca ORFS

One piece ORFS female (90° Elbow)

90° Femelle pré-sertie ORFS

Femmina 90° compatta ORFS

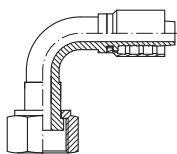

DN	THREAD ROSCA	Part n° Referencia	€
1/4"	9/16-18	859070904	65,60
3/8"	11/16-16	859071106	77,02
1/2"	13/16-16	859071308	84,79
3/4"	1 3/16-12	859071912	144,52
1"	1 7/16-12	859072316	212,84

Hembras giratorias 45° compactas rosca ORFS

One piece ORFS female (45° Elbow)

45° Femelle pré-sertie ORFS

Femmina 45° compatta ORFS

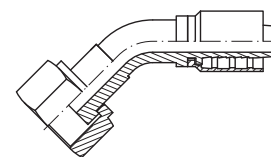

DN	THREAD ROSCA	Part n° Referencia	€
1/4"	9/16-18	859080904	65,60
3/8"	11/16-16	859081106	77,02
1/2"	13/16-16	859081308	84,79
3/4"	1 3/16-12	859081912	144,52
1"	1 7/16-12	859082316	212,84

Machos compactos rosca ORFS

One piece ORFS male

Mâle pré-serti ORFS

Maschio compatto ORFS

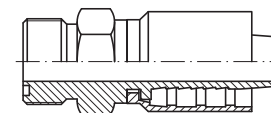

DN	THREAD ROSCA	Part n° Referencia	€
1/4"	9/16-18	859120904	37,31
3/8"	11/16-16	859121106	40,12
1/2"	13/16-16	859121308	48,58
3/4"	1 3/16-12	859121912	90,70
1"	1 7/16-12	859122316	137,24

Conexiones Compactas PTFE Corrugado

One piece fittings for convoluted PTFE
Embouts pré-sertis pour PTFE convoluté
Raccordi compatti per PTFE convoluto

Hembras giratorias rectas compactas rosca NPSM cono 60°

One piece NPSM female 60° cone

Femelle pré-sertie NPSM cono 60°

Femmina diritta compatta NPSM sede 60°

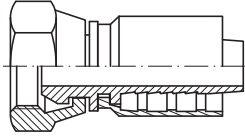

DN	THREAD ROSCA	Part n° Referencia	€
1/4"	1/4" 18h NPSM	852610404	20,38
3/8"	3/8" 18h NPSM	852610606	20,78
1/2"	1/2" 14h NPSM	852610808	27,82
3/4"	3/4" 14h NPSM	852611212	44,14
1"	1" - 11 1/2 h NPSM	852611616	69,72

Hembras giratorias 90° compactas rosca NPSM cono 60°

One piece NPSM female 60° cone (90° Elbow)

90° Femelle pré-sertie NPSM cono 60°

Femmina 90° compatta NPSM sede 60°

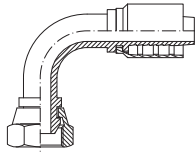

DN	THREAD ROSCA	Part n° Referencia	€
1/4"	1/4" 18h NPSM	852620404	30,17
3/8"	3/8" 18h NPSM	852620606	32,35
1/2"	1/2" 14h NPSM	852620808	40,15
3/4"	3/4" 14h NPSM	852621212	69,68
1"	1" - 11 1/2 h NPSM	852621616	101,49

Hembras giratorias 45° compactas rosca NPSM cono 60°

One piece NPSM female 60° cone (45° Elbow)

45° Femelle pré-sertie NPSM cono 60°

Femmina 45° compatta NPSM sede 60°

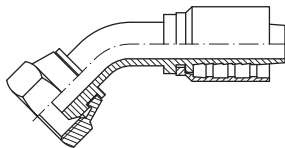

DN	THREAD ROSCA	Part n° Referencia	€
1/4"	1/4" 18h NPSM	852630404	30,17
3/8"	3/8" 18h NPSM	852630606	32,35
1/2"	1/2" 14h NPSM	852630808	40,15
3/4"	3/4" 14h NPSM	852631212	69,68
1"	1" - 11 1/2 h NPSM	852631616	101,49

Machos compactos rosca cónica NPT

One piece NPT male pipe straight

Mâle pré-serti NPT

Maschio compatto conico NPT

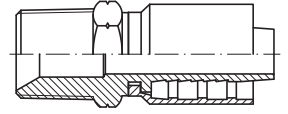

DN	THREAD ROSCA	Part n° Referencia	€
1/4"	1/4" NPT	851610404	17,75
3/8"	3/8" NPT	851610606	19,57
1/2"	1/2" NPT	851610808	26,92
3/4"	3/4" NPT	851611212	39,88
1"	1" NPT	851611616	64,94

Hembras giratorias rectas compactas rosca NPSM cono 60° doble hexagonal

One piece double hexagonal NPSM female 60° cone

Femelle pré-sertie NPSM cono 60° double hexagonal

Femmina diritta compatta NPSM sede 60° doppio esagono

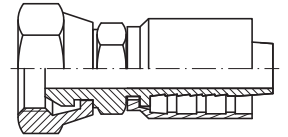

DN	THREAD ROSCA	Part n° Referencia	€
1/4"	1/4" NPSM	853610404	26,95
3/8"	3/8" 18h NPSM	853610606	29,16
1/2"	1/2" 14h NPSM	853610808	40,52
3/4"	3/4" NPSM	853611212	59,81
1"	1" - 11 1/2 h NPSM	853611616	95,93

Conexiones Compactas PTFE Corrugado

One piece fittings for convoluted PTFE
Embouts pré-sertis pour PTFE convoluto
Raccordi compatti per PTFE convoluto

Hembras giratorias rectas compactas rosca Métrica cono 24° - DKO

One piece Metric female 24° cone

Femelle pré-sertie Métrique cone 24°

Femmina diritta compatta Metrica sede 24°

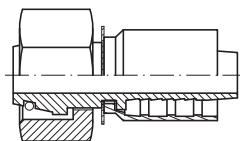

DN	PIPE TUBO	SERIE	THREAD ROSCA	Part nº Referencia	€
1/4"	8	L	M14x1.5	85804140804	17,62
3/8"	12	L	M18x1.5	85804181206	19,10
1/2"	15	L	M22x1.5	85804221508	25,69
3/4"	22	L	M30x2	85804302212	45,29
1"	28	L	M36x2	85804362816	68,88
1/4"	8	S	M16x1.5	85804160804	20,85
3/8"	12	S	M20x1.5	85804201206	24,61
1/2"	16	S	M24x1.5	85804241608	28,25
3/4"	25	S	M36x2	85804362512	60,18
1"	30	S	M42x2	85804423016	81,27

Hembras giratorias 90° compactas rosca Métrica cono 24° - DKO 90°

One piece Metric female 24° cone (90° Elbow)

90° Femelle pré-sertie Métrique cone 24°

Femmina 90° compatta Metrica sede 24°

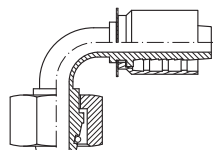

DN	PIPE TUBO	SERIE	THREAD ROSCA	Part nº Referencia	€
1/4"	8	L	M14x1.5	85305140804	29,67
3/8"	12	L	M18x1.5	85305181206	32,41
1/2"	15	L	M22x1.5	85305221508	37,84
3/4"	22	L	M30x2	85305302212	68,97
1"	28	L	M36x2	85305362816	104,13
1/4"	8	S	M16x1.5	85305160804	32,70
3/8"	12	S	M20x1.5	85305201206	34,20
1/2"	16	S	M24x1.5	85305241608	40,73
3/4"	25	S	M36x2	85305362512	91,52
1"	30	S	M42x2	85305423016	132,03

Hembras giratorias 45° compactas rosca Métrica cono 24° - DKO 45°

One piece Metric female 24° cone (45° Elbow)

45° Femelle pré-sertie Métrique cone 24°

Femmina 45° compatta Metrica sede 24°

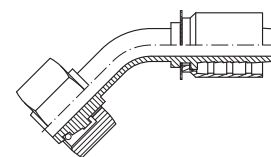

DN	PIPE TUBO	SERIE	THREAD ROSCA	Part nº Referencia	€
1/4"	8	L	M14x1.5	85306140804	29,67
3/8"	12	L	M18x1.5	85306181206	32,41
1/2"	15	L	M22x1.5	85306221508	37,84
3/4"	22	L	M30x2	85306302212	68,97
1"	28	L	M36x2	85306362816	104,13
1/4"	8	S	M10x1.5	85306160804	32,70
3/8"	12	S	M20x1.5	85306201206	34,20
1/2"	16	S	M24x1.5	85306241608	40,73
3/4"	25	S	M36x2	85306362512	91,52
1"	30	S	M42x2	85306423016	132,03

Machos compactos rosca Métrica cono 24°

One piece Metric male 24° cone

Mâle pré-serti Métrique cone 24°

Maschio compatto Metrico sede 24°

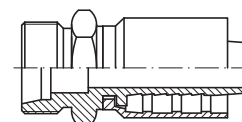

DN	PIPE TUBO	SERIE	THREAD ROSCA	Part nº Referencia	€
1/4"	8	L	M14x1.5	85203140804	21,07
3/8"	12	L	M18x1.5	85203181206	20,52
1/2"	15	L	M22x1.5	85203221508	27,21
3/4"	22	L	M30x2	85203302212	44,03
1"	28	L	M36x2	85203362816	64,21
1/4"	8	S	M16x1.5	85203160804	23,93
3/8"	12	S	M20x1.5	85203201206	26,41
1/2"	16	S	M24x1.5	85203241608	32,18
3/4"	25	S	M36x2	85203362512	54,22
1"	30	S	M42x2	85203423016	87,22

Conexiones Compactas PTFE Corrugado

One piece fittings for convoluted PTFE
Embouts pré-sertis pour PTFE convoluté
Raccordi compatti per PTFE convoluto

Hembras giratorias rectas compactas rosca BSP cono 60°

One piece BSP female 60° cone

Femelle pré-sertie BSP cono 60°

Femmina diritta compatta BSP sede 60°

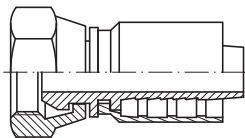

DN	THREAD ROSCA	Part n° Referencia	€
1/4"	1/4" BSP	851000404	17,44
3/8"	3/8" BSP	851000606	18,94
1/2"	1/2" BSP	851000808	24,89
3/4"	3/4" BSP	851001212	39,72
1"	1" BSP	851001616	63,53

Hembras giratorias 90° compactas rosca BSP cono 60°

One piece BSP female 60° cone (90° Elbow)

90° Femelle pré-sertie BSP cono 60°

Femmina 90° compatta BSP sede 60°

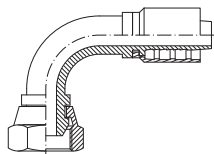

DN	THREAD ROSCA	Part n° Referencia	€
1/4"	1/4" BSP	851070404	26,37
3/8"	3/8" BSP	851070606	28,09
1/2"	1/2" BSP	851070808	37,23
3/4"	3/4" BSP	851071212	60,61
1"	1" BSP	851071616	92,55

Hembras giratorias 45° compactas rosca BSP cono 60°

One piece BSP female 60° cone (45° Elbow)

45° Femelle pré-sertie BSP cono 60°

Femmina 45° compatta BSP sede 60°

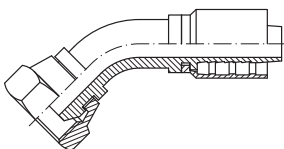

DN	THREAD ROSCA	Part n° Referencia	€
1/4"	1/4" BSP	851080404	26,37
3/8"	3/8" BSP	851080606	28,09
1/2"	1/2" BSP	851080808	37,23
3/4"	3/4" BSP	851081212	60,61
1"	1" BSP	851081616	92,55

Machos compactos rosca cilíndrica BSP cono 60°

One piece BSP male 60° cone

Mâle pré-serti BSP cono 60°

Maschio compatto cilindrico BSP sede 60°

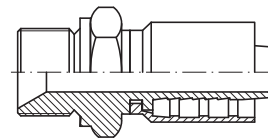

DN	THREAD ROSCA	Part n° Referencia	€
1/4"	1/4" BSP	851120404	17,88
3/8"	3/8" BSP	851120606	19,46
1/2"	1/2" BSP	851120808	27,29
3/4"	3/4" BSP	851121212	40,47
1"	1" BSP	851121616	67,27

Hembras giratorias rectas compactas rosca BSP cono 60° doble hexagonal

One piece double hexagonal BSP female 60° cone

Femelle pré-sertie BSP cono 60° double hexagonal

Femmina diritta compatta BSP sede 60° doppio esagono

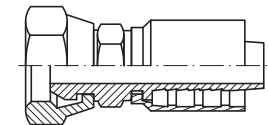

DN	THREAD ROSCA	Part n° Referencia	€
1/4"	1/4" BSP	854000404	25,22
3/8"	3/8" BSP	854000606	26,51
1/2"	1/2" BSP	854000808	33,59
3/4"	3/4" BSP	854001212	55,14
1"	1" BSP	854001616	88,49

Conexiones Compactas Serie BW R12/4SP/4SH

One piece fittings BW Series R12/4SP/4SH
Embouts pré-sertis R12/4SP/4SH Série BW
Raccordi Compatti R12/4SP/4SH Serie BW

Hembras giratorias rectas compactas JIC 37° doble hexagonal

One piece double hexagonal JIC 37° Swivel female

Femelle pré-sertie JIC 37° double hexagonal

Femmina diritta compatta JIC 37° doppio esagono

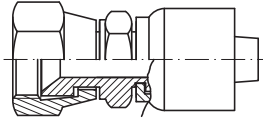

DN	THREAD ROSCA	Part n° Referencia	€
1/2"	3/4" 16h UNF	Z682421208	42,35
5/8"	7/8" 14h UNF	Z682421410	62,68
3/4"	1"1/16 12h UN	Z682421712	90,55
1"	1"5/16 12h UN	Z682422116	130,20
1"1/4	1"5/8 12h UN	Z682422620	270,26
1"1/2	1"7/8 12h UN	Z682423024	398,20
2"	2"1/2 12h UN	Z682424032	604,50

Machos compactos rosca JIC 37° con junta

One piece JIC 37° male with o'ring

Mâle pré-serti JIC 37° avec joint torique

Maschio compatto JIC 37° con o'ring

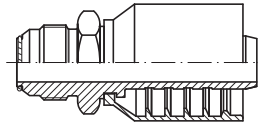

DN	THREAD ROSCA	Part n° Referencia	€
1/2"	3/4" 16h UNF	Z681411208	47,96
5/8"	7/8" 14h UNF	Z681411410	58,46
3/4"	1"1/16 12h UN	Z681411712	83,64
1"	1"5/16 12h UN	Z681412116	111,03
1"1/4	1"5/8 12h UN	Z681412620	155,93
1"1/2	1"7/8 12h UN	Z681413024	190,66
2"	2"1/2 12h UN	Z681414032	368,28

Hembras giratorias rectas compactas NPSM cono 60° doble hexagonal con junta

One piece double hexagonal NPSM female 60° cone with o'ring

Femelle pré-sertie NPSM cono 60° double hexagonal avec joint torique

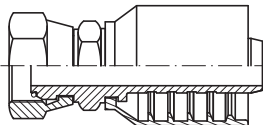

DN	THREAD ROSCA	Part n° Referencia	€
1/2"	1/2" 14h NPSM	Z684610808	50,91
3/4"	3/4" NPSM	Z684611212	93,41
1"	1" NPSM	Z684611616	139,82
1"1/4	1"1/4 NPSM	Z684612020	259,65
1"1/2	1"1/2 NPSM	Z684612424	347,92
2"	2" NPSM	Z684613232	522,92

Hembras giratorias 90° compactas rosca JIC 37°

One piece JIC 37° Swivel female (90° Elbow)

Coude 90° femelle pré-sertie JIC 37°

Femmina gir. compatta 90° JIC 37°

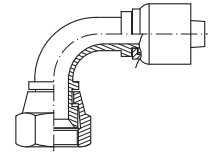

DN	THREAD ROSCA	Part n° Referencia	€
1/2"	3/4" 16h UNF	Z681381208	49,66
5/8"	7/8" 14h UNF	Z681381410	68,61
3/4"	1"1/16 12h UN	Z681381712	89,45
1"	1"5/16 12h UN	Z681382116	128,86
1"1/4	1"5/8 12h UN	Z681382620	188,97
1"1/2	1"7/8 12h UN	Z681383024	275,56
2"	2"1/2 12h UN	Z681384032	527,42

Hembras giratorias 45° compactas rosca JIC 37°

One piece JIC 37° Swivel female (45° Elbow)

Coude 45° femelle pré-sertie JIC 37°

Femmina gir. compatta 45° JIC 37°

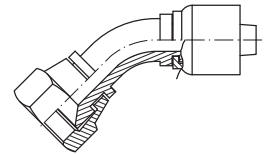

DN	THREAD ROSCA	Part n° Referencia	€
1/2"	3/4" 16h UNF	Z681391208	49,66
5/8"	7/8" 14h UNF	Z681391410	68,61
3/4"	1"1/16 12h UN	Z681391712	89,45
1"	1"5/16 12h UN	Z681392116	128,86
1"1/4	1"5/8 12h UN	Z681392620	188,97
1"1/2	1"7/8 12h UN	Z681393024	274,57
2"	2"1/2 12h UN	Z681394032	524,88

Machos cónicos compactos NPT

One piece NPT Male pipe straight

Mâle pré-serti conique NPT

Maschio compatto conico NPT

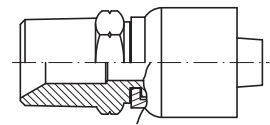

DN	THREAD ROSCA	Part n° Referencia	€
1/2"	1/2" NPT	Z681610808	37,12
3/4"	3/4" NPT	Z681611212	70,05
1"	1" NPT	Z681611616	96,61
1"1/4	1"1/4 NPT	Z681612020	156,43
1"1/2	1"1/2 NPT	Z681612424	221,46
2"	2" NPT	Z681613232	411,41

Conexiones Compactas Serie BW R12/4SP/4SH

One piece fittings BW Series R12/4SP/4SH
Embouts pré-sertis R12/4SP/4SH Série BW
Raccordi Compatti R12/4SP/4SH Serie BW

Hembras giratorias rectas compactas ORFS doble hexagonal

One piece ORFS Swivel female straight double hexagonal

Femelle pré-sertie droite ORFS double hexagonale

Femmina diritta compatta ORFS doppio esagono

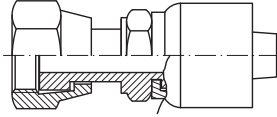

DN	THREAD ROSCA	Part n° Referencia	€
1/2"	13/16-16	Z689011308	66,85
5/8"	1-14	Z689011610	94,34
3/4"	1 3/16-12	Z689011912	111,47
1"	1 7/16-12	Z689012316	157,44
1 1/4"	1 11/16-12	Z689012720	211,37
1 1/2"	2-12	Z689013224	299,14

Hembras giratorias 90° compactas ORFS

One piece ORFS Swivel female (90° Elbow)

Coude 90° femelle pré-sertie ORFS

Femmina 90° compatta ORFS

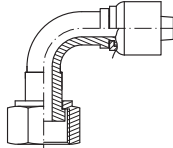

DN	THREAD ROSCA	Part n° Referencia	€
1/2"	13/16-16	Z689071308	112,35
5/8"	1-14	Z689071610	153,08
3/4"	1 3/16-12	Z689071912	252,43
1"	1 7/16-12	Z689072316	362,50
1 1/4"	1 11/16-12	Z689072720	509,46
1 1/2"	2-12	Z689073224	1.375,39

Hembras giratorias rectas compactas rosca Métrica cono 24° con junta tórica

One piece Metric swivel female 24° seat with o'ring

Femelle pré-sertie Métrique 24° avec o'ring

Femmina compatta Metrica sede 24° con o'ring

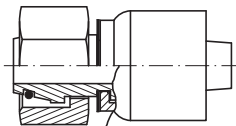

DN	PIPE TUBO	SERIE	THREAD ROSCA	Part n° Referencia	€
1/2"	16	S	M24x1.5	Z68204241608	38,85
3/4"	20	S	M30x2	Z68204302012	80,47
3/4"	25	S	M36x2	Z68204362512	95,33
1"	30	S	M42x2	Z68204423016	111,05
1 1/4"	38	S	M52x2	Z68204523820	162,46

Machos compactos Métricos cono 24°

One piece Metric male stud 24° cone

Mâle pré-serti Métrique cone 24°

Maschio compatto Metrico sede 24° con o'ring

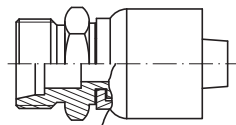

DN	PIPE TUBO	SERIE	THREAD ROSCA	Part n° Referencia	€
1/2"	16	S	M24x1.5	Z68203241608	43,96
3/4"	20	S	M30x2	Z68203302012	83,18
3/4"	25	S	M36x2	Z68203362512	102,75
1"	30	S	M42x2	Z68203423016	122,39
1 1/4"	38	S	M52x2	Z68203523820	197,56

Machos compactos ORFS

One piece ORFS Male

Mâle pré-serti ORFS

Maschio compatto ORFS

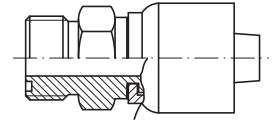

DN	THREAD ROSCA	Part n° Referencia	€
1/2"	13/16-16	Z689121308	65,28
5/8"	1-14	Z689121610	101,20
3/4"	1 3/16-12	Z689121912	162,03
1"	1 7/16-12	Z689122316	233,96
1 1/4"	1 11/16-12	Z689122720	329,66
1 1/2"	2-12	Z689123224	479,21

Hembras giratorias 45° compactas ORFS

One piece ORFS Swivel female (45° Elbow)

Coude 45° femelle pré-sertie ORFS

Femmina 45° compatta ORFS

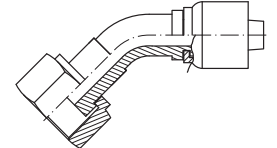

DN	THREAD ROSCA	Part n° Referencia	€
1/2"	13/16-16	Z689081308	112,35
5/8"	1-14	Z689081610	153,08
3/4"	1 3/16-12	Z689081912	252,43
1"	1 7/16-12	Z689082316	362,50
1 1/4"	1 11/16-12	Z689082720	509,46
1 1/2"	2-12	Z689083224	1.375,39

Hembras giratorias 90° compactas métricas cono 24° con junta tórica

One piece Metric swivel female 24° seat with o'ring (90° Elbow)

Coude 90° femelle pré-sertie Métrique 24° avec o'ring

Femmina compatta Metrica 90° sede 24° con o'ring

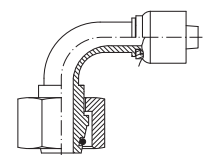

DN	PIPE TUBO	SERIE	THREAD ROSCA	Part n° Referencia	€
1/2"	16	S	M24x1.5	Z68205241608	55,07
3/4"	20	S	M30x2	Z68205302012	100,38
3/4"	25	S	M36x2	Z68205362512	131,87
1"	30	S	M42x2	Z68205423016	167,19
1 1/4"	38	S	M52x2	Z68205523820	224,83

Hembras giratorias 45° compactas Métricas cono 24° con junta tórica

One piece Metric swivel female 24° seat with o'ring (45° Elbow)

Coude 45° femelle pré-sertie Métrique 24° avec o'ring

Femmina compatta Metrica 45° sede 24°

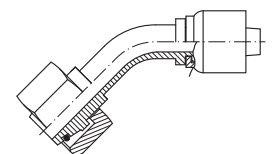

DN	PIPE TUBO	SERIE	THREAD ROSCA	Part n° Referencia	€
1/2"	16	S	M24x1.5	Z68206241608	55,07
3/4"	20	S	M30x2	Z68206302012	101,40
3/4"	25	S	M36x2	Z68206362512	131,87
1"	30	S	M42x2	Z68206423016	167,19
1 1/4"	38	S	M52x2	Z68206523820	224,83

Conexiones Compactas Serie BW R12/4SP/4SH

One piece fittings BW Series R12/4SP/4SH
Embouts pré-sertis R12/4SP/4SH Série BW
Raccordi Compatti R12/4SP/4SH Serie BW

Crimp fittings for hoses

Pipe fittings DIN 2353

Flare fittings JIC 37° / SAE Flanges

Adaptors

Welding fittings

Industrial fittings

Couplings, Ball valves and Hydraulic Components

Hembras giratorias rectas compactas BSP 60° doble hexagonal con junta

One piece double hexagonal BSP Swivel female cone 60° with o'ring

Femelle pré-sertie BSP cone 60° double hexagonal avec o'ring

Femmina diritta compatta BSP sede 60° doppio esagono con o'ring

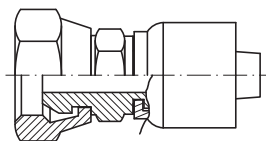

DN	THREAD ROSCA	Part nº Referencia	€
1/2"	1/2" BSP	Z684000808	49,24
5/8"	5/8" BSP	Z684001010	75,64
3/4"	3/4" BSP	Z684001212	90,58
1"	1" BSP	Z684001616	135,24
1"1/4	1"1/4 BSP	Z684002020	250,25
1"1/2	1"1/2 BSP	Z684002424	335,43
2"	2" BSP	Z684003232	649,16

Hembras giratorias 90° compactas BSP 60° con junta tórica

One piece BSP Swivel female 60° cone with o'ring (90° Elbow)

Coude 90° femelle pré-sertie BSP 60° avec o'ring

Femmina 90° compatta BSP sede 60° con o'ring

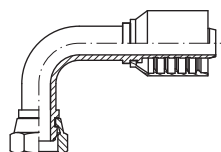

DN	THREAD ROSCA	Part nº Referencia	€
1/2"	1/2" BSP	Z681170808	65,81
5/8"	5/8" BSP	Z681171010	95,58
3/4"	3/4" BSP	Z681171212	90,30
1"	1" BSP	Z681171616	124,35
1"1/4	1"1/4 BSP	Z681172020	186,83
1"1/2	1"1/2 BSP	Z681172424	278,26
2"	2" BSP	Z681173232	483,83

Hembras giratorias 45° compactas BSP 60°

One piece BSP Swivel female 60° cone with o'ring (45° Elbow)

Coude 45° femelle pré-sertie BSP 60° avec o'ring

Femmina 45° compatta BSP sede 60° con o'ring

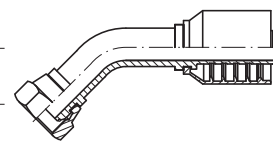

DN	THREAD ROSCA	Part nº Referencia	€
1/2"	1/2" BSP	Z681180808	65,81
5/8"	5/8" BSP	Z681181010	95,58
3/4"	3/4" BSP	Z681181212	90,59
1"	1" BSP	Z681181616	123,93
1"1/4	1"1/4 BSP	Z681182020	186,01
1"1/2	1"1/2 BSP	Z681182424	278,26
2"	2" BSP	Z681183232	483,83

Machos cilíndricos compactos BSP 60°

One piece BSP Male 60° cone

Mâle pré-serti gaz cylindrique BSP 60°

Maschio compatto BSP cilindrico sede 60°

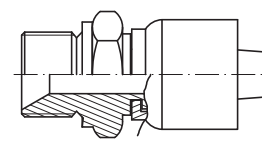

DN	THREAD ROSCA	Part nº Referencia	€
1/2"	1/2" BSP	Z681120808	37,60
5/8"	5/8" BSP	Z681121010	58,44
3/4"	3/4" BSP	Z681121212	75,00
1"	1" BSP	Z681121616	99,30
1"1/4	1"1/4 BSP	Z681122020	159,45
1"1/2	1"1/2 BSP	Z681122424	220,90
2"	2" BSP	Z681123232	406,13

Conexiones Compactas Serie BW R12/4SP/4SH

One piece fittings BW Series R12/4SP/4SH
Embouts pré-sertis R12/4SP/4SH Série BW
Raccordi Compatti R12/4SP/4SH Serie BW

Bridas rectas compactas SAE 3000 PSI

One piece 3000 PSI SAE Straight Flange / Code 61

Bride SAE droite pré-sertie série 3000 PSI

Flangia diritta compatta SAE 3000

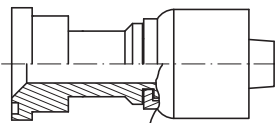

DN	Ø	Part n° Referencia	€
1/2"	30.2	Z681820808	73,17
5/8"	38.1	Z681821210	95,43
3/4"	38.1	Z681821212	94,66
1"	44.5	Z681821616	119,02
1"1/4	50.8	Z681822020	188,00
1"1/2	60.3	Z681822424	246,27
2"	71.4	Z681823232	390,02

Bridas rectas compactas SAE 6000 PSI

One piece 6000 PSI SAE Straight Flange / Code 62

Bride SAE droite pré-sertie série 6000 PSI

Flangia diritta compatta SAE 6000

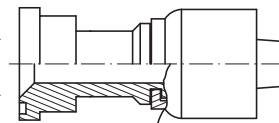

DN	Ø	Part n° Referencia	€
1/2"	30.2	Z682820808	77,13
5/8"	38.1	Z682821210	121,69
3/4"	41.3	Z682821212	103,29
1"	47.6	Z682821616	126,90
1"1/4	54	Z682822020	189,88
1"1/2	63.5	Z682822424	248,40
2"	79.4	Z682823232	402,42

Bridas 90° compactas SAE 3000 PSI

One piece 3000 PSI SAE Flange (90° Elbow) / Code 61

Bride SAE coude 90° pré-sertie série 3000 PSI

Flangia 90° compatta SAE 3000

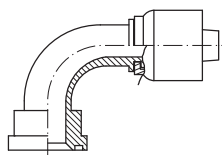

DN	Ø	Part n° Referencia	€
1/2"	30.2	Z681830808	93,24
5/8"	38.1	Z681831210	138,50
3/4"	38.1	Z681831212	121,50
1"	44.5	Z681831616	173,59
1"1/4	50.8	Z681832020	228,03
1" 1/2	60.3	Z681832424	365,72
2"	71.4	Z681833232	532,63

Bridas 90° compactas SAE 6000 PSI

One piece 6000 PSI SAE Flange (90° Elbow) / Code 62

Bride SAE coude 90° pré-sertie série 6000 PSI

Flangia 90° compatta SAE 6000

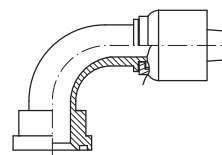

DN	Ø	Part n° Referencia	€
1/2"	30.2	Z682830808	93,51
5/8"	38.1	Z682831210	148,36
3/4"	41.3	Z682831212	127,78
1"	47.6	Z682831616	175,09
1"1/4	54	Z682832020	234,43
1"1/2	63.5	Z682832424	371,32
2"	79.4	Z682833232	546,10

Bridas 45° compactas SAE 3000 PSI

One piece 3000 PSI SAE Flange (45° Elbow) / Code 61

Bride SAE coude 45° pré-sertie série 3000 PSI

Flangia 45° compatta SAE 3000

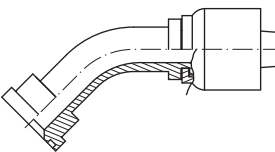

DN	Ø	Part n° Referencia	€
1/2"	30.2	Z681840808	93,24
5/8"	38.1	Z681841210	138,65
3/4"	38.1	Z681841212	121,50
1"	44.5	Z681841616	173,59
1"1/4	50.8	Z681842020	228,03
1" 1/2	60.3	Z681842424	365,72
2"	71.4	Z681843232	532,63

Bridas 45° compactas SAE 6000 PSI

One piece 6000 PSI SAE Flange (45° Elbow) / Code 62

Bride SAE coude 45° pré-sertie série 6000 PSI

Flangia 45° compatta SAE 6000

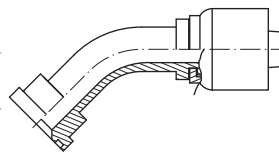

DN	Ø	Part n° Referencia	€
1/2"	30.2	Z682840808	93,51
5/8"	38.1	Z682841210	148,36
3/4"	41.3	Z682841212	127,78
1"	47.6	Z682841616	175,09
1"1/4	54	Z682842020	234,43
1"1/2	63.5	Z682842424	371,32
2"	79.4	Z682843232	546,11

Casquillos para Conexiones Compactas

Ferrules for one piece fittings
Jupes pour embouts pré-sertis
Boccole per raccordi compatti

Casquillos R1AT/R2AT/1SN/2SN /R16/2SC para conexiones compactas serie 43

Ferrules R1AT/R2AT/1SN/2SN/R16/2SC for one piece fittings 43 series

Jupes R1AT/R2AT/1SN/2SN/R16/2SC pour embouts pré-sertis série 43

Boccole a pressione R1AT/R2AT/1SN/2SN/R16/2SN per raccordi compatti serie 43

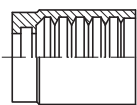

DN	Part n° Referencia	€
1/4"	ZPFC221200400	9,00
5/16"	ZPFC221200500	9,85
3/8"	ZPFC221200600	11,85
1/2"	ZPFC221200800	13,55
5/8"	ZPFC221201000	15,92
3/4"	ZPFC221201200	23,44
1"	ZPFC221201600	34,61
1"1/4	ZPFC221202000	54,68
1"1/2	ZPFC221202400	73,07
2"	ZPFC221203200	92,64

Casquillos R7, R8 y elastómero malla metálica para conexiones compactas

Ferrules R7, R8 and braid of steel wire for one piece fittings

Jupes R7, R8 et elastomère tresse métallique pour embouts pré-sertis

Boccole a pressione R7, R8 per raccordi compatti

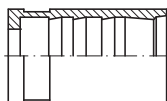

DN	Part n° Referencia	€
3/16"	880120300	8,19
1/4"	880120400	8,05
5/16"	880120500	9,28
3/8"	880120600	9,50
1/2"	880120800	10,59
3/4"	880121200	16,72
1"	880121600	26,90

Casquillos PTFE Liso para conexiones compactas

Ferrules smooth PTFE for one piece fittings

Jupes PTFE Lisse pour embouts pré-sertis

Boccole a pressione PTFE liscio per raccordi compatti

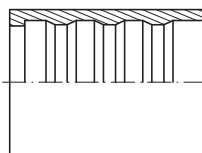

DN	Part n° Referencia	€
1/4"	880400400	6,55
5/16"	880400500	7,51
3/8"	880400600	7,76
1/2"	880400800	8,50
5/8"	880401000	10,27
3/4"	880401200	13,19
1"	880401600	23,50

Casquillos PTFE Corrugado para conexiones compactas

Ferrules convoluted PTFE for one piece fittings

Jupes PTFE Convoluté pour embouts pré-sertis

Boccole a pressione PTFE corrugato per raccordi compatti

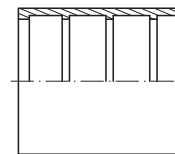

DN	Part n° Referencia	€
1/4"	880410400	7,74
5/16"	880410500	6,73
3/8"	880410600	7,66
1/2"	880410800	10,52
5/8"	880411000	13,70
3/4"	880411200	16,10
1"	880411600	26,42

Casquillos 1SC/1SN/2SC/R6

Ferrules 1SC/1SN/2SC/R6

Jupes 1SC/1SN/2SC/R6

Boccole a pressione per 1SC/1SN/2SC/R6

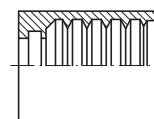

DN	Part n° Referencia	€
1/4"	ZSCC21120400	8,95
5/16"	ZSCC21120500	9,01
3/8"	ZSCC21120600	10,50
1/2"	ZSCC21120800	11,60
5/8"	ZSCC21121000	15,18
3/4"	ZSCC21121200	21,85
1"	ZSCC21121600	29,85

Casquillos R12/4SP/4SH para conexiones serie BW

Ferrules R12/4SP/4SH for fittings BW series

Jupes R12/4SP/4SH pour embouts série BW

Boccole a pressione per R12/4SP/4SH per raccordi serie BW

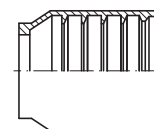

DN	Part n° Referencia	€
1/2"	ZAC680100800	15,82
5/8"	ZAC680101000	20,40
3/4"	ZAC680101200	33,84
1"	ZAC680101600	43,49
1"1/4	ZAC680102000	62,19
1"1/2	ZAC680102400	85,60
2"	ZAC680103200	139,52

Conexiones Reusables

Reusable series
Embouts série récupérable
Serie Recuperabile

Casquillos reusables para manguera R1A pelar

Reusable ferrules R1A skive

Jupes récupérables R1A avec dénudage

Boccola recuperabile R1A con pelatura

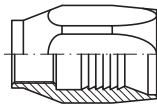

DN	Part n° Referencia	€
1/4"	Z1G-4 R1 INOX	24,04
5/16"	Z1G-5 R1 INOX	25,34
3/8"	Z1G-6 R1 INOX	23,98
1/2"	Z1G-8 R1 INOX	27,76
5/8"	Z1G-10 R1 INOX	43,69
3/4"	Z1G-12 R1 INOX	50,07
1"	Z1G-16 R1 INOX	84,92

Hasta fin de existencias / Until end of stock / Jusqu'à la fin du stock / Fino ad esaurimento scorta

Casquillos reusables para manguera R1T no pelar

Reusable ferrules R1T non skive

Jupes récupérables R1T sans dénudage

Boccola recuperabile per R1T senza pelatura

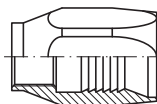

DN	Part n° Referencia	€
1/4"	Z1G-4 R1T INOX	24,04
5/16"	Z1G-5 R1T INOX	25,34
3/8"	Z1G-6 R1T INOX	23,98
1/2"	Z1G-8 R1T INOX	27,76
3/4"	Z1G-12 R1T INOX	31,09
1"	Z1G-16 R1T INOX	*
1"1/4	Z1G-20 R1T INOX	*

Hembras giratorias rectas reusables rosca BSP cono 60°

Reusable BSP Swivel female 60° cone

Femelle récupérable gaz cylindrique 60°

Femmina diritta BSP sede 60° recuperabile

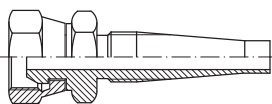

DN	THREAD ROSCA	Part n° Referencia	€
1/4"	1/4" BSP	Z3G-4	33,10
5/16"	3/8" BSP	Z3G-6-5	36,81
3/8"	3/8" BSP	Z3G-6	35,54
3/8"	1/2" BSP	Z3G-8-6	40,52
1/2"	1/2" BSP	Z3G-8	40,45
5/8"	1/2" BSP	Z3G-8-10 *	59,25
3/4"	3/4" BSP	Z3G-12	62,76
1"	1" BSP	Z3G-16	107,32
1"1/4	1"1/4 BSP	Z3G-20	209,10
1"1/2	1"1/2 BSP	Z3G-24	252,99

*Hasta fin de existencias. / *Until end of stock. / *Jusqu'à la fin du stock. / *Fino ad esaurimento scorta.

Casquillos reusables para manguera R2A pelar

Reusable ferrules R2A skive

Jupes récupérables R2A avec dénudage

Boccola recuperabile per R2A con pelatura

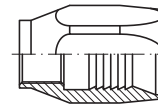

DN	Part n° Referencia	€
5/16"	Z1G-5 R2 INOX	21,92
1"	Z1G-16 R2 INOX	76,14
1"1/2	Z1G-24 R2 INOX	195,39

Hasta fin de existencias / Until end of stock / Jusqu'à la fin du stock / Fino ad esaurimento scorta

Casquillos reusables para manguera R2AT no pelar

Reusable ferrules R2AT non skive

Jupes récupérables R2AT sans dénudage

Boccola recuperabile per R2AT senza pelatura

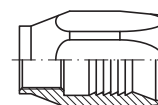

DN	Part n° Referencia	€
1/4"	Z1G-4 R2T INOX	21,23
3/8"	Z1G-6 R2T INOX	23,98
5/8"	Z1G-10 R2T INOX	49,02
1/2"	Z1G-8 R2T INOX	28,03
3/4"	Z1G-12 R2T INOX	50,70
1"	Z1G-16 R2T INOX	76,14

Hembras giratorias 90° reusables rosca BSP cono 60°

Reusable BSP Swept elbow 60° cone (90° Elbow)

Coude 90° femelle récupérable gaz cylindrique BSP 60°

Femmina 90° BSP sede 60° recuperabile

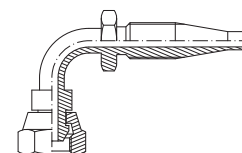

DN	THREAD ROSCA	Part n° Referencia	€
1/4"	1/4" BSP	Z90G-4	58,91
3/8"	3/8" BSP	Z90G-6	59,24
3/8"	1/2" BSP	Z90G-8-6	87,29
1/2"	1/2" BSP	Z90G-8	87,29
3/4"	3/4" BSP	Z90G-12	112,88
1"	1" BSP	Z90G-16	184,82

Conexiones Reusables

Reusable series
Embouts série récupérable
Serie Recuperabile

Machos reusables rosca cilíndrica BSP cono 60°

Reusable BSP Male parallel 60° cone

Mâle récupérable gaz cylindrique BSP 60°

Maschio BSP cilindrico sede 60° recuperabile

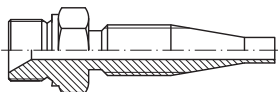

DN	THREAD ROSCA	Part n° Referencia	€
1/4"	1/4" BSP	Z2G-4	33,10
3/8"	3/8" BSP	Z2G-6	35,00
5/16"	3/8" BSP	Z2G-6-5	35,65
1/2"	1/2" BSP	Z2G-8	38,73
3/8"	1/2" BSP	Z2G-8-6	40,94
3/4"	3/4" BSP	Z2G-12	65,10
1"	1" BSP	Z2G-16	*
1"1/4	1"1/4 BSP	Z2G-20	*

Espigas lisas Métricas reusables

Reusable Metric standpipe

Embout lisse récupérable Métrique

Estremità tubolare recuperabile

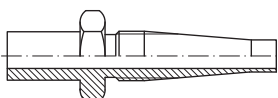

DN	PIPE TUBO	Part n° Referencia	€
1/4"	6	ZE-6-4	30,88
1/4"	8	ZE-8-4	29,38
3/8"	8	ZE-8-6	28,53
1/4"	10	ZE-10-4	29,38
5/16"	10	ZE-10-5	29,79
3/8"	10	ZE-10-6	42,70
5/16"	12	ZE-12-5	29,79
3/8"	12	ZE-12-6	42,70
3/8"	15	ZE-15-6	42,70
1/2"	15	ZE-15-8	41,91
1/2"	16	ZE-16-8	41,89
3/4"	22	ZE-22-12	63,50
3/4"	25	ZE-25-12	88,00
1"	25	ZE-25-16	*
1"	28	ZE-28-16	*
1"	30	ZE-30-16	*

Hembras giratorias rectas reusables rosca JIC cono 37°

Reusable JIC 37° straight Swivel female

Femelle droite récupérable JIC 37°

Femmina diritta JIC sede 37° recuperabile

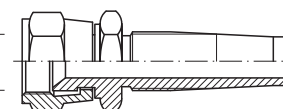

DN	THREAD ROSCA	Part n° Referencia	€
1/4"	7/16" 20h UNF	Z3J-07-04	*
3/8"	9/16" 18h UNF	Z3J-09-06	*
1/2"	3/4" 16h UNF	Z3J-12-08	*
1/2"	7/8" 14h UNF	Z3J-14-08	*
5/8"	7/8" 14h UNF	Z3J-14-10	*
3/4"	1"1/16" 12h UNF	Z3J-17-12	*
1"	1" 5/16" 12h UNF	Z3J-21-16	*

Machos reusables rosca JIC cono 37°

Reusable JIC 37° cone

Mâle récupérables JIC cône 37°

Maschio JIC 37°

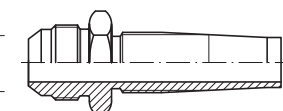

DN	THREAD ROSCA	Part n° Referencia	€
1/4"	7/16" 20h UNF	Z2J-07-04	*
3/8"	9/16" 18h UNF	Z2J-09-06	*
1/2"	7/8" 14h UNF	Z2J-14-08	*
1/2"	3/4" 16h UNF	Z2J-12-08	*
5/8"	7/8" 14h UNF	Z2J-14-10	*
3/4"	1"1/16" 12h UNF	Z2J-17-12	*
1"	1" 5/16" 12h UNF	Z2J-21-16	*

Conexiones Push-On

Push-On Fittings
Embouts Push-On
Raccordi Serie Push-On

Hembras giratorias rectas rosca BSP cono 60°

BSP Swivel female 60° cone

Femelle tournante BSP cono 60°

Femmina diritta BSP sede 60°

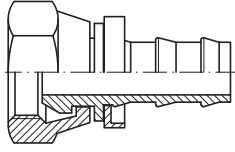

DN	THREAD ROSCA	Part nº Referencia	€
1/4"	1/4" BSP	891000404	9,97
3/8"	3/8" BSP	891000606	12,28
1/2"	1/2" BSP	891000808	16,65
5/8"	5/8" BSP	891001010	24,82
3/4"	3/4" BSP	891001212	25,74
1"	1" BSP	891001616	40,76

Machos rosca cilíndrica BSP cono 60°

BSP Male 60° cone

Mâle fixe BSP cono 60°

Maschio BSP cilindrico sede 60°

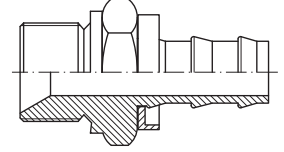

DN	THREAD ROSCA	Part nº Referencia	€
1/4"	1/4" BSP	891120404	14,44
3/8"	3/8" BSP	891120606	15,84
1/2"	1/2" BSP	891120808	18,83
3/4"	1/2" BSP	891120812	31,86
5/8"	5/8" BSP	891121010	32,13
3/4"	3/4" BSP	891121212	42,72
1"	1" BSP	891121616	53,06

Hembras giratorias rectas JIC 37°

JIC 37° Swivel female

Femelle tournante JIC 37°

Femmina diritta JIC sede 37°

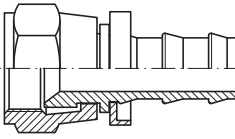

DN	THREAD ROSCA	Part nº Referencia	€
1/4"	7/16" 20h UNF	891420704	11,76
3/8"	9/16" 18h UNF	891420906	12,61
1/2"	3/4" 16h UNF	891421208	16,34
5/8"	7/8" 14h UNF	891421410	22,62
3/4"	1" 1/16 12h UN	891421712	26,25
1"	1" 5/16 12h UN	891422116	45,54

Machos rosca JIC cono 37°

JIC 37° Male

Mâle fixe JIC 37°

Maschio JIC sede 37°

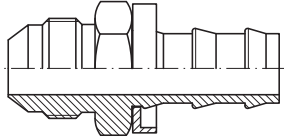

DN	THREAD ROSCA	Part nº Referencia	€
1/4"	7/16" 20h UNF	891400704	15,25
3/8"	9/16" 18h UNF	891400906	17,19
1/2"	3/4" 16h UNF	891401208	19,50
5/8"	7/8" 14h UNF	891401410	31,19
3/4"	1" 1/16 12h UN	891401712	37,77
1"	1" 5/16 12h UN	891402116	47,69

Machos rosca cónica NPT

NPT Male pipe straight

Mâle gaz conique NPT (BRIGGS)

Maschio NPT conico

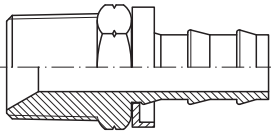

DN	THREAD ROSCA	Part nº Referencia	€
1/4"	1/4" NPT	891610404	13,40
3/8"	3/8" NPT	891610606	14,89
1/2"	1/2" NPT	891610808	16,86
3/4"	3/4" NPT	891611212	26,56
1"	1" NPT	891611616	38,50

Hembra giratoria recta Métrica cono 24°

Metric female swivel with o'ring 24° cone

Femelle Métrique avec o'ring cône 24°

Femmina Metrica sede 24° con o'ring

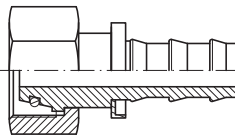

DN	PIPE TUBO	SERIE	THREAD ROSCA	Part nº Referencia	€
1/4"	8	L	M14x1.5	89804140804	13,22
1/4"	10	L	M16x1.5	89804161004	16,79
3/8"	12	L	M18x1.5	89804181206	15,50
1/2"	15	L	M22x1.5	89804221508	17,35
3/4"	22	L	M30x2	89804302212	29,93

Machos rosca métrica cono 24°

Metric stud 24° cone

Mâle Métrique cône 24°

Maschio Metrico sede 24°

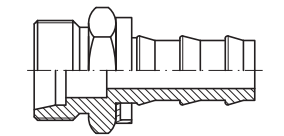

DN	PIPE TUBO	SERIE	THREAD ROSCA	Part nº Referencia	€
1/4"	8	L	M14x1.5	89203140804	15,42
1/4"	10	L	M16x1.5	89203161004	17,70
3/8"	12	L	M18x1.5	89203181206	17,80
1/2"	15	L	M22x1.5	89203221508	19,29
3/4"	22	L	M30x2	89203302212	32,43

Conexiones Alta Presión (700 bar)

High pressure 700 bar fittings
Embouts haute pression 700 bar
Raccordi Altissima pressione (700 bar)

Casquillos para alta presión (700bar)

Ferrules for thermoplastic hose 700 bar

Jupes à sertir thermoplastique 700 bar

Boccole per tubo termoplastico 700 bar

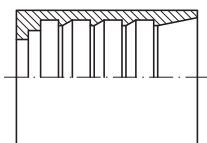

DN	Part n° Referencia	€
1/4"	Z710120400	35,33
3/8"	Z710120600	36,73
1/2"	Z710120800	38,94

Hembra giratoria BSP cono 60° (700bar)

BSP Swivel female 60° cone 700 bar

Embout 700 bar femelle tournante gaz cyl BSP 60°

Femmina diritta BSP sede 60° 700 bar

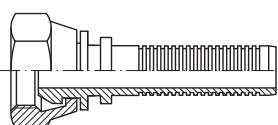

DN	THREAD ROSCA	Part n° Referencia	€
1/4"	1/4" BSP	Z741000404	60,98
3/8"	3/8" BSP	Z741000606	64,16
1/2"	1/2" BSP	Z741000808	66,74

Macho BSP cono 60° (700bar)

BSP Male parallel 60° cone 700 bar

Embout 700 bar mâle fixe gaz cyl BSP 60°

Maschio cilindrico BSP sede 60° 700 bar

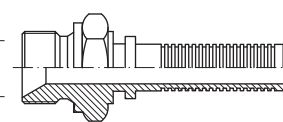

DN	THREAD ROSCA	Part n° Referencia	€
1/4"	1/4" BSP	Z741120404	70,33
3/8"	3/8" BSP	Z741120606	72,63
1/2"	1/2" BSP	Z741120808	78,69

Hembra giratoria NPSM cono 60° (700bar)

NPSM Swivel female 60° cone 700 bar

Embout 700 bar femelle tournante NPSM 60°

Femmina diritta NPSM sede 60° 700 bar

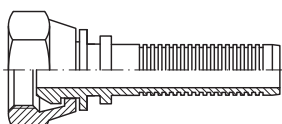

DN	THREAD ROSCA	Part n° Referencia	€
1/4"	1/4" 18h NPSM	Z742610404	60,98
3/8"	3/8" 18h NPSM	Z742610606	64,16
1/2"	1/2" 14h NPSM	Z742610808	66,74

Macho NPT (700bar)

NPT Male pipe straight 700 bar

Embout 700 bar mâle fixe gaz conique NPT

Maschio conico NPT 700 bar

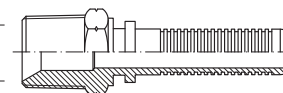

DN	THREAD ROSCA	Part n° Referencia	€
1/4"	1/4" NPT	Z741610404	70,33
1/4"	3/8" NPT	Z741610604	76,26
3/8"	3/8" NPT	Z741610606	72,63
1/2"	1/2" NPT	Z741610808	78,69

Hembra giratoria JIC 37° (700bar)

JIC 37° Swivel female 700 bar

Embout 700 bar femelle tournante droit JIC 37°

Femmina JIC 37° 700 bar

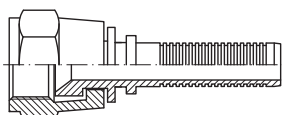

DN	THREAD ROSCA	Part n° Referencia	€
1/4"	7/16" 20h UNF	Z741420704	67,08
1/4"	9/16" 18h UNF	Z741420904	71,21
3/8"	9/16" 18h UNF	Z741420906	70,58
1/2"	3/4" 16h UNF	Z741421208	73,42

Macho JIC 37° (700bar)

JIC 37° Male thread 700 bar

Embout 700 bar mâle fixe JIC 37°

Maschio JIC 37° 700 bar

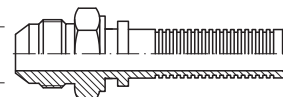

DN	THREAD ROSCA	Part n° Referencia	€
1/4"	7/16" 20h UNF	Z741400704	77,36
3/8"	9/16" 18h UNF	Z741400906	79,89
1/2"	3/4" 16h UNF	Z741401208	86,56

Conexiones Alta Presión (700 bar)

High pressure 700 bar fittings

Embouts haute pression 700 bar

Raccordi Altissima pressione (700 bar)

Hembra giratoria Métrica 24° (700bar)

Metric Swivel female 24° cone 700 bar

Embout 700 bar femelle tournante droit
Métrique cone 24°

Femmina diritta Metrica sede 24° 700 bar

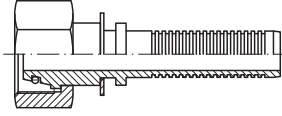

DN	PIPE TUBO	SERIE	THREAD ROSCA	Part nº Referencia	€
1/4"	8	S	M16x1.5	Z74804160804	89,86
3/8"	12	S	M20x1.5	Z74804201206	82,85
1/2"	16	S	M24x1.5	Z74804241608	82,29

Macho Métrico 24° (700bar)

Metric Male 24° cone 700 bar

Embout 700 bar mâle fixe Métrique cone 24°

Maschio cilindrico Metrico sede 24° 700 bar

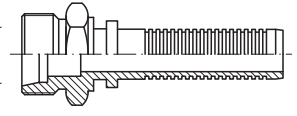

DN	PIPE TUBO	SERIE	THREAD ROSCA	Part nº Referencia	€
1/4"	8	S	M16x1.5	Z74203160804	89,32
3/8"	12	S	M20x1.5	Z74203201206	99,85
1/2"	16	S	M24x1.5	Z74203241608	111,38

Conexiones Micro-hose

Micro-hose fittings
Embouts Minimess
Raccordi Micro-tubo

Casquillos AISI-303

Ferrules AISI-303

Jupes AISI-303

Boccole AISI-303

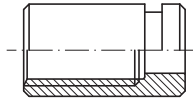

DN	Part n° Referencia	€
2	Z555010100	2,66

Hembra asiento plano con junta manómetro

Swivel female flat seat with o'ring for manometer
Micro-hose

Embout femelle tournante fond plat avec o'ring
pour manomètre Minimess

Femmina sede piana con o'ring per manometro

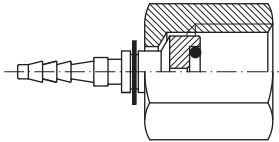

DN	THREAD ROSCA	Part n° Referencia	€
2	1/4" BSP	Z555050404	16,11
2	1/2" BSP	Z555050808	21,33

Hembra giratoria de control

Check Metric swivel female Micro-hose

Embout femelle tournante de control Métrique
Minimess

Presca di pressione femmina

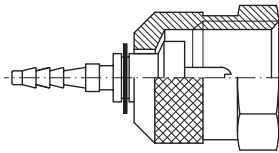

DN	THREAD ROSCA	Part n° Referencia	€
2	M16X2	Z555069523	20,25

Hembra as. 60°

Straight swivel female BSP 60° cone micro-hose

Embout femelle tournante gaz cyl BSP 60°
Minimess

Femmina girevole BSP

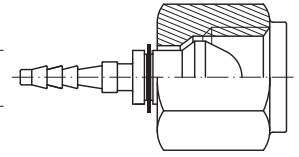

DN	THREAD ROSCA	Part n° Referencia	€
2	1/4" BSP	Z555040404	30,90

Espiga lisa Métrica

Metric standpipe Micro-hose

Embout lisse Métrique Minimess

Estremità tubolare Metrica

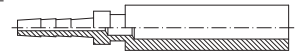

DN	PIPE TUBO	Part n° Referencia	€
2	6	Z555070600	7,73
2	8	Z555070800	10,76

Macho de control

Straight Micro-hose check male

Embout mâle manomètre

Presca di pressione maschio

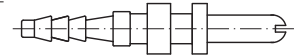

DN	Part n° Referencia	€
2	Z555030325	9,18

Conexiones Micro-hose

Micro-hose fittings
Embouts Minimesse
Raccordi Micro-tubo

Racores de control macho

Male check couplings

Prises de pression mâle

Mini-prese di controllo maschio

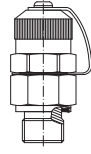

THREAD ROSCA	DESCRIPTION DESCRIPCIÓN	Part n° Referencia	€
1/4" BSP	16x2	Z MPR 1/4 G	39,14
M10x1	16x2	Z MPR M10	75,95

Toma de control M16x2 / Test coupling M16x2 / Prise de pression M16x2 / Presa di pressione M16x2

Racores de control TLM

TLM Check couplings

Prises de pression TLM

Mini-prese di controllo TLM

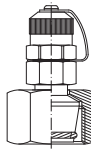

PIPE TUBO	SERIE	THREAD ROSCA	Part n° Referencia	€
6	L	M12x1.5	Z MPR TLM 6L	94,33
8	L	M14x1.5	Z MPR TLM 8L	96,78
10	L	M16x1.5	Z MPR TLM 10L	102,90
12	L	M18x1.5	Z MPR TLM 12L	98,00
6	S	M14x1.5	Z MPR TLM 6S	95,55
8	S	M16x1.5	Z MPR TLM 8S	96,78
10	S	M18x1.5	Z MPR TLM 10S	105,35
12	S	M20x1.5	Z MPR TLM 12S	104,13

Toma de control M16x2 / Test coupling M16x2 / Prise de pression M16x2 / Presa di pressione M16x2

Racor de control intermedio para tubo metálico

Halfway check fitting for metal tube

Raccord intermédiaire pour tube métallique

Mini prese di controllo Intermedia per tubo metallico

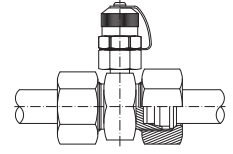

PIPE TUBO	SERIE	Part n° Referencia	€
6	L	Z MPR DL 6	102,90
8	L	Z MPR DL 8	107,80
10	L	Z MPR DL 10	116,38
12	L	Z MPR DL 12	105,35
15	L	Z MPR DL 15	115,15
18	L	Z MPR DL 18	132,30
22	L	Z MPR DL 22	149,45
28	L	Z MPR DL 28	226,63
35	L	Z MPR DL 35	238,88
42	L	Z MPR DL 42	218,05
6	S	Z MPR DS 6	102,90
8	S	Z MPR DS 8	112,70
10	S	Z MPR DS 10	120,05
12	S	Z MPR DS 12	111,48
14	S	Z MPR DS 14	129,85
16	S	Z MPR DS 16	120,05
20	S	Z MPR DS 20	153,13
25	S	Z MPR DS 25	189,88
30	S	Z MPR DS 30	230,30
38	S	Z MPR DS 38	230,30

Toma de control M16x2 / Test coupling M16x2 / Prise de pression M16x2 / Presa di pressione M16x2

- Ø → Ø Prensado · Ø Crimping · Ø de sertissage
- E → Pelado Exterior · Ext. Skive · Dénudage extérieur
- L → Longitud Prensado · Crimping Length · Longueur Sertissage
- I → Pelado Interior · Int. Skive · Dénudage intérieur

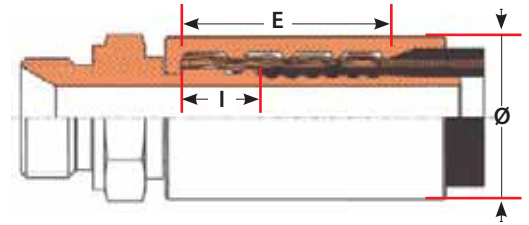

Los datos que aparecen son recomendados para nuestras mangueras TRALE/TRIAGLE (MS/ML)

This crimping chart is the one we recommend for our hoses TRALE/TRIAGLE (MS/ML) · Ce tableau de sertissage est celui que nous recommandons pour nos tuyaux TRALE/TRIAGLE (MS/ML)

Los Ø de Prensado deben ser verificados con los calibres pasa / no pasa

The crimping diameters must be verified with the go/ no go gauge · Les diamètres de sertissage doivent être vérifiées avec le calibre entre/ n'entre pas

Las dimensiones indicadas son mm

The dimensions are indicated in mm · Les dimensions son indiquées en mm

Para consultar Ø de manguera ver tabla dimensional de mangueras

To consult hose diameter see the dimensional hoses chart · Pour consulter le Ø du tuyau, voir la table dimensionnelle des tuyaux

Datos de tablas siempre actualizados en nuestra web www.dicsaes.com

Information des tableaux toujours actualisés sur notre web www.dicsaes.com · Crimping information always updated on our website www.dicsaes.com

Manguera Hidráulica. Tabla de Prensado para Casquillos en Acero Inoxidable.

Hydraulic Hoses. Crimping chart for stainless steel.

	Manguera Hose	Serie Casquillo Ferrule	DN	5	6	8	10	12	16	19	25	31	38	51		
			A mm	3/16"	1/4"	5/16"	3/8"	1/2"	5/8"	3/4"	1"	1"1/4"	1"1/2"	2"		
Conexiones Estándar · Standard Series	NO PELADO · NO SKIVE	EN 857 / 1SC 1SC	ZSC2112	Ø	16,7	16,1	18,7	23,6	27,3	30,7	39					
		EN 853 1SN/ SAE 100 R1AT 2230			16,3	16,9	18,7	23	28	30,9	39					
	NO PELADO · NO SKIVE	EN 857 / 2SC EN 857 2SC 2SC 2SCNL	ZPF2212	Ø	18,1	18,9	20,9	23,6	27,6	31	39					
		EN 853 1SN/ SAE 100 R1AT 2230			17,7	18,9	20,8	23	30,9	39						
	PELADO EXTERIOR · EXT. SKIVE	EN 853 2SN/ SAE 100 R2AT 3511	ZPF2212	Ø	15,7	17,4	18,6	20,8	22,9	27	30	39	47,8	56	70	
		EN 853 2ST/ SAE 100 R2A 3509			16,2	18	19,8	21,8	24,2	28,2	32,1	40,5	50,8	59	71,5	
		PELADO EXTERIOR · EXT. SKIVE	EN 856 4SP/ SAE 100 R9R 4290/4248	ZPF1224	Ø	18,2	17,6	20	22,5	26,3	29,1	33,8	42,2	51	59	72,3
			EN 856 R12/ SAE 100 R12 4612			E	22,5	21	22	23	23,5	24,5	31,5	38	45	49
	Conexiones Interlock · Interlock Series	PELADO EXTERIOR-INTERIOR · INT.- EXT SKIVE	EN 856 4SH 4569	ZA61010	Ø						35,5	42	50	57	74	
					E						52	57	67	77	82	
I										17	18	21	24	26		
PELADO EXTERIOR-INTERIOR · INT.- EXT SKIVE		EN 856 R13/ SAE 100 R13 4713	ZA61010	Ø							36	42,5				
				E						52	57					
				I						17	18					
PELADO EXTERIOR-INTERIOR · INT.- EXT SKIVE		SAE 100 R15 4815	Z61010	Ø									55	64	79	
				E									67	77	82	
				I									21	24	26	
PELADO EXTERIOR-INTERIOR · INT.- EXT SKIVE		SAE 100 R15 4815	ZA610	Ø								42				
	E										57					
	I											18				
PELADO EXTERIOR-INTERIOR · INT.- EXT SKIVE	SAE 100 R15 4815	Z610	Ø									54,5	64			
			E									64	77			
			I										21	24		
BW SERIES	SAE 100 R9R EN 856 4SP	ZAC68010...	Ø	Solución BW en 2 piezas sin pelar No Skive 2 pieces solution BW series						34,5	42	54	60,5			
	SAE 100 R12 EN 856 R12		Ø	36,4	42,5	51,7	59,5									
	EN 856 4SH		Ø	35,1	41,8	51	58,5									

Tablas de Prensados

Crimping Chart | Table de sertissage

Manguera Termoplástica. Tabla de Prensado para Casquillos en Acero Inoxidable.

Thermoplastic Hoses. Crimping chart for stainless steel.

	Manguera Hose	Serie Casquillo Ferrule	DN	3	5	6	8	10	12	16	19	25	31	38	51	63
			A mm	1/8"	3/16"	1/4"	5/16"	3/8"	1/2"	5/8"	3/4"	1"	1"1/4"	1"1/2"	2"	2" 1/2"
Conexiones Estándar - Standard Series	PTFE FHL M29000"	81014	Ø		11,5	13	13,8	15,5	20,5	23,5	27	34				
	PTFE FHM 2 MALLAS M29012	81014	Ø			13,6	14,6	17,5	20,5	23,5	27,5	34,1				
		81040	Ø			13,6	14,6	17,5	20,7	25,2	34,5	34,5				
	PTFE CONV M2920	81041	Ø		11,5	12,2	14	16,8	20,2	24	26,3	34	39	48,2	60,2	74
	SAE100 R7 MT07-MT27	81014	Ø	11	11,2	14,6	16,5	18,6	23	26	28,4		37			
	SAE100 R8 MT08-MT28		Ø		11,1	14,3	15,7	18,3	23	26	29		37			
	EMM MT09		Ø		11,1	14,5	15,8	18,5	22	25	28		36,5			
EMM PINTURA MT099	Ø			11,1		16,5		22				36,5				
	82003	Ø			17,9		21			31						
Pint	E2MM PINTURA MT299	ZPF1224	Ø			17,3	19	22	26		30,6		41			
Alta	ALTISIMA PRESION M700	Z71012	Ø			16,6		22,8	28,5							
Mini	MINIMESS MT01	Z555	Ø	7												
Alim	PTFE CONV M2920	81050	Ø									34,5	42,5	48,7	61,5	
Limp	ECOLOGY MEC200	Z2120	Ø									35,9	43,5			

Tabla de Prensados para Conexiones Compactas en Acero Inoxidable

Crimping chart for compact fittings in stainless steel.

	Manguera Hose	Serie Casquillo Ferrule	DN	6	8	10	12	16	19	25	31	38	51
			A mm	1/4"	5/16"	3/8"	1/2"	5/8"	3/4"	1"	1"1/4"	1"1/2"	2"
43 SERIES	SAE R1AT EN 853 1SN	*ZPFC12...1	Ø	16,3	18,9	21	24,2	27,5	31,6	39,4			
			L	23,6	24	23,5	26,4	29,8	34,9	42			
	SAE 100 R2AT EN 853 2SN	*ZPFC12...1	Ø	17,4	20,1	22,6	25,3	28,5	32,9	41,3	51,8	60	72,5
	EN 857 2SC	*ZPFC12...1	L	23,1	24	23,5	26,4	29,8	34,9	42			
Ø			17,4		22,3	24,6	28,5	32	40,2				
TERMOP.	SAE 100 R7 EN 855 R7	88012...	L	23,6		23,5	26,4	29,8	34,9	42			
			Ø	14,6	15,9	18,6	23	26	28,4	37			
L	28,2		29,7	30,3	31,7	33,2	38	46,3					
Ø	14,3		15,7	18,3	23,2	26	29	37					
BW SERIES	SAE 100 R9R EN 856 4SP	ZAC68010...	L	28,2	29,7	30,3	31,7	33,2	38	46,3			
			Ø						34,5	42	54	60,5	
	L							43	48,5	60,5	60		
	Ø							36,4	42,5	51,7	59,5		
SAE 100 R12 EN 856 R12	L						43	48,5	60,5	60			
	Ø						35,1	41,8	51	58,5			
EN 856 4SH	L						43	48,5	60,5	60			
	Ø												
PTFE	PTFE LISO SMOOYH	88040...	L	13		16,5	20,5		27	33,1			
			Ø	27,8		27,3	29,3		36,2	46,3			
	PTFE CORRUGADO CONVOLUTED	88041...	L	12,2	14	16,1	19,2						
			Ø	27,8	28	27,3	30,3						

*Nuevo Diseño Casquillo - New Desing

Máquinas tratamiento tubo flexible

Machines for mounting flexibles

Machines pour le montage des flexibles

Macchine per l'assemblaggio di tubi flessibili

SE 28 (1 1/4" 4 SP)



PE 58 (2" 6 SP)



SPEBDEG



CHMT-20 (1 1/4")



CHM4-32D (2")



PBC-32



Portarrollos

Roll-Holder
Porte-Rouleaux
Portarotoli



Banco de pruebas BE 1500 / BE 2500

Testing bank BE 1500 / BE 2500
Banque d'essais BE 1500 / BE 2500
Banco de prova BE 1500 / BE 2500



Pipe fittings DIN 2353

Flare fittings JIC 37° / SAE Flanges

Adaptors

Welding fittings

Industrial fittings

Couplings, Ball valves and Hydraulic Components

Racores para tubo rígido DIN 2353

Pipe fittings DIN 2353

Raccord tube rigide DIN 2353

Raccordi ad anello DIN 2353

Tubo rígido

Rigid pipe
Tube rigide
Tubo rigido

91

Racores DIN 2353

DIN 2353 Pipe fittings
Raccords à bague DIN 2353
Raccordi DIN 2353

92

Abrazaderas

Clamps
Colliers
Collari fissatubo

111

2

Una solución eficaz, económica y sencilla para prevenir el goteo en las conducciones de tubo rígido

An effective, cheap and single solution to prevent leaks in pipe fittings

Une solution efficace, économique et simple pour prévenir les fuites dans les embouts pour tube rigide

Una soluzione efficace, economica e semplice per prevenire perdite dai raccordi per tubo rigido



■ Óptima prevención de fugas

Good leakage prevention

Bonne prévention de fuites

Buona prevenzione delle perdite

Larga durabilidad

Long shelf life

Longue durée

Lunga durata

Fácil montaje, revisión y sustitución

Easy assembly, inspection, replacement

Facil montage, inspection et substitution

Facile montaggio, ispezione e sostituzione

Protección antivibraciones

Anti-vibration and unscrewing protection

Protection anti-vibration

Antivibrazione e protezione allo svitamento

Excelente resistencia a altas temperaturas y fluidos agresivos

Excellent resistance to high temperatures and aggressive fluids

Excellent resistance aux hautes températures et fluides agressifs

Eccellente resistenza alle alte temperature e fluidi aggressivi

■ Información técnica

Technical data

Information technique

Informazione tecnica

Material Material Matériel Materiale	Temperatura Temperature Temperature Temperatura	Durabilidad Self life Durée Durata
FKM verde 70/80 sh Green FKM 70/80 sh FKM vert 70/80 sh FKM verde 70/80 sh	-35 °C + 100 °C	5 años 5 year 5 an 5 anni

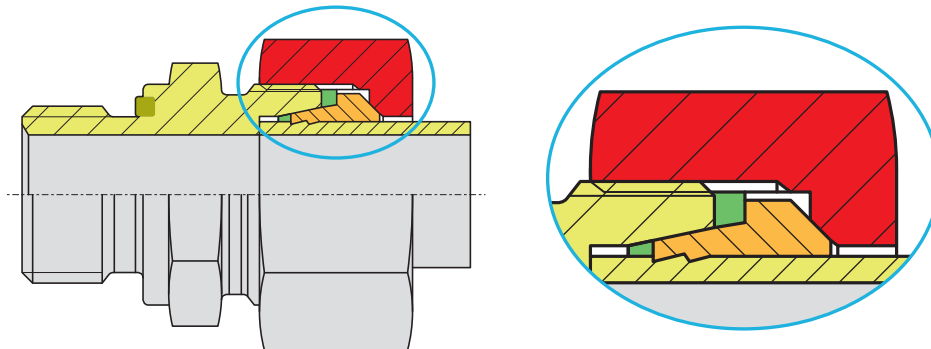

Racores DIN 2353

DIN 2353 Pipe fittings
Raccords à bague DIN 2353
Raccordi DIN 2353

Instrucciones de montaje del racor DIN 2353 sobre el tubo rígido (se recomienda el uso de herramientas de premontaje)

Assembly of the pipe fittings DIN 2353 in the rigid pipe (It is recommended to use pre-assembly tools)

Instructions de montage du raccord DIN 2353 sur le tube rigide (Nous recommandons l'utilisation d'outils)

Assemblaggio del raccordo ad anello DIN 2353 nel tubo rigido (è si consiglia l'uso degli utensili di premontaggio)

A. Preparación del tubo

Preparation of the tube

Préparation du tube

Preparazione del tubo

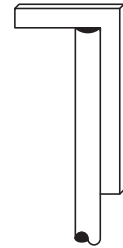
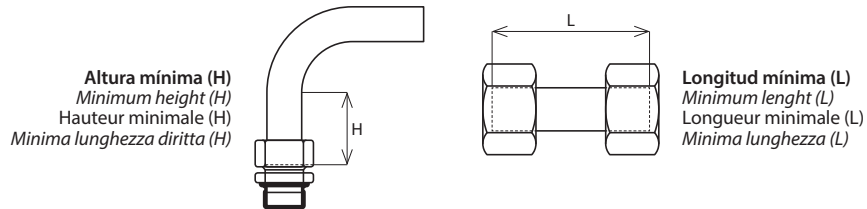

Cortar el tubo a escuadra y eliminar rebabas.
Rectangularly saw off the pipe and remove all burrs.
Couper le tube à angle droit et entever les bavures.
Tagliare il tubo ad angolo retto ed eliminare i residui metallici.

	Serie / Series / Série / Serie		
	LL	L	S
Ø exterior Ø outer Ø extérieur Ø esterno	4-5-6-8	6-8-10-12-15-18-22-28-35-42	6-8-10-12-14-16-20-25-30-38
H mínimo H minimum H minimum H minimo	24-25-25-26	31-31-33-33-36-38-42-42-48-48	35-35-37-37-43-43-50-54-58-65
L mínimo L minimum L minimum L minimo	30-32-32-33	39-39-42-42-45-48-53-53-60-60	44-44-47-47-54-54-63-68-73-82

B. Lubricar adecuadamente

Lubricate properly

Lubrifier convenablement

Lubrificare convenientemente

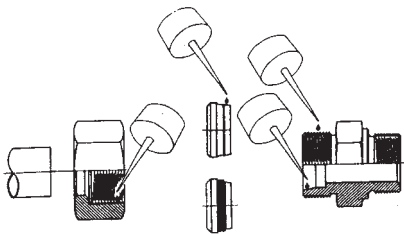

C. Montaje

Assembly

Montage

Montaggio

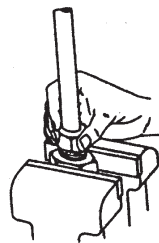

D. Apriete

Blocking

Blockage

Bloccaggio

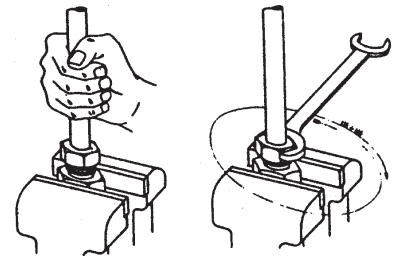

E. Control

Control

Control

Controllo

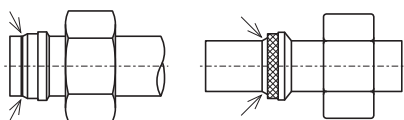

F. Montaje final

Final assembly

Montage final

Montaggio finale

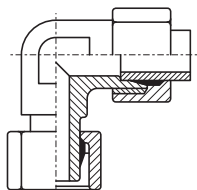

G. Montajes posteriores

Later assemblies

Montages postérieurs

Montaggio successivo

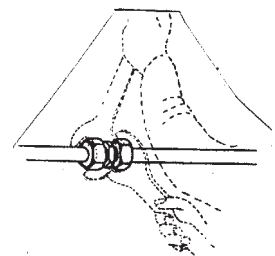

Tubo rígido

Rigid pipe
Tube rigide
Tubo rigido

■ **Tubo rígido / Rigid pipe / Tube rigide / Tubo rigido**



ZTH0



ZTH0...-3

Racores DIN 2353

DIN 2353 Pipe fittings
Raccords à bague DIN 2353
Raccordi DIN 2353

Tuercas y anillos / Nuts and cutting rings / Écrous et bagues / Dadi e anelli

92

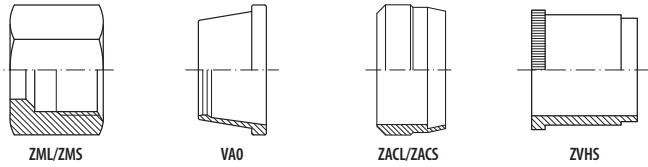

Uniones tubo-tubo / Straight couplings / Raccords union double / Raccordi intermedi

93

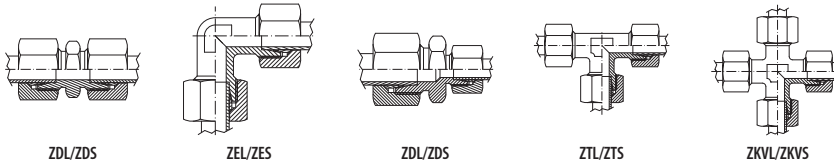

Uniones rectas tubo-rosca / Straight male stud couplings / Raccords union simple mâle / Raccordi di estremità diritti

95

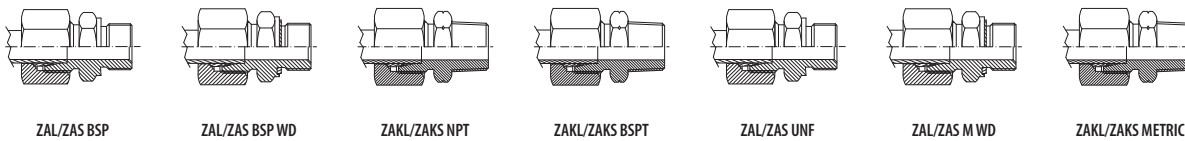

Codos tubo-rosca / Male stud elbows / Raccords coude mâle gaz / Raccordi di estremità a 90°

98

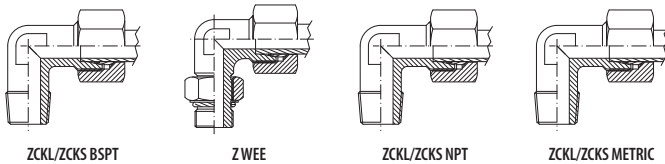

TES rosca central / Male stud branch / Raccords Té mâle central / Raccordi di estremità a T

99

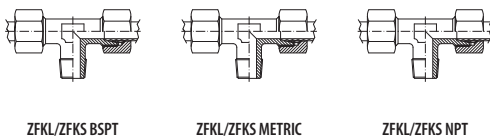

TES rosca lateral / Male stud barrel / Raccords Té mâle latéral / Raccordi di estremità a L

99

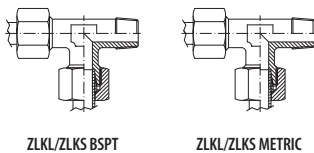

Uniones Métricas / Metric unions / Raccords union Métrique / Raccordi Metrici

100

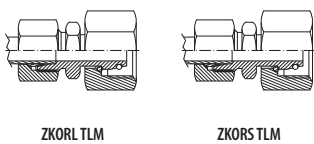

Reducciones roscadas / Reducers / Raccords réduction / Raccordi di riduzione filettati

101

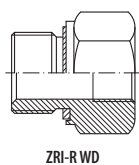

Racores DIN 2353

DIN 2353 Pipe fittings
Raccords à bague DIN 2353
Raccordi DIN 2353

■ Racores regulables / Adjustable stud couplings / Raccords réglables / Raccordi orientabili

| 102

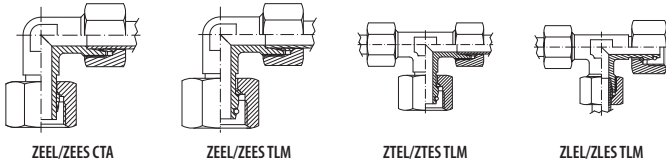

ZEEL/ZEES CTA

ZEEL/ZEES TLM

ZTEL/ZTES TLM

ZLEL/ZLES TLM

■ Tubo roscado (hembra giratoria) / Adjustable straight stud / Raccords tube fileté / Raccordi di estremità per combinazioni

| 103

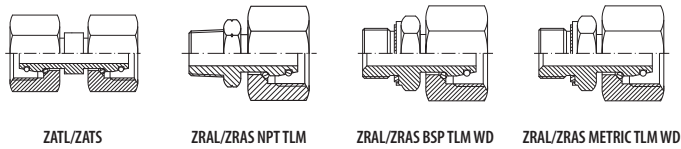

ZATL/ZATS

ZRAL/ZRAS NPT TLM

ZRAL/ZRAS BSP TLM WD

ZRAL/ZRAS METRIC TLM WD

■ Soldables / Weld / Raccords à souder / Raccordi a saldare

| 104

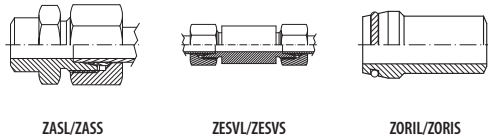

ZASL/ZASS

ZESVL/ZESVS

ZORIL/ZORIS

■ Pasatabiques / Bulkhead / Raccords passe cloison / Raccordi di attraversamento

| 105

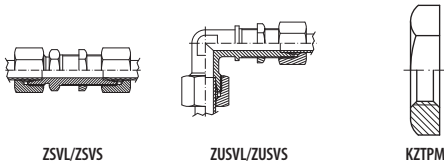

ZSVL/ZSVS

ZUSVL/ZUSVS

KZTPM

■ Racor recto hembra / Straight female coupling / Raccords droits femelle / Raccordi diritti con estremità femmina

| 106

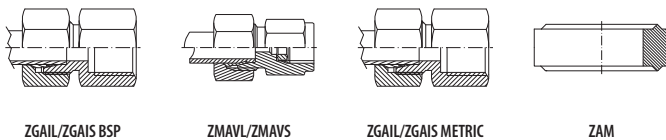

ZGAIL/ZGAIS BSP

ZMAVL/ZMAVS

ZGAIL/ZGAIS METRIC

ZAM

■ Orientables / Banjos / Raccords orientables / Raccordi orientabili ad occhio

| 107

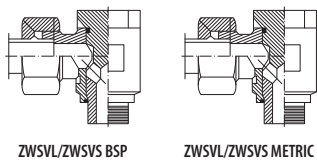

ZWSVL/ZWSVS BSP

ZWSVL/ZWSVS METRIC

■ Tapones / Plugs / Raccords bouchon métrique / Tappi

| 108

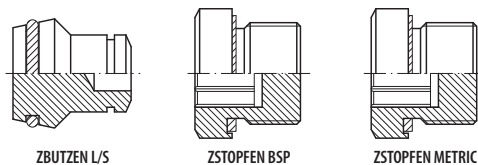

ZBUTZEN L/S

ZSTOPFEN BSP

ZSTOPFEN METRIC

■ Juntas / O-rings & captive seals / Joints / Guarnizioni

| 108



JVT

JVBSP/JVM

Racores DIN 2353

DIN 2353 Pipe fittings
Raccords à bague DIN 2353
Raccordi DIN 2353

■ Accesorios para montaje / Accessories for the assembly / Accessoires pour le montage / Accessori per assemblaggio

| 109

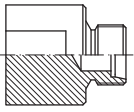

ZVOM0



Grasa

■ Válvulas antirretorno / Valves / Valves clapet antiretour / Valvole di ritegno

| 110

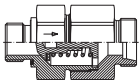

ZRHVL/ZRHVS

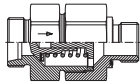

ZRHZL/ZRHZS

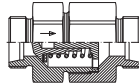

ZRHDL/ZRHDS

Abrazaderas

Clamps
Colliers
Collari fissatubo

Abrazaderas completas serie ligera / Complete clamps light serie / Colliers complets série légère / Collari fissatubo completo serie leggera

| 111



ZA40AZ

ZA41AZ

Componentes abrazaderas serie ligera / Components for clamps light serie / Composants pour colliers série légère / Componenti per collari fissatubo serie leggera

| 112



A C

ZAPIN

ZAPS

ZAVTC

ZAVTE

Dobles / paralelas / Double clamp - parallel / Colliers de fixation doubles / Collari fissatubo doppi

| 113



ZAZCFS

ZADPIN

ZADPS

AD C

ZADVTE

Componentes abrazaderas serie pesada / Components for clamps heavy serie / Composants pour colliers série lourde / Componenti per collari fissatubo serie pesante

| 114



TC/TS

AMPP C

ZAPINP

ZAPSP

ZAVTE

Tubo rígido

Rigid pipe
Tube rigide
Tubo rigido

Crimp fittings for hoses

Pipe fittings DIN 2353

Flare fittings JIC 37° / SAE Flanges

Adaptors

Welding fittings

Industrial fittings

Couplings, Ball valves and Hydraulic Components

Tubo rígido - 6 mts

Rigid pipe - 6 mts

Tube rigide - 6 mts

Tubo rigido - 6 mts



Ø OUTER Ø EXT.	Ø INNER Ø INT.	WP (bar) PRESIÓN TRABAJO (bar)	KG/M	Thickness (mm) Espesor (mm)	Part nº Referencia	€/M
6	4	490	0,125	1	ZTH0060100	13,39
8	6	368	0,175	1	ZTH0080100	15,40
10	7	441	0,318	1,5	ZTH0100150	21,93
12	9	368	0,393	1,5	ZTH0120150	24,20
14	10	420	0,600	2	ZTH0140200	33,71
15	12	294	0,506	1,5	ZTH0150150	25,44
16	12	368	0,700	2	ZTH0160200	33,07
18	15	245	0,618	1,5	ZTH0180150	30,66
20	14	441	1,275	3	ZTH0200300	57,75
22	18	267	1,000	2	ZTH0220200	46,13
25	19	353	1,650	3	ZTH0250300	75,01
28	24	210	1,302	2	ZTH0280200	59,06
30	24	294	2,028	3	ZTH0300300	92,13
35	31	168	1,653	2	ZTH0350200	*
38	30	309	3,355	4	ZTH0380400	*
42	36	210	2,930	3	ZTH0420300	*

Los precios son por metros. / Price per meter. / Les prix sont par mètre. / I prezzi si intendono al metro

Tubo rígido - 3 mts

Rigid pipe - 3 mts

Tube rigide - 3 mts

Tubo rigido - 3 mts



Ø OUTER Ø EXT.	Ø INNER Ø INT.	WP (bar) PRESIÓN TRABAJO (bar)	KG/M	Thickness (mm) Espesor (mm)	Part nº Referencia	€/M
6	4	490	0,125	1	ZTH0060100-3	13,93
8	6	368	0,175	1	ZTH0080100-3	16,02
10	7	441	0,318	1,5	ZTH0100150-3	22,81
12	9	368	0,393	1,5	ZTH0120150-3	25,17
14	10	420	0,600	2	ZTH0140200-3	35,06
15	12	294	0,506	1,5	ZTH0150150-3	26,46
16	12	368	0,700	2	ZTH0160200-3	34,39
18	15	245	0,618	1,5	ZTH0180150-3	31,89
20	14	441	1,275	3	ZTH0200300-3	60,06
22	18	267	1,000	2	ZTH0220200-3	47,98
25	19	353	1,650	3	ZTH0250300-3	78,01
28	24	210	1,302	2	ZTH0280200-3	61,42
30	24	294	2,028	3	ZTH0300300-3	95,81
35	31	168	1,653	2	ZTH0350200-3	*
38	30	309	3,355	4	ZTH0380400-3	*
42	36	210	2,930	3	ZTH0420300-3	*

Los precios son por metros. / Price per meter. / Les prix sont par mètre. / I prezzi si intendono al metro



Racores DIN 2353

DIN 2353 Pipe fittings
Raccords à bague DIN 2353
Raccordi DIN 2353

Tuercas Métricas DIN 3870

Nuts DIN 3870

Écrou DIN 3870

Dado DIN 3870

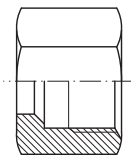

PIPE TUBO	SERIE	THREAD ROSCA	Part nº Referencia	€
4	LL	M8X1	Z MLL 4	2,44
6	LL	M10X1	Z MLL 6	2,44
8	LL	M12X1	Z MLL 8	2,84
6	L	M12X1.5	Z ML 6	2,09
8	L	M14X1.5	Z ML 8	2,31
10	L	M16X1.5	Z ML 10	2,86
12	L	M18X1.5	Z ML 12	3,31
15	L	M22X1.5	Z ML 15	4,55
18	L	M26X1.5	Z ML 18	6,92
22	L	M30X2	Z ML 22	9,13
28	L	M36X2	Z ML 28	20,17
35	L	M45X2	Z ML 35	28,54
42	L	M52X2	Z ML 42	35,96
6	S	M14X1.5	Z MS 6	2,68
8	S	M16X1.5	Z MS 8	3,02
10	S	M18X1.5	Z MS 10	3,41
12	S	M20X1.5	Z MS 12	3,91
14	S	M22X1.5	Z MS 14	6,21
16	S	M24X1.5	Z MS 16	7,12
20	S	M30X2	Z MS 20	10,89
25	S	M36X2	Z MS 25	25,67
30	S	M42X2	Z MS 30	32,71
38	S	M52X2	Z MS 38	50,14

Anillo FKM anti-fuga

FKM ring for leaking prevent

Joint FKM anti-fuite

Anello FKM anti-fuga

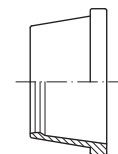

PIPE TUBO	SERIE	Part nº Referencia	€
6	L/S	VA006L	*
8	L/S	VA008L	*
10	L/S	VA010L	*
12	L/S	VA012L	*
15	L	VA015L	*
18	L	VA018L	*
22	L	VA022L	*
28	L	VA028L	*
35	L	VA035L	*
42	L	VA042L	*
14	S	VA014S	*
16	S	VA016S	*
20	S	VA020S	*
25	S	VA025S	*
30	S	VA030S	*
38	S	VA038S	*

*Ver precios en Tarifa Conducciones Hidráulicas y Neumáticas / *See prices in Hydraulic and Pneumatic Connectors' Catalogue / *Voir les prix dans le Catalogue Connectique Hydraulique et Pneumatique

Anillos de corte DIN 3861

Cutting rings DIN 3861

Bague DIN 3861

Anello DIN 3861



PIPE TUBO	SERIE	Part nº Referencia	€
4	LL	Z ACLL 4	1,84
6	LL	Z ACLL 6	1,84
8	LL	Z ACLL 8	2,05
6	L/S	Z ACL 6	1,91
8	L/S	Z ACL 8	1,97
10	L/S	Z ACL 10	2,52
12	L/S	Z ACL 12	2,63
15	L	Z ACL 15	2,89
18	L	Z ACL 18	3,15
22	L	Z ACL 22	4,20
28	L	Z ACL 28	6,30
35	L	Z ACL 35	9,45
42	L	Z ACL 42	11,03
14	S	Z ACS 14	3,29
16	S	Z ACS 16	3,57
20	S	Z ACS 20	4,20
25	S	Z ACS 25	6,30
30	S	Z ACS 30	9,45
38	S	Z ACS 38	9,98

Anillo de refuerzo

Reinforced ring

Bague de renforcement

Anello di rinforzo

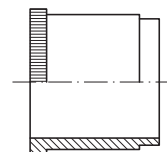

PIPE TUBO	Part nº Referencia	€
4	Z VHS 4	*
5	Z VHS 5	*
6	Z VHS 6	*
7	Z VHS 7	*
8	Z VHS 8	*
9	Z VHS 9	*
10	Z VHS 10	*
11	Z VHS 11	*
12	Z VHS 12	*
13	Z VHS 13	*
14	Z VHS 14	*
15	Z VHS 15	*
16	Z VHS 16	*
17	Z VHS 17	*
18	Z VHS 18	*
19	Z VHS 19	*
20	Z VHS 20	*
22	Z VHS 22	*
24	Z VHS 24	*
25	Z VHS 25	*
31	Z VHS 31	*
33	Z VHS 33	*
38	Z VHS 38	*

Racores DIN 2353

DIN 2353 Pipe fittings
Raccords à bague DIN 2353
Raccordi DIN 2353

Crimp fittings for hoses

Pipe fittings DIN 2353

Flare fittings JIC 37° / SAE Flanges

Adaptors

Welding fittings

Industrial fittings

Couplings, Ball valves and Hydraulic Components

Racor unión recta tubo - tubo

Straight coupling

Raccord union double

Raccordo intermedio diritto

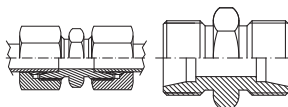

PIPE TUBO	SERIE	Part nº Referencia	€	Part Nº STA Referencia STA	€
4	LL	Z DLL 4	*		*
6	LL	Z DLL 6	*		*
8	LL	Z DLL 8	*		*
6	L	Z DL 6	11,91	Z STA DL 6	5,09
8	L	Z DL 8	11,93	Z STA DL 8	6,48
10	L	Z DL 10	14,19	Z STA DL 10	7,48
12	L	Z DL 12	15,88	Z STA DL 12	7,49
15	L	Z DL 15	22,58	Z STA DL 15	10,76
18	L	Z DL 18	27,46	Z STA DL 18	12,16
22	L	Z DL 22	38,34	Z STA DL 22	18,45
28	L	Z DL 28	64,05	Z STA DL 28	31,50
35	L	Z DL 35	93,12	Z STA DL 35	43,05
42	L	Z DL 42	140,18	Z STA DL 42	67,20
6	S	Z DS 6	15,89	Z STA DS 6	8,40
8	S	Z DS 8	17,26	Z STA DS 8	7,61
10	S	Z DS 10	18,92	Z STA DS 10	10,11
12	S	Z DS 12	22,05	Z STA DS 12	13,58
14	S	Z DS 14	29,40	Z STA DS 14	16,30
16	S	Z DS 16	27,11	Z STA DS 16	13,09
20	S	Z DS 20	46,55	Z STA DS 20	21,45
25	S	Z DS 25	78,62	Z STA DS 25	36,75
30	S	Z DS 30	103,82	Z STA DS 30	47,25
38	S	Z DS 38	150,15	Z STA DS 38	61,95

Racor unión en codo tubo - tubo

Equal elbow coupling

Raccord coude égal

Raccordo intermedio a 90°

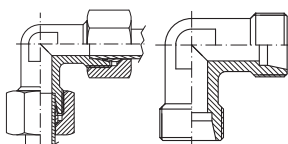

PIPE TUBO	SERIE	Part nº Referencia	€	Part Nº STA Referencia STA	€
4	LL	Z ELL 4	*		*
6	LL	Z ELL 6	*		*
8	LL	Z ELL 8	*		*
6	L	Z EL 6	19,26	Z STA EL 6	13,45
8	L	Z EL 8	19,56	Z STA EL 8	15,59
10	L	Z EL 10	23,54	Z STA EL 10	18,33
12	L	Z EL 12	26,07	Z STA EL 12	18,95
15	L	Z EL 15	39,87	Z STA EL 15	26,25
18	L	Z EL 18	51,52	Z STA EL 18	35,70
22	L	Z EL 22	68,55	Z STA EL 22	48,19
28	L	Z EL 28	118,68	Z STA EL 28	77,70
35	L	Z EL 35	176,55	Z STA EL 35	122,72
42	L	Z EL 42	248,38	Z STA EL 42	190,05
6	S	Z ES 6	21,52	Z STA ES 6	17,63
8	S	Z ES 8	27,21	Z STA ES 8	19,20
10	S	Z ES 10	29,44	Z STA ES 10	19,95
12	S	Z ES 12	31,97	Z STA ES 12	23,10
14	S	Z ES 14	40,95	Z STA ES 14	29,40
16	S	Z ES 16	50,91	Z STA ES 16	34,27
20	S	Z ES 20	75,51	Z STA ES 20	51,91
25	S	Z ES 25	120,95	Z STA ES 25	76,98
30	S	Z ES 30	166,12	Z STA ES 30	112,84
38	S	Z ES 38	257,45	Z STA ES 38	171,15

Racor unión recta en reducción tubo - tubo

Straight reducing coupling

Raccord union double en réduction

Raccordo di riduzione

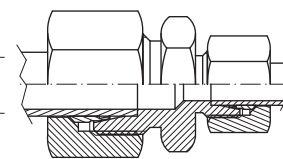

PIPE TUBO	SERIE	Part nº Referencia	€	
8	6	L	Z DL 8-6	16,62
10	6	L	Z DL 10-6	19,52
10	8	L	Z DL 10-8	17,99
12	6	L	Z DL 12-6	18,27
12	8	L	Z DL 12-8	19,76
12	10	L	Z DL 12-10	19,01
15	6	L	Z DL 15-6	28,56
15	8	L	Z DL 15-8	25,83
15	10	L	Z DL 15-10	25,94
15	12	L	Z DL 15-12	24,57
18	8	L	Z DL 18-8	35,07
18	10	L	Z DL 18-10	34,55
18	12	L	Z DL 18-12	35,07
18	15	L	Z DL 18-15	36,86
22	12	L	Z DL 22-12	46,62
22	15	L	Z DL 22-15	46,10
22	18	L	Z DL 22-18	48,83
28	22	L	Z DL 28-22	80,33
35	28	L	Z DL 35-28	105,63
42	28	L	Z DL 42-28	134,40
42	35	L	Z DL 42-35	136,92
8	6	S	Z DS 8-6	21,92
10	6	S	Z DS 10-6	22,12
10	8	S	Z DS 10-8	23,56
12	6	S	Z DS 12-6	26,19
12	8	S	Z DS 12-8	25,17
12	10	S	Z DS 12-10	26,18
14	10	S	Z DS 14-10	33,39
16	10	S	Z DS 16-10	36,02
16	12	S	Z DS 16-12	35,28
16	14	S	Z DS 16-14	41,09
20	12	S	Z DS 20-12	49,27
20	14	S	Z DS 20-14	57,02
20	16	S	Z DS 20-16	55,57
25	16	S	Z DS 25-16	85,58
25	20	S	Z DS 25-20	90,83
30	20	S	Z DS 30-20	120,75
30	25	S	Z DS 30-25	125,16
38	25	S	Z DS 38-25	155,40
38	30	S	Z DS 38-30	157,50

Racores DIN 2353

DIN 2353 Pipe fittings
Raccords à bague DIN 2353
Raccordi DIN 2353

Racor unión en T tubo - tubo

Equal Tee

Raccord Té égal

Raccordo intermedio a T

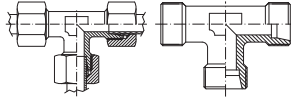

PIPE TUBO	SERIE	Part nº Referencia	€	Part Nº STA Referencia STA	€
4	LL	Z TLL 4	*		*
6	LL	Z TLL 6	*		*
8	LL	Z TLL 8	*		*
6	L	Z TL 6	24,95	Z STA TL 6	16,86
8	L	Z TL 8	28,64	Z STA TL 8	19,45
10	L	Z TL 10	31,47	Z STA TL 10	20,85
12	L	Z TL 12	35,00	Z STA TL 12	22,44
15	L	Z TL 15	49,88	Z STA TL 15	33,50
18	L	Z TL 18	67,47	Z STA TL 18	44,10
22	L	Z TL 22	96,64	Z STA TL 22	62,90
28	L	Z TL 28	151,10	Z STA TL 28	105,97
35	L	Z TL 35	249,10	Z STA TL 35	178,50
42	L	Z TL 42	330,75	Z STA TL 42	236,25
6	S	Z TS 6	29,39	Z STA TS 6	21,60
8	S	Z TS 8	30,63	Z STA TS 8	22,29
10	S	Z TS 10	35,05	Z STA TS 10	22,39
12	S	Z TS 12	42,10	Z STA TS 12	29,60
14	S	Z TS 14	75,64	Z STA TS 14	46,27
16	S	Z TS 16	70,88	Z STA TS 16	45,92
20	S	Z TS 20	93,57	Z STA TS 20	62,09
25	S	Z TS 25	166,95	Z STA TS 25	104,67
30	S	Z TS 30	252,83	Z STA TS 30	159,40
38	S	Z TS 38	357,42	Z STA TS 38	222,89

Racor unión en cruz tubo - tubo

Equal cross

Raccord croix égale

Raccordo intermedio a croce

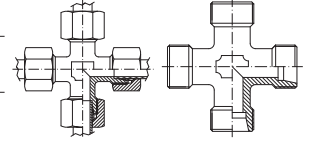

PIPE TUBO	SERIE	Part nº Referencia	€	Part Nº STA Referencia STA	€
6	L	Z KVL 6	53,55	Z STA KVL 6	37,54
8	L	Z KVL 8	71,40	Z STA KVL 8	54,28
10	L	Z KVL 10	99,42	Z STA KVL 10	77,92
12	L	Z KVL 12	86,36	Z STA KVL 12	62,62
15	L	Z KVL 15	139,06	Z STA KVL 15	111,28
18	L	Z KVL 18	148,71		*
22	L	Z KVL 22	185,46		*
28	L	Z KVL 28	241,50		*
35	L	Z KVL 35	583,64		*
42	L	Z KVL 42	567,76		*
6	S	Z KVS 6	61,95	Z STA KVS 6	44,25
8	S	Z KVS 8	102,84	Z STA KVS 8	82,85
10	S	Z KVS 10	90,56	Z STA KVS 10	66,84
12	S	Z KVS 12	110,91	Z STA KVS 12	84,79
14	S	Z KVS 14	161,92	Z STA KVS 14	126,19
16	S	Z KVS 16	163,01	Z STA KVS 16	129,65
20	S	Z KVS 20	197,21	Z STA KVS 20	139,38
25	S	Z KVS 25	273,00		*
30	S	Z KVS 30	383,83		*
38	S	Z KVS 38	573,25		*

Racores DIN 2353

DIN 2353 Pipe fittings
Raccords à bague DIN 2353
Raccordi DIN 2353

Crimp fittings for hoses

Pipe fittings DIN 2353

Flare fittings JIC37° / SAE Flanges

Adaptors

Welding fittings

Industrial fittings

Couplings, Ball valves and Hydraulic Components

Racor recto rosca cilíndrica BSP

Straight male stud coupling BSP cylindrical

Raccord union simple gaz cylindrique mâle

Raccordo di estremità diritto BSP

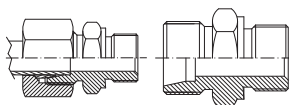

T.	S.	THREAD ROSCA	Part nº Referencia	€	Part Nº STA Referencia STA	€
6	L	1/8" BSP	Z AL 6 R 1/8	7,81	Z STA AL 6 R 1/8	5,25
6	L	1/4" BSP	Z AL 6 R 1/4	11,45	Z STA AL 6 R 1/4	9,45
6	L	3/8" BSP	Z AL 6 R 3/8	15,12		*
8	L	1/8" BSP	Z AL 8 R 1/8	11,10	Z STA AL 8 R 1/8	8,40
8	L	1/4" BSP	Z AL 8 R 1/4	10,24	Z STA AL 8 R 1/4	6,30
8	L	3/8" BSP	Z AL 8 R 3/8	13,38	Z STA AL 8 R 3/8	11,55
8	L	1/2" BSP	Z AL 8 R 1/2	18,16		*
10	L	1/8" BSP	Z AL 10 R 1/8	12,80	Z STA AL 10 R 1/8	8,10
10	L	1/4" BSP	Z AL 10 R 1/4	11,29	Z STA AL 10 R 1/4	6,83
10	L	3/8" BSP	Z AL 10 R 3/8	14,79	Z STA AL 10 R 3/8	11,55
10	L	1/2" BSP	Z AL 10 R 1/2	18,38	Z STA AL 10 R 1/2	15,23
12	L	1/4" BSP	Z AL 12 R 1/4	14,28	Z STA AL 12 R 1/4	9,98
12	L	3/8" BSP	Z AL 12 R 3/8	12,42	Z STA AL 12 R 3/8	9,42
12	L	1/2" BSP	Z AL 12 R 1/2	16,61	Z STA AL 12 R 1/2	12,29
15	L	3/8" BSP	Z AL 15 R 3/8	18,11	Z STA AL 15 R 3/8	12,60
15	L	1/2" BSP	Z AL 15 R 1/2	18,18	Z STA AL 15 R 1/2	13,13
15	L	3/4" BSP	Z AL 15 R 3/4	27,68		*
18	L	1/2" BSP	Z AL 18 R 1/2	21,64	Z STA AL 18 R 1/2	14,96
18	L	3/4" BSP	Z AL 18 R 3/4	30,35	Z STA AL 18 R 3/4	22,05
22	L	3/8" BSP	Z AL 22 R 3/8	30,49		*
22	L	1/2" BSP	Z AL 22 R 1/2	31,90	Z STA AL 22 R 1/2	21,29
22	L	3/4" BSP	Z AL 22 R 3/4	28,59	Z STA AL 22 R 3/4	18,95
22	L	1" BSP	Z AL 22 R 1	44,07	Z STA AL 22 R 1	30,69
28	L	3/4" BSP	Z AL 28 R 3/4	48,03	Z STA AL 28 R 3/4	28,35
28	L	1" BSP	Z AL 28 R 1	47,39	Z STA AL 28 R 1	28,95
35	L	1" 1/4 BSP	Z AL 35 R 1 1/4	81,64	Z STA AL 35 R 1 1/4	45,15
35	L	1" 1/2 BSP	Z AL 35 R 1 1/2	104,32		*
42	L	1" 1/2 BSP	Z AL 42 R 1 1/2	105,39	Z STA AL 42 R 1 1/2	57,68
6	S	1/4" BSP	Z AS 6 R 1/4	13,13	Z STA AS 6 R 1/4	9,45
6	S	3/8" BSP	Z AS 6 R 3/8	18,38		*
8	S	1/4" BSP	Z AS 8 R 1/4	12,50	Z STA AS 8 R 1/4	8,60
8	S	3/8" BSP	Z AS 8 R 3/8	17,52		*
8	S	1/2" BSP	Z AS 8 R 1/2	24,94		*
10	S	1/4" BSP	Z AS 10 R 1/4	14,77	Z STA AS 10 R 1/4	9,45
10	S	3/8" BSP	Z AS 10 R 3/8	16,40	Z STA AS 10 R 3/8	10,42
10	S	1/2" BSP	Z AS 10 R 1/2	22,58	Z STA AS 10 R 1/2	17,85
12	S	1/4" BSP	Z AS 12 R 1/4	19,04	Z STA AS 12 R 1/4	15,22
12	S	3/8" BSP	Z AS 12 R 3/8	16,80	Z STA AS 12 R 3/8	12,86
12	S	1/2" BSP	Z AS 12 R 1/2	20,54	Z STA AS 12 R 1/2	15,41
14	S	3/8" BSP	Z AS 14 R 3/8	24,26		*
14	S	1/2" BSP	Z AS 14 R 1/2	24,91	Z STA AS 14 R 1/2	18,90
16	S	3/8" BSP	Z AS 16 R 3/8	25,20	Z STA AS 16 R 3/8	16,28
16	S	1/2" BSP	Z AS 16 R 1/2	25,10	Z STA AS 16 R 1/2	15,75
16	S	3/4" BSP	Z AS 16 R 3/4	33,72	Z STA AS 16 R 3/4	23,15
20	S	1/2" BSP	Z AS 20 R 1/2	34,65	Z STA AS 20 R 1/2	22,05
20	S	3/4" BSP	Z AS 20 R 3/4	36,75	Z STA AS 20 R 3/4	23,17
20	S	1" BSP	Z AS 20 R 1	53,53	Z STA AS 20 R 1	42,93
25	S	3/4" BSP	Z AS 25 R 3/4	57,75	Z STA AS 25 R 3/4	35,77
25	S	1" BSP	Z AS 25 R 1	59,59	Z STA AS 25 R 1	36,33
30	S	1" BSP	Z AS 30 R 1	77,80	Z STA AS 30 R 1	44,29
30	S	1" 1/2 BSP	Z AS 30 R 1 1/2	131,17		*
38	S	1" 1/4 BSP	Z AS 38 R 1 1/4	123,80	Z STA AS 38 R 1 1/4	66,87
38	S	1" 1/2 BSP	Z AS 38 R 1 1/2	118,20	Z STA AS 38 R 1 1/2	72,52

Racor recto rosca cilíndrica BSP con junta

Straight male stud coupling BSP cylindrical with captive seal

Raccord union simple mâle gaz cylindrique avec joint plat

Raccordo di estremità diritto BSP con guarnizione

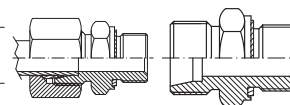

T.	S.	THREAD ROSCA	Part nº Referencia	€	Part Nº STA Referencia STA	€
6	L	1/8" BSP	Z AL 6 R 1/8WD	9,35	Z STA AL 6 R 1/8WD	7,84
6	L	1/4" BSP	Z AL 6 R 1/4WD	12,60	Z STA AL 6 R 1/4WD	10,50
6	L	3/8" BSP	Z AL 6 R 3/8WD	15,65		*
8	L	1/8" BSP	Z AL 8 R 1/8WD	13,23	Z STA AL 8 R 1/8WD	9,39
8	L	1/4" BSP	Z AL 8 R 1/4WD	11,10	Z STA AL 8 R 1/4WD	8,03
8	L	3/8" BSP	Z AL 8 R 3/8WD	14,37	Z STA AL 8 R 3/8WD	12,71
8	L	1/2" BSP	Z AL 8 R 1/2WD	18,90		*
10	L	1/8" BSP	Z AL 10 R 1/8WD	14,60	Z STA AL 10 R 1/8WD	10,32
10	L	1/4" BSP	Z AL 10 R 1/4WD	11,81	Z STA AL 10 R 1/4WD	8,35
10	L	3/8" BSP	Z AL 10 R 3/8WD	16,10	Z STA AL 10 R 3/8WD	13,47
10	L	1/2" BSP	Z AL 10 R 1/2WD	19,50	Z STA AL 10 R 1/2WD	16,81
12	L	1/4" BSP	Z AL 12 R 1/4WD	16,28	Z STA AL 12 R 1/4WD	12,60
12	L	3/8" BSP	Z AL 12 R 3/8WD	14,60	Z STA AL 12 R 3/8WD	11,30
12	L	1/2" BSP	Z AL 12 R 1/2WD	18,93	Z STA AL 12 R 1/2WD	15,28
15	L	3/8" BSP	Z AL 15 R 3/8WD	20,79	Z STA AL 15 R 3/8WD	15,75
15	L	1/2" BSP	Z AL 15 R 1/2WD	19,43	Z STA AL 15 R 1/2WD	12,60
15	L	3/4" BSP	Z AL 15 R 3/4WD	29,40		*
18	L	3/8" BSP	Z AL 18 R 3/8WD	27,39	Z STA AL 18 R 3/8WD	*
18	L	1/2" BSP	Z AL 18 R 1/2WD	22,03	Z STA AL 18 R 1/2WD	14,77
18	L	3/4" BSP	Z AL 18 R 3/4WD	31,29	Z STA AL 18 R 3/4WD	22,05
22	L	1/2" BSP	Z AL 22 R 1/2WD	35,16	Z STA AL 22 R 1/2WD	23,63
22	L	3/4" BSP	Z AL 22 R 3/4WD	28,53	Z STA AL 22 R 3/4WD	18,95
22	L	1" BSP	Z AL 22 R 1WD	45,15	Z STA AL 22 R 1WD	36,99
28	L	3/4" BSP	Z AL 28 R 3/4WD	53,55	Z STA AL 28 R 3/4WD	35,34
28	L	1" BSP	Z AL 28 R 1WD	48,72	Z STA AL 28 R 1WD	29,99
28	L	1" 1/4 BSP	Z AL 28 R 1 1/4WD	86,63	Z STA AL 28 R 1 1/4WD	*
35	L	1" BSP	Z AL 35 R 1WD	75,30	Z STA AL 35 R 1WD	42,10
35	L	1" 1/4 BSP	Z AL 35 R 1 1/4WD	79,50	Z STA AL 35 R 1 1/4WD	51,45
42	L	1" 1/2 BSP	Z AL 42 R 1 1/2WD	98,00	Z STA AL 42 R 1 1/2WD	65,00
6	S	1/4" BSP	Z AS 6 R 1/4WD	15,86	Z STA AS 6 R 1/4WD	12,60
8	S	1/4" BSP	Z AS 8 R 1/4WD	14,70	Z STA AS 8 R 1/4WD	11,55
8	S	3/8" BSP	Z AS 8 R 3/8WD	18,11	Z STA AS 8 R 3/8WD	15,46
8	S	1/2" BSP	Z AS 8 R 1/2WD	21,99		*
10	S	1/4" BSP	Z AS 10 R 1/4WD	16,85	Z STA AS 10 R 1/4WD	13,27
10	S	3/8" BSP	Z AS 10 R 3/8WD	17,33	Z STA AS 10 R 3/8WD	13,13
10	S	1/2" BSP	Z AS 10 R 1/2WD	23,76	Z STA AS 10 R 1/2WD	19,95
12	S	1/4" BSP	Z AS 12 R 1/4WD	18,38	Z STA AS 12 R 1/4WD	13,65
12	S	3/8" BSP	Z AS 12 R 3/8WD	17,52	Z STA AS 12 R 3/8WD	11,55
12	S	1/2" BSP	Z AS 12 R 1/2WD	22,05	Z STA AS 12 R 1/2WD	17,85
14	S	3/8" BSP	Z AS 14 R 3/8WD	24,94	Z STA AS 14 R 3/8WD	19,87
14	S	1/2" BSP	Z AS 14 R 1/2WD	24,35	Z STA AS 14 R 1/2WD	18,90
16	S	1/4" BSP	Z AS 16 R 1/4WD	*	Z STA AS 16 R 1/4WD	*
16	S	3/8" BSP	Z AS 16 R 3/8WD	27,50	Z STA AS 16 R 3/8WD	17,85
16	S	1/2" BSP	Z AS 16 R 1/2WD	26,25	Z STA AS 16 R 1/2WD	17,33
16	S	3/4" BSP	Z AS 16 R 3/4WD	30,98	Z STA AS 16 R 3/4WD	22,05
16	S	1" BSP	Z AS 16 R 1WD	*	Z STA AS 16 R 1WD	*
20	S	1/2" BSP	Z AS 20 R 1/2WD	34,11	Z STA AS 20 R 1/2WD	23,44
20	S	3/4" BSP	Z AS 20 R 3/4WD	34,59	Z STA AS 20 R 3/4WD	23,44
25	S	3/4" BSP	Z AS 25 R 3/4WD	61,30	Z STA AS 25 R 3/4WD	47,74
25	S	1" BSP	Z AS 25 R 1WD	61,43	Z STA AS 25 R 1WD	47,85
25	S	1" 1/4 BSP	Z AS 25 R 1 1/4WD	98,26		*
30	S	3/4" BSP	Z AS 30 R 3/4WD	*	Z STA AS 30 R 3/4WD	*
30	S	1" BSP	Z AS 30 R 1WD	77,52	Z STA AS 30 R 1WD	41,78
30	S	1" 1/4 BSP	Z AS 30 R 1 1/4WD	92,37	Z STA AS 30 R 1 1/4WD	65,19
30	S	1" 1/2 BSP	Z AS 30 R 1 1/2WD	144,38		*
38	S	1" 1/4 BSP	Z AS 38 R 1 1/4WD	117,60	Z STA AS 38 R 1 1/4WD	73,22
38	S	1" 1/2 BSP	Z AS 38 R 1 1/2WD	116,59	Z STA AS 38 R 1 1/2WD	72,21

Racores DIN 2353

DIN 2353 Pipe fittings
Raccords à bague DIN 2353
Raccordi DIN 2353

Racor recto rosca cónica NPT

Straight male stud coupling NPT

Raccord union simple mâle NPT

Raccordo di estremità diritto NPT

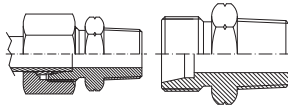

T.	S.	THREAD ROSCA	Part nº Referencia	€	Part Nº STA Referencia STA	€
6	L	1/8"NPT	Z AKL 6 1/8 NPT	11,66	Z STA AKL 6 1/8 NPT	8,93
6	L	1/4"NPT	Z AKL 6 1/4 NPT	11,66	Z STA AKL 6 1/4 NPT	9,35
6	L	3/8"NPT	Z AKL 6 3/8 NPT	14,73		*
6	L	1/2"NPT	Z AKL 6 1/2 NPT	21,90	Z STA AKL 6 1/2 NPT	*
8	L	1/8"NPT	Z AKL 8 1/8 NPT	12,10	Z STA AKL 8 1/8 NPT	9,17
8	L	1/4"NPT	Z AKL 8 1/4 NPT	12,73	Z STA AKL 8 1/4 NPT	9,45
8	L	3/8"NPT	Z AKL 8 3/8 NPT	13,43		*
8	L	1/2"NPT	Z AKL 8 1/2 NPT	19,90		*
10	L	1/4"NPT	Z AKL 10 1/4 NPT	13,11	Z STA AKL 10 1/4 NPT	10,08
10	L	3/8"NPT	Z AKL 10 3/8 NPT	16,52		*
10	L	1/2"NPT	Z AKL 10 1/2 NPT	19,80		*
10	L	3/4"NPT	Z AKL 10 3/4 NPT	*	Z STA AKL 10 3/4 NPT	*
12	L	1/4"NPT	Z AKL 12 1/4 NPT	15,68	Z STA AKL 12 1/4 NPT	13,30
12	L	3/8"NPT	Z AKL 12 3/8 NPT	17,75	Z STA AKL 12 3/8 NPT	13,03
12	L	1/2"NPT	Z AKL 12 1/2 NPT	18,38	Z STA AKL 12 1/2 NPT	14,07
15	L	3/8"NPT	Z AKL 15 3/8 NPT	24,26		*
15	L	1/2"NPT	Z AKL 15 1/2 NPT	21,92	Z STA AKL 15 1/2 NPT	17,33
15	L	3/4"NPT	Z AKL 15 3/4 NPT	27,90	Z STA AKL 15 3/4 NPT	*
18	L	1/2"NPT	Z AKL 18 1/2 NPT	27,40	Z STA AKL 18 1/2 NPT	21,95
18	L	3/4"NPT	Z AKL 18 3/4 NPT	34,65	Z STA AKL 18 3/4 NPT	26,25
18	L	1"NPT	Z AKL 18 1 NPT	*	Z STA AKL 18 1 NPT	*
22	L	1/2"NPT	Z AKL 22 1/2 NPT	37,80	Z STA AKL 22 1/2 NPT	*
22	L	3/4"NPT	Z AKL 22 3/4 NPT	36,50		*
28	L	1"NPT	Z AKL 28 1 NPT	63,00		*
35	L	1"1/4NPT	Z AKL 35 1 1/4 NPT	80,85		*
42	L	1"1/2NPT	Z AKL 42 1 1/2 NPT	110,25		*
6	S	1/8"NPT	Z AKS 6 1/8 NPT	16,09		*
6	S	1/4"NPT	Z AKS 6 1/4 NPT	14,90	Z STA AKS 6 1/4 NPT	10,82
6	S	3/8"NPT	Z AKS 6 3/8 NPT	19,95		*
8	S	1/4"NPT	Z AKS 8 1/4 NPT	16,91	Z STA AKS 8 1/4 NPT	12,46
8	S	3/8"NPT	Z AKS 8 3/8 NPT	22,05		*
8	S	1/2"NPT	Z AKS 8 1/2 NPT	22,58		*
10	S	1/4"NPT	Z AKS 10 1/4 NPT	19,95		*
10	S	3/8"NPT	Z AKS 10 3/8 NPT	20,69		*
10	S	1/2"NPT	Z AKS 10 1/2 NPT	20,81		*
12	S	1/4"NPT	Z AKS 12 1/4 NPT	21,53		*
12	S	3/8"NPT	Z AKS 12 3/8 NPT	19,85		*
12	S	1/2"NPT	Z AKS 12 1/2 NPT	18,80		*
14	S	1/2"NPT	Z AKS 14 1/2 NPT	27,30	Z STA AKS 14 1/2 NPT	20,55
16	S	1/2"NPT	Z AKS 16 1/2 NPT	31,08	Z STA AKS 16 1/2 NPT	24,73
16	S	3/4"NPT	Z AKS 16 3/4 NPT	30,98		*
16	S	1"NPT	Z AKS 16 1 NPT	*	Z STA AKS 16 1 NPT	*
20	S	1/2"NPT	Z AKS 20 1/2 NPT	43,05		*
20	S	3/4"NPT	Z AKS 20 3/4 NPT	42,00	Z STA AKS 20 3/4 NPT	32,17
20	S	1"NPT	Z AKS 20 1 NPT	54,86		*
25	S	3/4"NPT	Z AKS 25 3/4 NPT	74,55		*
25	S	1"NPT	Z AKS 25 1 NPT	65,10	Z STA AKS 25 1 NPT	41,80
30	S	1"NPT	Z AKS 30 1 NPT	119,19		*
30	S	1"1/4NPT	Z AKS 30 1 1/4 NPT	90,30		*
38	S	1"1/2NPT	Z AKS 38 1 1/2 NPT	126,00		*

Racor recto rosca cónica BSPT

Straight male stud coupling BSPT

Raccord union simple mâle conique

Raccordo di estremità diritto BSP conico

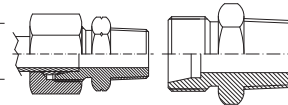

T.	S.	THREAD ROSCA	Part nº Referencia	€	Part Nº STA Referencia STA	€
6	LL	1/8" BSPT	Z AKLL 6 R 1/8	12,13		*
8	LL	1/8" BSPT	Z AKLL 8 R 1/8	14,44		*
6	L	1/8" BSPT	Z AKL 6 R 1/8	11,45	Z STA AKL 6 R 1/8	8,40
6	L	1/4" BSPT	Z AKL 6 R 1/4	11,98	Z STA AKL 6 R 1/4	8,40
8	L	1/8" BSPT	Z AKL 8 R 1/8	14,30		*
8	L	1/4" BSPT	Z AKL 8 R 1/4	11,03	Z STA AKL 8 R 1/4	7,98
8	L	3/8" BSPT	Z AKL 8 R 3/8	15,90		*
10	L	1/4" BSPT	Z AKL 10 R 1/4	11,62	Z STA AKL 10 R 1/4	8,76
10	L	3/8" BSPT	Z AKL 10 R 3/8	13,18	Z STA AKL 10 R 3/8	9,94
10	L	1/2" BSPT	Z AKL 10 R 1/2	19,85		*
12	L	1/4" BSPT	Z AKL 12 R 1/4	15,23	Z STA AKL 12 R 1/4	12,32
12	L	3/8" BSPT	Z AKL 12 R 3/8	12,89	Z STA AKL 12 R 3/8	10,43
12	L	1/2" BSPT	Z AKL 12 R 1/2	17,64	Z STA AKL 12 R 1/2	13,44
15	L	3/8" BSPT	Z AKL 15 R 3/8	21,80		*
15	L	1/2" BSPT	Z AKL 15 R 1/2	20,48	Z STA AKL 15 R 1/2	15,23
18	L	1/2" BSPT	Z AKL 18 R 1/2	23,89	Z STA AKL 18 R 1/2	16,81
22	L	3/4" BSPT	Z AKL 22 R 3/4	31,22	Z STA AKL 22 R 3/4	22,63
28	L	1" BSPT	Z AKL 28 R 1	54,99	Z STA AKL 28 R 1	40,95
35	L	1"1/4 BSPT	Z AKL 35 R 1 1/4	75,60		*
42	L	1"1/4 BSPT	Z AKL 42 R 1 1/4	105,61		*
6	S	1/4" BSPT	Z AKS 6 R 1/4	13,75		*
8	S	1/4" BSPT	Z AKS 8 R 1/4	15,32		*
10	S	3/8" BSPT	Z AKS 10 R 3/8	31,69		*
14	S	1/2" BSPT	Z AKS 14 R 1/2	49,73		*
16	S	1/2" BSPT	Z AKS 16 R 1/2	24,18	Z STA AKS 16 R 1/2	17,83
20	S	3/4" BSPT	Z AKS 20 R 3/4	50,00		*
25	S	1" BSPT	Z AKS 25 R 1	68,06	Z STA AKS 25 R 1	37,81
30	S	1"1/4 BSPT	Z AKS 30 R 1 1/4	139,98		*

Racor recto rosca UNF

Straight male stud coupling UNF

Raccord union simple mâle UNF

Raccordo di estremità diritto UNF

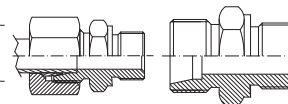

T.	S.	THREAD ROSCA	Part nº Referencia	€	Part Nº STA Referencia STA	€
8	L	7/16 UNF	Z AL 8 7/16 UNF	*	Z STA AL 8 7/16 UNF	*
10	L	7/16 UNF	Z AL 10 7/16 UNF	*	Z STA AL 10 7/16 UNF	*
12	L	9/16 UNF	Z AL 12 9/16 UNF	*	Z STA AL 12 9/16 UNF	*
15	L	3/4 UNF	Z AL 15 3/4 UNF	*	Z STA AL 15 3/4 UNF	*
18	L	7/8 UNF	Z AL 18 7/8 UNF	*	Z STA AL 18 7/8 UNF	*
22	L	1 1/16 UNF	Z AL 22 1 1/16 UNF	*	Z STA AL 22 1 1/16 UNF	*
28	L	1 5/16 UNF	Z AL 28 1 5/16 UNF	*	Z STA AL 28 1 5/16 UNF	*
35	L	1 5/8 UNF	Z AL 35 1 5/8 UNF	*	Z STA AL 35 1 5/8 UNF	*
8	S	7/16 UNF	Z AS 8 7/16 UNF	*	Z STA AS 8 7/16 UNF	*
10	S	9/16 UNF	Z AS 10 9/16 UNF	*	Z STA AS 10 9/16 UNF	*
12	S	9/16 UNF	Z AS 12 9/16 UNF	*	Z STA AS 12 9/16 UNF	*
16	S	3/4 UNF	Z AS 16 3/4 UNF	*	Z STA AS 16 3/4 UNF	*
20	S	7/8 UNF	Z AS 20 7/8 UNF	*	Z STA AS 20 7/8 UNF	*
25	S	1 5/16 UNF	Z AS 25 1 5/16 UNF	*	Z STA AS 25 1 5/16 UNF	*
30	S	1 5/16 UNF	Z AS 30 1 5/16 UNF	*	Z STA AS 30 1 5/16 UNF	*
38	S	1 5/8 UNF	Z AS 38 1 5/8 UNF	*	Z STA AS 38 1 5/8 UNF	*

Racores DIN 2353

DIN 2353 Pipe fittings
Raccords à bague DIN 2353
Raccordi DIN 2353

Crimp fittings for hoses

Pipe fittings DIN 2353

Flare fittings JIC 37° / SAE Flanges

Adaptors

Welding fittings

Industrial fittings

Couplings, Ball valves and Hydraulic Components

Racor recto rosca cilíndrica Métrica con junta

Straight male stud coupling Metric cylindrical with captive seal

Raccord union simple mâle cylindrique Métrique avec joint plat

Raccordo di estremità diritto Metrico con guarnizione

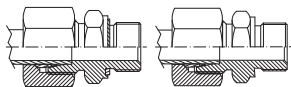

T.	S.	THREAD ROSCA	Part nº Referencia	€	Part Nº Referencia	€
6	L	M10x1	Z AL 6 M 10X1 WD	10,64	Z AL 6 M 10X1	9,47
8	L	M12x1.5	Z AL 8 M 12X1.5 WD	13,13	Z AL 8 M 12X1.5	11,75
10	L	M14x1.5	Z AL 10 M 12X1.5 WD	17,27		*
10	L	M14x1.5	Z AL 10 M 14X1.5 WD	17,33	Z AL 10 M 14X1.5	12,80
10	L	M16x1.5	Z AL 10 M 16X1.5 WD	19,64		*
12	L	M16x1.5	Z AL 12 M 16X1.5 WD	18,64	Z AL 12 M 16X1.5	13,23
12	L	M18x1.5	Z AL 12 M 18X1.5 WD	19,43		*
12	L	M22x1.5	Z AL 12 M 22X1.5 WD	25,73		*
15	L	M18x1.5	Z AL 15 M 18X1.5 WD	27,20	Z AL 15 M 18X1.5	18,77
18	L	M22x1.5	Z AL 18 M 22X1.5 WD	30,89	Z AL 18 M 22X1.5	24,15
22	L	M26x1.5	Z AL 22 M 26X1.5 WD	36,54	Z AL 22 M 26X1.5	32,55
28	L	M33x2	Z AL 28 M 33X2 WD	62,46		*
35	L	M42x2	Z AL 35 M 42X2 WD	95,39		*
42	L	M48x2	Z AL 42 M 48X2 WD	129,46	Z AL 42 M 48X2	*
6	S	M12x1.5	Z AS 6 M 12X1.5 WD	18,19		*
6	S	M14x1.5	Z AS 6 M 14X1.5 WD	18,74		*
8	S	M14x1.5	Z AS 8 M 14X1.5 WD	19,19	Z AS 8 M 14X1.5	16,19
10	S	M16x1.5	Z AS 10 M 16X1.5 WD	21,83		*
12	S	M14x1.5	Z AS 12 M 14X1.5 WD	23,85		*
12	S	M18x1.5	Z AS 12 M 18X1.5 WD	24,14	Z AS 12 M 18X1.5	21,11
14	S	M20x1.5	Z AS 14 M 20X1.5 WD	33,22		*
16	S	M22x1.5	Z AS 16 M 22X1.5 WD	30,66		*
20	S	M27x2	Z AS 20 M 27X2 WD	43,61	Z AS 20 M 27X2	38,22
25	S	M33x2	Z AS 25 M 33X2 WD	63,06		*
30	S	M42x2	Z AS 30 M 42X2 WD	91,51	Z AS 30 M 42X2	*
38	S	M48x2	Z AS 38 M 48X2 WD	144,43	Z AS 38 M 48X2	129,41

Ref.sin WD hasta fin de existencias.Salvo indicación expresa del cliente se suministrará con o sin junta según disponibilidad / Ref.without WD until end of stock.Unless otherwise indicated by the client, we will supply with or without o'ring depending on availability / Ref.sans WD jusqu'à fin du stock.Sauf indication expresse du client, sera fourni avec ou sans o'ring selon disponibilité

Racor recto rosca cónica Métrica

Straight male stud coupling Metric tapered

Raccord union simple mâle Métrique conique

Raccordo di estremità diritto Metrico conico

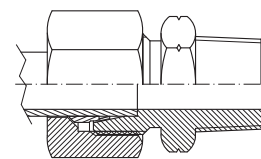

PIPE TUBO	SERIE	THREAD ROSCA	Part nº Referencia	€
6	LL	M10X1	Z AKLL 6 M10X1	12,60
6	L	M10X1	Z AKL 6 M 10X1	13,06
8	L	M12X1.5	Z AKL 8 M 12X1.5	16,26
10	L	M14X1.5	Z AKL 10 M 14X1.5	19,74
12	L	M16X1.5	Z AKL 12 M 16X1.5	19,95
15	L	M18X1.5	Z AKL 15 M 18X1.5	27,30
18	L	M22X1.5	Z AKL 18 M 22X1.5	35,70
22	L	M26X1.5	Z AKL 22 M 26X1.5	32,55

Racores DIN 2353

DIN 2353 Pipe fittings
Raccords à bague DIN 2353
Raccordi DIN 2353

Racor en codo rosca cónica BSPT

Male stud elbow BSPT

Raccord union coude mâle gaz conique

Raccordo di estremità a 90° BSP conico

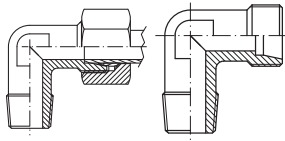

T.	S.	THREAD ROSCA	Part n° Referencia	€	Part N° STA Referencia STA	€
6	LL	1/8" BSPT	Z CKLL 6 R 1/8	23,21		*
6	L	1/8" BSPT	Z CKL 6 R 1/8	17,08	Z STA CKL 6 R 1/8	12,98
6	L	1/4" BSPT	Z CKL 6 R 1/4	18,00	Z STA CKL 6 R 1/4	13,89
8	L	1/8" BSPT	Z CKL 8 R 1/8	20,74	Z STA CKL 8 R 1/8	18,48
8	L	1/4" BSPT	Z CKL 8 R 1/4	18,95	Z STA CKL 8 R 1/4	16,88
8	L	3/8" BSPT	Z CKL 8 R 3/8	24,94	Z STA CKL 8 R 3/8	21,32
8	L	1/2" BSPT	Z CKL 8 R 1/2	31,61	Z STA CKL 8 R 1/2	27,33
10	L	1/8" BSPT	Z CKL 10 R 1/8	29,31	Z STA CKL 10 R 1/8	28,80
10	L	1/4" BSPT	Z CKL 10 R 1/4	20,45	Z STA CKL 10 R 1/4	17,88
10	L	3/8" BSPT	Z CKL 10 R 3/8	19,72	Z STA CKL 10 R 3/8	18,24
10	L	1/2" BSPT	Z CKL 10 R 1/2	26,90	Z STA CKL 10 R 1/2	21,52
12	L	1/4" BSPT	Z CKL 12 R 1/4	25,44	Z STA CKL 12 R 1/4	20,74
12	L	3/8" BSPT	Z CKL 12 R 3/8	25,04	Z STA CKL 12 R 3/8	22,27
12	L	1/2" BSPT	Z CKL 12 R 1/2	27,33	Z STA CKL 12 R 1/2	26,25
15	L	3/8" BSPT	Z CKL 15 R 3/8	39,62		*
15	L	1/2" BSPT	Z CKL 15 R 1/2	37,42	Z STA CKL 15 R 1/2	25,20
18	L	1/2" BSPT	Z CKL 18 R 1/2	47,25	Z STA CKL 18 R 1/2	36,75
22	L	3/4" BSPT	Z CKL 22 R 3/4	66,36	Z STA CKL 22 R 3/4	58,20
28	L	1" BSPT	Z CKL 28 R 1	177,56		*
35	L	1"1/4 BSPT	Z CKL 35 R 1 1/4	236,57		*
42	L	1"1/2 BSPT	Z CKL 42 R 1 1/2 *	265,39		*
6	S	1/4" BSPT	Z CKS 6 R 1/4	21,07	Z STA CKS 6 R 1/4	16,67
8	S	1/4" BSPT	Z CKS 8 R 1/4	24,12	Z STA CKS 8 R 1/4	20,29
8	S	3/8" BSPT	Z CKS 8 R 3/8 *	24,12		*
8	S	1/2" BSPT	Z CKS 8 R 1/2	28,77		*
10	S	1/4" BSPT	Z CKS 10 R 1/4	36,62	Z STA CKS 10 R 1/4	30,91
10	S	3/8" BSPT	Z CKS 10 R 3/8	28,82	Z STA CKS 10 R 3/8	20,53
10	S	1/2" BSPT	Z CKS 10 R 1/2 *	27,62		*
12	S	3/8" BSPT	Z CKS 12 R 3/8	31,56	Z STA CKS 12 R 3/8	26,99
14	S	1/2" BSPT	Z CKS 14 R 1/2	51,19	Z STA CKS 14 R 1/2	36,88
16	S	1/2" BSPT	Z CKS 16 R 1/2	53,81	Z STA CKS 16 R 1/2	40,28
20	S	3/4" BSPT	Z CKS 20 R 3/4	82,24	Z STA CKS 20 R 3/4	114,90
25	S	1" BSPT	Z CKS 25 R 1	147,45	Z STA CKS 25 R 1	124,15
30	S	1"1/4 BSPT	Z CKS 30 R 1 1/4	265,71		*
38	S	1"1/2 BSPT	Z CKS 38 R 1 1/2	388,56		*

*Hasta fin de existencias. / *Until end of stock. / *Jusqu'à la fin du stock. / *Fino ad esaurimento scorta.

Racor en codo orientable BSP

90° Adjustable male stud elbow BSP

Coude orientable mâle BSP

Raccordo a 90° orientabile maschio BSP

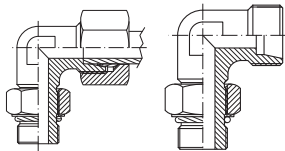

T.	S.	THREAD ROSCA	Part n° Referencia	€	Part N° STA Referencia STA	€
6	L	1/8" BSP	Z WEE 6L R 1/8	21,75	Z STA WEE 6L R 1/8	18,44
8	L	1/4" BSP	Z WEE 8L R 1/4	30,43	Z STA WEE 8L R 1/4	26,15
10	L	1/4" BSP	Z WEE 10L R 1/4	35,77	Z STA WEE 10L R 1/4	30,39
12	L	3/8" BSP	Z WEE 12L R 3/8	48,36	Z STA WEE 12L R 3/8	42,42
15	L	1/2" BSP	Z WEE 15L R 1/2	87,87	Z STA WEE 15L R 1/2	80,43
18	L	1/2" BSP	Z WEE 18L R 1/2	91,82	Z STA WEE 18L R 1/2	81,75
22	L	3/4" BSP	Z WEE 22L R 3/4	113,37	Z STA WEE 22L R 3/4	100,04
16	S	1/2" BSP	Z WEE 16S R 1/2	78,60	Z STA WEE 16S R 1/2	67,90
20	S	3/4" BSP	Z WEE 20S R 3/4	118,89	Z STA WEE 20S R 3/4	103,80
25	S	1" BSP	Z WEE 25S R 1	200,91	Z STA WEE 25S R 1	168,94

Racor en codo rosca cónica NPT

Male stud elbow NPT

Raccord union coude mâle NPT

Raccordo di estremità a 90° NPT

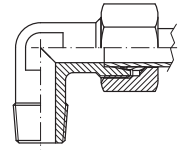

PIPE TUBO	SERIE	THREAD ROSCA	Part n° Referencia	€
6	L	1/8" NPT	Z CKL 6 1/8 NPT	18,74
6	L	1/4" NPT	Z CKL 6 1/4 NPT	18,74
8	L	1/4" NPT	Z CKL 8 1/4 NPT	18,95
10	L	1/4" NPT	Z CKL 10 1/4 NPT	22,31
12	L	1/4" NPT	Z CKL 12 1/4 NPT	24,99
12	L	3/8" NPT	Z CKL 12 3/8 NPT	28,29
12	L	1/2" NPT	Z CKL 12 1/2 NPT	27,80
15	L	1/2" NPT	Z CKL 15 1/2 NPT	36,75
15	L	1" NPT	Z CKL 15 1 NPT	*
18	L	1/2" NPT	Z CKL 18 1/2 NPT	51,45
22	L	3/4" NPT	Z CKL 22 3/4 NPT	68,45
28	L	1" NPT	Z CKL 28 1 NPT	107,50
35	L	1"1/4 NPT	Z CKL 35 1 1/4 NPT	*
42	L	1"1/2 NPT	Z CKL 42 1 1/2 NPT	*
6	S	1/4" NPT	Z CKS 6 1/4 NPT	21,88
8	S	1/4" NPT	Z CKS 8 1/4 NPT	22,33
10	S	3/8" NPT	Z CKS 10 3/8 NPT	26,38
12	S	3/8" NPT	Z CKS 12 3/8 NPT	33,60
12	S	1/2" NPT	Z CKS 12 1/2 NPT	34,24
14	S	1/2" NPT	Z CKS 14 1/2 NPT	51,45
16	S	1/2" NPT	Z CKS 16 1/2 NPT	50,40
20	S	3/4" NPT	Z CKS 20 3/4 NPT	68,25
25	S	1" NPT	Z CKS 25 1 NPT	135,65
30	S	1"1/4 NPT	Z CKS 30 1 1/4 NPT	*
38	S	1"1/2 NPT	Z CKS 38 1 1/2 NPT	*

Racor en codo rosca cónica Métrica

Male stud elbow metrical tapered

Raccord équerre mâle métrique

Raccordo di estremità a 90° Metrico conico

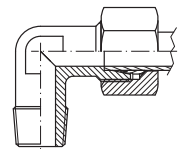

PIPE TUBO	SERIE	THREAD ROSCA	Part n° Referencia	€
6	L	M10X1	Z CKL 6 M 10X1	22,14
8	L	M12X1.5	Z CKL 8 M 12X1.5	28,54
10	L	M14X1.5	Z CKL 10 M 14X1.5	30,74
12	L	M16X1.5	Z CKL 12 M 16X1.5	33,01
15	L	M18X1.5	Z CKL 15 M 18X1.5	49,83
18	L	M22X1.5	Z CKL 18 M 22X1.5	54,72
6	S	M12X1.5	Z CKS 6 M 12X1.5	22,71
8	S	M14X1.5	Z CKS 8 M 14X1.5	38,26
10	S	M16X1.5	Z CKS 10 M 16X1.5	39,57
12	S	M18X1.5	Z CKS 12 M 18X1.5	43,80
14	S	M20X1.5	Z CKS 14 M 20X1.5	43,44
16	S	M22X1.5	Z CKS 16 M 22X1.5	96,96

Racores DIN 2353

DIN 2353 Pipe fittings
Raccords à bague DIN 2353
Raccordi DIN 2353

Crimp fittings for hoses

Pipe fittings DIN 2353

Flare fittings JIC37° / SAE Flanges

Adaptors

Welding fittings

Industrial fittings

Couplings, Ball valves and Hydraulic Components

Racor en T rosca cónica BSPT

Male stud branch TEE BSPT tapered

Raccord TÉ mâle gaz conique au centre

Raccordo di estremità a T BSP conico

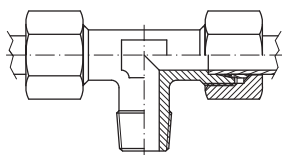

PIPE TUBO	SERIE	THREAD ROSCA	Part nº Referencia	€
6	L	1/8" BSPT	Z FKL 6 R 1/8	34,99
8	L	1/4" BSPT	Z FKL 8 R 1/4	33,74
10	L	1/4" BSPT	Z FKL 10 R 1/4	40,95
12	L	3/8" BSPT	Z FKL 12 R 3/8	46,20
15	L	1/2" BSPT	Z FKL 15 R 1/2	63,00
18	L	1/2" BSPT	Z FKL 18 R 1/2	79,80
6	S	1/4" BSPT	Z FKS 6 R 1/4	41,02
8	S	1/4" BSPT	Z FKS 8 R 1/4	46,20
10	S	3/8" BSPT	Z FKS 10 R 3/8	47,25
12	S	3/8" BSPT	Z FKS 12 R 3/8	60,90
14	S	1/2" BSPT	Z FKS 14 R 1/2	73,50
16	S	1/4" BSPT	Z FKS 16 1/2	86,10

Racor en T rosca cónica Métrica

Male stud branch TEE Metric tapered

Raccord TÉ mâle Métrique au centre

Raccordo di estremità a T Metrico conico

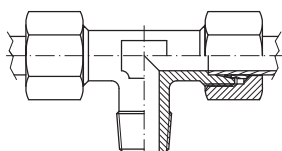

PIPE TUBO	SERIE	THREAD ROSCA	Part nº Referencia	€
6	L	M10X1	Z FKL 6 M 10X1	35,85
8	L	M12X1.5	Z FKL 8 M 12X1.5	36,81
10	L	M14X1.5	Z FKL 10 M 14X1.5	35,47
12	L	M16X1.5	Z FKL 12 M 16X1.5	44,80
15	L	M18X1.5	Z FKL 15 M 18X1.5	10,85
18	L	M22X1.5	Z FKL 18 M 22X1.5	85,07
6	S	M12X1.5	Z FKS 6 M 12X1.5	31,67
8	S	M14X1.5	Z FKS 8 M 14X1.5	36,47
10	S	M16X1.5	Z FKS 10 M 16X1.5	41,20
12	S	M18X1.5	Z FKS 12 M 18X1.5	46,75
14	S	M20X1.5	Z FKS 14 M 20X1.5	13,43
16	S	M22X1.5	Z FKS 16 M 22X1.5	97,48

Racor en L rosca cónica BSPT

Male stud barrel TEE BSPT tapered

Raccord TÉ mâle gaz conique latéral

Raccordo di estremità a L BSP conico

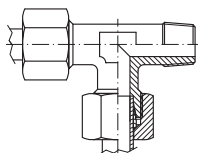

PIPE TUBO	SERIE	THREAD ROSCA	Part nº Referencia	€
6	L	1/8" BSPT	Z LKL 6 R 1/8	36,75
8	L	1/4" BSPT	Z LKL 8 R 1/4	38,85
10	L	1/4" BSPT	Z LKL 10 R 1/4	40,95
12	L	3/8" BSPT	Z LKL 12 R 3/8	44,10
15	L	1/2" BSPT	Z LKL 15 R 1/2	61,95
18	L	1/2" BSPT	Z LKL 18 R 1/2	102,05
6	S	1/4" BSPT	Z LKS 6 R 1/4	39,97
8	S	1/4" BSPT	Z LKS 8 R 1/4	44,24
10	S	3/8" BSPT	Z LKS 10 R 3/8	47,25
12	S	3/8" BSPT	Z LKS 12 R 3/8	55,52
14	S	1/2" BSPT	Z LKS 14 R 1/2	68,25
16	S	1/2" BSPT	Z LKS 16 R 1/2	86,10

Racor en T rosca cónica NPT

Male stud branch TEE NPT

Raccord TÉ mâle NPT au centre

Raccordo di estremità a T NPT

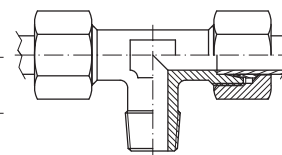

PIPE TUBO	SERIE	THREAD ROSCA	Part nº Referencia	€
6	L	1/8" NPT	Z FKL 6 R 1/8 NPT	36,75
8	L	1/4" NPT	Z FKL 8 R 1/4 NPT	36,23
10	L	1/4" NPT	Z FKL 10 R 1/4 NPT	45,81
12	L	3/8" NPT	Z FKL 12 R 3/8 NPT	51,45
18	L	1/2" NPT	Z FKL 18 R 1/2 NPT	100,80
22	L	3/4" NPT	Z FKL 22 R 3/4 NPT	128,10
28	L	1" NPT	Z FKL 28 R 1 NPT	170,10
35	L	1 1/4" NPT	Z FKL 35 R 1 1/4 NPT	325,50
42	L	1 1/2" NPT	Z FKL 42 R 1 1/2 NPT	336,00
6	S	1/4" NPT	Z FKS 6 R 1/4 NPT	36,75
10	S	3/8" NPT	Z FKS 10 R 3/8 NPT	48,30
12	S	3/8" NPT	Z FKS 12 R 3/8 NPT	57,75
14	S	1/2" NPT	Z FKS 14 R 1/2 NPT	60,90
16	S	1/2" NPT	Z FKS 16 R 1/2 NPT	98,70
20	S	3/4" NPT	Z FKS 20 R 3/4 NPT	126,00
25	S	1" NPT	Z FKS 25 R 1 NPT	182,70
30	S	1 1/4" NPT	Z FKS 30 R 1 1/4 NPT	294,00
38	S	1 1/2" NPT	Z FKS 38 R 1 1/2 NPT	451,50

Racor en L rosca cónica Métrica

Male stud barrel TEE Metric tapered

Raccord Té mâle Métrique latéral

Raccordo di estremità a L Metrico conico

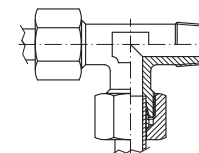

PIPE TUBO	SERIE	THREAD ROSCA	Part nº Referencia	€
6	L	M10X1	Z LKL 6 M 10X1	37,66
8	L	M12X1.5	Z LKL 8 M 12X1.5	39,46
10	L	M14X1.5	Z LKL 10 M 14X1.5	42,91
12	L	M16X1.5	Z LKL 12 M 16X1.5	51,58
15	L	M18X1.5	Z LKL 15 M 18X1.5	62,64
18	L	M22X1.5	Z LKL 18 M 22X1.5	106,99
6	S	M12X1.5	Z LKS 6 M 12X1.5	43,71
8	S	M14X1.5	Z LKS 8 M 14X1.5	50,33
10	S	M16X1.5	Z LKS 10 M 16X1.5	56,85
12	S	M18X1.5	Z LKS 12 M 18X1.5	64,51
14	S	M20X1.5	Z LKS 14 M 20X1.5	92,67
16	S	M22X1.5	Z LKS 16 M 22X1.5	134,52

Racores DIN 2353

DIN 2353 Pipe fittings
Raccords à bague DIN 2353
Raccordi DIN 2353

Racor de reducción con TL Métrica (serie ligera)

Standpipe reducer with taper (light series)

Raccord union simple femelle tournante
Métrique (série légère)

Raccordo di riduzione con cono 24° (serie leggera)

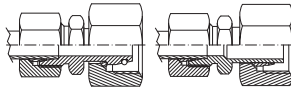

T.	S.	Part nº Referencia	€	Part nº Referencia	€
8	6	L Z KORL 8-6 TLM	25,10	Z KORL 8-6 CTA	23,84
10	6	L Z KORL 10-6 TLM	23,89	Z KORL 10-6 CTA	22,69
12	6	L Z KORL 12-6 TLM	25,10		*
12	8	L Z KORL 12-8 TLM	25,14	Z KORL 12-8 CTA	23,88
12	10	L Z KORL 12-10 TLM	26,97	Z KORL 12-10 CTA	25,63
15	6	L Z KORL 15-6 TLM	32,89	Z KORL 15-6 CTA	31,24
15	8	L Z KORL 15-8 TLM	31,40	Z KORL 15-8 CTA	29,83
15	10	L Z KORL 15-10 TLM	31,45	Z KORL 15-10 CTA	29,88
15	12	L Z KORL 15-12 TLM	29,51	Z KORL 15-12 CTA	28,03
18	8	L Z KORL 18-8 TLM	36,65	Z KORL 18-8 CTA	34,81
18	10	L Z KORL 18-10 TLM	36,62	Z KORL 18-10 CTA	34,79
18	12	L Z KORL 18-12 TLM	37,70	Z KORL 18-12 CTA	35,81
18	15	L Z KORL 18-15 TLM	39,80	Z KORL 18-15 CTA	37,81
22	10	L Z KORL 22-10 TLM	41,90		*
22	12	L Z KORL 22-12 TLM	42,74	Z KORL 22-12 CTA	40,60
22	15	L Z KORL 22-15 TLM	45,68	Z KORL 22-15 CTA	43,39
22	18	L Z KORL 22-18 TLM	51,35	Z KORL 22-18 CTA	49,80
28	10	L Z KORL 28-10 TLM	56,96		*
28	12	L Z KORL 28-12 TLM	58,12	Z KORL 28-12 CTA	55,21
28	15	L Z KORL 28-15 TLM	60,19		*
28	18	L Z KORL 28-18 TLM	60,80		*
28	22	L Z KORL 28-22 TLM	62,00		*
35	12	L Z KORL 35-12 TLM	83,90	Z KORL 35-12 CTA	83,55
35	22	L Z KORL 35-22 TLM	93,03		*
35	28	L Z KORL 35-28 TLM	95,55	Z KORL 35-28 CTA	90,77
42	22	L Z KORL 42-22 TLM	115,40	Z KORL 42-22 CTA	109,63
42	28	L Z KORL 42-28 TLM	119,60	Z KORL 42-28 CTA	113,62
42	35	L Z KORL 42-35 TLM	124,85	Z KORL 42-35 CTA	118,60

Ref.CTA hasta fin de existencias.Salvo indicación expresa del cliente se suministrará TLM o CTA según disponibilidad / Ref.CTA until end of stock.Unless otherwise indicated by the client, we will supply TLM or CTA depending on availability / Ref.CTA jusqu'à fin du stock.Sauf indication expresse du client, sera fourni TLM ou CTA selon disponibilité

Racor de reducción con TL Métrica (serie pesada)

Standpipe reducer with taper (heavy series)

Raccord union simple femelle tournante
Métrique (série lourde)

Raccordo di riduzione con cono 24° (serie pesante)

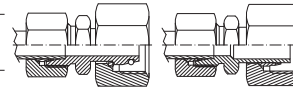

T.	S.	Part nº Referencia	€	Part nº Referencia	€
8	6	S Z KORS 8-6 TLM	27,17	Z KORS 8-6 CTA	25,82
10	6	S Z KORS 10-6 TLM	29,21	Z KORS 10-6 CTA	27,75
10	8	S Z KORS 10-8 TLM	28,25	Z KORS 10-8 CTA	26,83
12	6	S Z KORS 12-6 TLM	26,91	Z KORS 12-6 CTA	25,57
12	8	S Z KORS 12-8 TLM	29,30	Z KORS 12-8 CTA	27,83
12	10	S Z KORS 12-10 TLM	31,40	Z KORS 12-10 CTA	29,83
14	10	S Z KORS 14-10 TLM	35,57	Z KORS 14-10 CTA	33,80
14	12	S Z KORS 14-12 TLM	35,37		*
16	6	S Z KORS 16-6 TLM	40,04	Z KORS 16-6 CTA	38,03
16	8	S Z KORS 16-8 TLM	37,70	Z KORS 16-8 CTA	35,81
16	10	S Z KORS 16-10 TLM	38,01		*
16	12	S Z KORS 16-12 TLM	40,43	Z KORS 16-12 CTA	38,40
16	14	S Z KORS 16-14 TLM	41,90		*
20	8	S Z KORS 20-8 TLM	49,25	Z KORS 20-8 CTA	46,78
20	10	S Z KORS 20-10 TLM	49,14	Z KORS 20-10 CTA	46,68
20	12	S Z KORS 20-12 TLM	48,72	Z KORS 20-12 CTA	46,28
20	14	S Z KORS 20-14 TLM	50,60		*
20	16	S Z KORS 20-16 TLM	54,50	Z KORS 20-16 CTA	51,77
25	12	S Z KORS 25-12 TLM	63,30	Z KORS 25-12 CTA	60,14
25	16	S Z KORS 25-16 TLM	68,78	Z KORS 25-16 CTA	65,34
25	20	S Z KORS 25-20 TLM	76,55	Z KORS 25-20 CTA	72,72
30	16	S Z KORS 30-16 TLM	109,10		*
30	20	S Z KORS 30-20 TLM	110,15	Z KORS 30-20 CTA	104,64
30	25	S Z KORS 30-25 TLM	116,45	Z KORS 30-25 CTA	110,62
38	20	S Z KORS 38-20 TLM	139,55		*
38	25	S Z KORS 38-25 TLM	150,05	Z KORS 38-25 CTA	*
38	30	S Z KORS 38-30 TLM	159,50		*

Ref.CTA hasta fin de existencias.Salvo indicación expresa del cliente se suministrará TLM o CTA según disponibilidad / Ref. CTA until end of stock.Unless otherwise indicated by the client, we will supply TLM or CTA depending on availability / Ref.CTA jusqu'à fin du stock.Sauf indication expresse du client, sera fourni TLM ou CTA selon disponibilité

Racores DIN 2353

DIN 2353 Pipe fittings
Raccords à bague DIN 2353
Raccordi DIN 2353

Crimp fittings for hoses

Pipe fittings DIN 2353

Flare fittings JIC 37° / SAE Flanges

Adaptors

Welding fittings

Industrial fittings

Couplings, Ball valves and Hydraulic Components

Reducción con rosca M-HF BSP con junta tórica

Male-female reducing adaptor BSP cylindrical with o'ring

Raccord réduction mâle gaz-fem gaz avec joint torique

Adattatore di riduzione filettato maschio - femmina BSP con guarnizione

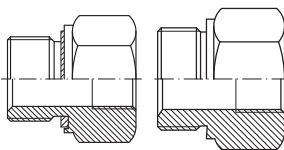

THREAD ROSCA		Part nº Referencia	€	Part Nº Referencia	€
M 1/8" BSP	F 1/4" BSP	Z RI-R 1/8 R 1/4WD	14,18		*
M 1/4" BSP	F 1/8" BSP	Z RI-R 1/4 R 1/8WD	13,97		*
M 1/4" BSP	F 3/8" BSP	Z RI-R 1/4 R 3/8WD	17,64		*
M 1/4" BSP	F 1/2" BSP	Z RI-R 1/4 R 1/2WD	20,90	Z RI-R 1/4-1/2	19,85
M 3/8" BSP	F 1/8" BSP	Z RI-R 3/8 R 1/8WD	15,54	Z RI-R 3/8-1/8	*
M 3/8" BSP	F 1/4" BSP	Z RI-R 3/8 R 1/4WD	16,75	Z RI-R 3/8-1/4	15,91
M 3/8" BSP	F 1/2" BSP	Z RI-R 3/8 R 1/2WD	18,85	Z RI-R 3/8-1/2	17,91
M 3/8" BSP	F 3/4" BSP	Z RI-R 3/8 R 3/4WD	27,04		*
M 1/2" BSP	F 1/8" BSP	Z RI-R 1/2 R 1/8WD	19,43	Z RI-R 1/2-1/8	18,45
M 1/2" BSP	F 1/4" BSP	Z RI-R 1/2 R 1/4WD	18,17	Z RI-R 1/2-1/4	17,26
M 1/2" BSP	F 3/8" BSP	Z RI-R 1/2 R 3/8WD	20,79	Z RI-R 1/2-3/8	19,75
M 1/2" BSP	F 3/4" BSP	Z RI-R 1/2 R 3/4WD	29,14		*
M 3/4" BSP	F 1/4" BSP	Z RI-R 3/4 R 1/4WD	26,36	Z RI-R 3/4-1/4	25,04
M 3/4" BSP	F 3/8" BSP	Z RI-R 3/4 R 3/8WD	27,20	Z RI-R 3/4-3/8	25,84
M 3/4" BSP	F 1/2" BSP	Z RI-R 3/4 R 1/2WD	28,09	Z RI-R 3/4-1/2	26,68
M 3/4" BSP	F 1" BSP	Z RI-R 3/4 R 1WD	47,97	Z RI-R 3/4-1	45,58
M 1" BSP	F 1/4" BSP	Z RI-R 1 R 1/4WD	30,56	Z RI-R 1-1/4	29,03
M 1" BSP	F 3/8" BSP	Z RI-R 1 R 3/8WD	30,66	Z RI-R 1-3/8	29,13
M 1" BSP	F 1/2" BSP	Z RI-R 1 R 1/2WD	33,29	Z RI-R 1-1/2	31,62
M 1" BSP	F 3/4" BSP	Z RI-R 1 R 3/4WD	45,05	Z RI-R 1-3/4	42,79
M 1" BSP	F 1" BSP	Z RI-R 1 R 1 1/4WD	101,85		*
M 1" 1/4 BSP	F 1/2" BSP	Z RI-R 1 1/4 R 1/2WD	52,08	Z RI-R 1 1/4-1/2	49,48
M 1" 1/4 BSP	F 3/4" BSP	Z RI-R 1 1/4 R 3/4WD	58,17	Z RI-R 1 1/4-3/4	55,26
M 1" 1/4 BSP	F 1" BSP	Z RI-R 1 1/4 R 1WD	74,76	Z RI-R 1 1/4-1	71,02
M 1" 1/4 BSP	F 1" 1/2 BSP	Z RI-R 1 1/4 R 1 1/2WD	120,43	Z RI-R 1 1/4-1 1/2	103,79
M 1" 1/2 BSP	F 1/2" BSP	Z RI-R 1 1/2 R 1/2WD	72,45		*
M 1" 1/2 BSP	F 3/4" BSP	Z RI-R 1 1/2 R 3/4WD	69,30		*
M 1" 1/2 BSP	F 1" BSP	Z RI-R 1 1/2 R 1WD	66,15		*
M 1" 1/2 BSP	F 1" 1/4 BSP	Z RI-R 1 1/2 R 1 1/4WD	101,75	Z RI-R 1 1/2-1 1/4	96,66
M 1" 1/2 BSP	F 2" BSP	Z RI-R 1 1/2 R 2WD	138,91	Z RI-R 1 1/2-2	129,82
M 2" BSP	F 1" 1/2 BSP	Z RI-R 2 R 1 1/2WD	159,67	Z RI-R 2-1 1/2	152,07

Ref.sin WD hasta fin de existencias.Salvo indicación expresa del cliente se suministrará con o sin junta según disponibilidad / Ref. without WD until end of stock.Unless otherwise indicated by the client, we will supply with or without o'ring depending on availability / Ref.sans WD jusqu'à fin du stock.Sauf indication expresse du client, sera fourni avec ou sans o'ring selon disponibilité

Racores DIN 2353

DIN 2353 Pipe fittings
Raccords à bague DIN 2353
Raccordi DIN 2353

Racor en codo regulable con tuerca y anillo

Adjustable stud elbow with nut and ring

Raccord coude orientable tube lisse équipé

Raccordo orientabile a 90° con dado e anello

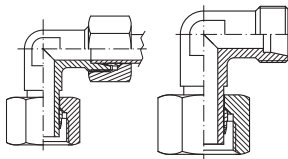

PIPE TUBO	SERIE	Part n° Referencia	€	Part N° STA Referencia STA	€
6	L	Z EEL 6 CTA	20,73	Z STA EEL 6 CTA	17,96
8	L	Z EEL 8 CTA	21,15	Z STA EEL 8 CTA	17,82
10	L	Z EEL 10 CTA	26,10	Z STA EEL 10 CTA	23,93
12	L	Z EEL 12 CTA	30,55	Z STA EEL 12 CTA	26,46
15	L	Z EEL 15 CTA	45,89	Z STA EEL 15 CTA	40,46
18	L	Z EEL 18 CTA	50,43	Z STA EEL 18 CTA	45,20
22	L	Z EEL 22 CTA	99,20	Z STA EEL 22 CTA	91,04
28	L	Z EEL 28 CTA	143,24	Z STA EEL 28 CTA	132,83
35	L	Z EEL 35 CTA	172,45	Z STA EEL 35 CTA	144,79
42	L	Z EEL 42 CTA	274,32	Z STA EEL 42 CTA	236,19
6	S	Z EES 6 CTA	22,15	Z STA EES 6 CTA	18,43
8	S	Z EES 8 CTA	23,92	Z STA EES 8 CTA	20,61
10	S	Z EES 10 CTA	26,25	Z STA EES 10 CTA	22,41
12	S	Z EES 12 CTA	33,35	Z STA EES 12 CTA	29,96
14	S	Z EES 14 CTA	39,16	Z STA EES 14 CTA	34,56
16	S	Z EES 16 CTA	49,45	Z STA EES 16 CTA	45,23
20	S	Z EES 20 CTA	95,79	Z STA EES 20 CTA	86,27
25	S	Z EES 25 CTA	149,62	Z STA EES 25 CTA	126,32
30	S	Z EES 30 CTA	192,71	Z STA EES 30 CTA	165,53
38	S	Z EES 38 CTA	333,63	Z STA EES 38 CTA	289,25

Racor en codo regulable TL Métrica

Adjustable stud elbow with o'ring

Raccord coude orientable Métrique avec o'ring

Raccordo orientabile a 90° con o'ring

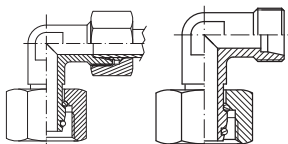

PIPE TUBO	SERIE	Part n° Referencia	€	Part N° STA Referencia STA	€
6	L	Z EEL 6 TLM	23,89	Z STA EEL 6 TLM	20,95
8	L	Z EEL 8 TLM	24,18	Z STA EEL 8 TLM	21,06
10	L	Z EEL 10 TLM	29,61	Z STA EEL 10 TLM	26,05
12	L	Z EEL 12 TLM	34,06	Z STA EEL 12 TLM	29,97
15	L	Z EEL 15 TLM	44,72	Z STA EEL 15 TLM	39,29
18	L	Z EEL 18 TLM	63,63	Z STA EEL 18 TLM	56,22
22	L	Z EEL 22 TLM	80,53	Z STA EEL 22 TLM	66,87
28	L	Z EEL 28 TLM	130,10	Z STA EEL 28 TLM	113,07
35	L	Z EEL 35 TLM	217,11	Z STA EEL 35 TLM	174,41
42	L	Z EEL 42 TLM	292,85	Z STA EEL 42 TLM	271,39
6	S	Z EES 6 TLM	29,85	Z STA EES 6 TLM	25,77
8	S	Z EES 8 TLM	30,72	Z STA EES 8 TLM	26,27
10	S	Z EES 10 TLM	35,53	Z STA EES 10 TLM	31,58
12	S	Z EES 12 TLM	40,57	Z STA EES 12 TLM	36,00
14	S	Z EES 14 TLM	52,36	Z STA EES 14 TLM	44,49
16	S	Z EES 16 TLM	58,32	Z STA EES 16 TLM	51,97
20	S	Z EES 20 TLM	82,47	Z STA EES 20 TLM	70,57
25	S	Z EES 25 TLM	151,50	Z STA EES 25 TLM	123,17
30	S	Z EES 30 TLM	196,25	Z STA EES 30 TLM	180,38
38	S	Z EES 38 TLM	323,28	Z STA EES 38 TLM	278,10

Racor en T regulable TL Métrica

Adjustable stud branch TEE with o'ring

Raccord TÉ orientable Métrique avec o'ring

Raccordo orientabile a T con o'ring

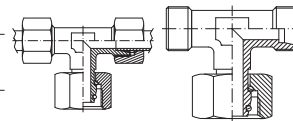

PIPE TUBO	SERIE	Part n° Referencia	€	Part N° STA Referencia STA	€
6	L	Z TEL 6 TLM	30,61	Z STA TEL 6 TLM	24,72
8	L	Z TEL 8 TLM	33,91	Z STA TEL 8 TLM	27,68
10	L	Z TEL 10 TLM	36,80	Z STA TEL 10 TLM	29,69
12	L	Z TEL 12 TLM	41,67	Z STA TEL 12 TLM	33,48
15	L	Z TEL 15 TLM	80,04	Z STA TEL 15 TLM	59,19
18	L	Z TEL 18 TLM	109,40	Z STA TEL 18 TLM	86,33
22	L	Z TEL 22 TLM	119,60	Z STA TEL 22 TLM	103,27
28	L	Z TEL 28 TLM	204,42	Z STA TEL 28 TLM	168,00
35	L	Z TEL 35 TLM	300,43	Z STA TEL 35 TLM	245,11
42	L	Z TEL 42 TLM	402,05	Z STA TEL 42 TLM	325,79
6	S	Z TES 6 TLM	37,48	Z STA TES 6 TLM	29,31
8	S	Z TES 8 TLM	41,20	Z STA TES 8 TLM	32,31
10	S	Z TES 10 TLM	45,12	Z STA TES 10 TLM	37,23
12	S	Z TES 12 TLM	55,62	Z STA TES 12 TLM	46,49
14	S	Z TES 14 TLM	87,05	Z STA TES 14 TLM	73,54
16	S	Z TES 16 TLM	101,75	Z STA TES 16 TLM	89,05
20	S	Z TES 20 TLM	133,25	Z STA TES 20 TLM	117,07
25	S	Z TES 25 TLM	205,46	Z STA TES 25 TLM	164,87
30	S	Z TES 30 TLM	294,95	Z STA TES 30 TLM	240,59
38	S	Z TES 38 TLM	411,60	Z STA TES 38 TLM	322,84

Racor en L regulable TL Métrica

Adjustable stud barrel TEE with o'ring

Raccord L orientable renversé Métrique avec o'ring

Raccordo orientabile a L con o'ring

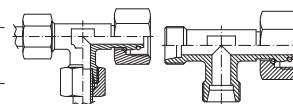

T.	S.	THREAD ROSCA	Part n° Referencia	€	Part N° STA Referencia STA	€
6	L	M12X1.5	Z LEL 6 TLM	29,37	Z STA LEL 6 TLM	23,48
8	L	M14X1.5	Z LEL 8 TLM	36,94	Z STA LEL 8 TLM	30,71
10	L	M16X1.5	Z LEL 10 TLM	42,44	Z STA LEL 10 TLM	35,33
12	L	M18X1.5	Z LEL 12 TLM	51,09	Z STA LEL 12 TLM	42,90
15	L	M22X1.5	Z LEL 15 TLM	68,40	Z STA LEL 15 TLM	57,55
18	L	M26X1.5	Z LEL 18 TLM	98,81	Z STA LEL 18 TLM	83,98
22	L	M30X2	Z LEL 22 TLM	140,07	Z STA LEL 22 TLM	123,74
28	L	M36X2	Z LEL 28 TLM	202,55	Z STA LEL 28 TLM	166,13
35	L	M45X2	Z LEL 35 TLM	307,55	Z STA LEL 35 TLM	252,23
42	L	M52X2	Z LEL 42 TLM	429,45	Z STA LEL 42 TLM	353,19
6	S	M14X1.5	Z LES 6 TLM	31,30	Z STA LES 6 TLM	23,13
8	S	M16X1.5	Z LES 8 TLM	39,89	Z STA LES 8 TLM	31,00
10	S	M18X1.5	Z LES 10 TLM	52,38	Z STA LES 10 TLM	44,48
12	S	M20X1.5	Z LES 12 TLM	49,44	Z STA LES 12 TLM	40,31
14	S	M22X1.5	Z LES 14 TLM	80,75	Z STA LES 14 TLM	67,24
16	S	M24X1.5	Z LES 16 TLM	97,55	Z STA LES 16 TLM	84,85
20	S	M30X2	Z LES 20 TLM	131,78	Z STA LES 20 TLM	112,11
25	S	M36X2	Z LES 25 TLM	213,05	Z STA LES 25 TLM	177,85
30	S	M42X2	Z LES 30 TLM	318,05	Z STA LES 30 TLM	263,69
38	S	M52X2	Z LES 38 TLM	438,80	Z STA LES 38 TLM	350,04

Racores DIN 2353

DIN 2353 Pipe fittings
Raccords à bague DIN 2353
Raccordi DIN 2353

Crimp fittings for hoses

Pipe fittings DIN 2353

Flare fittings JIC 37° / SAE Flanges

Adaptors

Welding fittings

Industrial fittings

Couplings, Ball valves and Hydraulic Components

Racor unión TL Métrica

Straight connection with o'ring

Raccord union tournante Métrique égale

Raccordo di estremità diritto Metrico con o'ring

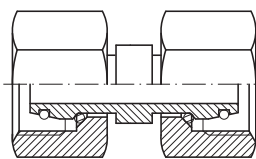

PIPE TUBO	SERIE	Part n° Referencia	€
6	L	Z ATL 6	26,15
8	L	Z ATL 8	27,41
10	L	Z ATL 10	25,40
12	L	Z ATL 12	30,98
15	L	Z ATL 15	42,89
18	L	Z ATL 18	55,83
22	L	Z ATL 22	59,75
28	L	Z ATL 28	91,82
35	L	Z ATL 35	124,32
42	L	Z ATL 42	166,11
6	S	Z ATS 6	31,40
8	S	Z ATS 8	29,30
10	S	Z ATS 10	30,14
12	S	Z ATS 12	39,38
14	S	Z ATS 14	42,40
16	S	Z ATS 16	50,14
20	S	Z ATS 20	61,32
25	S	Z ATS 25	89,67
30	S	Z ATS 30	131,15
38	S	Z ATS 38	176,30

Racor recto macho NPT - TL Metrica

Straight stud standpipe adaptor NPT- metric swivel fem.

Raccord adapteur tube lisse - mâle NPT- fem. tourn. métrique

Adattatore diritto NPT - tubo TLM

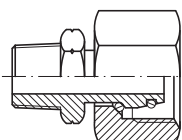

PIPE TUBO	SERIE	THREAD ROSCA	Part n° Referencia	€
6	L	1/8"NPT	Z RAL 6 R 1/8 NPPTLM	12,41
8	L	1/4"NPT	Z RAL 8 R 1/4 NPPTLM	14,55
10	L	1/4"NPT	Z RAL 10 R 1/4 NPPTLM	15,73
12	L	3/8"NPT	Z RAL 12 R 3/8 NPPTLM	20,22
15	L	1/2"NPT	Z RAL 15 R 1/2 NPPTLM	25,15
18	L	1/2"NPT	Z RAL 18 R 1/2 NPPTLM	39,06
22	L	3/4"NPT	Z RAL 22 R 3/4 NPPTLM	47,08
28	L	1"NPT	Z RAL 28 R 1 NPPTLM	80,46
35	L	1 1/4 NPT	Z RAL 35 R 1 1/4 NPPTLM	131,08
42	L	1 1/2 NPT	Z RAL 42 R 1 1/2 NPPTLM	145,31
6	S	1/4"NPT	Z RAS 6 R 1/4 NPPTLM	17,55
8	S	1/4"NPT	Z RAS 8 R 1/4 NPPTLM	17,33
10	S	3/8"NPT	Z RAS 10 R 3/8 NPPTLM	23,86
12	S	1/4" NPT	Z RAS 12 R 1/4 NPPTLM	24,72
12	S	3/8" NPT	Z RAS 12 R 3/8 NPPTLM	23,65
14	S	1/2"NPT	Z RAS 14 R 1/2 NPPTLM	29,48
16	S	1/2"NPT	Z RAS 16 R 1/2 NPPTLM	41,62
20	S	3/4"NPT	Z RAS 20 R 3/4 NPPTLM	50,50
25	S	3/4"NPT	Z RAS 25 R 3/4 NPPTLM	106,57
25	S	1"NPT	Z RAS 25 R 1 NPPTLM	88,81
30	S	1"NPT	Z RAS 30 R 1 NPPTLM	116,31
30	S	1 1/4 NPT	Z RAS 30 R 1 1/4 NPPTLM	146,16
38	S	1 1/2 NPT	Z RAS 38 R 1 1/2 NPPTLM	155,04

Racor recto macho BSP con junta plana - TLM

Straight stud standpipe adaptor with captive seal BSP cylindrical-metric swivel fem.

Raccord adapt. tube lisse-mâle gaz BSP avec joint plat-fem. tourn. métrique

Adattatore diritto BSP cilindrico con guarnizione ed o'ring

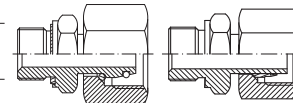

T.	S.	THREAD ROSCA	Part n° Referencia	€	Part N° Referencia	€
6	L	1/8"BSP	Z RAL 6 R 1/8TLMWD	22,68		*
8	L	1/4"BSP	Z RAL 8 R 1/4TLMWD	22,77	Z RAL 8 R 1/4CTA	21,64
10	L	1/4"BSP	Z RAL 10 R 1/4TLMWD	22,00	Z RAL 10 R 1/4CTA	20,90
12	L	1/4"BSP	Z RAL 12 R 1/4TLMWD	24,68	Z RAL 12 R 1/4CTA	15,89
12	L	3/8"BSP	Z RAL 12 R 3/8TLMWD	25,07	Z RAL 12 R 3/8CTA	23,82
12	L	1/2"BSP	Z RAL 12 R 1/2TLMWD	30,14	Z RAL 12 R 1/2CTA	18,08
15	L	1/2"BSP	Z RAL 15 R 1/2TLMWD	31,92	Z RAL 15 R 1/2CTA	30,32
18	L	1/2"BSP	Z RAL 18 R 1/2TLMWD	44,00	Z RAL 18 R 1/2CTA	41,80
22	L	1/2"BSP	Z RAL 22 R 1/2TLMWD	*	Z RAL 22 R 1/2CTA	58,64
22	L	3/4"BSP	Z RAL 22 R 3/4TLMWD	47,36	Z RAL 22 R 3/4CTA	44,99
28	L	1"BSP	Z RAL 28 R 1TLMWD	81,48	Z RAL 28 R 1CTA	77,41
35	L	1 1/4 BSP	Z RAL 35 R 1 1/4TLMWD	102,06	Z RAL 35 R 1 1/4CTA	96,96
42	L	1 1/2 BSP	Z RAL 42 R 1 1/2TLMWD	139,59	Z RAL 42 R 1 1/2CTA	132,61
6	S	1/4"BSP	Z RAS 6 R 1/4TLMWD	24,68		*
8	S	1/4"BSP	Z RAS 8 R 1/4TLMWD	21,46	Z RAS 8 R 1/4CTA	20,39
10	S	3/8"BSP	Z RAS 10 R 3/8TLMWD	26,39	Z RAS 10 R 3/8CTA	25,07
12	S	3/8"BSP	Z RAS 12 R 3/8TLMWD	25,20	Z RAS 12 R 3/8CTA	23,94
14	S	1/2"BSP	Z RAS 14 R 1/2TLMWD	34,97		*
16	S	1/2"BSP	Z RAS 16 R 1/2TLMWD	46,33	Z RAS 16 R 1/2CTA	44,01
20	S	3/4"BSP	Z RAS 20 R 3/4TLMWD	48,41	Z RAS 20 R 3/4CTA	45,98
25	S	1"BSP	Z RAS 25 R 1TLMWD	86,48	Z RAS 25 R 1CTA	82,15
30	S	1" BSP	Z RAS 30 R 1TLMWD	*	Z RAS 30 R 1CTA	115,66
30	S	1 1/4 BSP	Z RAS 30 R 1 1/4TLMWD	108,15	Z RAS 30 R 1 1/4CTA	102,74
38	S	1 1/2 BSP	Z RAS 38 R 1 1/2TLMWD	135,39	Z RAS 38 R 1 1/2CTA	128,62

Ref.CTA hasta fin de existencias.Salvo indicación expresa se suministrará TLM o CTA s/ disponibilidad / Ref.CTA until end of stock.Unless otherwise indicated, we will supply TLM or CTA if availability

Racor recto macho Métrico con junta plana - tubo TLM

Straight stud standpipe adaptor Metric with captive seal-metric swivel fem.

Raccord adapt. tube lisse-mâle Métrique avec joint plat-fem. tourn. métrique

Adattatore diritto Metrico cilindrico con guarnizione - tubo TLM

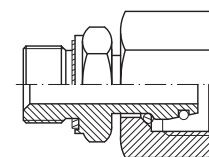

PIPE TUBO	SERIE	THREAD ROSCA	Part n° Referencia	€
6	L	M10X1	Z RAL 6M10X1TLMWD	25,54
8	L	M12X1.5	Z RAL 8M12X1.5TLMWD	22,58
10	L	M14X1.5	Z RAL 10M14X1.5TLMWD	25,10
12	L	M16X1.5	Z RAL 12M16X1.5TLMWD	27,64
15	L	M18X1.5	Z RAL 15M18X1.5TLMWD	34,65
18	L	M22X1.5	Z RAL 18M22X1.5TLMWD	44,52
22	L	M26X1.5	Z RAL 22M26X1.5TLMWD	51,35
28	L	M33X2	Z RAL 28M33X2TLMWD	81,80
35	L	M42X2	Z RAL 35M42X2TLMWD	126,16
42	L	M48X2	Z RAL 42M48X2TLMWD	142,80
6	S	M12X1.5	Z RAS 6M12X1.5TLMWD	25,73
8	S	M14X1.5	Z RAS 8M14X1.5TLMWD	24,02
10	S	M16X1.5	Z RAS 10M16X1.5TLMWD	25,10
12	S	M18X1.5	Z RAS 12M18X1.5TLMWD	29,34
14	S	M20X1.5	Z RAS 14M20X1.5TLMWD	40,16
16	S	M22X1.5	Z RAS 16M22X1.5TLMWD	44,00
20	S	M27X2	Z RAS 20M27X2TLMWD	59,75
25	S	M33X2	Z RAS 25M33X2TLMWD	88,34
30	S	M42X2	Z RAS 30M42X2TLMWD	121,70
38	S	M48X2	Z RAS 38M48X2TLMWD	157,63

Racores DIN 2353

DIN 2353 Pipe fittings
Raccords à bague DIN 2353
Raccordi DIN 2353

Racor recto para soldar

Weldable straight coupling

Raccord mamelon hexagonal Métrique à souder

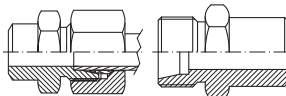

Raccordo diritto a saldare

PIPE TUBO	SERIE	Part n° Referencia	€	Part N° STA Referencia STA	€
6	L	Z ASL 6	8,66	Z STA ASL 6	5,72
8	L	Z ASL 8	9,98	Z STA ASL 8	6,86
10	L	Z ASL 10	10,76	Z STA ASL 10	7,21
12	L	Z ASL 12	12,23	Z STA ASL 12	8,82
15	L	Z ASL 15	16,33	Z STA ASL 15	10,90
18	L	Z ASL 18	25,83	Z STA ASL 18	18,42
22	L	Z ASL 22	32,55	Z STA ASL 22	24,39
28	L	Z ASL 28	47,04	Z STA ASL 28	28,83
35	L	Z ASL 35	68,25	Z STA ASL 35	40,59
42	L	Z ASL 42	96,60	Z STA ASL 42	63,58
6	S	Z ASS 6	12,08	Z STA ASS 6	7,99
8	S	Z ASS 8	14,57	Z STA ASS 8	10,13
10	S	Z ASS 10	14,18	Z STA ASS 10	10,23
12	S	Z ASS 12	16,70	Z STA ASS 12	12,13
14	S	Z ASS 14	27,30	Z STA ASS 14	18,11
16	S	Z ASS 16	25,31	Z STA ASS 16	18,96
20	S	Z ASS 20	35,60	Z STA ASS 20	23,03
25	S	Z ASS 25	55,13	Z STA ASS 25	31,83
30	S	Z ASS 30	72,45	Z STA ASS 30	45,27
38	S	Z ASS 38	117,60	Z STA ASS 38	73,22

Racor pasatabique para soldar

Weldable bulkhead coupling

Raccord union double passe cloison Métrique à souder

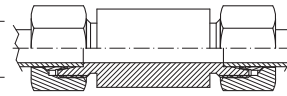

Raccordo passaparete a saldare

PIPE TUBO	SERIE	Part n° Referencia	€
6	L	Z ESVL 6	21,39
8	L	Z ESVL 8	23,15
10	L	Z ESVL 10	28,67
12	L	Z ESVL 12	31,97
15	L	Z ESVL 15	43,00
18	L	Z ESVL 18	55,06
22	L	Z ESVL 22	83,11
28	L	Z ESVL 28	103,64
35	L	Z ESVL 35	132,30
42	L	Z ESVL 42	196,25
6	S	Z ESVS 6	25,47
8	S	Z ESVS 8	29,66
10	S	Z ESVS 10	38,59
12	S	Z ESVS 12	40,79
14	S	Z ESVS 14	52,37
16	S	Z ESVS 16	66,13
20	S	Z ESVS 20	99,23
25	S	Z ESVS 25	112,81
30	S	Z ESVS 30	147,74
38	S	Z ESVS 38	207,27

Boquilla para soldar

Welding nipple with o-ring

Raccord collet cône métrique à souder

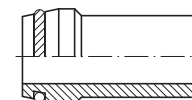

Ogiva a saldare con o'ring

PIPE TUBO	SERIE	Part n° Referencia	€
10x1.5	L	Z ORIL 10	7,61
15x2.5	L	Z ORIL 15	9,15
18x2.5	L	Z ORIL 18	13,07
22x2.5	L	Z ORIL 22	15,77
28x3	L	Z ORIL 28	21,90
35x4	L	Z ORIL 35	31,58
42x3	L	Z ORIL 42	50,36
6x1.5	S	Z ORIS 6	7,61
8x2	S	Z ORIS 8	8,05
10x2	S	Z ORIS 10	8,37
12x2	S	Z ORIS 12	8,94
14x3	S	Z ORIS 14	10,71
16x3	S	Z ORIS 16	11,45
20x3	S	Z ORIS 20	14,44
25x3.5	S	Z ORIS 25	22,00
30x5	S	Z ORIS 30	26,36
38x5	S	Z ORIS 38	37,15

Racores DIN 2353

DIN 2353 Pipe fittings
Raccords à bague DIN 2353
Raccordi DIN 2353

Crimp fittings for hoses

Pipe fittings DIN 2353

Flare fittings JIC 37° / SAE Flanges

Adaptors

Welding fittings

Industrial fittings

Couplings, Ball valves and Hydraulic Components

Racor recto pasatabique con tuerca

Straight bulkhead coupling

Raccord droit union double passe cloison avec écrou

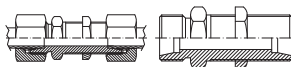

Raccordo passaparete

PIPE TUBO	SERIE	Part n° Referencia	€	Part N° STA Referencia STA	€
6	L	Z SVL 6	19,68	Z STA SVL 6	12,85
8	L	Z SVL 8	22,16	Z STA SVL 8	15,92
10	L	Z SVL 10	26,67	Z STA SVL 10	19,49
12	L	Z SVL 12	28,88	Z STA SVL 12	19,95
15	L	Z SVL 15	42,12	Z STA SVL 15	29,19
18	L	Z SVL 18	56,70	Z STA SVL 18	38,75
22	L	Z SVL 22	76,55	Z STA SVL 22	54,73
28	L	Z SVL 28	104,30		*
35	L	Z SVL 35	157,59		*
42	L	Z SVL 42	219,40		*
6	S	Z SVS 6	27,04	Z STA SVS 6	19,69
8	S	Z SVS 8	29,70	Z STA SVS 8	20,72
10	S	Z SVS 10	36,53	Z STA SVS 10	24,57
12	S	Z SVS 12	37,70	Z STA SVS 12	29,20
14	S	Z SVS 14	58,16	Z STA SVS 14	39,06
16	S	Z SVS 16	55,13	Z STA SVS 16	39,01
20	S	Z SVS 20	92,40	Z STA SVS 20	67,20
25	S	Z SVS 25	125,39	Z STA SVS 25	83,79
30	S	Z SVS 30	181,13		*
38	S	Z SVS 38	274,52		*

Racor en codo pasatabique con tuerca

Elbow bulkhead coupling

Raccord coude égal passe cloison

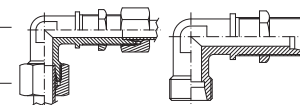

Raccordo passaparete a 90°

PIPE TUBO	SERIE	Part n° Referencia	€	Part N° STA Referencia STA	€
6	17	L Z USVL 6	44,63		*
8	19	L Z USVL 8	45,41		*
10	22	L Z USVL 10	44,63	Z STA USVL 10	33,87
12	24	L Z USVL 12	49,25	Z STA USVL 12	37,37
15	27	L Z USVL 15	75,60	Z STA USVL 15	65,14
18	32	L Z USVL 18	85,79	Z STA USVL 18	65,64
22	36	L Z USVL 22	129,05	Z STA USVL 22	102,38
28	42	L Z USVL 28	222,57		*
35	50	L Z USVL 35	399,00		*
42	60	L Z USVL 42	514,50		*
6	19	S Z USVS 6	49,14		*
8	22	S Z USVS 8	52,76		*
10	24	S Z USVS 10	55,65	Z STA USVS 10	44,56
12	27	S Z USVS 12	61,95	Z STA USVS 12	48,89
14	27	S Z USVS 14	77,70	Z STA USVS 14	59,77
16	30	S Z USVS 16	82,95	Z STA USVS 16	61,56
20	36	S Z USVS 20	128,84	Z STA USVS 20	98,65
25	42	S Z USVS 25	240,93		*
30	50	S Z USVS 30	336,00		*
38	60	S Z USVS 38	519,75		*

Tuerca pasatabique Métrica

Metric nut bulkhead

Écrou Métrique passe cloison

Dado passaparete Metrico



PIPE TUBO	THREAD ROSCA	Part n° Referencia	€
6L	M12x1.5	KZTPM12	2,03
8L / 6S	M14x1.5	KZTPM14	2,25
10L / 8S	M16x1.5	KZTPM16	2,89
12L / 10S	M18x1.5	KZTPM18	3,64
12S	M20x1.5	KZTPM20	4,49
15L / 14S	M22x1.5	KZTPM22	5,78
16S	M24x1.5	KZTPM24	6,96
18L	M26x1.5	KZTPM26	10,59
22L / 20S	M30x2	KZTPM30	13,27
28L / 25S	M36x2	KZTPM36	19,58
30S	M42x2	KZTPM42	26,54
35L	M45x2	KZTPM45	26,96
42L / 38S	M52x2	KZTPM52	37,02

Racores DIN 2353

DIN 2353 Pipe fittings
Raccords à bague DIN 2353
Raccordi DIN 2353

Racor recto hembra rosca BSP

Female stud coupling

Raccord union simple femelle gaz

Raccordo diritto femmina BSP

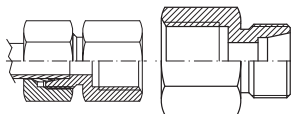

T.	S.	THREAD ROSCA	Part n° Referencia	€	Part N° STA Referencia STA	€
6	L	1/8" BSP	Z GAIL 6 R 1/8	13,85	Z STA GAIL 6 R 1/8	10,98
6	L	1/4" BSP	Z GAIL 6 R 1/4	14,60	Z STA GAIL 6 R 1/4	12,20
8	L	1/4" BSP	Z GAIL 8 R 1/4	17,42	Z STA GAIL 8 R 1/4	13,70
10	L	1/4" BSP	Z GAIL 10 R 1/4	16,49	Z STA GAIL 10 R 1/4	12,99
12	L	1/2" BSP	Z GAIL 12 R 1/2	23,46		*
12	L	3/8" BSP	Z GAIL 12 R 3/8	20,90	Z STA GAIL 12 R 3/8	16,80
15	L	1/2" BSP	Z GAIL 15 R 1/2	25,10	Z STA GAIL 15 R 1/2	19,64
18	L	1/2" BSP	Z GAIL 18 R 1/2	31,22	Z STA GAIL 18 R 1/2	22,23
22	L	3/4" BSP	Z GAIL 22 R 3/4	40,69	Z STA GAIL 22 R 3/4	28,96
28	L	1" BSP	Z GAIL 28 R 1	59,50		*
35	L	1 1/4" BSP	Z GAIL 35 R 1 1/4	119,00		*
42	L	1 1/2" BSP	Z GAIL 42 R 1 1/2	117,60		*
6	S	1/4" BSP	Z GAIS 6 R 1/4	17,42	Z STA GAIS 6 R 1/4	13,36
8	S	1/4" BSP	Z GAIS 8 R 1/4	17,53	Z STA GAIS 8 R 1/4	13,07
10	S	3/8" BSP	Z GAIS 10 R 3/8	23,04	Z STA GAIS 10 R 3/8	17,11
12	S	3/8" BSP	Z GAIS 12 R 3/8	24,37	Z STA GAIS 12 R 3/8	18,90
14	S	3/8" BSP	Z GAIS 14 R 3/8	37,34		*
14	S	1/2" BSP	Z GAIS 14 R 1/2	31,01	Z STA GAIS 14 R 1/2	23,40
16	S	1/2" BSP	Z GAIS 16 R 1/2	32,69	Z STA GAIS 16 R 1/2	22,16
20	S	3/4" BSP	Z GAIS 20 R 3/4	51,54		*
25	S	1" BSP	Z GAIS 25 R 1	68,98	Z STA GAIS 25 R 1	42,90
30	S	1 1/4" BSP	Z GAIS 30 R 1 1/4	109,20		*
38	S	1 1/2" BSP	Z GAIS 38 R 1 1/2	140,57		*

Racor para manómetro BSP

Gauge coupling BSP cylindrical

Raccord union pour manomètre gaz

Raccordo per manometro BSP

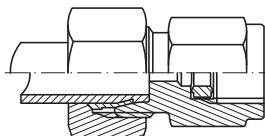

PIPE TUBO	SERIE	THREAD ROSCA	Part n° Referencia	€
6	L	1/4" BSP	Z MAVL 6 R 1/4	15,54
8	L	1/4" BSP	Z MAVL 8 R 1/4	15,96
10	L	1/4" BSP	Z MAVL 10 R 1/4	17,22
12	L	1/4" BSP	Z MAVL 12 R 1/4	18,27
6	S	1/2" BSP	Z MAVS 6 R 1/2	22,26
8	S	1/2" BSP	Z MAVS 8 R 1/2	24,05
10	S	1/2" BSP	Z MAVS 10 R 1/2	24,09
12	S	1/2" BSP	Z MAVS 12 R 1/2	24,78

Racor recto hembra rosca Métrica

Female stud coupling Metric Cylindrical

Raccord union simple femelle Métrique

Raccordo diritto femmina Metrico

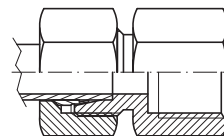

PIPE TUBO	SERIE	THREAD ROSCA	Part n° Referencia	€
6	L	M10X1	Z GAIL 6 M 10X1	15,55
8	L	M12X1.5	Z GAIL 8 M 12X1.5	19,29
10	L	M14X1.5	Z GAIL 10 M 14X1.5	20,37
12	L	M16X1.5	Z GAIL 12 M 16X1.5	25,52
15	L	M18X1.5	Z GAIL 15 M 18X1.5	34,44
18	L	M22X1.5	Z GAIL 18 M 22X1.5	40,95
22	L	M26X1.5	Z GAIL 22 M 26X1.5	47,30
28	L	M33X2	Z GAIL 28 M 33X2	71,66
35	L	M42X2	Z GAIL 35 M 42X2	123,90
42	L	M48X2	Z GAIL 42 M 48X2	164,65
6	S	M12X1.5	Z GAIS 6 M 12X1.5	21,00
8	S	M14X1.5	Z GAIS 8 M 14X1.5	25,41
10	S	M16X1.5	Z GAIS 10 M 16X1.5	25,69
12	S	M18X1.5	Z GAIS 12 M 18X1.5	30,45
14	S	M20X1.5	Z GAIS 14 M 20X1.5	38,25
16	S	M22X1.5	Z GAIS 16 M 22X1.5	43,00
20	S	M27X2	Z GAIS 20 M 27X2	57,33
25	S	M33X2	Z GAIS 25 M 33X2	91,82
30	S	M42X2	Z GAIS 30 M 42X2	128,10
38	S	M48X2	Z GAIS 38 M 48X2	189,00

Arandela para manómetros

Seal for gauge coupling

Raccord bague pour manomètres

Guarnizione per manometro

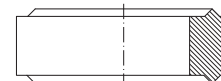

THREAD ROSCA	Part n° Referencia	€
R 1/4" BSP	Z AM 6	4,88
R 1/2" BSP	Z AM 12	6,29

Racores DIN 2353

DIN 2353 Pipe fittings
Raccords à bague DIN 2353
Raccordi DIN 2353

Crimp fittings for hoses

Pipe fittings DIN 2353

Flare fittings JIC 37° / SAE Flanges

Adaptors

Welding fittings

Industrial fittings

Couplings, Ball valves and Hydraulic Components

Racor en codo orientable sin estrangulación rosca BSP

Banjo coupling with captive seal and o'ring BSP cylindrical

Raccord équerre orientable articulée sans étranglement gaz

Raccordo orientabile 90° ad occhio BSP con guarnizione

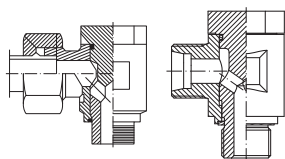

T.	S.	THREAD ROSCA	Part n° Referencia	€	Part N° STA Referencia STA	€
6	L	1/8" BSP	Z WSVL 6 R 1/8	81,90	Z STA WSVL 6 R 1/8	78,96
8	L	1/4" BSP	Z WSVL 8 R 1/4	77,59	Z STA WSVL 8 R 1/4	74,47
10	L	1/4" BSP	Z WSVL 10 R 1/4	84,46	Z STA WSVL 10 R 1/4	80,90
12	L	3/8" BSP	Z WSVL 12 R 3/8	101,43	Z STA WSVL 12 R 3/8	97,33
15	L	1/2" BSP	Z WSVL 15 R 1/2	135,45	Z STA WSVL 15 R 1/2	130,02
18	L	1/2" BSP	Z WSVL 18 R 1/2	156,98	Z STA WSVL 18 R 1/2	149,56
22	L	3/4" BSP	Z WSVL 22 R 3/4	250,13	Z STA WSVL 22 R 3/4	241,96
28	L	1" BSP	Z WSVL 28 R 1	493,06	Z STA WSVL 28 R 1	467,71
35	L	1 1/4" BSP	Z WSVL 35 R 1 1/4	598,50	Z STA WSVL 35 R 1 1/4	560,46
42	L	1 1/2" BSP	Z WSVL 42 R 1 1/2	892,50	Z STA WSVL 42 R 1 1/2	845,46
6	S	1/4" BSP	Z WSVS 6 R 1/4	79,43	Z STA WSVS 6 R 1/4	75,35
8	S	1/4" BSP	Z WSVS 8 R 1/4	87,13	Z STA WSVS 8 R 1/4	82,68
10	S	3/8" BSP	Z WSVS 10 R 3/8	98,46	Z STA WSVS 10 R 3/8	94,51
12	S	3/8" BSP	Z WSVS 12 R 3/8	122,85	Z STA WSVS 12 R 3/8	118,28
14	S	1/2" BSP	Z WSVS 14 R 1/2	143,85	Z STA WSVS 14 R 1/2	137,10
16	S	1/2" BSP	Z WSVS 16 R 1/2	163,38	Z STA WSVS 16 R 1/2	157,03
20	S	3/4" BSP	Z WSVS 20 R 3/4	247,57	Z STA WSVS 20 R 3/4	237,74
25	S	1" BSP	Z WSVS 25 R 1	435,75	Z STA WSVS 25 R 1	403,73
30	S	1 1/4" BSP	Z WSVS 30 R 1 1/4	*		*
38	S	1 1/2" BSP	Z WSVS 38 R 1 1/2	*		*

Racor en codo orientable sin estrangulación rosca Métrica

Banjo coupling with captive seal and o'ring Metric cylindrical

Raccord équerre orientable articulée sans étranglement Métrique

Raccordo orientabile 90° ad occhio Metrico con guarnizione

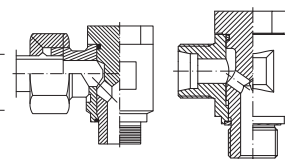

T.	S.	THREAD ROSCA	Part n° Referencia	€	Part N° STA Referencia STA	€
6	L	M10X1	Z WSVL 6 M 10X1	86,10	Z STA WSVL 6 M 10X1	83,15
8	L	M12X1.5	Z WSVL 8 M 12X1,5	88,20	Z STA WSVL 8 M 12X1,5	85,08
10	L	M14X1.5	Z WSVL 10 M 14X1,5	92,40	Z STA WSVL 10 M 14X1,5	88,84
12	L	M16X1.5	Z WSVL 12 M 16X1,5	110,25	Z STA WSVL 12 M 16X1,5	106,16
15	L	M18X1.5	Z WSVL 15 M 18X1,5	136,50	Z STA WSVL 15 M 18X1,5	131,07
18	L	M22X1.5	Z WSVL 18 M 22X1,5	171,15	Z STA WSVL 18 M 22X1,5	163,74
22	L	M26X1.5	Z WSVL 22 M 26X1,5	*	Z STA WSVL 22 M 26X1,5	*
28	L	M33X2	Z WSVL 28 M 33X2	*	Z STA WSVL 28 M 33X2	*
35	L	M42X2	Z WSVL 35 M 42X2	*	Z STA WSVL 35 M 42X2	*
42	L	M48X2	Z WSVL 42 M 48X2	*	Z STA WSVL 42 M 48X2	*
6	S	M12X1.5	Z WSVS 6 M 12X1,5	79,53	Z STA WSVS 6 M 12X1,5	75,45
8	S	M14X1.5	Z WSVS 8 M 14X1,5	88,96	Z STA WSVS 8 M 14X1,5	84,51
10	S	M16X1.5	Z WSVS 10 M 16X1,5	105,94	Z STA WSVS 10 M 16X1,5	101,99
12	S	M18X1.5	Z WSVS 12 M 18X1,5	115,35	Z STA WSVS 12 M 18X1,5	110,78
14	S	M20X1.5	Z WSVS 14 M 20X1,5	161,70		*
16	S	M22X1.5	Z WSVS 16 M 22X1,5	170,52	Z STA WSVS 16 M 22X1,5	164,17
20	S	M27X2	Z WSVS 20 M 27X2	253,44	Z STA WSVS 20 M 27X2	243,61
30	S	M42X2	Z WSVS 30 M 42X2	*		*
38	S	M48X2	Z WSVS 38 M 48X2	*		*

Racores DIN 2353

DIN 2353 Pipe fittings
Raccords à bague DIN 2353
Raccordi DIN 2353

Tapón de cierre para tubo con junta tórica

Blanking plug with o-ring

Raccord bouchon de fermeture avec o-ring

Tappo di chiusura con o-ring

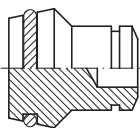

PIPE TUBO	SERIE	Part n° Referencia	€
6	L	Z BUTZEN L 6	6,72
8	L	Z BUTZEN L 8	6,09
10	L	Z BUTZEN L 10	6,28
12	L	Z BUTZEN L 12	7,51
15	L	Z BUTZEN L 15	8,38
18	L	Z BUTZEN L 18	10,82
22	L	Z BUTZEN L 22	14,89
28	L	Z BUTZEN L 28	22,05
35	L	Z BUTZEN L 35	37,80
14	S	Z BUTZEN S 14	10,24
16	S	Z BUTZEN S 16	10,69
20	S	Z BUTZEN S 20	14,47
25	S	Z BUTZEN S 25	18,38
30	S	Z BUTZEN S 30	30,35
38	S	Z BUTZEN S 38	45,26
42	L	Z BUTZEN L 42	47,25

Tapón de cierre Allen rosca BSP con junta

Blanking plug with captive seal BSP cylindrical

Raccord bouchon Allen gaz avec joint plat

Tappo cilindrico BSP esagono incassato con guarnizione

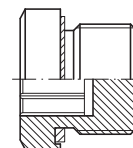

THREAD ROSCA	Part n° Referencia	€
1/8" BSP	Z STOPFEN 1/8	6,98
1/4" BSP	Z STOPFEN 1/4	7,74
3/8" BSP	Z STOPFEN 3/8	8,96
1/2" BSP	Z STOPFEN 1/2	11,58
3/4" BSP	Z STOPFEN 3/4	16,31
1" BSP	Z STOPFEN 1	25,48
1"1/4 BSP	Z STOPFEN 1 1/4	37,99
1"1/2 BSP	Z STOPFEN 1 1/2	52,75

Tapón de cierre Allen rosca Métrica con junta

Blanking plug with captive seal Metric cylindrical

Raccord bouchon Allen Métrique avec joint plat

Tappo cilindrico Metrico esagono incassato con guarnizione

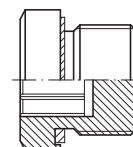

THREAD ROSCA	Part n° Referencia	€
M10X1	Z STOPFEN M 10X1	7,80
M12X1.5	Z STOPFEN M 12X1,5	8,73
M14X1.5	Z STOPFEN M 14X1,5	8,36
M16X1.5	Z STOPFEN M 16X1,5	9,84
M18X1.5	Z STOPFEN M 18X1,5	11,15
M20X1.5	Z STOPFEN M 20X1,5	15,59
M22X1.5	Z STOPFEN M 22X1,5	17,69
M26X1.5	Z STOPFEN M 26X1,5	24,99
M27X2	Z STOPFEN M 27X2	25,67
M33X2	Z STOPFEN M 33X2	46,28
M42X2	Z STOPFEN M 42X2	54,99
M48X2	Z STOPFEN M 48X2	73,50

Juntas tóricas FKM verde

Green FKM o-ring

Joint torique en FKM vert

Guarnizioni o'Rings FKM verde

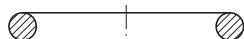

PIPE TUBO	Part n° Referencia	€
6	JVT06	0,77
8	JVT08	0,83
10	JVT10	0,90
12	JVT12	0,96
14	JVT14	1,03
15-16	JVT15	1,03
18	JVT18	1,22
20	JVT20	1,22
22	JVT22	1,28
25	JVT25	1,35
28	JVT28	1,41
30	JVT30	1,48
35	JVT35	2,05
38	JVT38	2,12
42	JVT42	2,31

Juntas planas FKM verde

Green FKM captive seal

Joint plat en FKM vert

Guarnizioni piatte FKM verde

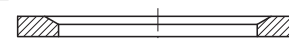

THREAD ROSCA	Part n° Referencia	€
1/8" BSP - M10x1	JVBSP02	2,95
M12x1.5	JVM12	2,95
1/4" BSP - M14x1.5	JVBSP04	2,95
M16x1.5	JVM16	2,95
3/8" BSP	JVBSP06	2,95
M18x1.5	JVM18	3,08
M20x1.5	JVM20	3,08
1/2" BSP	JVBSP08	3,15
M22x1.5	JVM22	3,15
3/4" BSP - M26x1.5	JVBSP12	3,21
1" BSP - M33x2	JVBSP16	3,34
1"1/4 BSP - M42x2	JVBSP20	5,01
1"1/2 BSP - M48x2	JVBSP24	5,39
2" BSP	JVBSP32	16,50

Racores DIN 2353

DIN 2353 Pipe fittings
Raccords à bague DIN 2353
Raccordi DIN 2353

Crimp fittings for hoses

Pipe fittings DIN 2353

Flare fittings JIC 37° / SAE Flanges

Adaptors

Welding fittings

Industrial fittings

Couplings, Ball valves and Hydraulic Components

Vomo

Tool

Outil

Atrezzo

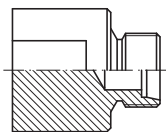

PIPE TUBO	SERIE	Part nº Referencia	€
6	L	Z VOMO L 6	*
8	L	Z VOMO L 8	*
10	L	Z VOMO L 10	*
12	L	Z VOMO L 12	*
15	L	Z VOMO L 15	*
18	L	Z VOMO L 18	*
22	L	Z VOMO L 22	*
28	L	Z VOMO L 28	*
35	L	Z VOMO L 35	*
42	L	Z VOMO L 42	*
6	S	Z VOMO S 6	*
8	S	Z VOMO S 8	*
10	S	Z VOMO S 10	*
12	S	Z VOMO S 12	*
14	S	Z VOMO S 14	*
16	S	Z VOMO S 16	*
20	S	Z VOMO S 20	*
25	S	Z VOMO S 25	*
30	S	Z VOMO S 30	*
38	S	Z VOMO S 38	*

Material Acero Templado / Made of Hardened tool-steel / Matériel Acier Trempé / Materiale acciaio temprato

Grasa

Grease

Graisse

Lubrificante



DESCRIPTION DESCRIPCIÓN	Part nº Referencia	€
Grease	GR ASW120	*

Racores DIN 2353

DIN 2353 Pipe fittings
Raccords à bague DIN 2353
Raccordi DIN 2353

Válvula antirretorno rosca BSP-tubo

Non-return valve flow from male stud end BSP cylindrical

Clapet anti-rétour unidirectionnel à gauche mâle-tube

Valvola di ritegno a sinistra

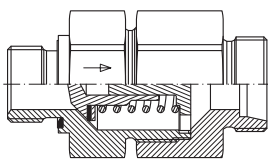

PIPE TUBO	SERIE	THREAD ROSCA	Part nº Referencia	€
6	L	M 1/8" BSP	Z RHVL 6 R 1/8	82,69
8	L	M 1/4" BSP	Z RHVL 8 R 1/4	86,82
10	L	M 1/4" BSP	Z RHVL 10 R 1/4	108,87
12	L	M 3/8" BSP	Z RHVL 12 R 3/8	119,90
15	L	M 1/2" BSP	Z RHVL 15 R 1/2	150,22
18	L	M 1/2" BSP	Z RHVL 18 R 1/2	186,05
22	L	M 3/4" BSP	Z RHVL 22 R 3/4	372,09
28	L	M 1" BSP	Z RHVL 28 R 1	399,66
35	L	M 1 1/4" BSP	Z RHVL 35 R 1 1/4	587,08
42	L	M 1 1/2" BSP	Z RHVL 42 R 1 1/2	937,13
6	S	M 1/4" BSP	Z RHVS 6 R 1/4	103,36
8	S	M 1/4" BSP	Z RHVS 8 R 1/4	115,76
10	S	M 3/8" BSP	Z RHVS 10 R 3/8	150,22
12	S	M 3/8" BSP	Z RHVS 12 R 3/8	133,68
14	S	M 1/2" BSP	Z RHVS 14 R 1/2	192,94
16	S	M 1/2" BSP	Z RHVS 16 R 1/2	191,56
20	S	M 3/4" BSP	Z RHVS 20 R 3/4	282,52
25	S	M 1" BSP	Z RHVS 25 R 1	350,04
30	S	M 1 1/4" BSP	Z RHVS 30 R 1 1/4	540,23
38	S	M 1 1/2" BSP	Z RHVS 38 R 1 1/2	756,59

Válvula antirretorno tubo-rosca BSP

Non-return valve flow towards male stud end BSP cylindrical

Clapet anti-rétour unidirectionnel à droite tube-mâle

Valvola di ritegno a destra

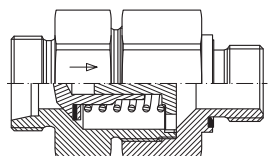

PIPE TUBO	SERIE	THREAD ROSCA	Part nº Referencia	€
6	L	M 1/8" BSP	Z RHZL 6 R 1/8	82,69
8	L	M 1/4" BSP	Z RHZL 8 R 1/4	86,82
10	L	M 1/4" BSP	Z RHZL 10 R 1/4	111,63
12	L	M 3/8" BSP	Z RHZL 12 R 3/8	119,90
15	L	M 1/2" BSP	Z RHZL 15 R 1/2	150,22
18	L	M 1/2" BSP	Z RHZL 18 R 1/2	186,05
22	L	M 3/4" BSP	Z RHZL 22 R 3/4	372,09
28	L	M 1" BSP	Z RHZL 28 R 1	399,66
35	L	M 1 1/4" BSP	Z RHZL 35 R 1 1/4	587,08
42	L	M 1 1/2" BSP	Z RHZL 42 R 1 1/2	937,13
6	S	M 1/4" BSP	Z RHZS 6 R 1/4	108,87
8	S	M 1/4" BSP	Z RHZS 8 R 1/4	115,76
10	S	M 3/8" BSP	Z RHZS 10 R 3/8	144,70
12	S	M 3/8" BSP	Z RHZS 12 R 3/8	133,68
14	S	M 1/2" BSP	Z RHZS 14 R 1/2	192,94
16	S	M 1/2" BSP	Z RHZS 16 R 1/2	191,56
20	S	M 3/4" BSP	Z RHZS 20 R 3/4	282,52
25	S	M 1" BSP	Z RHZS 25 R 1	350,04
30	S	M 1 1/4" BSP	Z RHZS 30 R 1 1/4	540,23
38	S	M 1 1/2" BSP	Z RHZS 38 R 1 1/2	756,59

Válvula antirretorno tubo-tubo

Non-return valve tube-tube

Clapet anti-rétour bidirectionnel tube-tube

Valvola di ritegno tubo-tubo

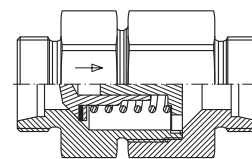

PIPE TUBO	SERIE	Part nº Referencia	€
6	L	Z RHDL 6	101,98
8	L	Z RHDL 8	108,87
10	L	Z RHDL 10	113,01
12	L	Z RHDL 12	143,33
15	L	Z RHDL 15	161,24
18	L	Z RHDL 18	219,12
22	L	Z RHDL 22	286,65
28	L	Z RHDL 28	394,14
35	L	Z RHDL 35	584,33
42	L	Z RHDL 42	757,97
6	S	Z RHDS 6	117,14
8	S	Z RHDS 8	117,14
10	S	Z RHDS 10	135,06
12	S	Z RHDS 12	148,84
14	S	Z RHDS 14	227,39
16	S	Z RHDS 16	187,43
20	S	Z RHDS 20	254,95
25	S	Z RHDS 25	378,98
30	S	Z RHDS 30	530,58
38	S	Z RHDS 38	752,46

Abrazaderas

Clamps
Colliers
Collari fissatubo

Abrazadera ligera simple completa

Complete simple clamp

Collier simple complet

Collari fissatubo singoli completo



DN	GROUP GRUPO	Part n° Referencia	€
6	G-1	ZA40AZ06	11,01
8	G-1	ZA40AZ08	11,01
10	G-1	ZA40AZ10	11,01
12	G-1	ZA40AZ12	11,01
14	G-2	ZA40AZ14	11,62
15	G-2	ZA40AZ15	11,62
16	G-2	ZA40AZ16	11,62
18	G-2	ZA40AZ18	11,62
20	G-3	ZA40AZ20	12,42
22	G-3	ZA40AZ22	12,42
23	G-3	ZA40AZ23	12,42
25	G-3	ZA40AZ25	12,42
28	G-4	ZA40AZ28	13,71
30	G-4	ZA40AZ30	13,71
38	G-5	ZA40AZ38	15,83
40	G-5	ZA40AZ40	15,83
42	G-5	ZA40AZ42	15,83

Abrazadera ligera reforzada completa

Complete reinforced clamp

Collier de fixation simple série légère renforcé complet

Collare fissatubo rinforzato completo



DN	GROUP GRUPO	Part n° Referencia	€
6	G-1	ZA41AZ06	13,99
8	G-1	ZA41AZ08	13,99
10	G-1	ZA41AZ10	13,99
12	G-1	ZA41AZ12	13,99
14	G-2	ZA41AZ14	14,94
15	G-2	ZA41AZ15	14,94
16	G-2	ZA41AZ16	14,94
18	G-2	ZA41AZ18	14,94
20	G-3	ZA41AZ20	16,20
22	G-3	ZA41AZ22	16,20
23	G-3	ZA41AZ23	16,20
25	G-3	ZA41AZ25	16,20
28	G-4	ZA41AZ28	17,44
30	G-4	ZA41AZ30	17,44
38	G-5	ZA41AZ38	20,61
40	G-5	ZA41AZ40	20,61
42	G-5	ZA41AZ42	20,61



Abrazaderas

Clamps
Colliers
Collari fissatubo

Plásticos polipropileno, serie ligera

Plastics polypropylene, light serie

Plastique polypropylene, série légère

Plastica polipropilene



DN	GROUP GRUPO	Part nº Referencia	€
6	1	A106C	*
8	1	A108C	*
10	1	A110C	*
12	1	A112C	*
1/4"	2	A213.2C	*
14	2	A214C	*
15	2	A215C	*
3/8"	2	A216.7C	*
16	2	A216C	*
18	2	A218C	*
19	3	A319C	*
20	3	A320C	*
1/2"	3	A321.3C	*
22	3	A322C	*
23	3	A323C	*
25	3	A325C	*
3/4"	4	A426.7C	*
28	4	A428C	*
30	4	A430C	*
32	5	A532C	*
1"	5	A533.7C	*
35	5	A535C	*
38	5	A538C	*
40	5	A540C	*
42	5	A542C	*
44.5	6	A644.5C	*
1"1/2	6	A648.3C	*
50.8	6	A650.8C	*

Precio por pareja.*Ver precios en Tarifa Conducciones Hidráulicas y Neumáticas / Price per couple.*See prices in Hydraulic and Pneumatic Connectors' Catalogue / Prix par paire.*Voir les prix dans le Catalogue Connectique Hydraulique et Pneumatique

Chapas inferiores, serie ligera

Lower plate, light serie

Plaque inférieure, série légère

Piastre inferiori



GROUP GRUPO	Part nº Referencia	€
1	ZAPIN1	8,68
2	ZAPIN2	9,02
3	ZAPIN3	9,41
4	ZAPIN4	9,80
5	ZAPIN5	10,47
6	ZAPIN6	13,05

Chapas superiores, serie ligera

Upper plate, light serie

Plaque supérieure, série légère

Piastre superiore



GROUP GRUPO	Part nº Referencia	€
1	ZAPS1	2,71
2	ZAPS2	3,00
3	ZAPS3	3,39
4	ZAPS4	3,87
5	ZAPS5	4,50
6	ZAPS6	5,18

Tornillos Allen, serie ligera

Allen screw, light serie

Vis Allen, série légère

Vite Allen



THREAD ROSCA	GROUP GRUPO	Part nº Referencia	€
M6	1	ZAVTC1	0,97
M6	2	ZAVTC2	0,45
M6	3	ZAVTC3	1,22
M6	4	ZAVTC4	1,59
M6	5	ZAVTC5	2,05
M6	6	ZAVTC6	2,54

Precio por unidad / Price per unit / Prix à l'unité / Prezzo unitario

Tornillos Hexagonales, serie ligera

Hexagonal screw, light serie

Vis Hexagonal, série légère

Vite esagonale



THREAD ROSCA	GROUP GRUPO	Part nº Referencia	€
M6	1	ZAVTE1	0,97
M6	2	ZAVTE2	1,10
M6	3	ZAVTE3	1,35
M6	4	ZAVTE4	1,43
M6	5	ZAVTE5	2,11
M6	6	ZAVTE6	3,05

Precio por unidad / Price per unit / Prix à l'unité / Prezzo unitario

Abrazaderas

Clamps
Colliers
Collari fissatubo

Abrazaderas dobles completas

Double clamp - parallel

Colliers de fixation doubles complets

Collare fissatubo doppio completo



DN	GROUP GRUPO	Part n° Referencia	€
6	G.1	ZAZCFS06	10,23
8	G.1	ZAZCFS08	10,23
10	G.1	ZAZCFS10	10,23
12	G.1	ZAZCFS12	10,23
14	G.2	ZAZCFS14	20,21
15	G.2	ZAZCFS15	20,21
16	G.2	ZAZCFS16	20,21
18	G.2	ZAZCFS18	20,21
20	G.3	ZAZCFS20	21,77
22	G.3	ZAZCFS22	21,77
25	G.3	ZAZCFS25	21,77
28	G.4	ZAZCFS28	26,51
30	G.4	ZAZCFS30	26,51
35	G.5	ZAZCFS35	31,47
38	G.5	ZAZCFS38	31,47
40	G.5	ZAZCFS40	31,47
42	G.5	ZAZCFS42	31,47

Chapas inferiores

Lower plate double

Plaques inférieures à souder double

Piastre inferiori



THREAD ROSCA	GROUP GRUPO	Part n° Referencia	€
M6	1	ZADPIN1	5,66
M8	2	ZADPIN2	12,95
M8	3	ZADPIN3	13,78
M8	4	ZADPIN4	14,73
M8	5	ZADPIN5	16,28

Chapas superiores

Upper plate double

Plaques supérieures de protection double

Piastre superiori



GROUP GRUPO	Part n° Referencia	€
1	ZADPS1	2,92
2	ZADPS2	4,50
3	ZADPS3	4,99
4	ZADPS4	8,50
5	ZADPS5	10,42

Plásticos polipropileno dobles

Plastics polypropylene doubles

Plastiques polypropylene doubles

Plastica polipropilene



DN	GROUP GRUPO	Part n° Referencia	€
6	1	AD106C	*
8	1	AD108C	*
10	1	AD110C	*
12	1	AD112C	*
1/4"	2	AD213.2C	*
14	2	AD214C	*
15	2	AD215C	*
3/8"	2	AD216.7C	*
16	2	AD216C	*
18	2	AD218C	*
19	3	AD319C	*
20	3	AD320C	*
1/2"	3	AD321.3C	*
22	3	AD322C	*
25	3	AD325C	*
3/4"	4	AD426.7C	*
28	4	AD428C	*
30	4	AD430C	*
32	5	AD532C	*
1"	5	AD533.3C	*
35	5	AD535C	*
38	5	AD538C	*
40	5	AD540C	*
42	5	AD542C	*

Precio por pareja.*Ver precios en Tarifa Conducciones Hidráulicas y Neumáticas / Price per couple.*See prices in Hydraulic and Pneumatic Connectors' Catalogue / Prix par paire.*Voir les prix dans le Catalogue Connectique Hydraulique et Pneumatique

Tornillos cabeza hexagonal

Hexagonal bolt double

Vis hexagonale

Vite esagonale



THREAD ROSCA	GROUP GRUPO	Part n° Referencia	€
M6	1	ZADVTE1	1,22
M8	2	ZADVTE2	2,43
M8	3	ZADVTE3	2,51
M8	4	ZADVTE4	2,59
M8	5	ZADVTE5	3,46

Precio por unidad / Price per unit / Prix à l'unité / Prezzo unitario

Abrazaderas

Clamps
Colliers
Collari fissatubo

Accesorios para carril

Rail accessories

Accessoires pour rail

Accessori per lane



THREAD ROSCA	DESCRIPTION DESCRIPCIÓN	Part n° Referencia	€
M6	Rail nut	TC6I	10,41
M8	Rail nut	TC8I	14,52
--	Mounting rail	TS11I	60,62
--	Mounting rail	TS14I	67,03

Plásticos polipropileno, serie pesada

Plastics polypropylene, heavy serie

Plastique polypropylene, série lourde

Plastica polipropilene, serie pesante



DN	GROUP GRUPO	Part n° Referencia	€
6	1	AMPP106C	*
8	1	AMPP108C	*
10	1	AMPP110C	*
12	1	AMPP112C	*
1/4"	1	AMPP113.2C	*
14	1	AMPP114C	*
15	1	AMPP115C	*
16	1	AMPP116C	*
18	1	AMPP118C	*
20	2	AMPP220C	*
1/2"	2	AMPP221.3C	*
22	2	AMPP222C	*
25	2	AMPP225C	*
3/4"	2	AMPP226.7C	*
28	2	AMPP228C	*
30	2	AMPP230C	*
30	3	AMPP330C	*
32	3	AMPP332C	*
1"	3	AMPP333.3C	*
35	3	AMPP335C	*
38	3	AMPP338C	*
40	3	AMPP340C	*
42	3	AMPP342C	*
38	4	AMPP438C	*
42	4	AMPP442C	*
45	4	AMPP444.5C	*
45	4	AMPP445C	*
1"1/2	4	AMPP448.4C	*
48	4	AMPP448C	*
50	4	AMPP450C	*
55	4	AMPP455C	*
2"	4	AMPP460.3C	*
65	4	AMPP465C	*
70	4	AMPP470C	*

Precio por pareja.*Ver precios en Tarifa Conducciones Hidráulicas y Neumáticas / Price per couple.*See prices in Hydraulic and Pneumatic Connectors' Catalogue / Prix par paire.*Voir les prix dans le Catalogue Connectique Hydraulique et Pneumatique

Chapas inferiores, serie pesada

Lower plate, heavy serie

Plaque inférieure, série lourde

Piastre inferiori, serie pesante



THREAD ROSCA	GROUP GRUPO	Part n° Referencia	€
M10	1	ZAPINP1	32,31
M10	2	ZAPINP2	42,59
M10	3	ZAPINP3	52,85
M12	4	ZAPINP4	80,54

Chapas superiores, serie pesada

Upper plate, heavy serie

Plaque supérieure, série lourde

Piastre superiori, serie pesante



GROUP GRUPO	Part n° Referencia	€
1	ZAPSP1	14,78
2	ZAPSP2	16,75
3	ZAPSP3	21,92
4	ZAPSP4	50,14

Tornillos, serie pesada

Screw, heavy serie

Vis, série lourde

Vite, serie pesante



THREAD ROSCA	GROUP GRUPO	Part n° Referencia	€
M10	1	ZAVTEP1	3,83
M10	2	ZAVTEP2	4,55
M10	3	ZAVTEP3	5,20
M12	4	ZAVTEP4	10,98

Precio por unidad / Price per unit / Prix à l'unité / Prezzo unitario

UN PROVEEDOR MÚLTIPLES SOLUCIONES

FABRICACIÓN · MANUFACTURING



LOGÍSTICA · LOGISTICS



ÁREA CALIDAD · QUALITY DEPARTMENT



ÁREA TÉCNICA · TECHNICAL DEPARTMENT



ONE SUPPLIER MULTIPLE SOLUTIONS

www.dicsaes.com

SERVICIOS COMERCIALES · COMMERCIAL SERVICES



PLATAFORMA DIGITAL · DIGITAL PLATFORM



TALLER HIDRÁULICA · HYDRAULIC WORKSHOP



TALLER LATIGUILLOS · HOSE ASSEMBLIES WORKSHOP



TALLER SOLDADURA · WELDING WORKSHOP



Racores JIC 37° / Bridas SAE

Flare fittings JIC 37° / SAE Flanges

Raccords JIC 37° / Brides SAE

Raccordi JIC 37° / Flange SAE

Racores JIC 37°

Flare fittings JIC 37°

Raccords JIC 37°

Raccordi JIC 37°

120

Bridas SAE

SAE Flanges

Brides SAE

Flange SAE

129

3

Racores JIC 37°

Flare fittings JIC 37°

Raccords JIC 37°

Raccordi JIC 37°

■ Tuercas, ferulas y tapones JIC 37° / JIC 37° Nuts, sleeves and plugs / Écrous, ferrules et bouchons JIC 37° / Dadi, bussole e tappi JIC 37°

| 120

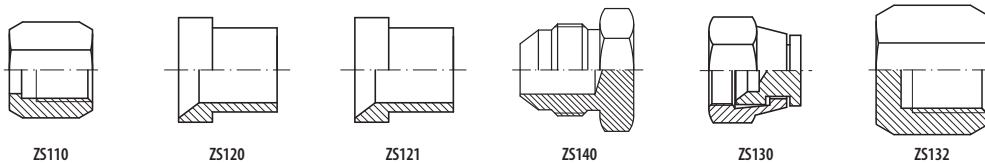

■ Uniones rectas JIC 37° / JIC 37° Straight unions / Union droite JIC 37° / Adattatori diritti JIC 37°

| 121

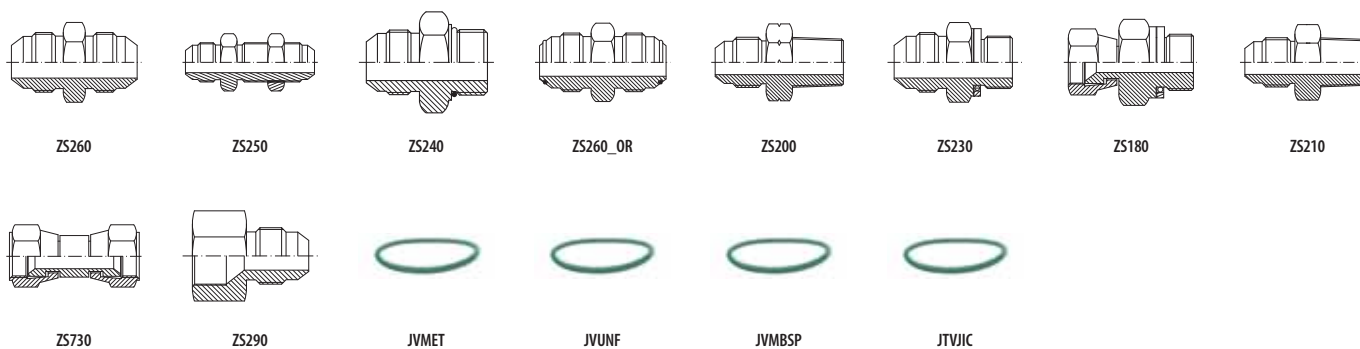

■ Codos 90 JIC 37° / JIC 37° 90° Elbows / Coudes 90° JIC 37° / Adattatori a 90° JIC 37°

| 124

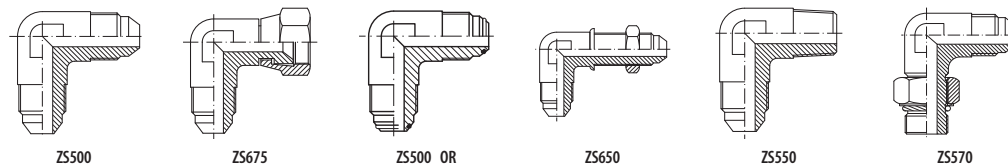

■ Codos 45 JIC 37° / JIC 37° 45° Elbows / Coudes 45° JIC 37° / Adattatori a 45° JIC 37°

| 125

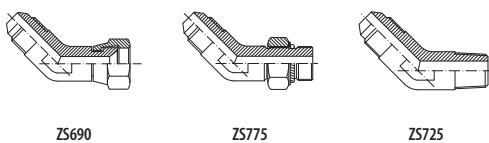

■ Tes JIC 37° / JIC 37° Tees / Tés JIC 37° / Adattatori a T JIC 37°

| 126

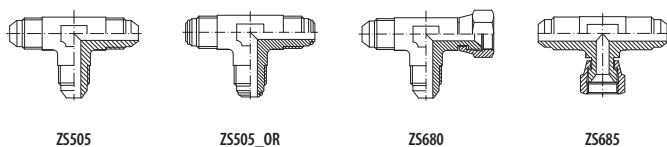

■ Racores JIC 37° - NPT / JIC 37° - NPT unions / Raccords JIC 37° - NPT / Adattatori JIC 37° - NPT

| 127

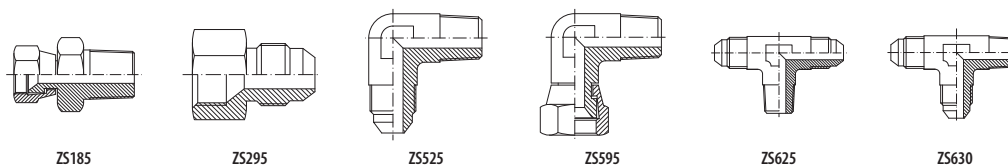

Bridas SAE

SAE Flanges
Brides SAE
Flange SAE

■ Bridas roscadas / Threaded flanges / Brides taraudées / Flange filettate

| 129

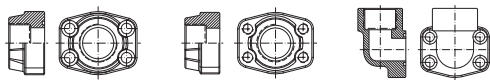

ZBBRG

ZBCRG

ZB90RG

■ Bridas soldables tubo gas / Welding flanges for gas tube / Brides à souder pour tube gaz / Flange a saldare per tubo gas

| 130

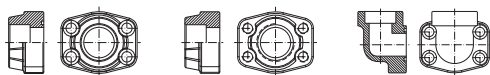

ZBBSG

ZBCSG

ZB90SG

■ Bridas soldables tubo Métrico / Welding flanges for metric tube / Brides à souder pour tube métrique / Flange a saldare per tubo Metrico

| 131

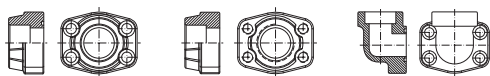

ZBBSM

ZBCSM

ZB90SM

■ Bridas ciegas / Blind flanges / Brides avec obturateur fermé / Flange cieche

| 132

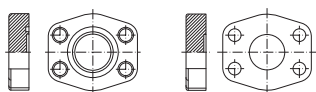

ZBBC

ZBCC

■ Bridas para flexibles / SAE Flanges for hoses / Brides SAE pour flexibles / Flange SAE per tubi flessibili

| 133

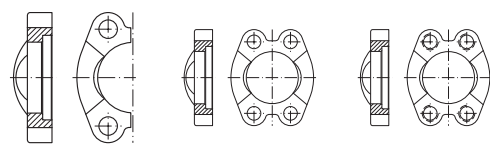

ZBBP

ZBBE

ZBCE

■ Conos soldar / Welding adaptors for flanges / Collets à souder / Ogive a saldare

| 134

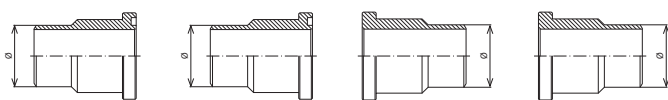

ZBSM*1

ZBSG*1

ZBSM*0

ZBSG*0

■ Accesorios bridas / Flange accessories / Accessoires pour brides / Accessori flangia

| 134



ZTB

JBR

Racores JIC 37°

Flare fittings JIC 37°
Raccords JIC 37°
Raccordi JIC 37°

Tuercas JIC 37°

Nut JIC 37°

Écrou JIC 37°

Dado JIC

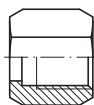

PIPE TUBO	THREAD ROSCA	Part nº Referencia	€
6	1/4	ZS11006	4,19
8	5/16	ZS11008	4,53
10	3/8	ZS11010	5,05
12	1/2	ZS11012	5,74
14-15-16	5/8	ZS11016	7,91
18-20	-	ZS11020	12,30
-	3/4	ZS11020W	13,58
25	1	ZS11025	19,57
30-32	1 1/4	ZS11032	25,36
38	1 1/2	ZS11038	44,84

Ferulas JIC 37° (tubo Métrico)

Tube sleeves Metric JIC 37°

Ferrules JIC 37° pour tube Métrique

Bussola JIC 37° per tubo Metrico

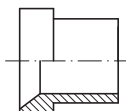

PIPE TUBO	Part nº Referencia	€
6	ZS12006	2,64
8	ZS12008	2,97
10	ZS12010	3,65
12	ZS12012	4,05
14	ZS12014	6,09
15	ZS12015	6,09
16	ZS12016	6,09
18	ZS12018	7,43
20	ZS12020	7,43
25	ZS12025	10,48
30	ZS12030	14,82
32	ZS12032	16,46
38	ZS12038	25,22

Ferulas JIC 37° (tubo Gas)

Tube sleeves Gas JIC 37°

Ferrules JIC 37° pour tube Gaz

Bussola JIC 37° per tubo gas

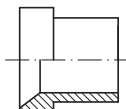

PIPE TUBO	Part nº Referencia	€
1/4"	ZS12104	3,38
5/16"	ZS12105	3,72
3/8"	ZS12106	4,40
1/2"	ZS12108	4,87
5/8"	ZS12110	4,87
3/4"	ZS12112	7,43
1"	ZS12116	17,41
1"1/4	ZS12120	22,11
1"1/2	ZS12124	31,11
2"	ZS12132	42,25

Tapón macho JIC 37°

Plug male JIC 37°

Bouchon mâle JIC 37°

Tappo maschio JIC 37°

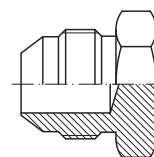

PIPE TUBO	THREAD ROSCA	Part nº Referencia	€
6	1/4	ZS14006	7,26
8	5/16	ZS14008	7,33
10	3/8	ZS14010	9,62
12	1/2	ZS14012	10,99
14-15-16	5/8	ZS14016	13,80
18-20	3/4	ZS14020	19,62
25	1	ZS14025	26,54
30-32	1 1/4	ZS14032	44,60
38	1 1/2	ZS14038	66,48

Tapón hembra giratoria JIC 37°

Plug female JIC 37°

Bouchon femelle JIC 37°

Tappo femmina girevole JIC 37°

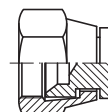

PIPE TUBO	THREAD ROSCA	Part nº Referencia	€
6	1/4	ZS13006	13,02
8	5/16	ZS13008	14,75
10	3/8	ZS13010	13,43
12	1/2	ZS13012	14,34
14-15-16	5/8	ZS13016	16,29
18-20	3/4	ZS13020	23,86
25	1	ZS13025	42,34
30-32	1 1/4	ZS13032	58,13
38	1 1/2	ZS13038	75,37

Tapón hembra fija JIC 37°

Plug female fixed JIC 37°

Bouchon femelle fixe JIC 37°

Tappo femmina fissa JIC

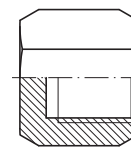

PIPE TUBO	THREAD ROSCA	Part nº Referencia	€
10	3/8	ZS13210	11,23
12	1/2	ZS13212	11,84
14-15-16	5/8	ZS13216	14,39
18-20	3/4	ZS13220	14,89
25	1	ZS13225	17,45

Hasta fin de existencias / Until end of stock / Jusqu'à fin du stock / Fino ad esaurimento scorta

Racores JIC 37°

Flare fittings JIC 37°

Raccords JIC 37°

Raccordi JIC 37°

Crimp fittings for hoses

Pipe fittings DIN 2353

Flare fittings JIC 37° / SAE Flanges

Adaptors

Welding fittings

Industrial fittings

Couplings, Ball valves and Hydraulic Components

Racor macho-macho JIC 37°

Straight union JIC 37°

Adapteur droit mâle JIC 37°

Niples di giunzione JIC

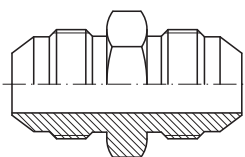

PIPE TUBO		THREAD ROSCA	Part n° Referencia	€
6	1/4	7/16" 20h UNF	ZS26006	11,20
8	5/16	1/2" 20h UNF	ZS26008	10,15
10	3/8	9/16" 18h UNF	ZS26010	10,20
12	1/2	3/4" 16h UNF	ZS26012	11,86
14-15-16	5/8	7/8" 14h UNF	ZS26016	16,75
18-20	3/4	1"1/16 12h UN	ZS26020	22,91
25	1	1"5/16 12h UN	ZS26025	29,61
30-32	1 1/4	1"5/8 12h UN	ZS26032	41,34
38	1 1/2	1"7/8 12h UN	ZS26038	63,25

Racor pasatabiques JIC 37°

Straight bulkhead fitting JIC 37°

Union passe cloison droite mâle JIC 37° équipé

Niples passaparete JIC

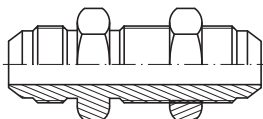

PIPE TUBO		THREAD ROSCA	Part n° Referencia	€
6	1/4	7/16" 20h UNF	ZS25006	19,59
8	5/16	1/2" 20h UNF	ZS25008	17,40
10	3/8	9/16" 18h UNF	ZS25010	20,53
12	1/2	3/4" 16h UNF	ZS25012	24,66
14-15-16	5/8	7/8" 14h UNF	ZS25016	33,80
18-20	3/4	1"1/16 12h UN	ZS25020	44,72
25	1	1"5/16 12h UN	ZS25025	65,05
30-32	1 1/4	1"5/8 12h UN	ZS25032	84,91
38	1 1/2	1"7/8 12h UN	ZS25038	124,95

Racor macho JIC 37° - macho Métrico

Metric adaptor male - male JIC 37°

Adapteur mâle JIC 37° - mâle Métrique

Niples di congiunzione maschio JIC 37° - maschio Metrico

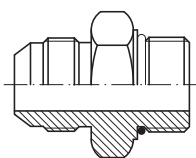

PIPE TUBO		THREAD ROSCA		Part n° Referencia	€
6	1/4	M10x1	7/16" 20h UNF	ZS2400610	18,10
8	5/16	M10x1	1/2" 20h UNF	ZS2400810 *	17,36
8	5/16	M12x1.5	1/2" 20h UNF	ZS2400812	16,48
8	5/16	M14x1.5	1/2" 20h UNF	ZS2400814 *	14,34
10	3/8	M14x1.5	9/16" 18h UNF	ZS2401014	20,80
10	3/8	M16x1.5	9/16" 18h UNF	ZS2401016	20,03
12	1/2	M14x1.5	3/4" 16h UNF	ZS2401214	23,04
12	1/2	M16x1.5	3/4" 16h UNF	ZS2401216	19,99
12	1/2	M18x1.5	3/4" 16h UNF	ZS2401218	20,47
14-15-16	5/8	M18x1.5	7/8" 14h UNF	ZS2401418	38,80
14-15-16	5/8	M27x2	7/8" 14h UNF	ZS2401427 *	23,02
14-15-16	5/8	M22x1.5	7/8" 14h UNF	ZS2401622	40,83
18-20	3/4	M22x1.5	1"1/16 12h UN	ZS2402022	40,83
18-20	3/4	M27X2	1"1/16 12h UN	ZS2402027	42,07
25	1	M27x2	1"5/16 12h UNF	ZS2402527 *	51,02
25	1	M33x2	1"5/16 12h UN	ZS2402533	52,49
30-32	1 1/4	M42x2	1"5/8 12h UN	ZS2403242	85,25
38	1 1/2	M50x2	1"7/8 12h UN	ZS2403850	129,35

*Hasta fin de existencias. / *Until end of stock. / *Jusqu'à la fin du stock. / *Fino ad esaurimento scorta.

Racor macho-macho JIC 37° con junta

Straight union JIC 37° with o'ring

Adapteur droit mâle JIC 37° avec o'ring

Niples di giunzione JIC con o'ring

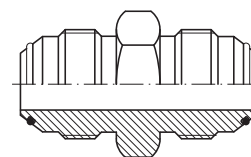

PIPE TUBO		THREAD ROSCA	Part n° Referencia	€
6	1/4	7/16" 20h UNF	ZS26006OR	17,24
8	5/16	1/2" 20h UNF	ZS26008OR	12,84
10	3/8	9/16" 18h UNF	ZS26010OR	17,58
12	1/2	3/4" 16h UNF	ZS26012OR	19,27
14-15-16	5/8	7/8" 14h UNF	ZS26016OR	26,89
18-20	3/4	1"1/16 12h UN	ZS26020OR	40,94
25	1	1"5/16 12h UN	ZS26025OR	52,04
30-32	1 1/4	1"5/8 12h UN	ZS26032OR	78,53
38	1 1/2	1"7/8 12h UN	ZS26038OR	120,62

Racor macho JIC 37° - macho NPT

Straight adaptor male JIC 37° - male NPT pipe

Adapteur mâle JIC 37° - male NPT (BRIGGS)

Niples di congiunzione JIC 37° - NPT

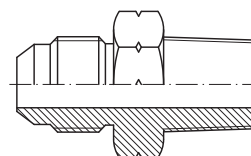

PIPE TUBO		THREAD ROSCA		Part n° Referencia	€
6	1/4	1/8" NPT	7/16" 20h UNF	ZS2000610	11,60
6	1/4	1/4" NPT	7/16" 20h UNF	ZS2000613	9,65
8	5/16	1/8" NPT	1/2" 20h UNF	ZS2000810	9,04
8	5/16	1/4" NPT	1/2" 20h UNF	ZS2000813	10,96
10	3/8	1/8" NPT	9/16" 18h UNF	ZS2001010	12,60
10	3/8	1/4" NPT	9/16" 18h UNF	ZS2001013	10,10
10	3/8	3/8" NPT	9/16" 18h UNF	ZS2001017	10,60
10	3/8	1/2" NPT	9/16" 18h UNF	ZS2001021	16,90
12	1/2	3/8" NPT	3/4" 16h UNF	ZS2001217	13,50
12	1/2	1/2" NPT	3/4" 16h UNF	ZS2001221	13,37
12	1/2	3/4" NPT	3/4" 16h UNF	ZS2001226	18,25
14-15-16	5/8	1/2" NPT	7/8" 14h UNF	ZS2001621	20,50
14-15-16	5/8	3/4" NPT	7/8" 14h UNF	ZS2001626	20,86
18-20	3/4	1/2" NPT	1"1/16 12h UN	ZS2002021	23,65
18-20	3/4	3/4" NPT	1"1/16 12h UN	ZS2002026	26,39
18-20	3/4	1" NPT	1"1/16 12h UN	ZS2002033	32,15
25	1	3/4" NPT	1"5/16 12h UN	ZS2002526	33,92
25	1	1" NPT	1"5/16 12h UN	ZS2002533	33,67
30-32	1	1"1/4 NPT	1"5/16 12h UN	ZS2002542	69,17
30-32	1 1/4	1" NPT	1"5/8 12h UN	ZS2003233	64,74
30-32	1 1/4	1 1/4" NPT	1"5/8 12h UN	ZS2003242	56,98
38	1 1/2	1 1/4" NPT	1"7/8 12h UN	ZS2003842	68,12
38	1 1/2	1 1/2" NPT	1"7/8 12h UN	ZS2003848	65,80

Racores JIC 37°

Flare fittings JIC 37°

Raccords JIC 37°

Raccordi JIC 37°

Racor macho JIC 37° - macho BSP

Straight adaptor male JIC 37° - male BSP

Adapteur mâle JIC 37° - mâle BSP équipé

Niples di congiunzione JIC - BSP

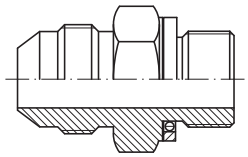

PIPE TUBO	THREAD ROSCA	Part n° Referencia	€
6	1/4	7/16" 20h UNF 1/8" BSP	ZS2300610 10,40
6	1/4	7/16" 20h UNF 1/4" BSP	ZS2300613 10,65
6	1/4	7/16" 20h UNF 3/8" BSP	ZS2300617 15,20
6	1/4	7/16" 20h UNF 1/2" BSP	ZS2300621 33,40
8	5/16	1/2" 20h UNF 1/4" BSP	ZS2300813 11,23
8	5/16	1/2" 20h UNF 3/8" BSP	ZS2300817 12,65
10	3/8	9/16" 18h UNF 1/4" BSP	ZS2301013 10,61
10	3/8	9/16" 18h UNF 3/8" BSP	ZS2301017 11,13
10	3/8	9/16" 18h UNF 1/2" BSP	ZS2301021 16,70
12	1/2	3/4" 16h UNF 1/4" BSP	ZS2301213 13,35
12	1/2	3/4" 16h UNF 3/8" BSP	ZS2301217 12,30
12	1/2	3/4" 16h UNF 1/2" BSP	ZS2301221 13,87
12	1/2	3/4" 16h UNF 3/4" BSP	ZS2301226 25,30
14-15-16	5/8	7/8" 14h UNF 3/8" BSP	ZS2301617 16,60
14-15-16	5/8	7/8" 14h UNF 1/2" BSP	ZS2301621 16,10
18-20	3/4	1" 1/16 12h UN 1/2" BSP	ZS2302021 21,90
18-20	3/4	1" 1/16 12h UN 3/4" BSP	ZS2302026 20,90
18-20	3/4	1" 1/16 12h UN 1" BSP	ZS2302033 43,87
25	1	1" 5/16 12h UN 1/2" BSP	ZS2302521 * 36,51
25	1	1" 5/16 12h UN 3/4" BSP	ZS2302526 32,51
25	1	1" 5/16 12h UN 1" BSP	ZS2302533 38,60
25	1	1" 5/16 12h UN 1" 1/4 BSP	ZS2302542 66,26
30-32	1	1" 5/8 12h UN 1" BSP	ZS2303233 * 72,58
30-32	1 1/4	1" 5/8 12h UN 1" 1/4 BSP	ZS2303242 71,82
38	1 1/2	1" 7/8 12h UN 1" 1/4 BSP	ZS2303842 87,07
38	1 1/2	1" 7/8 12h UN 1" 1/2 BSP	ZS2303848 106,10
38	2	1" 7/8 12h UN 2" BSP	ZS2303860 155,20

*Hasta fin de existencias. / *Until end of stock. / *Jusqu'à la fin du stock. / *Fino ad esaurimento scorta.

Racor macho BSP - hembra giratoria JIC 37°

Straight adaptor male BSP - swivel female JIC 37°

Adapteur mâle BSP - femelle tournante JIC 37°

Niples di congiunzione maschio BSP - femmina girevole JIC 37°

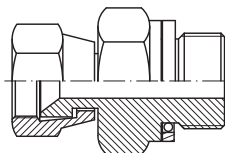

PIPE TUBO	THREAD ROSCA	Part n° Referencia	€
6	1/4	M 1/8" BSP F 7/16" 20h UNF	ZS1800610 16,99
8	5/16	M 1/4" BSP F 1/2" 20h UNF	ZS1800813 16,80
10	3/8	M 1/4" BSP F 9/16" 18h UNF	ZS1801013 16,32
10	3/8	M 3/8" BSP F 9/16" 18h UNF	ZS1801017 19,28
10	3/8	M 1/2" BSP F 9/16" 18h UNF	ZS1801021 22,56
12	1/2	M 3/8" BSP F 3/4" 16h UNF	ZS1801217 20,96
14-15-16	5/8	M 1/2" BSP F 7/8" 14h UNF	ZS1801621 26,19
18-20	3/4	M 3/4" BSP F 1" 1/16 12h UNF	ZS1802026 34,05
25	1	M 1" BSP F 1" 5/16 12h UNF	ZS1802533 62,62
30-32	1 1/4	M 1" 1/4 BSP F 1" 5/8 12h UNF	ZS1803242 104,17
38	1 1/2	M 1" 1/2 BSP F 1" 7/8 12h UNF	ZS1803848 151,71

Racor macho JIC 37° - macho BSPT

Straight adaptor male JIC 37° - male BSPT

Adapteur mâle JIC 37° - mâle BSPT

Niples di congiunzione JIC - BSPT

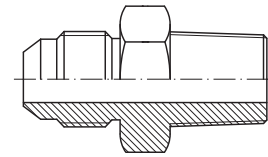

PIPE TUBO	THREAD ROSCA	Part n° Referencia	€
6	1/4	7/16" 20h UNF 1/8" BSPT	ZS2100610 10,36
6	1/4	7/16" 20h UNF 1/4" BSPT	ZS2100613 9,70
8	5/16	1/2" 20h UNF 1/8" BSPT	ZS2100810 9,60
8	5/16	1/2" 20h UNF 1/4" BSPT	ZS2100813 9,60
8	5/16	1/2" 20h UNF 3/8" BSPT	ZS2100817 13,03
10	3/8	9/16" 18h UNF 1/4" BSPT	ZS2101013 10,80
10	3/8	9/16" 18h UNF 3/8" BSPT	ZS2101017 12,30
10	3/8	9/16" 18h UNF 1/2" BSPT	ZS2101021 17,85
12	1/2	3/4" 16h UNF 1/4" BSPT	ZS2101213 14,15
12	1/2	3/4" 16h UNF 3/8" BSPT	ZS2101217 13,15
12	1/2	3/4" 16h UNF 1/2" BSPT	ZS2101221 14,20
14-15-16	5/8	7/8" 14h UNF 3/8" BSPT	ZS2101617 21,97
14-15-16	5/8	7/8" 14h UNF 1/2" BSPT	ZS2101621 19,39
14-15-16	5/8	7/8" 14h UNF 3/4" BSPT	ZS2101626 21,95
18-20	3/4	1" 1/16 12h UN 1/2" BSPT	ZS2102021 22,60
18-20	3/4	1" 1/16 12h UN 3/4" BSPT	ZS2102026 26,92
18-20	3/4	1" 1/16 12h UN 1" BSPT	ZS2102033 34,31
25	1	1" 5/16 12h UN 3/4" BSPT	ZS2102526 34,61
25	1	1" 5/16 12h UN 1" BSPT	ZS2102533 34,36
30-32	1 1/4	1" 5/8 12h UN 1" BSPT	ZS2103233 55,07
30-32	1 1/4	1" 5/8 12h UN 1 1/4" BSPT	ZS2103242 58,14
38	1 1/2	1" 7/8 12h UN 1 1/2" BSPT	ZS2103848 69,00

Racor hembra giratoria - hembra giratoria JIC 37°

Straight adaptor swivel female JIC 37°

Adapteur femelle tournante JIC 37°

Niples femmina - femmina girevole JIC

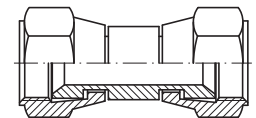

PIPE TUBO	THREAD ROSCA	Part n° Referencia	€
6	1/4	7/16" 20h UNF	ZS73006 17,50
8	5/16	1/2" 20h UNF	ZS73008 16,00
10	3/8	9/16" 18h UNF	ZS73010 20,89
12	1/2	3/4" 16h UNF	ZS73012 22,17
14-15-16	5/8	7/8" 14h UNF	ZS73016 30,29
18-20	3/4	1" 1/16 12h UN	ZS73020 44,90
25	1	1" 5/16 12h UN	ZS73025 63,08
32	1 1/4	1" 5/8 12h UN	ZS73032 115,23
38	1 1/2	1" 7/8 12h UN	ZS73038 139,72

Racores JIC 37°

Flare fittings JIC 37°

Raccords JIC 37°

Raccordi JIC 37°

Crimp fittings for hoses

Pipe fittings DIN 2353

Flare fittings JIC 37° / SAE Flanges

Adaptors

Welding fittings

Industrial fittings

Couplings, Ball valves and Hydraulic Components

Racor reducción macho - hembra JIC 37°

Reducer adaptor male JIC 37° - female JIC 37°

Adaptateur réduction mâle JIC 37° - femelle JIC 37°

Nipples di riduzione maschio - femmina JIC 37°

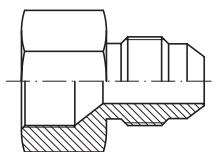

T.		THREAD ROSCA		Part n° Referencia	€
F 8	M 6	F 1/2" 20h UNF	M 7/16" 20h UNF	ZS2900608	*
F 12	M 6	F 3/4" 16h UNF	M 7/16" 20h UNF	ZS2900612	*
F 25	M 6	F 1"5/16" 12h UNF	M 7/16" 20h UNF	ZS2900625	*
F 14-15-16	M 8	F 7/8" 14h UNF	M 1/2" 20h UNF	ZS2900816	*
F 18-20	M 8	F 1"1/16" 12h UNF	M 1/2" 20h UNF	ZS2900820	*
F 25	M 8	F 1"5/16" 12h UNF	M 1/2" 20h UNF	ZS2900825	*
F 10	M 6	F 9/16" 18h UNF	M 7/16" 20h UNF	ZS2901006	16,30
F 10	M 8	F 9/16" 18h UNF	M 1/2" 20h UNF	ZS2901008	13,68
F 25	M 10	F 1"5/16" 12h UNF	M 9/16" 18h UNF	ZS2901025	*
F 12	M 6	F 3/4" 16h UNF	M 7/16" 20h UNF	ZS2901206	15,34
F 12	M 8	F 3/4" 16h UNF	M 1/2" 20h UNF	ZS2901208	18,04
F 12	M 10	F 3/4" 16h UNF	M 9/16" 18h UNF	ZS2901210	19,45
F 25	M 12	F 1"5/16" 12h UNF	M 3/4" 16h UNF	ZS2901225	*
F 30-32	M 12	F 1"5/8" 12h UNF	M 3/4" 16h UNF	ZS2901232	*
F 38	M 12	F 1"7/8" 12h UNF	M 3/4" 16h UNF	ZS2901238	*
F 14-15-16	M 6	F 7/8" 14h UNF	M 7/16" 20h UNF	ZS2901606	21,76
F 14-15-16	M 10	F 7/8" 14h UNF	M 9/16" 18h UNF	ZS2901610	24,43
F 14-15-16	M 12	F 7/8" 14h UNF	M 3/4" 16h UNF	ZS2901612	23,47
F 18-20	M 14-15-16	F 1"1/16" 12h UNF	M 7/8" 14h UNF	ZS2901620	*
F 25	M 14-15-16	F 1"5/16" 12h UNF	M 7/8" 14h UNF	ZS2901625	*
F 30-32	M 14-15-16	F 1"5/8" 14h UNF	M 7/8" 14h UNF	ZS2901632	*
F 38	M 14-15-16	F 1"7/8" 12h UNF	M 7/8" 14h UNF	ZS2901638	*
F 18-20	M 6	F 1"1/16 12h UN	M 7/16" 20h UNF	ZS2902006	34,52
F 18-20	M 10	F 1"1/16 12h UN	M 9/16" 18h UNF	ZS2902010	29,74
F 18-20	M 12	F 1"1/16 12h UN	M 3/4" 16h UNF	ZS2902012	27,82
F 30-32	M 18-20	F 1"5/8" 12h UNF	M 1"1/16" 12h UNF	ZS2902032	*
F 25	M 18-20	F 1"5/16 12h UN	M 1"1/16 12h UN	ZS2902520	50,08
F 38	M 25	F 1"7/8 12h UN	M 1"5/16 12h UN	ZS2902538	*
F 30-32	M 18-20	F 1"5/8 12h UN	M 1"1/16 12h UN	ZS2903020	61,62
F 30-32	M 25	F 1"5/8 12h UN	M 1"5/16 12h UN	ZS2903225	63,66
F 38	30-32	F 1"7/8 12h UN	M 1"5/8 12h UN	ZS2903832	123,86

Racores JIC 37°

Flare fittings JIC 37°
Raccords JIC 37°
Raccordi JIC 37°

Juntas tóricas FKM verde para macho MÉTRICO

O'ring FKM green for Metric thread

Joint torique FKM vert pour filetage métrique



Guarnizione FKM verde per maschio metrico

THREAD ROSCA	Part nº Referencia	€
M10x1	JVMET10	0,23
M12x1.5	JVMET12	0,31
M14x1.5	JVMET14	0,31
M16x1.5	JVMET16	0,36
M18x1.5	JVMET18	0,44
M22x1.5	JVMET22	0,52
M27x2	JVMET27	0,68
M33x2	JVMET33	1,64
M42x2	JVMET42	3,11
M50x2	JVMET50	1,44

Juntas tóricas FKM verde para rosca UNF

O'ring FKM green for UNF thread

Joint torique FKM vert pour filetage UNF



Guarnizione FKM verde per filetto UNF

THREAD ROSCA	Part nº Referencia	€
7/16" UNF	JVUNF06	*
1/2" UNF	JVUNF08	*
9/16" UNF	JVUNF10	*
3/4" UNF	JVUNF12	*
7/8" UNF	JVUNF16	*
1" 1/16 UNF	JVUNF20	*
1"5/16 UNF	JVUNF25	*
1" 5/8 UNF	JVUNF32	*
1" 7/8 UNF	JVUNF38	*

Codo 90° macho - macho JIC 37°

90° Elbow male - male JIC 37°

Coude 90° mâle - mâle JIC 37°

Adattatore a 90° maschio - maschio JIC 37°

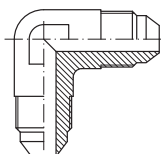

PIPE TUBO	THREAD ROSCA	Part nº Referencia	€
6	1/4	ZS50006	25,72
8	5/16	ZS50008	27,34
10	3/8	ZS50010	24,80
12	1/2	ZS50012	42,80
14-15-16	5/8	ZS50016	52,10
18-20	3/4	ZS50020	61,40
25	1	ZS50025	81,50
30-32	1 1/4	ZS50032	111,06
38	1 1/2	ZS50038	191,72

Juntas tóricas FKM verde para macho BSP

O'ring FKM green for BSP thread

Joint torique FKM vert pour mâle BSP



Guarnizione FKM verde per maschio BSP

THREAD ROSCA	Part nº Referencia	€
1/8" BSP	JVMBSP02	0,26
1/4" BSP	JVMBSP04	0,34
3/8" BSP	JVMBSP06	0,42
1/2" BSP	JVMBSP08	0,54
3/4" BSP	JVMBSP12	0,68
1" BSP	JVMBSP16	1,44
1"1/4 BSP	JVMBSP20	1,82
1"1/2 BSP	JVMBSP24	2,13
2" BSP	JVMBSP32	3,16

Juntas para Macho JIC FKM verde

O'ring FKM green for JIC Male thread

Joint FKM vert pour mâle JIC



Guarnizione per maschio JIC FKM verde

THREAD ROSCA	Part nº Referencia	€
7/16" 20h UNF	JTVJIC07	0,16
9/16" 18h UNF	JTVJIC09	0,16
3/4" 16h UNF	JTVJIC12	0,17
1"1/16 12h UNF	JTVJIC17	0,19
1"5/8 12h UNF	JTVJIC26	0,32

Codo 90° macho JIC 37° - hembra giratoria JIC 37°

90° Elbow swivel female JIC 37° - male JIC 37°

Coude 90° mâle JIC 37° - femelle tournante JIC 37°

Adattatore a 90° maschio JIC 37° - femmina girevole JIC 37°

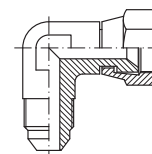

T.	THREAD ROSCA	Part nº Referencia	€
6	1/4	M 7/16" 20h UNF F 7/16" 20h UNF	ZS67506 26,60
8	5/16	M 1/2" 20h UNF F 1/2" 20h UNF	ZS67508 30,66
10	3/8	M 9/16" 18h UNF F 9/16" 18h UNF	ZS67510 29,38
12	1/2	M 3/4" 16h UNF F 3/4" 16h UNF	ZS67512 40,10
14-15-16	5/8	M 7/8" 14h UNF F 7/8" 14h UNF	ZS67516 54,17
18-20	3/4	M 1"1/16 12h UNF F 1"1/16 12h UNF	ZS67520 68,33
25	1	M 1"5/16 12h UNF F 1"5/16 12h UNF	ZS67525 102,40
30-32	1 1/4	M 1"5/8 12h UNF F 1"5/8 12h UNF	ZS67532 142,47
38	1 1/2	M 1"7/8 12h UNF F 1"7/8 12h UNF	ZS67538 212,14

Racores JIC 37°

Flare fittings JIC 37°

Raccords JIC 37°

Raccordi JIC 37°

Crimp fittings for hoses

Pipe fittings DIN 2353

Flare fittings JIC 37° / SAE Flanges

Adaptors

Welding fittings

Industrial fittings

Couplings, Ball valves and Hydraulic Components

Codo 90° macho - macho JIC 37° con junta

90° Elbow male - male JIC 37° with o'ring

Coude 90° mâle - mâle JIC 37° avec o'ring

Adattatore a 90° maschio - maschio JIC 37° con o'ring

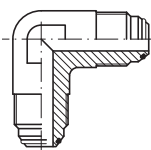

PIPE TUBO		THREAD ROSCA		Part n° Referencia	€
6	1/4	7/16" 20h UNF		ZS50006OR	34,91
8	5/16	1/2" 20h UNF		ZS50008OR	36,61
10	3/8	9/16" 18h UNF		ZS50010OR	38,30
12	1/2	3/4" 16h UNF		ZS50012OR	47,85
14-15-16	5/8	7/8" 14h UNF		ZS50016OR	67,80
18-20	3/4	1"1/16 12h UN		ZS50020OR	91,28
25	1	1"5/16 12h UN		ZS50025OR	132,07
30-32	1 1/4	1"5/8 12h UN		ZS50032OR	162,29
38	1 1/2	1"7/8 12h UN		ZS50038OR	280,16

Codo 90° pasatabiques macho - macho JIC 37°

90° Bulkhead elbow male - male JIC 37°

Coude 90° passe cloison mâle - mâle JIC 37°

Adattatore a 90° passaparete maschio - maschio JIC 37°

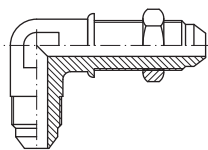

PIPE TUBO		THREAD ROSCA		Part n° Referencia	€
6	1/4	7/16 - 20h UNF	7/16 - 20h UNF	ZS65006	65,51
8	5/16	1/2 - 20h UNF	1/2 - 20h UNF	ZS65008	77,32
10	3/8	9/16 - 18h UNF	9/16 - 18h UNF	ZS65010	76,03
12	1/2	3/4 - 16h UNF	3/4 - 16h UNF	ZS65012	92,24
14-15-16	5/8	7/8 - 14h UNF	7/8 - 14h UNF	ZS65016	114,17
18-20	3/4	1 1/16 - 12h UN	1 1/16 - 12h UN	ZS65020	168,04
25	1	1 5/16 - 12h UN	1 5/16 - 12h UN	ZS65025	200,08

Codo 45° macho JIC 37° - hembra giratoria JIC 37°

45° Elbow male JIC 37° - swivel female JIC 37°

Coude 45° mâle JIC 37° - femelle tournante JIC 37°

Adattatore a 45° maschio JIC 37° - femmina girevole JIC 37°

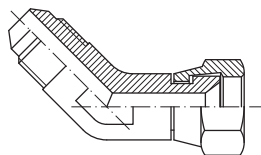

PIPE TUBO		THREAD ROSCA		Part n° Referencia	€
6	1/4	M 7/16" 20h UNF	F 7/16" 20h UNF	ZS69006	17,39
8	5/16	M 1/2" 20h UNF	F 1/2" 20h UNF	ZS69008	20,46
10	3/8	M 9/16" 18h UNF	F 9/16" 18h UNF	ZS69010	22,48
12	1/2	M 3/4" 16h UNF	F 3/4" 16h UNF	ZS69012	40,45
14-15-16	5/8	M 7/8" 14h UNF	F 7/8" 14h UNF	ZS69016	50,41
18-20	3/4	M 1"1/16 12h UN	F 1"1/16 12h UN	ZS69020	299,78
25	1	M 1"5/16 12h UN	F 1"5/16 12h UN	ZS69025	429,67

Codo 90° macho JIC 37° - macho BSPT

90° Elbow male JIC 37° - male BSPT

Coude 90° mâle JIC 37° - mâle BSPT

Adattatore a 90° maschio JIC 37° - maschio BSPT

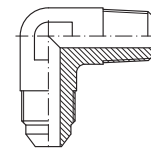

PIPE TUBO		THREAD ROSCA		Part n° Referencia	€
6	1/4	1/8" BSPT	7/16" 20h UNF	ZS5500610	34,62
6	1/4	1/4" BSPT	7/16" 20h UNF	ZS5500613	35,30
8	5/16	1/8" BSPT	1/2" 20h UNF	ZS5500810	36,90
8	5/16	1/4" BSPT	1/2" 20h UNF	ZS5500813	33,73
10	3/8	1/4" BSPT	9/16" 18h UNF	ZS5501013	26,02
10	3/8	3/8" BSPT	9/16" 18h UNF	ZS5501017	41,97
10	3/8	1/2" BSPT	9/16" 18h UNF	ZS5501021	41,44
12	1/2	1/4" BSPT	3/4" 16h UNF	ZS5501213	47,19
12	1/2	3/8" BSPT	3/4" 16h UNF	ZS5501217	46,75
12	1/2	1/2" BSPT	3/4" 16h UNF	ZS5501221	40,02
14-15-16	5/8	3/8" BSPT	7/8" 14h UNF	ZS5501617	54,79
14-15-16	5/8	1/2" BSPT	7/8" 14h UNF	ZS5501621	61,61
14-15-16	5/8	3/4" BSPT	7/8" 14h UNF	ZS5501626	108,75
18-20	3/4	1/2" BSPT	1"1/16 12h UN	ZS5502021	71,44
18-20	3/4	3/4" BSPT	1"1/16 12h UN	ZS5502026	76,20
25	1	3/4" BSPT	1"5/16 12h UN	ZS5502526	130,57
25	1	1" BSPT	1"5/16 12h UN	ZS5502533	93,38
30-32	1 1/4	1 1/4" BSPT	1"5/8 12h UN	ZS5503242 *	217,55

*Hasta fin de existencias. / *Until end of stock. / *Jusqu'à la fin du stock. / *Fino ad esaurimento scorta.

Codo 90° regulable macho JIC 37° - macho BSP

90° Adjustable stud elbow male JIC 37° - male BSP

Coude 90° orientable mâle JIC 37° - mâle BSP

Adattatore a 90° orientabile maschio JIC 37° - maschio BSP

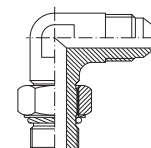

PIPE TUBO		THREAD ROSCA		Part n° Referencia	€
6	1/4	7/16" 20h UNF	1/4" BSP	ZS5700613	22,12
10	3/8	9/16" 18h UNF	3/8" BSP	ZS5701017	34,00
12	1/2	3/4" 16h UNF	1/2" BSP	ZS5701221	50,41
14-15-16	5/8	7/8" 14h UNF	1/2" BSP	ZS5701621	57,13
18-20	3/4	1"1/16 12h UN	3/4" BSP	ZS5702026	83,30
25	1	1"5/16 12h UN	1" BSP	ZS5702533	126,62
38	1 1/2	1"7/8 12h UN	1"1/2 BSP	ZS5703848	*

Codo 45° regulable macho - macho JIC 37°

45° Adjustable stud elbow male - male JIC 37°

Coude 45° orientable mâle - mâle JIC 37°

Adattatore a 45° orientabile maschio - maschio JIC 37°

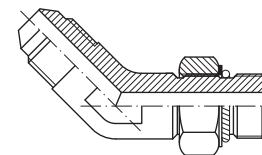

PIPE TUBO		THREAD ROSCA		Part n° Referencia	€
6	1/4	7/16 - 20h UNF	7/16 - 20h UNF	ZS77506	71,32
8	5/16	1/2 - 20h UNF	1/2 - 20h UNF	ZS77508	73,80
10	3/8	9/16 - 18h UNF	9/16 - 18h UNF	ZS77510	65,15
12	1/2	3/4 - 16h UNF	3/4 - 16h UNF	ZS77512	84,41
14-15-16	5/8	7/8 - 14h UNF	7/8 - 14h UNF	ZS77516	153,98
18-20	3/4	1 1/16 - 12h UN	1 1/16 - 12h UN	ZS77520	320,53
25	1	1 5/16 - 12h UN	1 5/16 - 12h UN	ZS77525	415,30

Racores JIC 37°

Flare fittings JIC 37°

Raccords JIC 37°

Raccordi JIC 37°

Codo 45° macho JIC 37° - macho NPT

45° Elbow male JIC 37° - male NPT pipe

Coude 45° mâle JIC 37° - mâle NPT

Adattatore a 45° maschio JIC 37° - maschio NPT

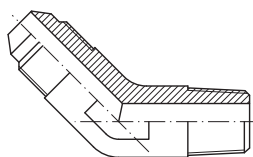

PIPE TUBO	THREAD ROSCA	Part n° Referencia	€
6	1/4 1/4" NPT	ZS7250613	15,76
10	3/8 3/8" NPT	ZS7251017	21,32
12	1/2 1/2" NPT	ZS7251221	32,44
18-20	3/4 3/4" NPT	ZS7252026	50,41
25	1 1" NPT	ZS7252533	83,76

TE macho - macho - macho JIC 37°

Union tee male JIC 37°

Té égaux mâle JIC 37°

Adattatore a T maschio JIC 37°

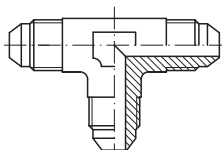

PIPE TUBO	THREAD ROSCA	Part n° Referencia	€
6	1/4 7/16" 20h UNF	ZS50506	34,10
8	5/16 1/2" 20h UNF	ZS50508	39,47
10	3/8 9/16" 18h UNF	ZS50510	34,77
12	1/2 3/4" 16h UNF	ZS50512	57,50
14-15-16	5/8 7/8" 14h UNF	ZS50516	63,86
18-20	3/4 1"1/16 12h UN	ZS50520	82,80
25	1 1"5/16 12h UN	ZS50525	114,50
30-32	1 1/4 1"5/8 12h UN	ZS50532	187,44
38	1 1/2 1"7/8 12h UN	ZS50538	288,16

TE macho - macho - macho JIC 37° con junta

Union tee male JIC 37° with o'ring

Té égaux mâle JIC 37° avec o'ring

Adattatore a T maschio JIC 37° con o'ring

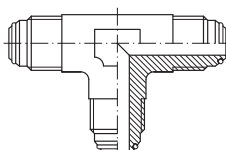

PIPE TUBO	THREAD ROSCA	Part n° Referencia	€
6	1/4 7/16" 20h UNF	ZS50506OR	50,14
8	5/16 1/2" 20h UNF	ZS50508OR	50,85
10	3/8 9/16" 18h UNF	ZS50510OR	56,39
12	1/2 3/4" 16h UNF	ZS50512OR	66,93
14-15-16	5/8 7/8" 14h UNF	ZS50516OR	82,08
18-20	3/4 1"1/16 12h UN	ZS50520OR	114,67
25	1 1"5/16 12h UN	ZS50525OR	172,12
30-32	1 1/4 1"5/8 12h UN	ZS50532OR	214,22
38	1 1/2 1"7/8 12h UN	ZS50538OR	327,37

TE macho - macho - hembra giratoria JIC 37°

Tee male JIC 37° - male JIC 37° - swivel nut JIC 37°

Té mâle JIC 37° - mâle JIC 37° - femelle tournante JIC 37° au latéral

Adattatore a T maschio - maschio - femmina girevole JIC 37°

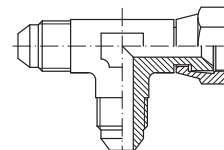

PIPE TUBO	THREAD ROSCA	Part n° Referencia	€
6	1/4 7/16" 20h UNF	ZS68006	34,93
8	5/16 1/2" 20h UNF	ZS68008	38,90
10	3/8 9/16" 18h UNF	ZS68010	40,00
12	1/2 3/4" 16h UNF	ZS68012	58,30
14-15-16	5/8 7/8" 14h UNF	ZS68016	67,98
18-20	3/4 1"1/16 12h UN	ZS68020	90,07
25	1 1"5/16 12h UN	ZS68025	127,10
32	1 1/4 1"5/8 12h UN	ZS68032	200,20
38	1 1/2 1"7/8 12h UN	ZS68038	267,17

TE macho - hembra giratoria - macho JIC 37°

Tee male JIC 37° - swivel nut JIC 37° - male JIC 37°

Té mâle JIC 37° - femelle tournante JIC 37° - mâle JIC 37°

Adattatore a T maschio - femmina girevole - maschio JIC 37°

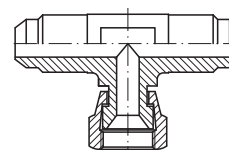

PIPE TUBO	THREAD ROSCA	Part n° Referencia	€
6	1/4 7/16" 20h UNF	ZS68506	46,00
8	5/16 1/2" 20h UNF	ZS68508	46,94
10	3/8 9/16" 18h UNF	ZS68510	39,60
12	1/2 3/4" 16h UNF	ZS68512	55,12
14-15-16	5/8 7/8" 14h UNF	ZS68516	67,84
18-20	3/4 1"1/16 12h UN	ZS68520	81,87
25	1 1"5/16 12h UN	ZS68525	159,87
32	1 1/4 1"5/8 12h UN	ZS68532	199,19
38	1 1/2 1"7/8 12h UN	ZS68538	267,17

Racores JIC 37°

Flare fittings JIC 37°

Raccords JIC 37°

Raccordi JIC 37°

Crimp fittings for hoses

Pipe fittings DIN 2353

Flare fittings JIC 37° / SAE Flanges

Adaptors

Welding fittings

Industrial fittings

Couplings, Ball valves and Hydraulic Components

Hembra giratoria JIC 37° - macho NPT

Straight adaptor swivel female JIC 37° - male NPT pipe

Adapteur femelle tournante JIC 37° - mâle NPT

Nipples femmina girevole JIC 37° - maschio NPT

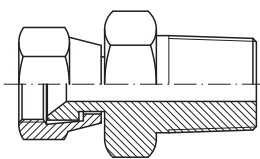

DN	THREAD ROSCA	Part n° Referencia	€
7/16" JIC	1/4" NPT	ZS1850613	*
9/16" JIC	3/8" NPT	ZS1851017	*
3/4" JIC	1/2" NPT	ZS1851221	*
1" 1/16 JIC	3/4" NPT	ZS1852026	*
1" 5/16 JIC	1" NPT	ZS1852533	*

Racor macho JIC 37° - hembra fija NPT

Straight adaptor male JIC 37° - fixed female NPT

Adapteur mâle JIC 37° - femelle fixe NPT

Nipples di congiunzione maschio JIC 37° - femmina fissa NPT

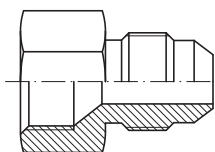

PIPE TUBO	THREAD ROSCA	Part n° Referencia	€
6 1/4	M 7/16"-20h UN F 1/4" NPT	ZS2950613	21,63
10 3/8	M 9/16"-18h UNF F 3/8" NPT	ZS2951017	30,37
12 1/2	M 3/4"-16h UNF F 1/2" NPT	ZS2951221	31,90
18-20 3/4	M 1"1/16-12h UN F 3/4" NPT	ZS2952026	39,80
25 1	M 1"5/16-12 UN F 1" NPT	ZS2952533	54,66

Codo 90° macho JIC 37° - macho NPT

90° Elbow male JIC 37° - male NPT

Coude 90° mâle JIC 37° - mâle NPT

Adattatore a 90° maschio JIC 37° - maschio NPT

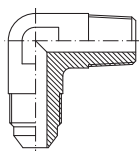

PIPE TUBO	THREAD ROSCA	Part n° Referencia	€
6 1/4	1/8" NPT 7/16" 20h UNF	ZS5250610	29,90
6 1/4	1/4" NPT 7/16" 20h UNF	ZS5250613	29,90
8 5/16	1/8" NPT 1/2" 20h UNF	ZS5250810	28,95
8 5/16	1/4" NPT 1/2" 20h UNF	ZS5250813	27,69
10 3/8	1/4" NPT 9/16" 18h UNF	ZS5251013	25,73
10 3/8	3/8" NPT 9/16" 18h UNF	ZS5251017	31,90
10 3/8	1/2" NPT 9/16" 18h UNF	ZS5251021	43,51
12 1/2	1/4" NPT 3/4" 16h UNF	ZS5251213	39,30
12 1/2	3/8" NPT 3/4" 16h UNF	ZS5251217	39,80
12 1/2	1/2" NPT 3/4" 16h UNF	ZS5251221	40,43
14-15-16 5/8	3/8" NPT 7/8" 14h UNF	ZS5251617	56,56
14-15-16 5/8	1/2" NPT 7/8" 14h UNF	ZS5251621	42,12
14-15-16 5/8	3/4" NPT 7/8" 14h UNF	ZS5251626	62,69
18-20 3/4	1/2" NPT 1"1/16 12h UN	ZS5252021	70,74
18-20 3/4	3/4" NPT 1"1/16 12h UN	ZS5252026	56,79
25 1	3/4" NPT 1"5/16 12h UN	ZS5252526	86,70
25 1	1" NPT 1"5/16 12h UN	ZS5252533	75,80

Codo 90° macho NPT - hembra giratoria JIC 37°

90° Elbow male NPT - swivel female JIC 37°

Coude 90° mâle NPT - femelle tournante JIC 37°

Adattatore a 90° maschio NPT - femmina girevole JIC 37°

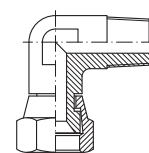

THREAD ROSCA	Part n° Referencia	€
1/8" NPT 7/16"-20h UNF	ZS5950610	28,55
1/4" NPT 1/2"-20h UNF	ZS5950813	31,49
1/4" NPT 9/16"-18h UNF	ZS5951013	32,32
3/8" NPT 3/4"-16h UNF	ZS5951217	42,76
1/2" NPT 7/8"-14h UNF	ZS5951621	58,37
3/4" NPT 1"1/16"-12h UN	ZS5952026	74,16
1" NPT 1"5/16"-12h UN	ZS5952533	110,08

TES macho JIC 37° - macho NPT - macho JIC 37°

Tee male JIC 37° - male NPT - male JIC 37°

Tés mâle JIC 37° - mâle NPT - mâle JIC 37°

Adattatore a T maschio JIC 37° - maschio NPT - maschio JIC 37°

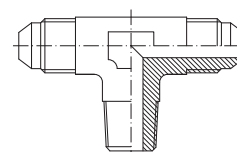

THREAD ROSCA	Part n° Referencia	€
7/16"-20h UNF 1/8" NPT 7/16"-20h UNF	ZS6250610	32,25
1/2"-20h UNF 1/4" NPT 1/2"-20h UNF	ZS6250813	43,42
9/16"-18h UNF 1/4" NPT 9/16"-18h UNF	ZS6251013	50,23
3/4"-16h UNF 3/8" NPT 3/4"-16h UNF	ZS6251217	59,07
7/8"-14h UNF 1/2" NPT 7/8"-14h UNF	ZS6251621	70,25
1"1/16-12h UN 3/4" NPT 1"1/16-12h UN	ZS6252026	97,34
1"5/16-12h UN 1" NPT 1"5/16-12h UN	ZS6252533	116,60

TES macho JIC 37° - macho JIC 37° - macho NPT

Tee male JIC 37° - male JIC 37° - male NPT

Tés mâle JIC 37° - mâle JIC 37° - mâle NPT

Adattatore a T maschio JIC 37° - maschio JIC 37° - maschio NPT

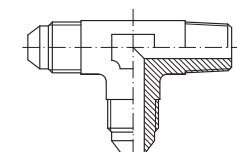

THREAD ROSCA	Part n° Referencia	€
7/16"-20h UNF 7/16"-20h UNF 1/8" NPT	ZS6300610	32,25
1/2"-20h UNF 1/2"-20h UNF 1/4" NPT	ZS6300813	43,42
9/16"-18h UNF 9/16"-18h UNF 1/4" NPT	ZS6301013	50,23
3/4"-16h UNF 3/4"-16h UNF 3/8" NPT	ZS6301217	59,07
7/8"-14h UNF 7/8"-14h UNF 1/2" NPT	ZS6301621	70,25
1"1/16-12h UN 1"1/16-12h UN 3/4" NPT	ZS6302026	97,34
1"5/16-12h UN 1"5/16-12h UN 1" NPT	ZS6302533	116,60

Bridas SAE

SAE flanges
Brides SAE
Flangia SAE

Características comunes

Common characteristics
Données communes
Caratteristiche comuni

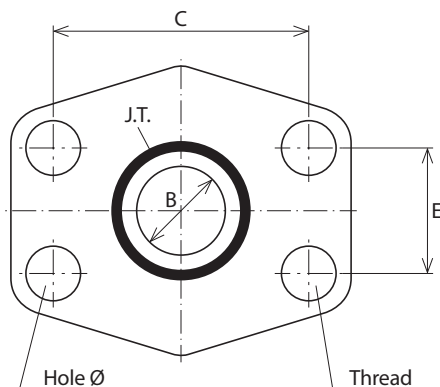

Bridas 3000 PSI

Flanges 3000 PSI
Brides 3000 PSI
Flangia 3000 PSI

Tamaño Size Taille Misura	Max. pre. Max. pre. Max. pre.	B	C	E	O'ring NBR O'ring NBR O'ring NBR O'ring NBR	Junta PU PU seal Joint PU Guarnizione in PU	Ø	Tornillo * Screw * Vis * Vite *	Rosca Thread Filetage Filetto
1/2"	345 bar	13	38,1	17,48	18,64 x 3,53	JBR08	9	TB8X30	M8
3/4"	345 bar	19	47,63	22,23	24,99 x 3,53	JBR12	11	TB10X35	M10
1"	345 bar	25	52,37	26,19	32,92 x 3,53	JBR16	11	TB10X35	M10
1 1/4"	276 bar	32	58,72	30,18	37,70 x 3,53	JBR20	11,5	TB10X40	M10
1 1/2"	207 bar	38	69,85	35,71	47,22 x 3,53	JBR24	13,5	TB12X45	M12
2"	207 bar	51	77,77	42,88	56,74 x 3,53	JBR32	13,5	TB12X45	M12
2 1/2"	172 bar	63	88,9	50,8	66,27 x 3,53		13,5	TB12X45	M12
3"	138 bar	73	106,38	61,93	85,32 x 3,53		17,5	TB16X50	M16
3 1/2"	34 bar	89	120,65	69,85	98,02 x 3,53		17,5	TB16X50	M16
4"	34 bar	99	130,18	77,77	110,72 x 3,53		17,5	TB16X50	M16

Bridas 6000 PSI

Flanges 6000 PSI
Brides 6000 PSI
Flangia 6000 PSI

Tamaño Size Taille Misura	Max. pre. Max. pre. Max. pre.	B	C	E	O'ring NBR O'ring NBR O'ring NBR O'ring NBR	Junta PU PU seal Joint PU Guarnizione PU	Ø	Tornillo * Screw * Vis * Vite *	Rosca Thread Filetage Filetto
1/2"	414 bar	13	40,49	18,24	18,64 x 3,53	JBR08	9	TB8X30	M8
3/4"	414 bar	19	50,8	23,8	24,99 x 3,53	JBR12	11	TB10X40	M10
1"	414 bar	25	57,15	27,76	32,92 x 3,53	JBR16	13	TB12X45	M12
1 1/4"	414 bar	32	66,68	31,75	37,70 x 3,53	JBR20	15	TB14X45	M14
1 1/2"	414 bar	38	79,38	36,5	47,22 x 3,53	JBR24	17	TB16X50	M16
2"	414 bar	51	98,82	44,45	56,74 x 3,53	JBR32	21	TB20X70	M20

* Tornillos en acero carbono. Para tornillos en acero inoxidable, pedir ZTB...

Screws are in carbon steel. For Stainless Steel screws, ask for ZTB... part number.
Les vis sont en acier carbone. Pour vis en acier inoxydable, veuillez demander les références ZTB ...
Le viti sono in acciaio al carbonio. Per viti in acciaio inox, ordinare con codice ZTB...

Bridas SAE

SAE Flanges
Brides SAE
Flange SAE

Crimp fittings for hoses

Pipe fittings DIN 2353

Flare fittings JIC 37° / SAE Flanges

Adaptors

Welding fittings

Industrial fittings

Couplings, Ball valves and Hydraulic Components

Brida roscada Hembra BSP

BSP Female threaded flange

Bride taraudée femelle BSP

Flangia filettata femmina BSP

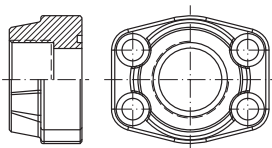

SERIE	THREAD ROSCA	SIZE TAMAÑO	Part nº Referencia	€
3000 PSI	1/2" BSP	1/2"	ZBBRG30808	52,97
3000 PSI	3/4" BSP	3/4"	ZBBRG31212	58,44
3000 PSI	1" BSP	1"	ZBBRG31616	66,47
3000 PSI	1"1/4 BSP	1"1/4	ZBBRG32020	75,56
3000 PSI	1"1/2 BSP	1"1/2	ZBBRG32424	102,60
3000 PSI	2" BSP	2"	ZBBRG33232	121,43
3000 PSI	2"1/2 BSP	2"1/2	ZBBRG34040	150,17
3000 PSI	3" BSP	3"	ZBBRG34848	156,87
3000 PSI	3"1/2 BSP	3"1/2	ZBBRG35656	572,73
3000 PSI	4" BSP	4"	ZBBRG36464	619,16
6000 PSI	1/2" BSP	1/2"	ZBBRG60808	54,06
6000 PSI	3/4" BSP	3/4"	ZBBRG61212	62,81
6000 PSI	1" BSP	1"	ZBBRG61616	76,13
6000 PSI	1"1/4 BSP	1"1/4	ZBBRG62020	95,58
6000 PSI	1"1/2 BSP	1"1/2	ZBBRG62424	116,05
6000 PSI	2" BSP	2"	ZBBRG63232	182,23

Brida codo 90° roscada Hembra BSP

90° BSP female threaded flange

Bride 90° taraudée femelle BSP

Flangia a 90° filettata femmina BSP

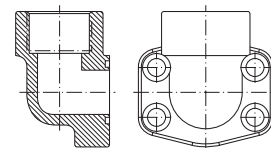

SERIE	THREAD ROSCA	SIZE TAMAÑO	Part nº Referencia	€
3000 PSI	1/2" BSP	1/2"	ZB90RG30808	112,67
3000 PSI	3/4" BSP	3/4"	ZB90RG31212	134,93
3000 PSI	1" BSP	1"	ZB90RG31616	161,08
3000 PSI	1"1/4 BSP	1"1/4	ZB90RG32020	193,35
3000 PSI	1"1/2 BSP	1"1/2	ZB90RG32424	377,68
3000 PSI	2" BSP	2"	ZB90RG33232	495,34
6000 PSI	1/2" BSP	1/2"	ZB90RG60808	112,67
6000 PSI	3/4" BSP	3/4"	ZB90RG61212	161,08
6000 PSI	1" BSP	1"	ZB90RG61616	193,35
6000 PSI	1"1/4 BSP	1"1/4	ZB90RG62020	264,29
6000 PSI	1"1/2 BSP	1"1/2	ZB90RG62424	347,75

Contrabrida roscada Hembra BSP

BSP Female threaded counter-flange

Contre-bride taraudée femelle BSP

Controflangia filettata femmina BSP

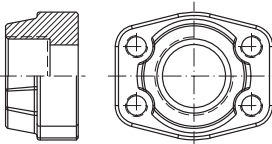

SERIE	THREAD ROSCA	SIZE TAMAÑO	Part nº Referencia	€
3000 PSI	1/2" BSP	1/2"	ZBCRG30808	48,10
3000 PSI	3/4" BSP	3/4"	ZBCRG31212	53,46
3000 PSI	1" BSP	1"	ZBCRG31616	61,24
3000 PSI	1"1/4 BSP	1"1/4	ZBCRG32020	69,59
3000 PSI	1"1/2 BSP	1"1/2	ZBCRG32424	96,85
3000 PSI	2" BSP	2"	ZBCRG33232	115,83
3000 PSI	2"1/2 BSP	2"1/2	ZBCRG34040	144,57
3000 PSI	3" BSP	3"	ZBCRG34848	173,63
3000 PSI	3"1/2 BSP	3"1/2	ZBCRG35656	572,73
3000 PSI	4" BSP	4"	ZBCRG36464	619,16
6000 PSI	1/2" BSP	1/2"	ZBCRG60808	48,47
6000 PSI	3/4" BSP	3/4"	ZBCRG61212	57,22
6000 PSI	1" BSP	1"	ZBCRG61616	70,53
6000 PSI	1"1/4 BSP	1"1/4	ZBCRG62020	87,50
6000 PSI	1"1/2 BSP	1"1/2	ZBCRG62424	110,46
6000 PSI	2" BSP	2"	ZBCRG63232	180,12

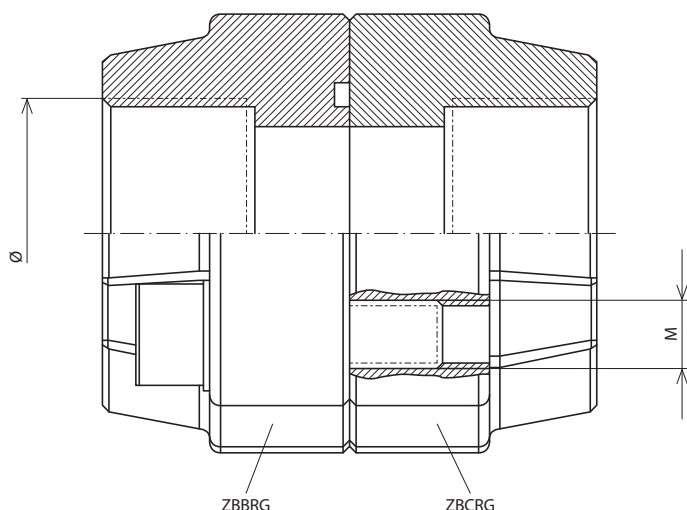

Bridas SAE

SAE Flanges
Brides SAE
Flange SAE

Brida soldable Hembra tubo gas

Welding female flange for gas tube

Bride à souder femelle tube gaz

Flangia femmina a saldare per tubo gas

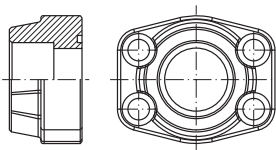

SERIE	Ø INNER Ø INT.	SIZE TAMAÑO	Part nº Referencia	€
3000 PSI	21.6	1/2"	ZBBSG308216	51,68
3000 PSI	27.2	3/4"	ZBBSG312272	57,15
3000 PSI	34.0	1"	ZBBSG316340	64,99
3000 PSI	42.8	1"1/4	ZBBSG320428	74,08
3000 PSI	48.6	1"1/2	ZBBSG324486	101,12
3000 PSI	61.0	2"	ZBBSG332610	119,95
3000 PSI	76.6	2"1/2	ZBBSG340766	150,17
3000 PSI	90.5	3"	ZBBSG348905	156,87
3000 PSI	103.0	3"1/2	ZBBSG3561030	541,77
3000 PSI	115.5	4"	ZBBSG3641155	588,20
6000 PSI	21.6	1/2"	ZBBSG608216	52,78
6000 PSI	27.2	3/4"	ZBBSG612272	61,53
6000 PSI	34.0	1"	ZBBSG616340	74,65
6000 PSI	42.8	1"1/4	ZBBSG620428	94,09
6000 PSI	48.6	1"1/2	ZBBSG624486	114,57
6000 PSI	61.0	2"	ZBBSG632610	180,74

Contrabrida soldable Hembra tubo gas

Welding female counter-flange for gas tube

Contre-bride à souder femelle tube gaz

Controflangia femmina a saldare per tubo gas

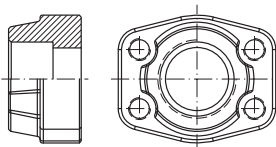

SERIE	Ø INNER Ø INT.	SIZE TAMAÑO	Part nº Referencia	€
3000 PSI	21.6	1/2"	ZBCSG308216	52,41
3000 PSI	27.2	3/4"	ZBCSG312272	57,76
3000 PSI	34.0	1"	ZBCSG316340	65,36
3000 PSI	42.8	1"1/4	ZBCSG320428	73,71
3000 PSI	48.6	1"1/2	ZBCSG324486	100,97
3000 PSI	61.0	2"	ZBCSG332610	119,94
3000 PSI	76.6	2"1/2	ZBCSG340766	150,17
3000 PSI	90.5	3"	ZBCSG348905	184,83
3000 PSI	103.0	3"1/2	ZBCSG3561030	541,77
3000 PSI	115.5	4"	ZBCSG3641155	588,20
6000 PSI	21.6	1/2"	ZBCSG608216	52,78
6000 PSI	27.2	3/4"	ZBCSG612272	61,53
6000 PSI	34.0	1"	ZBCSG616340	74,65
6000 PSI	42.8	1"1/4	ZBCSG620428	91,62
6000 PSI	48.6	1"1/2	ZBCSG624486	114,57
6000 PSI	61.0	2"	ZBCSG632610	184,24

Brida codo 90° soldable Hembra tubo gas

90° welding female flange for gas tube

Bride 90° à souder femelle tube gaz

Flangia a 90° femmina a saldare per tubo gas

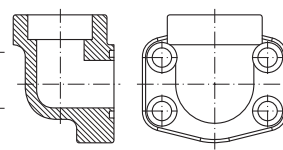

SERIE	Ø INNER Ø INT.	SIZE TAMAÑO	Part nº Referencia	€
3000 PSI	21.6	1/2"	ZB90SG308216	135,62
3000 PSI	27.2	3/4"	ZB90SG312272	130,75
3000 PSI	34.0	1"	ZB90SG316340	156,35
3000 PSI	42.8	1"1/4	ZB90SG320428	188,06
3000 PSI	48.6	1"1/2	ZB90SG324486	259,00
3000 PSI	61.0	2"	ZB90SG332610	340,80
6000 PSI	21.6	1/2"	ZB90SG608216	108,50
6000 PSI	27.2	3/4"	ZB90SG612272	*
6000 PSI	34.0	1"	ZB90SG616340	188,06
6000 PSI	42.8	1"1/4	ZB90SG620428	259,00
6000 PSI	48.6	1"1/2	ZB90SG624486	340,80

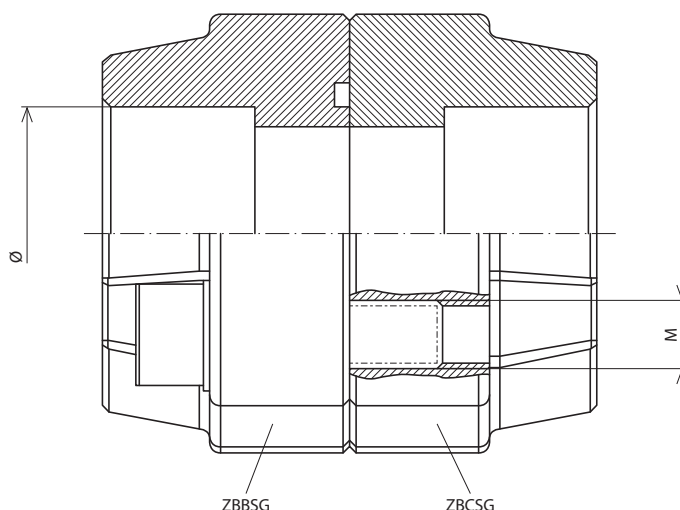

Bridas SAE

SAE Flanges
Brides SAE
Flange SAE

Crimp fittings for hoses

Pipe fittings DIN 2353

Flare fittings JIC 37° / SAE Flanges

Adaptors

Welding fittings

Industrial fittings

Couplings, Ball valves and Hydraulic Components

Brida soldable hembra tubo métrico

Female welding flange for metric tube

Bride à souder femelle tube métrique

Flangia femmina a saldare per tubo Metrico

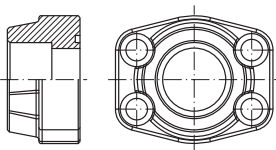

SERIE	Ø INNER Ø INT.	SIZE TAMAÑO	Part n° Referencia	€
3000 PSI	20.3	1/2"	ZBBSM308203	41,08
3000 PSI	25.3	3/4"	ZBBSM312253	60,08
3000 PSI	30.3	1"	ZBBSM316303	75,68
3000 PSI	38.3	1"1/4	ZBBSM320383	94,60
3000 PSI	50.5	1"1/2	ZBBSM324505	114,20
6000 PSI	20.3	1/2"	ZBBSM608203	52,28
6000 PSI	25.3	3/4"	ZBBSM612253	79,00
6000 PSI	30.3	1"	ZBBSM616303	97,92
6000 PSI	38.3	1"1/4	ZBBSM620383	120,68
6000 PSI	50.5	1"1/2	ZBBSM624505	193,92

Brida codo 90° soldable Hembra tubo métrico

90° female welding flange for metric tube

Bride 90° à souder femelle tube métrique

Flangia a 90° femmina a saldare per tubo Metrico

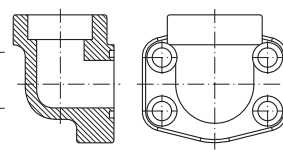

SERIE	Ø INNER Ø INT.	SIZE TAMAÑO	Part n° Referencia	€
3000 PSI	20.3	1/2"	ZB90SM308203	*
3000 PSI	25.3	3/4"	ZB90SM312253	*
3000 PSI	30.3	1"	ZB90SM316303	*
3000 PSI	38.3	1"1/4	ZB90SM320383	*
3000 PSI	50.5	1"1/2	ZB90SM324505	*
6000 PSI	20.3	1/2"	ZB90SM608203	*
6000 PSI	25.3	3/4"	ZB90SM612253	*
6000 PSI	30.3	1"	ZB90SM616303	*
6000 PSI	38.3	1"1/4	ZB90SM620383	*
6000 PSI	50.5	1"1/2	ZB90SM624505	*

Contrabrida soldable hembra tubo métrico

Female welding counter-flange for metric tube

Contre-bride à souder femelle tube métrique

Controflangia femmina a saldare per tubo Metrico

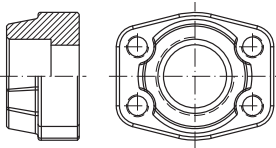

SERIE	Ø INNER Ø INT.	SIZE TAMAÑO	Part n° Referencia	€
3000 PSI	20.3	1/2"	ZBCSM308203	48,96
3000 PSI	25.3	3/4"	ZBCSM312253	60,08
3000 PSI	30.3	1"	ZBCSM316303	75,68
3000 PSI	38.3	1"1/4	ZBCSM320383	94,60
3000 PSI	50.5	1"1/2	ZBCSM324505	114,20
6000 PSI	20.3	1/2"	ZBCSM608203	52,28
6000 PSI	25.3	3/4"	ZBCSM612253	79,00
6000 PSI	30.3	1"	ZBCSM616303	97,92
6000 PSI	38.3	1"1/4	ZBCSM620383	120,68
6000 PSI	50.5	1"1/2	ZBCSM624505	193,92

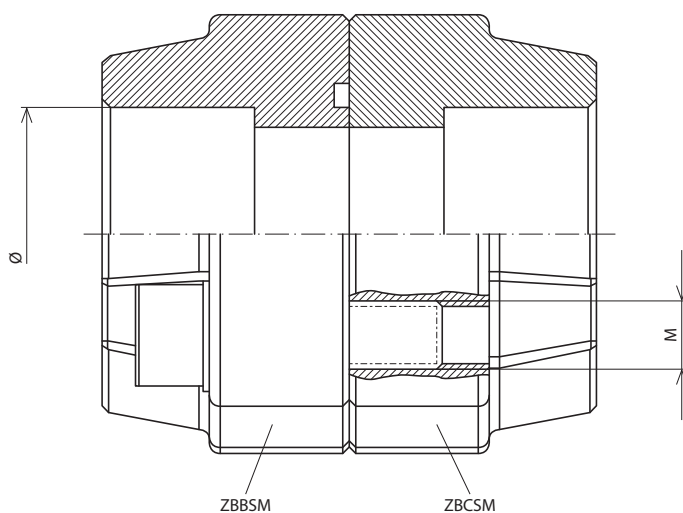

Bridas SAE

SAE Flanges
Brides SAE
Flange SAE

Bridas ciegas

Blind flanges

Brides avec obturateur fermé

Flange cieche

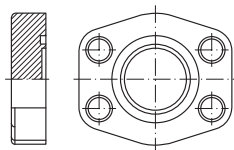

SERIE	SIZE TAMAÑO	Part nº Referencia	€
3000 PSI	1/2"	ZBBC308	64,54
3000 PSI	3/4"	ZBBC312	78,98
3000 PSI	1"	ZBBC316	92,86
3000 PSI	1"1/4	ZBBC320	108,36
3000 PSI	1"1/2	ZBBC324	139,32
3000 PSI	2"	ZBBC332	160,99
3000 PSI	2"1/2	ZBBC340	185,75
3000 PSI	3"	ZBBC348	263,15
3000 PSI	3"1/2	ZBBC356	340,54
3000 PSI	4"	ZBBC364	402,44
6000 PSI	1/2"	ZBBC608	69,11
6000 PSI	3/4"	ZBBC612	92,86
6000 PSI	1"	ZBBC616	117,65
6000 PSI	1"1/4	ZBBC620	167,17
6000 PSI	1"1/2	ZBBC624	263,15
6000 PSI	2"	ZBBC632	386,98

Contrabridas ciegas

Blind counter-flanges

Contre-brides avec obturateur fermé

Controflange cieche

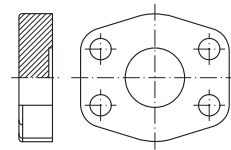

SERIE	SIZE TAMAÑO	Part nº Referencia	€
3000 PSI	1/2"	ZBCC308	72,72
3000 PSI	3/4"	ZBCC312	83,15
3000 PSI	1"	ZBCC316	102,16
3000 PSI	1"1/4	ZBCC320	119,18
3000 PSI	1"1/2	ZBCC324	153,23
3000 PSI	2"	ZBCC332	177,07
3000 PSI	3"	ZBCC348	289,47
3000 PSI	3"1/2	ZBCC356	374,60
3000 PSI	4"	ZBCC364	442,70
6000 PSI	1/2"	ZBCC608	72,75
6000 PSI	3/4"	ZBCC612	102,16
6000 PSI	1"	ZBCC616	129,42
6000 PSI	1"1/4	ZBCC620	183,89
6000 PSI	1"1/2	ZBCC624	289,47
6000 PSI	2"	ZBCC632	425,67

Bridas soldables macho

Male welding flanges
Brides à souder mâle
Flangia a saldare maschio

- **Brida soldable macho tubo gas**
Male welding flange for gas tube
Bride à souder mâle tube gaz
Flangia a saldare maschio tubo gas

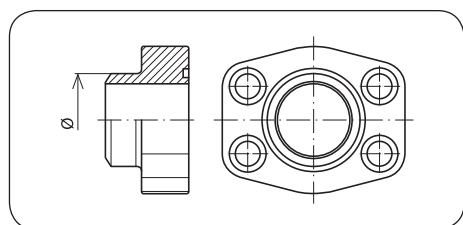

Ref: ZBMSG

- **Contrabrida macho soldable tubo gas**
Male welding counterflange for gas tube
Contre-bride à souder mâle tube gaz
Controflangia a saldare maschio tubo gas

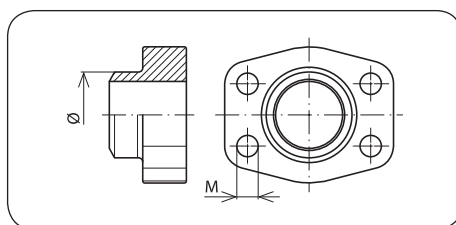

Ref: ZBCMSG

- **Brida soldable macho tubo métrico**
Male welding flange for metric tube
Bride à souder mâle tube métrique
Flangia a saldare maschio tubo metrico

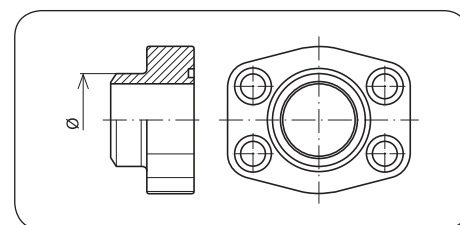

Ref: ZBMSM

- **Contrabrida macho soldable tubo métrico**
Male welding counterflange for metric tube
Contre-bride à souder mâle tube métrique
Controflangia a saldare maschio tubo metrico

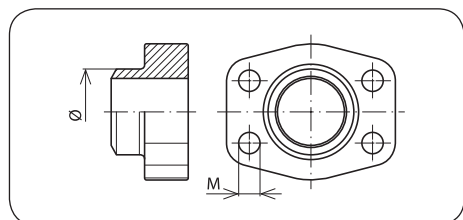

Ref: ZBCMSM

Bridas SAE

SAE Flanges
Brides SAE
Flange SAE

Crimp fittings for hoses

Pipe fittings DIN 2353

Flare fittings JIC 37° / SAE Flanges

Adaptors

Welding fittings

Industrial fittings

Couplings, Ball valves and Hydraulic Components

Brida partida pasante

SAE Split flange

Demi-bride passage total

Semiflangua SAE

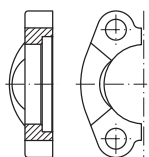

SERIE	Ø INNER Ø INT.	SIZE TAMAÑO	Part nº Referencia	€
3000 PSI	30.2	1/2"	ZBBP308302	*
3000 PSI	38.1	3/4"	ZBBP312381	*
3000 PSI	44.5	1"	ZBBP316445	*
3000 PSI	50.8	1"1/4	ZBBP320508	*
3000 PSI	60.3	1"1/2	ZBBP324603	*
3000 PSI	71.4	2"	ZBBP332714	*
3000 PSI	102.4	3"	ZBBP3481024	*
6000 PSI	31.8	1/2"	ZBBP608318	*
6000 PSI	41.3	3/4"	ZBBP612413	*
6000 PSI	47.6	1"	ZBBP616476	*
6000 PSI	54	1"1/4	ZBBP620540	*
6000 PSI	63.5	1"1/2	ZBBP624635	*
6000 PSI	79.4	2"	ZBBP632794	*

*Ver precios en p. 36 (CONEXIONES) / *See prices in p.36 (FITTINGS) / *Prix à la p.36 (EMBOUTS) / *Vedere prezzi p.36 (RACCORDI)

Contrabrida roscada

SAE counter-flange

Contre-bride passage total

Controflangua SAE

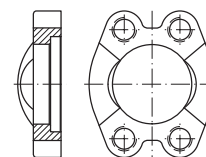

SERIE	Ø	SIZE TAMAÑO	Part nº Referencia	€
3000 PSI	30,2	1/2"	ZBCE308302	*
3000 PSI	38,1	3/4"	ZBCE312381	*
3000 PSI	44,5	1"	ZBCE316445	*
3000 PSI	50,8	1"1/4	ZBCE320508	*
3000 PSI	60,3	1"1/2	ZBCE324603	*
3000 PSI	71,4	2"	ZBCE332714	*
6000 PSI	31,8	1/2"	ZBCE608318	*
6000 PSI	41,3	3/4"	ZBCE612413	*
6000 PSI	47,6	1"	ZBCE616476	*
6000 PSI	54	1"1/4	ZBCE620540	*
6000 PSI	63,5	1"1/2	ZBCE624635	*
6000 PSI	79,4	2"	ZBCE632794	*

*Ver precios en p. 36 (CONEXIONES) / *See prices p.36 (FITTINGS) / *Prix à la p.36 (EMBOUTS) / *Vedere prezzi p.36 (RACCORDI)

Brida entera pasante

SAE Flange

Bride monobloc passage total

Flangia monoblocco SAE

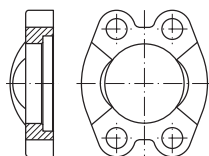

SERIE	Ø INNER Ø INT.	SIZE TAMAÑO	Part nº Referencia	€
3000 PSI	30.2	1/2"	ZBBE308302	*
3000 PSI	38.1	3/4"	ZBBE312381	*
3000 PSI	44.5	1"	ZBBE316445	*
3000 PSI	50.8	1"1/4	ZBBE320508	*
3000 PSI	60.3	1"1/2	ZBBE324603	*
3000 PSI	71.4	2"	ZBBE332714	*
6000 PSI	31.8	1/2"	ZBBE608318	*
6000 PSI	41.3	3/4"	ZBBE612413	*
6000 PSI	47.6	1"	ZBBE616476	*
6000 PSI	54	1"1/4	ZBBE620540	*
6000 PSI	63.5	1"1/2	ZBBE624635	*
6000 PSI	79.4	2"	ZBBE632794	*

*Ver precios en p. 36 (CONEXIONES) / *See prices p.36 (FITTINGS) / *Prix à la p.36 (EMBOUTS) / *Vedere prezzi p.36 (RACCORDI)

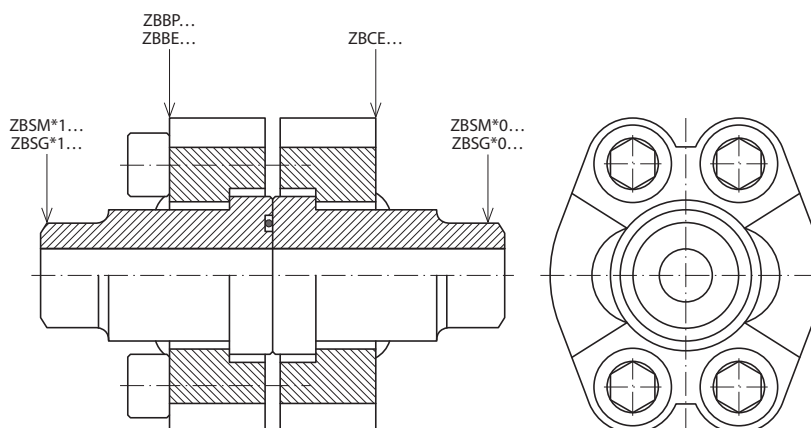

Bridas SAE

SAE Flanges
Brides SAE
Flange SAE

Brida con soldable tubo métrico

Flange welding adaptor for metric tube

Bride collet à souder tube métrique

Adattatore a saldare per tubo Metrico con o'ring

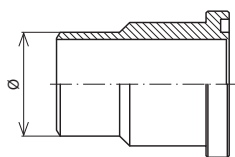

SERIE	Ø INNER Ø INT.	SIZE TAMAÑO	Part n° Referencia	€
3000 PSI	16	1/2"	ZBSM3108016	61,93
3000 PSI	25	3/4"	ZBSM3112025	74,31
3000 PSI	30	1"	ZBSM3116030	92,86
3000 PSI	38	1 1/4"	ZBSM3120038	111,45
3000 PSI	45	1 1/2"	ZBSM3124045	154,79
3000 PSI	60	2"	ZBSM3132060	185,75
3000 PSI	70	2 1/2"	ZBSM3140070	247,65
3000 PSI	80	3"	ZBSM3148080	433,41
3000 PSI	100	3 1/2"	ZBSM3156100	619,16
3000 PSI	114.3	4"	ZBSM3164114	742,99
3000 PSI	139.7	5"	ZBSM3180139	*
6000 PSI	16	1/2"	ZBSM6108016	61,93
6000 PSI	25	3/4"	ZBSM6112025	92,86
6000 PSI	30	1"	ZBSM6116030	102,16
6000 PSI	38	1 1/4"	ZBSM6120038	118,91
6000 PSI	45	1 1/2"	ZBSM6124045	170,26
6000 PSI	60	2"	ZBSM6132060	204,31

Brida con soldable tubo gas

Flange welding adaptor for gas tube

Bride collet à souder tube gaz

Adattatore a saldare per tubo gas con o'ring

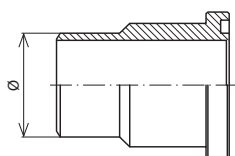

SERIE	Ø INNER Ø INT.	SIZE TAMAÑO	Part n° Referencia	€
3000 PSI	21.5	1/2"	ZBSG3108215	61,93
3000 PSI	28.0	3/4"	ZBSG3112280	74,31
3000 PSI	34.0	1"	ZBSG3116340	92,86
3000 PSI	42.8	1 1/4"	ZBSG3120428	111,45
3000 PSI	48.6	1 1/2"	ZBSG3124486	154,79
3000 PSI	61.0	2"	ZBSG3132610	185,75
6000 PSI	21.5	1/2"	ZBSG6108215	61,93
6000 PSI	28.0	3/4"	ZBSG6112280	92,86
6000 PSI	34.0	1"	ZBSG6116340	102,16
6000 PSI	42.8	1 1/4"	ZBSG6120428	118,91
6000 PSI	48.6	1 1/2"	ZBSG6124486	170,26
6000 PSI	61.0	2"	ZBSG6132610	204,31

Tornillos para bridas SAE

Screws for SAE flanges

Vis pour brides SAE

Vite per flangia SAE



THREAD ROSCA	SIZE TAMAÑO	Part n° Referencia	€
M8X30	3000-6000 PSI 1/2"	ZTB8X30	0,90
M10X35	3000 PSI 3/4"-1"	ZTB10X35	1,70
M10X40	3000 PSI 1" 1/4 - 6000 PSI 3/4"	ZTB10X40	1,86
M12X45	3000 PSI 1" 1/2-2"-2 1/2-6000 PSI 1"	ZTB12X45	2,73
M14X45	6000 PSI 1" 1/4	ZTB14X45	4,71
M16X50	3000 PSI 3"-3 1/2"-4"- 6000 PSI 1" 1/2	ZTB16X50	6,45
M20X70	6000 PSI 2"	ZTB20X70	18,29

Contrabrida con soldable tubo métrico

Counter-flange welding adaptor for metric tube

Contre-bride collet à souder tube métrique

Adattatore a saldare per tubo Metrico sin o'ring

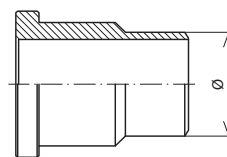

SERIE	Ø INNER Ø INT.	SIZE TAMAÑO	Part n° Referencia	€
3000 PSI	16	1/2"	ZBSM3008016	61,93
3000 PSI	25	3/4"	ZBSM3012025	74,31
3000 PSI	30	1"	ZBSM3016030	92,86
3000 PSI	38	1 1/4"	ZBSM3020038	111,45
3000 PSI	45	1 1/2"	ZBSM3024045	154,79
3000 PSI	60	2"	ZBSM3032060	185,75
3000 PSI	70	2 1/2"	ZBSM3040070	247,65
3000 PSI	80	3"	ZBSM3048080	433,41
3000 PSI	100	3 1/2"	ZBSM3056100	619,16
3000 PSI	114.3	4"	ZBSM3064114	742,99
3000 PSI	139.7	5"	ZBSM3080139	*
6000 PSI	16	1/2"	ZBSM6008016	61,93
6000 PSI	25	3/4"	ZBSM6012025	92,86
6000 PSI	30	1"	ZBSM6016030	102,16
6000 PSI	38	1 1/4"	ZBSM6020038	118,91
6000 PSI	45	1 1/2"	ZBSM6024045	170,26
6000 PSI	60	2"	ZBSM6032060	204,31

Contrabrida con soldable tubo gas

Counter-flange welding adaptor for gas tube

Contre-bride collet à souder tube gaz

Adattatore a saldare per tubo gas sin o'ring

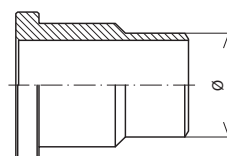

SERIE	Ø INNER Ø INT.	SIZE TAMAÑO	Part n° Referencia	€
3000 PSI	21.5	1/2"	ZBSG3008215	61,93
3000 PSI	28.0	3/4"	ZBSG3012280	74,31
3000 PSI	34.0	1"	ZBSG3016340	92,86
3000 PSI	42.8	1 1/4"	ZBSG3020428	111,45
3000 PSI	48.6	1 1/2"	ZBSG3024486	154,79
3000 PSI	61.0	2"	ZBSG3032610	185,75
6000 PSI	21.5	1/2"	ZBSG6008215	61,93
6000 PSI	28.0	3/4"	ZBSG6012280	92,86
6000 PSI	34.0	1"	ZBSG6016340	102,16
6000 PSI	42.8	1 1/4"	ZBSG6020428	118,91
6000 PSI	48.6	1 1/2"	ZBSG6024486	170,26
6000 PSI	61.0	2"	ZBSG6032610	204,31

Juntas para bridas SAE 3000/6000 PSI

Seals for 3000/6000 PSI flange

Joint pour bride série 3000/6000

Guarnizioni per flangia SAE 3000/6000 PSI



Ø OUTER Ø EXT.	Ø INNER Ø INT.	SIZE TAMAÑO	HEIGHT (MM) ALTURA (MM)	Part n° Referencia	€
25.40	17.02	1/2"	2.79	JBR08	*
31.72	23.36	3/4"	2.79	JBR12	*
39.62	31.24	1"	2.79	JBR16	*
44.45	36.07	1 1/4"	2.79	JBR20	*
53.98	45.34	1 1/2"	2.79	JBR24	*
63.50	54.86	2"	2.79	JBR32	*

LA CALIDAD SIEMPRE ES LO PRIMERO

QUALITY ALWAYS CAMES FIRST

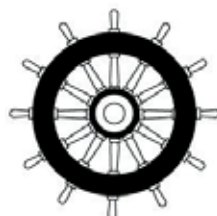

- | | |
|--|---|
| <p>✓ Análisis espectrográfico de materiales - Emisión de certificados de materia prima.</p> | <p>✓ Spectrographic analysis, raw material certificate issue.</p> |
| <p>✓ Validación de los nuevos diseños de Oficina Técnica.</p> | <p>✓ Validation of Technical Department new designs.</p> |
| <p>✓ Gestión de reclamaciones de clientes - ensayos en bancos de prueba, control dimensional.</p> | <p>✓ Management of customers' claims - testing by dimensional control, tests benches.</p> |
| <p>✓ Emisión de certificados de prueba (presión, estanqueidad, dureza, resistencia a la corrosión...).</p> | <p>✓ Test certificate issue (pressure, tightness, hardness, corrosion).</p> |
| <p>✓ Sistema de gestión de calidad total de productos y servicios prestados.</p> | <p>✓ Quality Management System: Products Quality Control across different phases.</p> |
| <p>✓ Emisión de certificados: EN 10204.</p> | <p>✓ Certificates issue: EN 10204.</p> |



Adaptadores

Adaptors

Adapteurs

Adattatori

Adaptadores BSP

BSP Adaptors
Adapteurs BSP
Adattatori BSP

143

Adaptadores NPT

NPT Adaptors
Adapteurs NPT
Adattatori NPT

151

Adaptadores O'Ring Boss

O'Ring Boss Adaptors
Adapteurs O'Ring Boss
Adattatori O'Ring Boss

154

Adaptadores ORFS

ORFS Adaptors
Adapteurs ORFS
Adattatori ORFS

156

4

Adaptadores BSP

BSP Adaptors
Adaptateurs BSP
Adattatori BSP

Crimp fittings for hoses

Pipe fittings DIN 2353

Flare fittings JIC 37° / SAE Flanges

Adaptors

Welding fittings

Industrial fittings

Couplings, Ball valves and Hydraulic Components

■ Uniones rectas macho / Straight adaptors male / Unions mâle / Adattatori diritti maschio

| 143

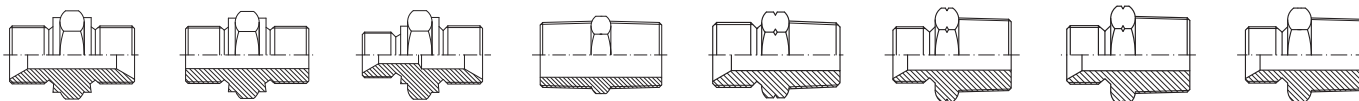

Z1010

Z1011

Z1020

Z1016

Z1014

Z1024

Z1012

Z1022

■ Uniones rectas macho-hembra / Adaptors male-female / Unions mâle-femelle / Adattatori diritti maschio-femmina

| 145

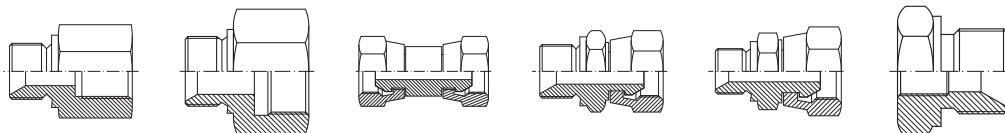

Z1060

Z1060

Z1172

Z1170

Z1173

Z1150

■ Tapones / Plugs / Bouchons / Tappi

| 146

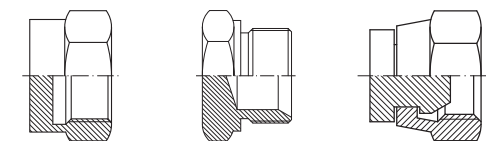

Z1072

Z1070

Z1075

■ Uniones hembra y pasatabiques / Adaptors female and bulkheads / Unions femelle et passe-doison / Raccordi femmina e di attraversamento

| 147

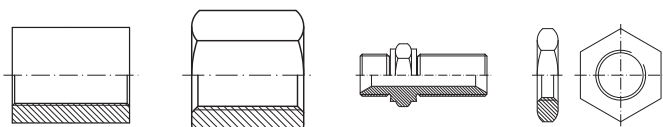

Z1310

Z1031

Z1160

Z1161

■ Orientables / Banjos / Adapteurs orientables / Bulloni forati

| 147

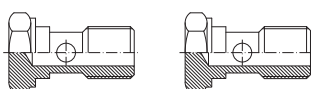

Z1090

Z1092

■ Juntas metal buna y arandelas / Joints / Bague BS / Rondelle e rondelle Bonded

| 148

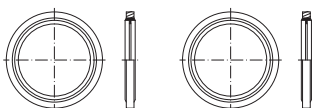

ZVT210

ZVT320

■ Codos accesorios / Elbows / Adapteurs coude accesoriel / Adattatori a 90° e 45° tubolari

| 148

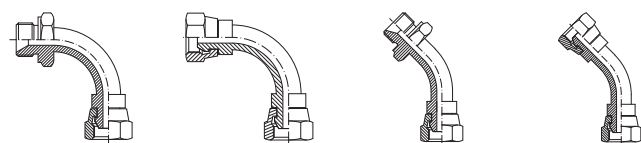

Z1194

ZA1196

Z1195

ZA1195

■ Codos en forja / Forging elbows / Adapteurs coude en forge / Adattatori a 90° forgiati

| 149

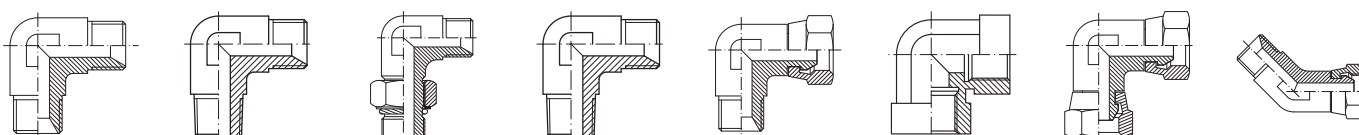

Z1190

Z1192

Z1197

Z1191

Z1193

Z1196

Z1198

Z1183

Adaptadores BSP

BSP Adaptors
Adaptateurs BSP
Adattatori BSP

Crimp fittings for hoses

Pipe fittings DIN 2353

Flare fittings JIC 37° / SAE Flanges

Adaptors

Welding fittings

Industrial fittings

Couplings, Ball valves and Hydraulic Components

■ TES en forja / Forging Tees / Adaptateurs Té en forge / Adattatori a T forgiati

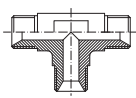

Z1220

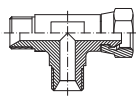

Z1222

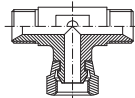

Z1224

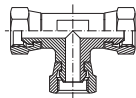

Z1228

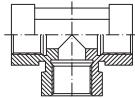

Z1226

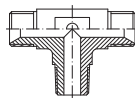

Z1221

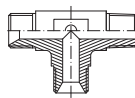

Z1223

Adaptadores NPT

NPT Adaptors
Adaptateurs NPT
Adattatori NPT

■ Uniones rectas macho-macho / Straight adaptors male / Unions mâle / Adattatori diritti maschio - maschio

| 151

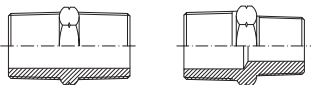

Z1015

ZN1015

■ Uniones rectas macho-hembra / Adaptors male-female / Unions mâle-femelle / Adattatori diritti maschio - femmina

| 151

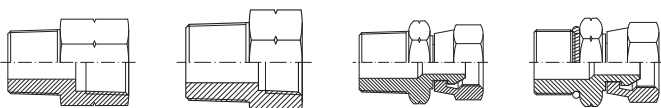

ZN1060

ZN1150

ZN1170

ZN1174

■ Tapones / Plugs / Bouchons / Tappi

| 152

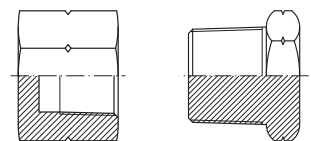

ZN1072

ZN1070

■ Uniones hembra y pasatabiques / Adaptors female and bulkheads / Unions femelle et passe cloisson / Adattatori femmina e passaparete

| 152

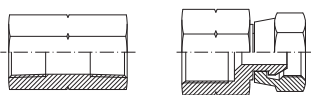

ZN1031

ZN1272

■ Codos en forja / Forging elbows / Adapteurs coude en forge / Adattatori a 90° e 45° forgiati

| 153

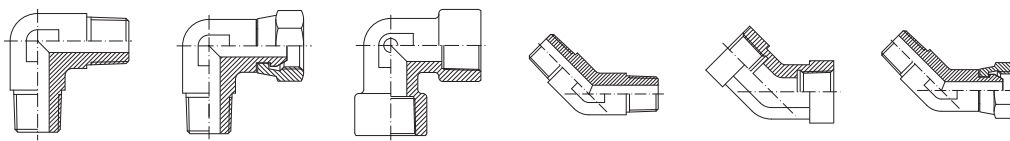

ZN1190

ZN1193

ZN1196

ZN1390

ZN1396

ZN1393

■ Tes en forja / Forging tees / Adapteurs Té en forge / Adattatori a T forgiati

| 153

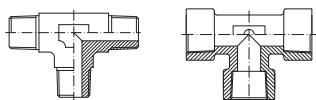

ZN1220

ZN1226

Adaptadores O'Ring Boss

O'Ring Boss Adaptors
 Adapteurs O'Ring Boss
 Adattatori O'Ring Boss

■ Uniones rectas macho / Straight adaptors male / Unions mâle / Unione diritta maschio

| 154

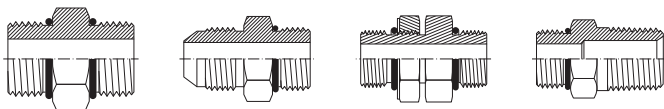

ZS6464

ZS220

ZS3474

ZS6401

■ Uniones rectas macho-hembra / Adaptors male-female / Unions mâle-femelle / Unione diritta maschio-femmina

| 154

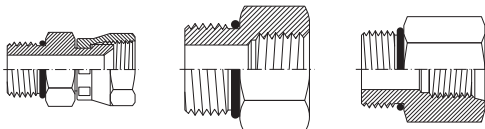

ZS380

ZS6405

ZS6410

■ Tapones / Plugs / Bouchons / Tappi

| 155

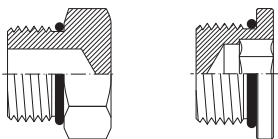

ZS6408

ZS6409

■ Codos y Tes en forja / Forging elbows and tees / Adapteurs coude et té en forge / Curve e T forgiati

| 155

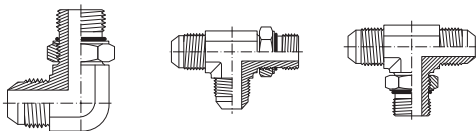

ZS575

ZS6803

ZS6804

Adaptadores ORFS

ORFS Adaptors
Adaptateurs ORFS
Adattatori ORFS

■ Tuercas, conos y tapones ORFS / ORFS Nuts, nipples and plugs / Écrous, collets et bouchons ORFS / Dados, Ogive e Tappi

| 156

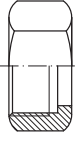

ZOR102

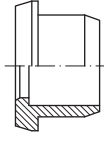

ZOR1273

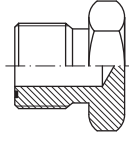

ZOR104

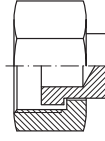

ZOR105

■ Uniones rectas ORFS / ORFS Straight unions / Unions droites ORFS / Adattatori diritti ORFS

| 156

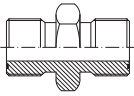

ZOR200

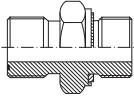

ZOR202

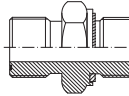

ZOR1017

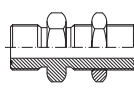

ZOR106

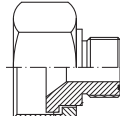

ZOR301

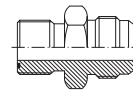

ZOR204

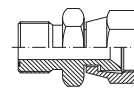

ZOR302

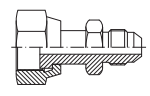

ZOR305

■ Codos ORFS / ORFS Elbows / Coudes ORFS / Adattatori a 90° ORFS

| 158

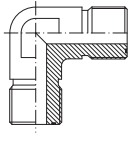

ZOR405

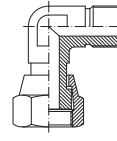

ZOR600

■ Tes ORFS / ORFS Tees / Tés ORFS / Adattatori a T ORFS

| 158

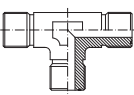

ZOR700

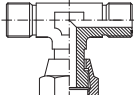

ZOR701

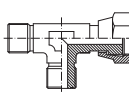

ZOR702



JVORFS

Adaptadores BSP

BSP Adaptors
Adaptateurs BSP
Adattatori BSP

Adaptador macho - macho BSP cono 60°

Adaptor male BSP 60° - male BSP 60°

Adaptateur mâle BSP - mâle BSP cone 60°

Niples di giunzione BSP 60°

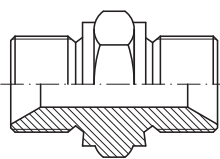

THREAD ROSCA		Part n° Referencia	€
1/8" BSP	1/8" BSP	Z101002	7,90
1/4" BSP	1/4" BSP	Z101004	7,43
1/4" BSP	1/4" BSP	Z101004H19	9,41
3/8" BSP	3/8" BSP	Z101006	8,73
1/2" BSP	1/2" BSP	Z101008	11,45
5/8" BSP	5/8" BSP	Z101010	18,24
3/4" BSP	3/4" BSP	Z101012	17,57
1" BSP	1" BSP	Z101016	30,22
1"1/4 BSP	1"1/4 BSP	Z101020	43,05
1"1/2 BSP	1"1/2 BSP	Z101024	56,05
2" BSP	2" BSP	Z101032	106,84
2" BSP	2" BSP	Z101032H70	139,94

Adaptador macho - macho BSP asiento plano

Adaptor male BSP - male BSP flat seat

Adaptateur mâle BSP - mâle BSP fond plat

Niples di giunzione BSP sede piana

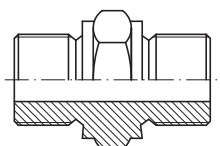

THREAD ROSCA		Part n° Referencia	€
1/4 BSP	1/4 BSP	Z101104	9,73
3/8 BSP	3/8 BSP	Z101106	11,83
1/2 BSP	1/2 BSP	Z101108	14,66
3/4 BSP	3/4 BSP	Z101112	19,98
1" BSP	1" BSP	Z101116	33,31
1"1/4 BSP	1"1/4 BSP	Z101120	49,09
1"1/2 BSP	1"1/2 BSP	Z101124	66,40
2" BSP	2" BSP	Z101132	110,73

Reductor macho - macho BSP cono 60°

Reducer adaptor male BSP 60° - male BSP 60°

Réducteur mâle BSP - mâle BSP cone 60°

Niples di riduzione BSP 60°

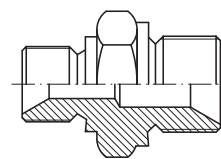

THREAD ROSCA		Part n° Referencia	€
1/8" BSP	1/4" BSP	Z10200204	8,02
1/8" BSP	1/4" BSP	Z10200204H19	9,40
1/8" BSP	3/8" BSP	Z10200206	13,15
1/4" BSP	3/8" BSP	Z10200406	9,45
1/4" BSP	1/2" BSP	Z10200408	14,09
1/4" BSP	3/4" BSP	Z10200412	19,89
3/8" BSP	1/2" BSP	Z10200608	12,97
3/8" BSP	3/4" BSP	Z10200612	19,06
1/2" BSP	3/4" BSP	Z10200812	19,19
1/2" BSP	1" BSP	Z10200816	32,91
5/8" BSP	1/2" BSP	Z10201008	26,26
5/8" BSP	3/4" BSP	Z10201012	37,86
3/4" BSP	1" BSP	Z10201216	33,32
3/4" BSP	1"1/4 BSP	Z10201220	49,21
1" BSP	1"1/4 BSP	Z10201620	48,38
1" BSP	1"1/2 BSP	Z10201624	74,00
1"1/4 BSP	1"1/2 BSP	Z10202024	71,14
1"1/4 BSP	2" BSP	Z10202032	113,07
1"1/2 BSP	2" BSP	Z10202432	111,96
1"1/2 BSP	2" BSP	Z10202432H70	144,88

Adaptador macho - macho BSPT

Adaptor male BSPT - male BSPT

Adaptor mâle gaz conique BSPT - mâle gaz conique BSPT

Niples di congiunzione BSPT

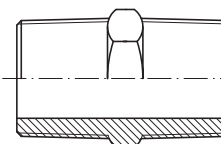

THREAD ROSCA		Part n° Referencia	€
1/4" BSPT	1/4" BSPT	Z10160404	9,24
3/8" BSPT	3/8" BSPT	Z10160606	12,16
1/2" BSPT	1/2" BSPT	Z10160808	12,89
3/4" BSPT	3/4" BSPT	Z10161212	20,55
1" BSPT	1" BSPT	Z10161616	30,08
1" 1/4 BSPT	1" 1/4 BSPT	Z10162020	58,33
1" 1/2 BSPT	1" 1/2 BSPT	Z10162424	80,12
2" BSPT	2" BSPT	Z10163232	124,18

Adaptador macho BSP 60° - macho NPT

Adaptor male BSP 60° - male NPT

Adaptateur mâle BSP cone 60° - mâle BRIGGS (NPT)

Niples di congiunzione BSP 60° - NPT

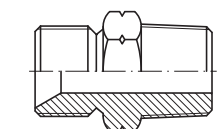

THREAD ROSCA		Part n° Referencia	€
1/8" BSP	1/8" NPT	Z101402	9,27
1/4" BSP	1/4" NPT	Z101404	7,85
3/8" BSP	3/8" NPT	Z101406	9,90
1/2" BSP	1/2" NPT	Z101408	12,76
3/4" BSP	3/4" NPT	Z101412	17,25
1" BSP	1" NPT	Z101416	30,78
1"1/4 BSP	1"1/4 NPT	Z101420	45,73
1"1/2 BSP	1"1/2 NPT	Z101424	72,02
2" BSP	2" NPT	Z101432	101,23

Adaptadores BSP

BSP Adaptors
Adaptateurs BSP
Adattatori BSP

Reductor macho BSP 60° - macho NPT

Reducer adaptor male BSP 60° - male NPT

Réducteur mâle BSP cone 60° - mâle BRIGGS NPT

Niples di riduzione BSP 60° - NPT

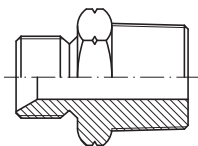

THREAD ROSCA		Part n° Referencia	€
1/8" BSP	1/4" NPT	Z10240204	12,90
1/4" BSP	1/8" NPT	Z10240402	13,30
1/4" BSP	3/8" NPT	Z10240406	11,72
1/4" BSP	1/2" NPT	Z10240408	15,02
3/8" BSP	1/4" NPT	Z10240604	14,60
3/8" BSP	1/2" NPT	Z10240608	15,41
3/8" BSP	3/4" NPT	Z10240612	21,25
1/2" BSP	3/8" NPT	Z10240806	16,10
1/2" BSP	3/4" NPT	Z10240812	22,27
5/8" BSP	3/4" NPT	Z10241012	32,37
3/4" BSP	1/4" NPT	Z10241204	37,44
3/4" BSP	3/8" NPT	Z10241206	24,91
3/4" BSP	1/2" NPT	Z10241208	24,80
3/4" BSP	1" NPT	Z10241216	29,23
3/4" BSP	1" 1/4 NPT	Z10241220	74,09
3/4" BSP	1" 1/2 NPT	Z10241224	81,26
1" BSP	1/2" NPT	Z10241608	35,13
1" BSP	3/4" NPT	Z10241612	34,98
1" BSP	1" 1/4 NPT	Z10241620	59,91
1" 1/4 BSP	1" NPT	Z10242016	68,71
1" 1/4 BSP	1" 1/2 NPT	Z10242024	75,15
1" 1/2 BSP	1" 1/4 NPT	Z10242420	76,57
1" 1/2 BSP	2" NPT	Z10242432	108,99
2" BSP	1" 1/2 NPT	Z10243224	111,20

Adaptador macho BSP 60° - macho BSPT

Adaptor male BSP 60° - male BSPT

Adaptateur mâle BSP cone 60° - mâle gaz conique BSPT

Niples di congiunzione BSP 60° - BSPT

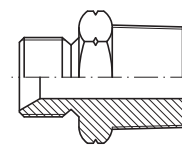

THREAD ROSCA		Part n° Referencia	€
1/8" BSP	1/8" BSPT	Z101202	9,08
1/4" BSP	1/4" BSPT	Z101204	7,88
3/8" BSP	3/8" BSPT	Z101206	9,89
1/2" BSP	1/2" BSPT	Z101208	12,69
3/4" BSP	3/4" BSPT	Z101212	17,28
1" BSP	1" BSPT	Z101216	30,17
1" 1/4 BSP	1" 1/4 BSPT	Z101220	52,58
1" 1/2 BSP	1" 1/2 BSPT	Z101224	70,34
2" BSP	2" BSPT	Z101232	101,44

Reductor macho BSP 60° - macho BSPT

Reducer adaptor male BSP 60° - male BSPT

Réducteur mâle BSP cone 60° - mâle gaz conique BSPT

Niples di riduzione BSP 60° - BSPT

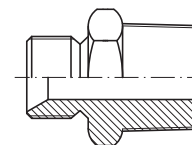

THREAD ROSCA		Part n° Referencia	€
1/8" BSP	1/4" BSPT	Z10220204	12,90
1/4" BSP	1/8" BSPT	Z10220402	10,55
1/4" BSP	3/8" BSPT	Z10220406	12,30
1/4" BSP	1/2" BSPT	Z10220408	14,09
1/4" BSP	3/4" BSPT	Z10220412	29,37
3/8" BSP	1/2" BSPT	Z10220608	13,15
3/8" BSP	3/4" BSPT	Z10220612	28,38
1/2" BSP	1/4" BSPT	Z10220804	21,69
1/2" BSP	3/8" BSPT	Z10220806	16,11
1/2" BSP	3/4" BSPT	Z10220812	22,34
1/2" BSP	1" BSPT	Z10220816	33,31
5/8" BSP	3/4" BSPT	Z10221012	22,67
3/4" BSP	1/4" BSPT	Z10221204	25,14
3/4" BSP	3/8" BSPT	Z10221206	20,74
3/4" BSP	1/2" BSPT	Z10221208	20,44
3/4" BSP	1" BSPT	Z10221216	28,75
1" BSP	3/4" BSPT	Z10221612	31,79
1" BSP	1" 1/4 BSPT	Z10221620	62,41
1" 1/4 BSP	1" BSPT	Z10222016	68,24
1" 1/4 BSP	1" 1/2 BSPT	Z10222024	75,08
1 1/2" BSP	1 1/4" BSPT	Z10222420	76,82
1" 1/2 BSP	2" BSPT	Z10222432	114,93

Adaptadores BSP

BSP Adaptors
Adaptateurs BSP
Adattatori BSP

Prolongador macho BSP 60° - hembra fija BSP

Adaptor male BSP 60° - fixed female BSP

Prolongateur mâle BSP cone 60° - femelle gaz fixe

Prolunga maschio - femmina BSP 60°

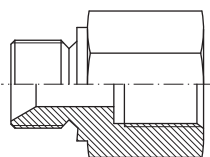

THREAD ROSCA		Part n° Referencia	€
M 1/8" BSP	F 1/8" BSP	Z106002	17,14
M 1/4" BSP	F 1/4" BSP	Z106004	15,83
M 3/8" BSP	F 3/8" BSP	Z106006	13,44
M 1/2" BSP	F 1/2" BSP	Z106008	16,25
M 3/4" BSP	F 3/4" BSP	Z106012	24,09
M 1" BSP	F 1" BSP	Z106016	35,74
M 1"1/4 BSP	F 1"1/4 BSP	Z106020	69,86
M 1"1/2 BSP	F 1"1/2 BSP	Z106024	85,95
M 2" BSP	F 2" BSP	Z106032	132,66

Reductor macho BSP 60° - hembra fija BSP

Reducer adaptor male BSP 60° - fixed female BSP

Prolongateur réducteur mâle BSP cone 60° - femelle gaz

Prolunga di riduzione maschio - femmina BSP 60°

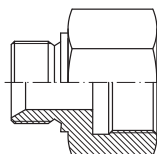

THREAD ROSCA		Part n° Referencia	€
M 1/8" BSP	F 1/4" BSP	Z10600204	15,02
M 1/8" BSP	F 3/8" BSP	Z10600206	23,28
M 1/4" BSP	F 1/8" BSP	Z10600402	16,43
M 1/4" BSP	F 3/8" BSP	Z10600406	21,28
M 1/4" BSP	F 1/2" BSP	Z10600408	23,07
M 3/8" BSP	F 1/4" BSP	Z10600604	17,54
M 3/8" BSP	F 1/2" BSP	Z10600608	20,07
M 1/2" BSP	F 1/4" BSP	Z10600804	24,40
M 1/2" BSP	F 3/8" BSP	Z10600806	18,46
M 1/2" BSP	F 3/4" BSP	Z10600812	23,72
M 3/4" BSP	F 3/8" BSP	Z10601206	21,24
M 3/4" BSP	F 1/2" BSP	Z10601208	21,21
M 3/4" BSP	F 1" BSP	Z10601216	33,55
M 1" BSP	F 3/4" BSP	Z10601612	37,70
M 1" BSP	F 1"1/4 BSP	Z10601620	73,03
M 1"1/4 BSP	F 1" BSP	Z10602016	71,81
M 1"1/2 BSP	F 1"1/4 BSP	Z10602420	84,04
M 1"1/2 BSP	F 2" BSP	Z10602432	113,39
M 2" BSP	F 1"1/2 BSP	Z10603224	111,88

Adaptador hembra giratoria - hembra giratoria BSP 60°

Adaptor BSP 60° swivel female - BSP 60° swivel female

Adaptateur femelle tournante BSP 60° - femelle tournante BSP 60°

Niples femmina - femmina girevole BSP 60°

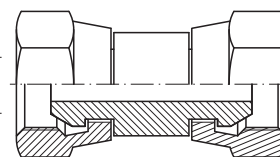

THREAD ROSCA		Part n° Referencia	€
1/4" BSP	1/4" BSP	Z117204	17,27
3/8" BSP	3/8" BSP	Z117206	20,25
1/2" BSP	1/2" BSP	Z117208	21,47
3/4" BSP	3/4" BSP	Z117212	30,96
1" BSP	1" BSP	Z117216	50,91
1" 1/2 BSP	1" 1/2 BSP	Z117224	107,21

Adaptador macho - hembra giratoria BSP cono 60°

Adaptor male BSP 60° - swivel female BSP 60°

Adaptateur mâle BSP - femelle tournante BSP cone 60°

Niples maschio - femmina girevole BSP 60°

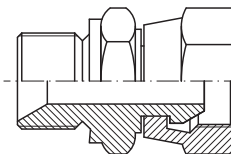

THREAD ROSCA		Part n° Referencia	€
M 1/4" BSP	F 1/4" BSP	Z117004	14,32
M 3/8" BSP	F 3/8" BSP	Z117006	17,48
M 1/2" BSP	F 1/2" BSP	Z117008	22,43
M 3/4" BSP	F 3/4" BSP	Z117012	28,63
M 1" BSP	F 1" BSP	Z117016	52,09
M 1"1/4 BSP	F 1"1/4 BSP	Z117020	86,87
M 1"1/2 BSP	F 1"1/2 BSP	Z117024	107,98
M 2" BSP	F 2" BSP	Z117032	197,68

Reductor macho - hembra giratoria BSP cono 60°

Reducer male BSP 60° - swivel female BSP 60°

Réducteur mâle BSP - femelle tournante BSP cone 60°

Niples di riduzione maschio - femmina girevole BSP 60°

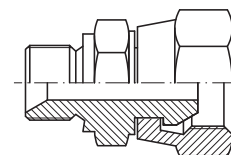

THREAD ROSCA		Part n° Referencia	€
M 1/8" BSP	F 1/4" BSP	Z11730204	14,21
M 1/4" BSP	F 1/8" BSP	Z11730402	16,04
M 1/4" BSP	F 3/8" BSP	Z11730406	19,60
M 3/8" BSP	F 1/4" BSP	Z11730604	20,31
M 3/8" BSP	F 1/2" BSP	Z11730608	22,15
M 1/2" BSP	F 3/8" BSP	Z11730806	26,19
M 1/2" BSP	F 3/4" BSP	Z11730812	33,34
M 3/4" BSP	F 1/2" BSP	Z11731208	34,25
M 3/4" BSP	F 1" BSP	Z11731216	55,35
M 1" BSP	F 3/4" BSP	Z11731612	55,07
M 1" BSP	F 1"1/4 BSP	Z11731620	88,05
M 1" 1/4 BSP	F 1" BSP	Z11732016	103,26
M 1"1/4 BSP	F 1"1/2 BSP	Z11732024	117,01
M 1" 1/2 BSP	F 1" 1/4 BSP	Z11732420	117,04
M 1" 1/2 BSP	F 2" BSP	Z11732432	184,97
M 2" BSP	F 1" 1/2 BSP	Z11733224	167,34

Adaptadores BSP

BSP Adaptors
Adaptateurs BSP
Adattatori BSP

Tapón reductor macho BSP 60° - hembra fija BSP

Reducer plug male BSP 60° - fixed female BSP

Bouchon réducteur mâle BSP cone 60° - femelle gaz

Tappo di riduzione maschio - femmina BSP 60°

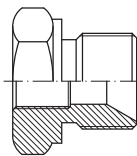

THREAD ROSCA		Part n° Referencia	€
M 1/4" BSP	F 1/8" BSP	Z11500402	8,30
M 3/8" BSP	F 1/8" BSP	Z11500602	11,15
M 3/8" BSP	F 1/4" BSP	Z11500604	9,71
M 1/2" BSP	F 1/4" BSP	Z11500804	15,67
M 1/2" BSP	F 3/8" BSP	Z11500806	13,84
M 3/4" BSP	F 1/2" BSP	Z11501208	17,51
M 1" BSP	F 1/2" BSP	Z11501608	30,36
M 1" BSP	F 3/4" BSP	Z11501612	28,92
M 1 1/4" BSP	F 3/4" BSP	Z11502012	54,61
M 1 1/4" BSP	F 1" BSP	Z11502016	50,15
M 1 1/2" BSP	F 1" BSP	Z11502416	68,60
M 2" BSP	F 1" BSP	Z11503216	108,37
M 2" BSP	F 1 1/4" BSP	Z11503220 *	93,64
M 2" BSP	F 1 1/2" BSP	Z11503224	91,28

*Hasta fin de existencias. / *Until end of stock. / *Jusqu'à la fin du stock. / *Fino ad esaurimento scorta.

Tapón hembra hexagonal rosca BSP

BSP fixed female plug

Bouchon femelle gaz

Tappo femmina fissa BSP

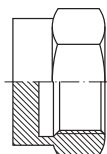

THREAD ROSCA	Part n° Referencia	€
1/4" BSP	Z107204	8,91
3/8" BSP	Z107206	11,09
1/2" BSP	Z107208	12,13
3/4" BSP	Z107212	16,15
1" BSP	Z107216	24,95
1 1/4" BSP	Z107220	34,85
1 1/2" BSP	Z107224	52,66
2" BSP	Z107232	76,80

Tapón macho hexagonal rosca BSP 60°

BSP male hexagonal plug

Bouchon mâle BSP cone 60°

Tappo maschio esagonale BSP

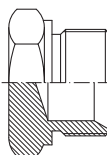

THREAD ROSCA	Part n° Referencia	€
1/8" BSP	Z107002	9,28
1/4" BSP	Z107004	6,20
3/8" BSP	Z107006	7,92
1/2" BSP	Z107008	9,48
3/4" BSP	Z107012	12,43
1" BSP	Z107016	20,21
1 1/4" BSP	Z107020	33,08
1 1/2" BSP	Z107024	47,61
2" BSP	Z107032	64,09

Tapón hembra giratoria BSP cono 60°

BSP swivel female plug

Bouchon femelle tournante BSP cone 60°

Tappo femmina girevole BSP

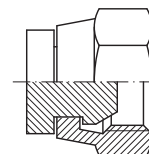

THREAD ROSCA	Part n° Referencia	€
1/4" BSP	Z107504	8,53
3/8" BSP	Z107506	10,23
1/2" BSP	Z107508	11,26
3/4" BSP	Z107512	18,94
1" BSP	Z107516	29,43
1 1/4" BSP	Z107520	47,37
1 1/2" BSP	Z107524	84,90
2" BSP	Z107532	129,24

Adaptadores BSP

BSP Adaptors
Adaptateurs BSP
Adattatori BSP

Manguito redondo roscado hembra BSP

Adaptor female fixed BSP - female fixed BSP

Manchon femelle gaz ronde

Manicoto femmina - femmina BSP

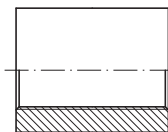

THREAD ROSCA	Part n° Referencia	€
1/8" BSP	Z131002	9,03
1/4" BSP	Z131004	9,56
3/8" BSP	Z131006	14,91
1/2" BSP	Z131008	18,14
1/2" BSP	Z131010	22,02
3/4" BSP	Z131012	23,81
1" BSP	Z131016	33,09
1"1/4 BSP	Z131020	46,99
1"1/2 BSP	Z131024	61,55
2" BSP	Z131032	85,18

Manguito hexagonal roscado hembra BSP

Adaptor hexagonal female fixed BSP - female fixed BSP

Manchon femelle gaz - femelle gaz hexagone

Prolunga esagonale femmina - femmina BSP

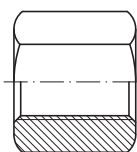

THREAD ROSCA	Part n° Referencia	€
1/4" BSP	Z103104	8,26
3/8" BSP	Z103106	10,34
1/2" BSP	Z103108	15,13
3/4" BSP	Z103112	22,71
1" BSP	Z103116	34,17
1"1/4 BSP	Z103120	62,32
1"1/2 BSP	Z103124	67,07

Tornillo orientable simple BSP

BSP Bolt for banjo

Vis creuse simple pour banjo gaz

Bullone forato BSP

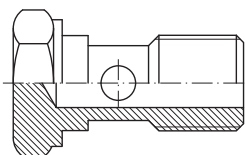

THREAD ROSCA	Part n° Referencia	€
1/4" BSP	Z109004	10,77
3/8" BSP	Z109006	13,72
1/2" BSP	Z109008	15,31
3/4" BSP	Z109012	30,95
1" BSP	Z109016	42,07

Pasatabiques sin tuerca BSP cono 60°

Straight bulkhead adaptor BSP 60° without nut

Passe-cloison mâle BSP 60° - mâle BSP 60° sans équiper

Niples passaparete BSP 60°

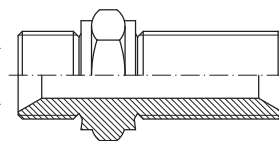

THREAD ROSCA	Part n° Referencia	€
1/4" BSP	Z116004	15,61
3/8" BSP	Z116006	19,15
1/2" BSP	Z116008	23,70
3/4" BSP	Z116012	38,20
1" BSP	Z116016	58,11
1" 1/4 BSP	Z116020	81,19
1" 1/2 BSP	Z116024	113,37
2" BSP	Z116032	209,92

Tuerca pasatabiques BSP

Conter nut for BSP bulkhead

Contre-écrou passe-cloison gaz

Controdado per passaparete

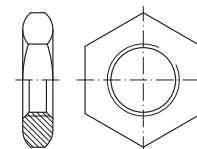

THREAD ROSCA	Part n° Referencia	€
1/4" BSP	Z116104	4,36
3/8" BSP	Z116106	5,95
1/2" BSP	Z116108	6,95
3/4" BSP	Z116112	9,93
1" BSP	Z116116	12,75
1" 1/4 BSP	Z116120	25,75
2" BSP	Z116132	41,83

Tornillo orientable simple Métrico

Metric bolt for banjo

Vis creuse simple for banjo Métrique

Bullone forato Metrico

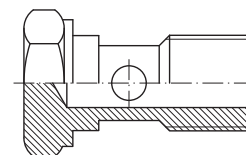

THREAD ROSCA	Part n° Referencia	€
M12X1.5	Z109212	15,29
M14X1.5	Z109214	12,42
M16X1.5	Z109216	12,40
M18X1.5	Z109218	13,27
M22X1.5	Z109222	15,96
M26X1.5	Z109226	36,05
M30X1.5	Z109230	47,11

Adaptadores BSP

BSP Adaptors
Adaptateurs BSP
Adattatori BSP

Juntas metal Buna FKM Gas

BSP Bonded Seal FKM

Bague BS gaz FKM

Rondella Bonded FKM Gas

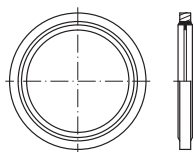

THREAD ROSCA	Part n° Referencia	€
1/8" BSP	ZVT21002	1,19
1/4" BSP	ZVT21004	0,99
3/8" BSP	ZVT21006	1,20
1/2" BSP	ZVT21008	1,96
5/8" BSP	ZVT21010	3,60
3/4" BSP	ZVT21012	2,57
1" BSP	ZVT21016	4,62
1" 1/4 BSP	ZVT21020	7,36
1" 1/2 BSP	ZVT21024	9,01
2"	ZVT21032	11,91

Juntas metal Buna FKM Métricas

Metric Bonded Seal in FKM

Bague BS Métrique FKM

Rondella Bonded FKM Metriche

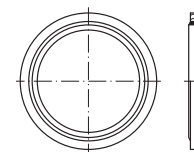

THREAD ROSCA	Part n° Referencia	€
M10X1	ZVT32010	1,44
M12X1,5	ZVT32012	1,33
M14X1,5	ZVT32014	1,73
M16X1,5	ZVT32016	1,87
M18X1,5	ZVT32018	1,98
M20X1,5	ZVT32020	3,02
M22X1,5	ZVT32022	2,56
M24X1,5	ZVT32024	4,90
M26X1,5	ZVT32026	4,93
M30X2	ZVT32030	7,20
M36X2	ZVT32036	8,64
M42X2	ZVT32042	13,32

Codo 90° macho - hembra giratoria BSP cono 60°

90° Elbow swivel female BSP 60° - male BSP 60°

Adapteur coude 90° accessoirel mâle BSP - femelle tournante BSP cone 60°

Curva 90° maschio - femmina girevole BSP 60°

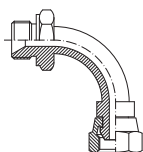

THREAD ROSCA	Part n° Referencia	€	
M 1/4" BSP	F 1/4" BSP	Z119404	26,90
M 3/8" BSP	F 3/8" BSP	Z119406	39,72
M 1/2" BSP	F 1/2" BSP	Z119408	44,35
M 3/4" BSP	F 3/4" BSP	Z119412	56,40
M 1" BSP	F 1" BSP	Z119416	89,92
M 1" 1/4 BSP	F 1" 1/4 BSP	Z119420	153,36
M 1" 1/2 BSP	F 1" 1/2 BSP	Z119424	233,80
M 2" BSP	F 2" BSP	Z119432	347,98

Codo 45° macho - hembra giratoria BSP cono 60°

45° Elbow swivel female BSP 60° - male BSP 60°

Adapteur coude 45° accessoirel mâle BSP - femelle tournante BSP cone 60°

Curva 45° maschio - femmina girevole BSP 60°

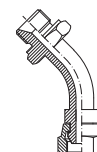

THREAD ROSCA	Part n° Referencia	€	
M 1/4" BSP	F 1/4" BSP	Z119504	40,81
M 3/8" BSP	F 3/8" BSP	Z119506	42,41
M 1/2" BSP	F 1/2" BSP	Z119508	50,19
M 3/4" BSP	F 3/4" BSP	Z119512	66,85
M 1" BSP	F 1" BSP	Z119516	88,99
M 1 1/4" BSP	F 1 1/4" BSP	Z119520	197,23
M 1 1/2" BSP	F 1 1/2" BSP	Z119524	249,89
M 2" BSP	F 2" BSP	Z119532	426,50

Codo 90° hembra giratoria - hembra giratoria BSP cono 60°

90° Elbow swivel female BSP 60° - swivel female BSP 60°

Adapteur coude 90° femelle tournante BSP - femelle tournante cone 60°

Curva 90° femmina - femmina girevole BSP 60°

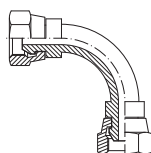

THREAD ROSCA	Part n° Referencia	€	
1/4" BSP	1/4" BSP	ZA119604	31,45
3/8" BSP	3/8" BSP	ZA119606	34,64
1/2" BSP	1/2" BSP	ZA119608	37,20
3/4" BSP	3/4" BSP	ZA119612	52,96
1" BSP	1" BSP	ZA119616	90,30
1" 1/4 BSP	1" 1/4 BSP	ZA119620	163,89

Codo 45° hembra giratoria - hembra giratoria BSP cono 60°

45° Elbow swivel female BSP 60° - swivel female BSP 60°

Adapteur coude 45° femelle tournante BSP - femelle tournante BSP cone 60°

Curva 45° femmina girevole - femmina girevole BSP 60°

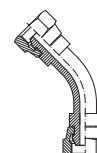

THREAD ROSCA	Part n° Referencia	€	
1/4" BSP	1/4" BSP	ZA119504	43,32
3/8" BSP	3/8" BSP	ZA119506	47,57
1/2" BSP	1/2" BSP	ZA119508	53,52
3/4" BSP	3/4" BSP	ZA119512	71,77
1" BSP	1" BSP	ZA119516	96,39
1" 1/4 BSP	1" 1/4 BSP	ZA119520	235,53

Adaptadores BSP

BSP Adaptors
Adaptateurs BSP
Adattatori BSP

Crimp fittings for hoses

Pipe fittings DIN 2353

Flare fittings JIC 37° / SAE Flanges

Adaptors

Welding fittings

Industrial fittings

Couplings, Ball valves and Hydraulic Components

Codo 90° macho - macho BSP cono 60°

90° Adaptor male - male BSP 60°

Adapteur coude 90° mâle BSP - mâle BSP cono 60° forge

Adattatore a 90° maschio - maschio BSP 60°

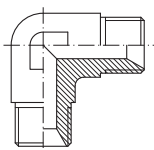

THREAD ROSCA		Part nº Referencia	€
1/8" BSP	1/8" BSP	Z1190002	25,33
1/4" BSP	1/4" BSP	Z1190004	24,21
3/8" BSP	3/8" BSP	Z1190006	29,02
1/2" BSP	1/2" BSP	Z1190008	35,11
3/4" BSP	3/4" BSP	Z1190012	55,99
1" BSP	1" BSP	Z1190016	67,14
1"1/4 BSP	1"1/4 BSP	Z1190020	127,25
1"1/2 BSP	1"1/2 BSP	Z1190024	167,13

Codo 90° macho BSP 60° - macho BSPT

90° Adaptor male BSP 60° - male BSPT

Adapteur coude 90° mâle BSP cono 60° - mâle gaz conique BSPT forge

Adattatore a 90° maschio BSP 60° - maschio BSPT

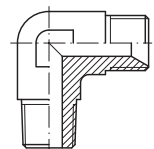

THREAD ROSCA		Part nº Referencia	€
1/8" BSP	1/8" BSPT	Z119202	19,72
1/4" BSP	1/4" BSPT	Z119204	20,03
3/8" BSP	3/8" BSPT	Z119206	29,92
1/2" BSP	1/2" BSPT	Z119208	37,23
3/4" BSP	3/4" BSPT	Z119212	54,57
1" BSP	1" BSPT	Z119216	80,44
1"1/4 BSP	1"1/4 BSPT	Z119220	127,58
1"1/2 BSP	1"1/2 BSPT	Z119224	173,22

Codo 90° regulable macho - macho BSP

90° Adjustable stud elbow male-male BSP

Coude 90° orientable mâle - mâle BSP

Adattatore a 90° orientabile maschio - maschio BSP

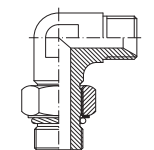

THREAD ROSCA		Part nº Referencia	€
1/4" BSP	1/4" BSP	Z119704	26,33
3/8" BSP	3/8" BSP	Z119706	38,03
1/2" BSP	1/2" BSP	Z119708	58,54
3/4" BSP	3/4" BSP	Z119712	80,61
1" BSP	1" BSP	Z119716	130,46

Codo 90° macho BSP 60° - macho NPT

90° Adaptor male BSP 60° - male NPT

Adapteur coude 90° mâle BSP 60° - mâle NPT forge

Adattatore a 90° maschio BSP 60° - maschio NPT

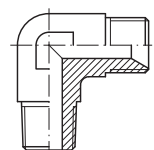

THREAD ROSCA		Part nº Referencia	€
1/4" BSP	1/4" NPT	Z11910404	26,63
3/8" BSP	3/8" NPT	Z11910606	31,92
1/2" BSP	1/2" NPT	Z11910808	38,62
3/4" BSP	3/4" NPT	Z11911212	61,59
1" BSP	1" NPT	Z11911616	73,85

Codo 90° macho - hembra giratoria BSP cono 60°

90° Adaptor male - swivel female BSP 60°

Adapteur coude 90° mâle BSP - femelle tournante BSP cono 60° forge

Adattatore a 90° maschio - femmina girevole BSP 60°

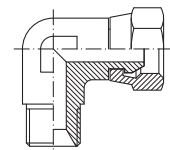

THREAD ROSCA		Part nº Referencia	€
M 1/8" BSP	F 1/8" BSP	Z119302	28,85
M 1/4" BSP	F 1/4" BSP	Z119304	29,26
M 3/8" BSP	F 3/8" BSP	Z119306	33,97
M 1/2" BSP	F 1/2" BSP	Z119308	40,45
M 3/4" BSP	F 3/4" BSP	Z119312	69,34
M 1" BSP	F 1" BSP	Z119316	86,44
M 1"1/4 BSP	F 1"1/4 BSP	Z119320	137,58
M 1"1/2 BSP	F 1"1/2 BSP	Z119324	215,58

Codo 90° hembra fija - hembra fija BSP

90° Adaptor fixed female BSP

Adapteur coude 90° femelle fixe gaz cylindrique forge

Adattatore a 90° femmina fissa BSP

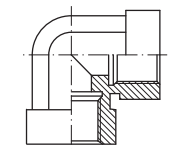

THREAD ROSCA		Part nº Referencia	€
1/8" BSP	1/8" BSP	Z119602	21,53
1/4" BSP	1/4" BSP	Z119604	27,41
3/8" BSP	3/8" BSP	Z119606	31,91
1/2" BSP	1/2" BSP	Z119608	45,91
3/4" BSP	3/4" BSP	Z119612	69,89
1" BSP	1" BSP	Z119616	78,59

Codo 90° hembra giratoria - hembra giratoria BSP cono 60°

90° Adaptor swivel female BSP 60°

Adapteur coude 90° femelle tournante BSP cono 60° forge

Adattatore a 90° femmina girevole BSP 60°

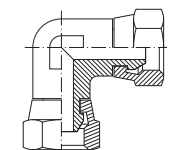

THREAD ROSCA		Part nº Referencia	€
1/4" BSP	1/4" BSP	Z119804	35,18
3/8" BSP	3/8" BSP	Z119806	41,99
1/2" BSP	1/2" BSP	Z119808	52,36
3/4" BSP	3/4" BSP	Z119812	77,83
1" BSP	1" BSP	Z119816	117,58
1"1/4 BSP	1"1/4 BSP	Z119820	210,43
1"1/2 BSP	1"1/2 BSP	Z119824	258,91

Codo 45° macho - hembra giratoria BSP cono 60°

45° Adaptor male - swivel female BSP 60°

Adapteur coude 45° mâle BSP - femelle tournante BSP cono 60° forge

Adattatore a 45° maschio - femmina girevole BSP 60°

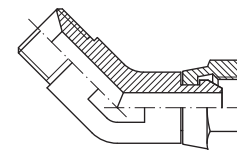

THREAD ROSCA		Part nº Referencia	€
M 1/4" BSP	F 1/4" BSP	Z118304	43,84
M 3/8" BSP	F 3/8" BSP	Z118306	52,31
M 1/2" BSP	F 1/2" BSP	Z118308	61,58
M 3/4" BSP	F 3/4" BSP	Z118312	99,61
M 1" BSP	F 1" BSP	Z118316	133,69

Adaptadores BSP

BSP Adaptors
Adaptateurs BSP
Adattatori BSP

TES macho - macho - macho BSP cono 60°

Tees BSP 60° male

Adaptateurs Té mâle BSP cone 60° forge

Adattatore a T maschio BSP

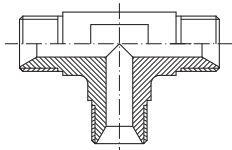

THREAD ROSCA			Part nº Referencia	€
1/4" BSP	1/4" BSP	1/4" BSP	Z122004	30,11
3/8" BSP	3/8" BSP	3/8" BSP	Z122006	40,68
1/2" BSP	1/2" BSP	1/2" BSP	Z122008	41,40
3/4" BSP	3/4" BSP	3/4" BSP	Z122012	69,80
1" BSP	1" BSP	1" BSP	Z122016	103,86
1"1/4 BSP	1"1/4 BSP	1"1/4 BSP	Z122020	139,00
1"1/2 BSP	1"1/2 BSP	1"1/2 BSP	Z122024	231,64

TES macho - macho - hembra giratoria BSP 60°

Tees BSP 60° male - male - swivel female

Adaptateurs Té mâle BSP - mâle BSP - femelle tournante BSP cone 60° forge

Adattatore a T maschio - maschio - femmina girevole BSP

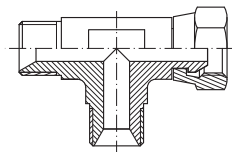

THREAD ROSCA			Part nº Referencia	€
M 1/4" BSP	M 1/4" BSP	F 1/4" BSP	Z122204	37,00
M 3/8" BSP	M 3/8" BSP	F 3/8" BSP	Z122206	49,62
M 1/2" BSP	M 1/2" BSP	F 1/2" BSP	Z122208	57,35
M 3/4" BSP	M 3/4" BSP	F 3/4" BSP	Z122212	86,11
M 1" BSP	M 1" BSP	F 1" BSP	Z122216	126,83
M 1"1/4 BSP	M 1"1/4 BSP	F 1"1/4 BSP	Z122220	167,43
M 1"1/2 BSP	M 1"1/2 BSP	F 1"1/2 BSP	Z122224	283,71

TES macho - hembra giratoria - macho BSP 60°

Tees BSP 60° male - swivel female - male

Adaptateurs Té mâle BSP - femelle tournante - mâle BSP cone 60° forge

Adattatore a T maschio - femmina girevole - maschio BSP

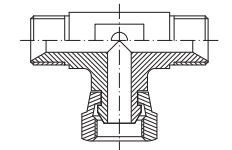

THREAD ROSCA			Part nº Referencia	€
M 1/4" BSP	F 1/4" BSP	M 1/4" BSP	Z122404	37,00
M 3/8" BSP	F 3/8" BSP	M 3/8" BSP	Z122406	49,62
M 1/2" BSP	F 1/2" BSP	M 1/2" BSP	Z122408	57,35
M 3/4" BSP	F 3/4" BSP	M 3/4" BSP	Z122412	86,11
M 1" BSP	F 1" BSP	M 1" BSP	Z122416	126,83
M 1"1/4 BSP	F 1"1/4 BSP	M 1"1/4 BSP	Z122420	167,43
M 1"1/2 BSP	F 1"1/2 BSP	M 1"1/2 BSP	Z122424	283,71

TES hembras giratorias BSP cono 60°

Tees BSP 60° swivel female

Adaptateurs Té femelle tournante BSP cone 60° forge

Adattatore a T femmina - femmina - femmina girevoli BSP

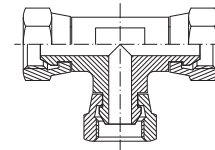

THREAD ROSCA			Part nº Referencia	€
1/4" BSP	1/4" BSP	1/4" BSP	Z122804	49,68
3/8" BSP	3/8" BSP	3/8" BSP	Z122806	60,47
1/2" BSP	1/2" BSP	1/2" BSP	Z122808	72,47
3/4" BSP	3/4" BSP	3/4" BSP	Z122812	114,72
1" BSP	1" BSP	1" BSP	Z122816	148,79
1"1/4 BSP	1"1/4 BSP	1"1/4 BSP	Z122820	257,69
1"1/2 BSP	1"1/2 BSP	1"1/2 BSP	Z122824	341,35

TES hembras fijas BSP

Tees fixed female BSP

Adaptateurs Té femelle gaz forge

Adattatore a T femmina fissa BSP

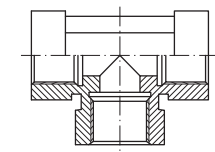

THREAD ROSCA			Part nº Referencia	€
1/4" BSP	1/4" BSP	1/4" BSP	Z122604	30,56
3/8" BSP	3/8" BSP	3/8" BSP	Z122606	51,00
1/2" BSP	1/2" BSP	1/2" BSP	Z122608	65,93
3/4" BSP	3/4" BSP	3/4" BSP	Z122612	86,56
1" BSP	1" BSP	1" BSP	Z122616	131,80

TES macho BSP 60° - macho NPT central - macho BSP 60°

Tees BSP 60° male - NPT male center - BSP 60° male

Adaptateurs Té mâle BSP 60° - mâle NPT central - mâle BSP 60° forge

Adattatore a T maschio - maschio - maschio

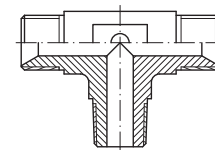

THREAD ROSCA			Part nº Referencia	€
1/4" BSP	1/4" NPT	1/4" BSP	Z12210404	33,12
3/8" BSP	3/8" NPT	3/8" BSP	Z12210606	44,75
1/2" BSP	1/2" NPT	1/2" BSP	Z12210808	45,54
3/4" BSP	3/4" NPT	3/4" BSP	Z12211212	76,78
1" BSP	1" NPT	1" BSP	Z12211616	114,25

TES macho BSP 60° - macho BSP 60° - macho NPT lateral

Tees BSP 60° male - BSP 60° male - NPT male side

Adaptateurs Té mâle BSP 60° - mâle BSP 60° - mâle NPT latéral forge

Adattatore a T maschio - maschio - maschio

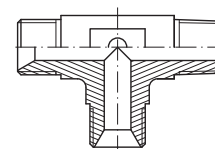

THREAD ROSCA			Part nº Referencia	€
1/4" BSP	1/4" BSP	1/4" NPT	Z12230404	33,12
3/8" BSP	3/8" BSP	3/8" NPT	Z12230606	44,75
1/2" BSP	1/2" BSP	1/2" NPT	Z12230808	45,54
3/4" BSP	3/4" BSP	3/4" NPT	Z12231212	76,78
1" BSP	1" BSP	1" NPT	Z12231616	114,25

Adaptadores NPT

NPT Adaptors
Adaptateurs NPT
Adattatori NPT

Adaptor macho - macho NPT

Adaptor male NPT - male NPT

Adaptateur mâle NPT - mâle NPT

Nipples di congiunzione NPT

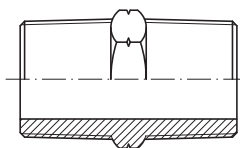

THREAD ROSCA		Part n° Referencia	€
1/4" NPT	1/4" NPT	Z10150404	8,10
3/8" NPT	3/8" NPT	Z10150606	11,19
1/2" NPT	1/2" NPT	Z10150808	11,32
3/4" NPT	3/4" NPT	Z10151212	17,94
1" NPT	1" NPT	Z10151616	34,69
1" 1/4 NPT	1" 1/4 NPT	Z10152020	52,16
1" 1/2 NPT	1" 1/2 NPT	Z10152424	69,36
2" NPT	2" NPT	Z10153232	106,06

Reductor macho - macho NPT

Reducer male NPT - male NPT

Réducteur mâle NPT - mâle NPT

Nipples di riduzione maschio - maschio NPT

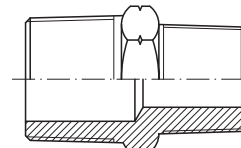

THREAD ROSCA		Part n° Referencia	€
1/4" NPT	1/8" NPT	ZN10150402	12,74
3/8" NPT	1/8" NPT	ZN10150602	15,49
3/8" NPT	1/4" NPT	ZN10150604	14,67
1/2" NPT	1/4" NPT	ZN10150804	20,45
1/2" NPT	3/8" NPT	ZN10150806	18,45
3/4" NPT	1/2" NPT	ZN10151208	20,44
1" NPT	1/2" NPT	ZN10151608	33,87
1" NPT	3/4" NPT	ZN10151612	34,08
1" 1/4 NPT	1" NPT	ZN10152016	68,10
1" 1/2 NPT	1" NPT	ZN10152416	94,56
1" 1/2 NPT	1" 1/4 NPT	ZN10152420	92,91
2" NPT	1" 1/2 NPT	ZN10153224	131,15

Adaptador M - HF NPT

Adaptor male NPT - fixed female NPT

Adaptateur mâle NPT - femelle fixe NPT

Nipples di congiunzione maschio NPT - femmina fissa NPT

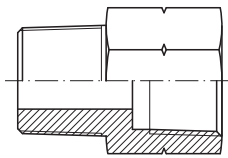

THREAD ROSCA		Part n° Referencia	€
M 1/8" NPT	F 1/8" NPT	ZN10600202	17,04
M 1/8" NPT	F 1/4" NPT	ZN10600204	17,89
M 1/4" NPT	F 1/8" NPT	ZN10600402	16,94
M 1/4" NPT	F 1/4" NPT	ZN10600404	13,92
M 1/4" NPT	F 3/8" NPT	ZN10600406	17,76
M 3/8" NPT	F 1/4" NPT	ZN10600604	17,46
M 3/8" NPT	F 3/8" NPT	ZN10600606	17,35
M 3/8" NPT	F 1/2" NPT	ZN10600608	22,81
M 1/2" NPT	F 3/8" NPT	ZN10600806	20,62
M 1/2" NPT	F 1/2" NPT	ZN10600808	23,16
M 1/2" NPT	F 3/4" NPT	ZN10600812	26,97
M 3/4" NPT	F 1/2" NPT	ZN10601208	29,01
M 3/4" NPT	F 3/4" NPT	ZN10601212	30,28
M 3/4" NPT	F 1" NPT	ZN10601216	39,49
M 1" NPT	F 3/4" NPT	ZN10601612	40,81
M 1" NPT	F 1" NPT	ZN10601616	40,76

Reductor M - HF NPT

Reducer male NPT - fixed female NPT

Réducteur mâle NPT - femelle fixe NPT

Nipples di riduzione maschio NPT - femmina fissa NPT

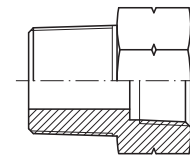

THREAD ROSCA		Part n° Referencia	€
M 3/8" NPT	F 1/8" NPT	ZN11500602	25,51
M 3/8" NPT	F 1/4" NPT	ZN11500604	21,77
M 1/2" NPT	F 1/4" NPT	ZN11500804	30,36
M 1/2" NPT	F 3/8" NPT	ZN11500806	25,04
M 3/4" NPT	F 1/4" NPT	ZN11501204	40,47
M 3/4" NPT	F 3/8" NPT	ZN11501206	52,43
M 3/4" NPT	F 1/2" NPT	ZN11501208	38,74
M 1" NPT	F 3/8" NPT	ZN11501606	64,41
M 1" NPT	F 1/2" NPT	ZN11501608	55,16
M 1" NPT	F 3/4" NPT	ZN11501612	47,27
M 1" 1/4 NPT	F 1" NPT	ZN11502016	86,80
M 1" 1/2 NPT	F 1" NPT	ZN11502416	156,16
M 1" 1/2 NPT	F 1" 1/4 NPT	ZN11502420	122,15

Adaptador M NPT - TL NPSM

Adaptor male NPT - swivel female NPSM

Adaptateur mâle NPT - femelle tournante NPSM

Nipples di congiunzione maschio NPT - femmina girevole NPSM

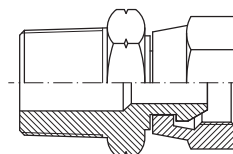

THREAD ROSCA		Part n° Referencia	€
M 1/8" NPT	F 1/8" NPSM	ZN11700202	19,95
M 1/4" NPT	F 1/4" NPSM	ZN11700404	21,03
M 3/8" NPT	F 3/8" NPSM	ZN11700606	24,63
M 3/8" NPT	F 1/2" NPSM	ZN11700608	36,19
M 1/2" NPT	F 1/2" NPSM	ZN11700808	41,31
M 1/2" NPT	F 3/4" NPSM	ZN11700812	52,79
M 3/4" NPT	F 3/4" NPSM	ZN11701212	47,51
M 1" NPT	F 1" NPSM	ZN11701616	56,02
M 1" 1/4 NPT	F 1" 1/4 NPSM	ZN11702020	111,18
M 1" 1/2 NPT	F 1" 1/2 NPSM	ZN11702424	133,41

Adaptadores NPT

NPT Adaptors
Adaptateurs NPT
Adattatori NPT

Adaptador M UNF - TL NPSM

Adaptor male UNF - swivel female NPSM

Adaptateur mâle UNF - femelle tournante NPSM

Nipoli di giunzione maschio UNF - femmina girevole NPSM

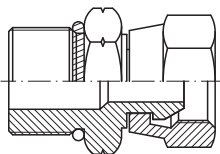

THREAD ROSCA		Part n° Referencia	€
M 7/16" - 20h UNF	F 1/4" - 18h NPSM	ZN11740404	52,14
M 9/16" - 18h UNF	F 3/8" - 18h NPSM	ZN11740606	56,90
M 9/16" - 18h UNF	F 1/2" - 14h NPSM	ZN11740608	76,56
M 3/4" - 16h UNF	F 1/2" - 14h NPSM	ZN11740808	70,77
M 3/4" - 16h UNF	F 3/4" - 14h NPSM	ZN11740812	110,39
M 7/8" - 14h UNF	F 1/2" - 14h NPSM	ZN11741008	84,09
M 7/8" - 14h UNF	F 3/4" - 14h NPSM	ZN11741012	111,92
M 1"1/16 - 12h UNF	F 3/4" - 14h NPSM	ZN11741212	123,22
M 1"5/16 - 12h UNF	F 1" - 11 1/2h NPSM	ZN11741616	150,35
M 1"5/8 - 12h UNF	F 1"1/4 - 11 1/2h NPSM	ZN11742020	241,28

Tapón HF NPT

NPT fixed female plug

Bouchon femelle fixe NPT

Tappo femmina fissa NPT

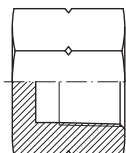

THREAD ROSCA	Part n° Referencia	€
1/8" NPT	ZN107202	12,38
1/4" NPT	ZN107204	14,67
3/8" NPT	ZN107206	17,33
1/2" NPT	ZN107208	20,53
3/4" NPT	ZN107212	23,80
1" NPT	ZN107216	31,75

Tapón macho NPT

NPT male plug

Bouchon mâle NPT

Tappo maschio NPT

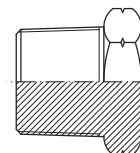

THREAD ROSCA	Part n° Referencia	€
1/8" NPT	ZN107002	5,25
1/4" NPT	ZN107004	8,50
3/8" NPT	ZN107006	11,76
1/2" NPT	ZN107008	12,13
3/4" NPT	ZN107012	12,50
1" NPT	ZN107016	22,60

Adaptador hexagonal HF NPT

NPT hexagonal adaptor fixed female

Adaptateur hexagonal femelle fixe NPT

Adattatore esagonale femmina fissa BSP

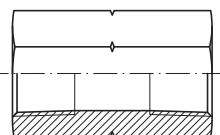

THREAD ROSCA		Part n° Referencia	€
1/8" NPT	1/8" NPT	ZN10310202	7,33
1/4" NPT	1/4" NPT	ZN10310404	11,61
3/8" NPT	3/8" NPT	ZN10310606	14,63
1/2" NPT	1/2" NPT	ZN10310808	19,29
3/4" NPT	3/4" NPT	ZN10311212	23,60
1" NPT	1" NPT	ZN10311616	34,61
1" 1/4 NPT	1" 1/4 NPT	ZN10312020	81,25

Adaptadores NPT

NPT Adaptors
Adaptateurs NPT
Adattatori NPT

Crimp fittings for hoses

Pipe fittings DIN 2353

Flare fittings JIC 37° / SAE Flanges

Adaptors

Welding fittings

Industrial fittings

Couplings, Ball valves and Hydraulic Components

Codo 90° M-M NPT

90° elbow male NPT - male NPT

Coude 90° mâle NPT - mâle NPT

Adattatore a 90° maschio - maschio NPT

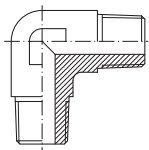

THREAD ROSCA		Part n° Referencia	€
1/8" NPT	1/8" NPT	ZN119002	17,40
1/4" NPT	1/4" NPT	ZN119004	20,19
3/8" NPT	3/8" NPT	ZN119006	27,79
1/2" NPT	1/2" NPT	ZN119008	35,33
3/4" NPT	3/4" NPT	ZN119012	50,07
1" NPT	1" NPT	ZN119016	76,61

Codo 90° M NPT - TL NPSM

90° elbow male NPT - swivel female NPSM

Coude 90° mâle NPT - femelle tournante NPSM

Adattatore a 90° maschio NPT - femmina girevole NPSM

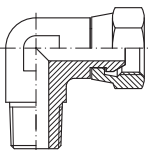

THREAD ROSCA		Part n° Referencia	€
M 1/8" NPT	F 1/8" 27h NPSM	ZN11930202	30,23
M 1/4" NPT	F 1/4" - 18h NPSM	ZN11930404	30,65
M 1/4" NPT	F 3/8" - 18h NPSM	ZN11930406	95,93
M 3/8" NPT	F 3/8" - 18h NPSM	ZN11930606	49,81
M 3/8" NPT	F 1/2" - 14h NPSM	ZN11930608	101,72
M 1/2" NPT	F 1/2" - 14 NPSM	ZN11930808	54,01
M 1/2" NPT	F 3/4" - 14h NPSM	ZN11930812	139,16
M 3/4" NPT	F 1/2" - 14 NPSM	ZN11931208	134,47
M 3/4" NPT	F 3/4" - 14h NPSM	ZN11931212	65,50
M 3/4" NPT	F 1" - 11 1/2 h NPSM	ZN11931216	332,35
M 1" NPT	F 1" - 11 1/2 h NPSM	ZN11931616	98,42
M 1 1/4" NPT	F 1 1/4" - 11 1/2 h NPSM	ZN11932020	125,33

TES M-M-M NPT

NPT male tee

Té mâle NPT

Adattatore a T maschio-maschio-maschio NPT

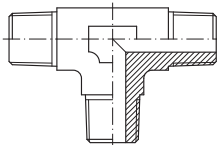

THREAD ROSCA			Part n° Referencia	€
1/8" NPT	1/8" NPT	1/8" NPT	ZN122002	24,99
1/4" NPT	1/4" NPT	1/4" NPT	ZN122004	33,69
3/8" NPT	3/8" NPT	3/8" NPT	ZN122006	39,73
1/2" NPT	1/2" NPT	1/2" NPT	ZN122008	51,70
3/4" NPT	3/4" NPT	3/4" NPT	ZN122012	72,30
1" NPT	1" NPT	1" NPT	ZN122016	98,52

Codo 90° HF-HF NPT

90° elbow fixed female NPT - fixed female NPT

Coude 90° femelle fixe NPT - femelle fixe NPT

Adattatore a 90° femmina fissa - femmina fissa NPT

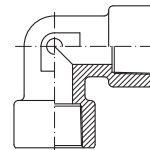

THREAD ROSCA		Part n° Referencia	€
1/8" NPT	1/8" NPT	ZN11960202	18,53
1/4" NPT	1/4" NPT	ZN11960404	27,53
3/8" NPT	3/8" NPT	ZN11960606	30,62
1/2" NPT	1/2" NPT	ZN11960808	44,62
3/4" NPT	3/4" NPT	ZN11961212	67,72
1" NPT	1" NPT	ZN11961616	101,77

Codo 45° M NPT - TL NPSM

45° elbow male NPT - swivel female NPS

Coude 45° mâle NPT - swivel female NPSM

Adattatore a 45° maschio NPT - femmina girevole NPSM

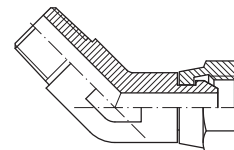

THREAD ROSCA		Part n° Referencia	€
M 1/4" NPT	F 1/4" - 18h NPSM	ZN139304	92,02
M 3/8" NPT	F 3/8" - 18h NPSM	ZN139306	96,38
M 1/2" NPT	F 1/2" - 14h NPSM	ZN139308	118,96
M 3/4" NPT	F 3/4" - 14h NPSM	ZN139312	156,64
M 1" NPT	F 1" - 11 1/2 h NPSM	ZN139316	248,61

TES HF-HF-HF NPT

NPT fixed female tee

Té femelle fixe NPT

Adattatore a T femmina fissa-femmina fissa-femmina fissa NPT

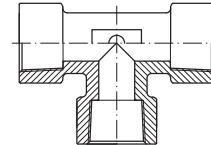

THREAD ROSCA			Part n° Referencia	€
1/8" NPT	1/8" NPT	1/8" NPT	ZN122602	26,72
1/4" NPT	1/4" NPT	1/4" NPT	ZN122604	37,04
3/8" NPT	3/8" NPT	3/8" NPT	ZN122606	50,24
1/2" NPT	1/2" NPT	1/2" NPT	ZN122608	58,56
3/4" NPT	3/4" NPT	3/4" NPT	ZN122612	93,59
1" NPT	1" NPT	1" NPT	ZN122616	137,36

Adaptadores O'Ring Boss

O'Ring Boss Adaptors
Adaptateurs O'Ring Boss
Adattatori O'Ring Boss

Adaptador macho - macho O'Ring Boss

Adaptor male - male O'Ring Boss

Adaptateur mâle - mâle O'Ring Boss

Adattatore maschio-maschio o-ring Boss

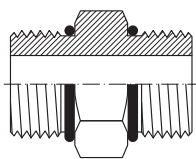

PIPE TUBO		THREAD ROSCA		Part nº Referencia	€
6	1/4	7/16"-20h UNF	7/16"-20h UNF	ZS64640606	10,51
8	5/16	1/2"-20h UNF	1/2"-20h UNF	ZS64640808	10,14
10	3/8	9/16"-18h UNF	9/16"-18h UNF	ZS64641010	10,59
12	1/2	3/4"-16h UNF	3/4"-16h UNF	ZS64641212	13,64
14-15-16	5/8	7/8"-14h UNF	7/8"-14h UNF	ZS64641616	18,62
18-20	3/4	1"1/16-12h UN	1"1/16-12h UN	ZS64642020	26,35
25	1	1"5/16-12h UN	1"5/16-12h UN	ZS64642525	31,67

Adaptador macho O'Ring Boss - macho JIC 37°

Adaptor male O'Ring Boss - male JIC 37°

Adaptateur mâle O'Ring Boss - mâle JIC 37°

Adattatore maschio o-ring Boss - maschio JIC 37°

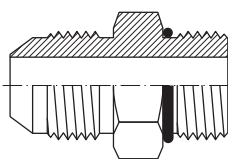

PIPE TUBO		THREAD ROSCA		Part nº Referencia	€
6	1/4	7/16"-20h UNF	7/16"-20h UNF	ZS22006	11,84
8	5/16	1/2"-20h UNF	1/2"-20h UNF	ZS22008	12,58
10	3/8	9/16"-18h UNF	9/16"-18h UNF	ZS22010	13,43
12	1/2	3/4"-16h UNF	3/4"-16h UNF	ZS22012	20,54
14-15-16	5/8	7/8"-14h UNF	7/8"-14h UNF	ZS22016	22,74
18-20	3/4	1"1/16-12h UN	1"1/16-12h UN	ZS22020	30,90
25	1	1"5/16-12h UN	1"5/16-12h UN	ZS22025	50,47
30-32	1 1/4	1"5/8-12h UN	1"5/8-12h UN	ZS22032	86,72
38	1 1/2	1"7/8-12h UN	1"7/8-12h UN	ZS22038	105,14

Adaptador macho O'Ring Boss - hembra giratoria JIC 37°

Adaptor male O'Ring Boss - swivel female JIC 37°

Adaptateur mâle O'Ring Boss - femelle tournante JIC 37°

Adattatore maschio o-ring Boss - femmina gir. JIC 37°

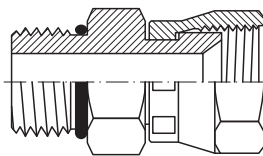

PIPE TUBO		THREAD ROSCA		Part nº Referencia	€
6	1/4	F 7/16" 20h UNF	M 7/16" 20h UNF	ZS38006	16,62
10	3/8	F 9/16" 18h UNF	M 9/16" 18h UNF	ZS38010	18,59
12	1/2	F 3/4" 16h UNF	M 3/4" 16h UNF	ZS38012	27,90
14-15-16	5/8	F 7/8" 14h UNF	M 7/8" 14h UNF	ZS38016	31,61
18-20	3/4	F 1"1/16 12h UN	M 1"1/16 12h UN	ZS38020	42,77
25	1	F 1"5/16 12h UN	M 1"5/16 12h UN	ZS38025	61,01

Adaptador macho O'Ring Boss - macho regulable O'Ring Boss

Adaptor male O'Ring Boss - adjustable male O'Ring Boss

Adaptateur mâle O'Ring Boss - mâle réglable O'Ring Boss

Adattatore maschio o-ring Boss - maschio regolabile o-ring Boss

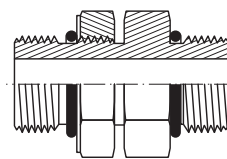

PIPE TUBO		THREAD ROSCA		Part nº Referencia	€
6	1/4	7/16"-20h UNF	7/16"-20h UNF	ZS34740606	*
10	3/8	9/16"-18h UNF	9/16"-18h UNF	ZS34741010	*
12	1/2	3/4"-16h UNF	3/4"-16h UNF	ZS34741212	*
14-15-16	5/8	7/8"-14h UNF	7/8"-14h UNF	ZS34741616	*
18-20	3/4	1"1/16-12h UN	1"1/16-12h UN	ZS34742020	*
25	1	1"5/16-12h UN	1"5/16-12h UN	ZS34742525	*

Adaptador macho O'Ring Boss - macho NPT

Adaptor male O'Ring Boss - male NPT

Adaptateur mâle O'Ring Boss - mâle NPT

Adattatore maschio o-ring Boss - maschio NPT

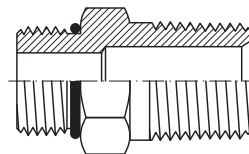

PIPE TUBO		THREAD ROSCA		Part nº Referencia	€
6	1/4	7/16"-20h UNF	1/4" NPT	ZS64010613	10,40
10	3/8	9/16"-18h UNF	3/8" NPT	ZS64011017	10,84
12	1/2	3/4"-16h UNF	1/2" NPT	ZS64011221	15,38
14-15-16	5/8	7/8"-14h UNF	1/2" NPT	ZS64011621	23,10
18-20	3/4	1"1/16-12h UN	3/4" NPT	ZS64012026	30,35
25	1	1"5/16-12h UN	1" NPT	ZS64012533	38,72

Prolongador macho O'Ring Boss - hembra fija NPT

Adaptor male O'Ring Boss - fixed female NPT

Prolongateur mâle O'Ring Boss - femelle fixe NPT

Prolunga machio o-ring Boss - femmina fissa NPT

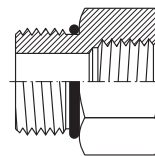

PIPE TUBO		THREAD ROSCA		Part nº Referencia	€
6	1/4	7/16"-20h UNF	1/4" NPT	ZS64050613	19,95
10	3/8	9/16"-18h UNF	3/8" NPT	ZS64051017	22,31
12	1/2	3/4"-16h UNF	1/2" NPT	ZS64051221	33,48
14-15-16	5/8	7/8"-14h UNF	1/2" NPT	ZS64051621	37,93
18-20	3/4	1"1/16-12h UN	3/4" NPT	ZS64052026	51,32
25	1	1"5/16-12h UN	1" NPT	ZS64052533	73,21

Adaptadores O'Ring Boss

O'Ring Boss Adaptors
Adaptateurs O'Ring Boss
Adattatori O'Ring Boss

Crimp fittings for hoses

Pipe fittings DIN 2353

Flare fittings JIC 37° / SAE Flanges

Adaptors

Welding fittings

Industrial fittings

Couplings, Ball valves and Hydraulic Components

Tapón macho O'Ring Boss hexagonal

Male hexagonal O'Ring Boss plug

Bouchon mâle O'Ring Boss hexagonal

Tappo maschio o-ring Boss testa esagonale

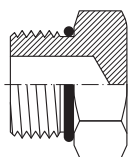

PIPE TUBO		THREAD ROSCA	Part nº Referencia	€
6	1/4	7/16" - 20h UNF	ZS640806	8,35
8	5/16	1/2" - 20h UNF	ZS640808	8,43
10	3/8	9/16" - 18h UNF	ZS640810	10,23
12	1/2	3/4" - 16h UNF	ZS640812	11,39
14-15-16	5/8	7/8" - 14h UNF	ZS640816	15,25
18-20	3/4	1"1/16 - 12h UN	ZS640820	22,57
25	1	1"5/16 - 12h UN	ZS640825	30,52

Tapón macho O'Ring Boss Allen

Male allen O'Ring Boss plug

Bouchon mâle O'Ring Boss allen

Tappo maschio o-ring Boss esagono incassato



PIPE TUBO		THREAD ROSCA	Part nº Referencia	€
6	1/4	7/16" - 20h UNF	ZS640906	9,01
8	5/16	1/2" - 20h UNF	ZS640908	9,10
10	3/8	9/16" - 18h UNF	ZS640910	11,05
12	1/2	3/4" - 16h UNF	ZS640912	12,30
14-15-16	5/8	7/8" - 14h UNF	ZS640916	16,47
18-20	3/4	1"1/16 - 12h UN	ZS640920	24,37
25	1	1"5/16 - 12h UN	ZS640925	32,96

Codo 90° regulable macho O'Ring Boss - macho JIC 37°

90° Adjustable elbow male O'Ring Boss - male JIC 37°

Coude 90° orientable mâle O'Ring Boss - mâle JIC 37°

Curva a 90° regolabile maschio o-ring Boss - maschio JIC 37°

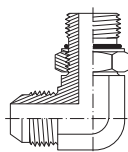

PIPE TUBO		THREAD ROSCA	Part nº Referencia	€
6	1/4	7/16 - 20h UNF	ZS57506	21,66
8	5/16	1/2 - 20h UNF	ZS57508	23,97
10	3/8	9/16 - 18h UNF	ZS57510	27,29
12	1/2	3/4 - 16h UNF	ZS57512	43,77
14-15-16	5/8	7/8 - 14h UNF	ZS57516	56,67
18-20	3/4	1 1/16 - 12h UN	ZS57520	83,30
25	1	1 5/16 - 12h UN	ZS57525	127,08

TE regulable macho JIC 37° - macho O'Ring Boss - macho JIC 37°

Adjustable Tee male JIC 37° - male O'Ring Boss - male JIC 37°

Té orientable macho JIC 37° - macho O'Ring Boss - macho JIC 37°

Tee regolabile maschio JIC 37° - maschio o-ring Boss - maschio JIC 37°

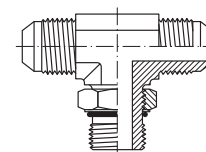

PIPE TUBO		THREAD ROSCA	Part nº Referencia	€
6	1/4	7/16" - 20h UNF	ZS680406	*
8	5/16	1/2"-20h UNF	ZS680408	*
10	3/8	9/16" - 18h UNF	ZS680410	*
12	1/2	3/4" - 16h UNF	ZS680412	*
14-15-16	5/8	7/8" 14h UNF	ZS680416	*
18-20	3/4	1"1/16-12h UN	ZS680420	*
25	1	1" 5/16-12h UN	ZS680425	*

TE regulable macho O'Ring Boss - macho JIC 37° - macho JIC 37°

Adjustable Tee male O'Ring Boss - male JIC 37° - male JIC 37°

Té orientable macho O'Ring Boss - macho JIC 37° - macho JIC 37°

Tee regolabile maschio o-ring Boss - maschio JIC 37° - maschio JIC 37°

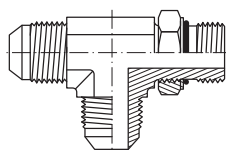

PIPE TUBO		THREAD ROSCA	Part nº Referencia	€
6	1/4	7/16" - 20h UNF	ZS680306	*
8	5/16	1/2" - 20h UNF	ZS680308	*
10	3/8	9/16" - 18h UNF	ZS680310	*
12	1/2	3/4" - 16h UNF	ZS680312	*
14-15-16	5/8	7/8" 14h UNF	ZS680316	*
18-20	3/4	1"1/16-12h UN	ZS680320	*
25	1	1" 5/16-12h UN	ZS680325	*

Adaptadores ORFS

ORFS Adaptors
Adaptateurs ORFS
Adattatori ORFS

Tuerca ORFS

ORFS Nut

Écrou ORFS

Dado ORFS

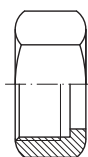

PIPE TUBO	THREAD ROSCA	Part nº Referencia	€
6-8	ORFS 9/16"-18h	ZOR1020400	11,18
10	ORFS 11/16"-18h	ZOR1020600	9,03
12	ORFS 13/16"-16h	ZOR1020800	12,08
14-15-16	ORFS 1"-14h	ZOR1021000	13,76
18-20	ORFS 1"3/16-12h	ZOR1021200	15,10
22-25	ORFS 1"7/16-12h	ZOR1021600	18,09
28-30-32	ORFS 1"11/16-12h	ZOR1022000	44,67
35-38	ORFS 2"-12h	ZOR1022400	52,69

Cono soldar ORFS

ORFS Welding nipple

Collet à souder ORFS

Ogiva a saldare ORFS

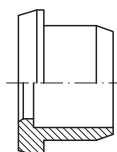

PIPE TUBO	THREAD ROSCA	Part nº Referencia	€
6	ORFS 9/16"-18h	ZOR12730406	8,49
8	ORFS 9/16"-18h	ZOR12730408	8,37
10	ORFS 11/16"-16h	ZOR12730610	9,45
12	ORFS 13/16"-16h	ZOR12730812	10,10
14	ORFS 1"-14h	ZOR12731014	12,60
15	ORFS 1"-14h	ZOR12731015	12,66
16	ORFS 1"-14h	ZOR12731016	12,73
18	ORFS 1" 3/16-12h	ZOR12731218	22,15
20	ORFS 1" 3/16-12h	ZOR12731220	22,15
22	ORFS 1" 7/16-12h	ZOR12731622	30,16
30	ORFS 1"11/16-12h	ZOR12732030	39,67
32	ORFS 1"11/16-12h	ZOR12732032	39,67
38	ORFS 2"-12h	ZOR12732438	72,08

Adaptador macho-macho ORFS

ORFS Male adaptor

Adaptateur mâle ORFS

Adattatore maschio ORFS

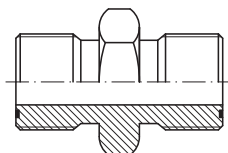

THREAD ROSCA	Part nº Referencia	€	
ORFS 9/16"-18h	ORFS 9/16"-18h	ZOR2000404	20,44
ORFS 11/16"-16h	ORFS 11/16"-16h	ZOR2000606	20,17
ORFS 13/16"-12h	ORFS 13/16"-12h	ZOR2000808	21,29
ORFS 1"-14h	ORFS 1"-14h	ZOR2001010	27,06
ORFS 1"3/16-12h	ORFS 1"3/16-12h	ZOR2001212	31,28
ORFS 1"7/16-12h	ORFS 1"7/16-12h	ZOR2001616	42,56
ORFS 1"11/16-12h	ORFS 1"11/16-12h	ZOR2002020	65,46
ORFS 2"-12h	ORFS 2"-12h	ZOR2002424	92,85

Tapón macho ORFS

ORFS Male plug

Bouchon mâle ORFS

Tappo maschio ORFS

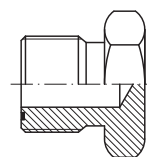

THREAD ROSCA	Part nº Referencia	€
ORFS 9/16"-18h	ZOR1040400	8,63
ORFS 11/16"-16h	ZOR1040600	11,17
ORFS 13/16"-16h	ZOR1040800	11,63
ORFS 1"-14h	ZOR1041000	18,84
ORFS 1"3/16-12h	ZOR1041200	25,49
ORFS 1"7/16-12h	ZOR1041600	42,22
ORFS 1"11/16-12h	ZOR1042000	53,98
ORFS 2"-12h	ZOR1042400	67,22

Tapón hembra ORFS

ORFS Female plug

Bouchon femelle ORFS

Tappo femmina ORFS

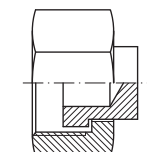

THREAD ROSCA	Part nº Referencia	€
ORFS 9/16"-18h	ZOR1050400	16,46
ORFS 11/16"-16h	ZOR1050600	17,39
ORFS 13/16"-16h	ZOR1050800	18,00
ORFS 1"-14h	ZOR1051000	23,41
ORFS 1"3/16-12h	ZOR1051200	41,40
ORFS 1"7/16-12h	ZOR1051600	50,55
ORFS 1"11/16-12h	ZOR1052000	66,27
ORFS 2"-12h	ZOR1052400	87,89

Adaptador macho ORFS-macho BSP

ORFS Male - BSP Male

Adaptateur mâle ORFS - mâle BSP

Adattatore maschio ORFS-BSP

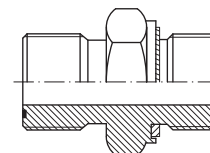

THREAD ROSCA	Part nº Referencia	€	
ORFS 9/16"-18h	BSP 1/4"	ZOR2020404	16,43
ORFS 11/16"-16h	BSP 3/8"	ZOR2020606	20,76
ORFS 13/16"-16h	BSP 1/2"	ZOR2020808	30,26
ORFS 1"3/16-12h	BSP 3/4"	ZOR2021212	42,41
ORFS 1"7/16-12h	BSP 1"	ZOR2021616	54,52
ORFS 1"11/16-12h	BSP 1" 1/4	ZOR2022020	88,55
ORFS 2"-12h	BSP 1" 1/2	ZOR2022424	129,77

Adaptadores ORFS

ORFS Adaptors
Adaptateurs ORFS
Adattatori ORFS

Adaptador macho ORFS-macho Métrico

ORFS Male - Metric Male

Adaptateur mâle ORFS - mâle Métrique

Maschio ORFS Metrico

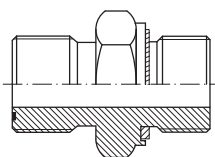

THREAD ROSCA		Part nº Referencia	€
ORFS 9/16"-18h	M12x1.5	ZOR10170412	19,02
ORFS 11/16"-16h	M16x1.5	ZOR10170616	23,07
ORFS 13/16"-16h	M18x1.5	ZOR10170818	33,62
ORFS 1"-14h	M22x1.5	ZOR10171022	47,11
ORFS 1"7/16-12h	M33x2	ZOR10171633	60,57
ORFS 1"11/16-12h	M42x2	ZOR10172042	98,38
ORFS 2"-12h	M48x2	ZOR10172448	144,19

Pasatabiques ORFS

ORFS Bulkhead

Passe-cloison ORFS

Passaparete ORFS

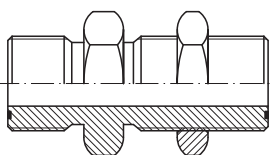

THREAD ROSCA	Part nº Referencia	€
ORFS 9/16"-18h	ZOR1060404	28,78
ORFS 11/16"-16h	ZOR1060606	39,02
ORFS 13/16"-16h	ZOR1060808	49,60
ORFS 1"-14h	ZOR1061010	86,69
ORFS 1"3/16-12h	ZOR1061212	96,03
ORFS 1"7/16-12h	ZOR1061616	115,20
ORFS 1"11/16-12h	ZOR1062020	140,20
ORFS 2"-12h	ZOR1062424	175,45

Adaptador macho-hembra giratoria ORFS

ORFS Male - ORFS Swivel female

Adaptateur mâle - femelle tournante ORFS

Adattatore femmina girevole ORFS-maschio ORFS

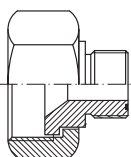

THREAD ROSCA		Part nº Referencia	€
F ORFS 9/16"-18h	M ORFS 11/16"-16h	ZOR3010406	*
F ORFS 11/16"-16h	M ORFS 9/16"-18h	ZOR3010604	25,57
F ORFS 13/16"-16h	M ORFS 9/16"-18h	ZOR3010804	27,40
F ORFS 13/16"-16h	M ORFS 11/16"-16h	ZOR3010806	26,48
F ORFS 1"-14h	M ORFS 9/16"-18h	ZOR3011004	39,04
F ORFS 1"-14h	M ORFS 11/16"-16h	ZOR3011006	36,15
F ORFS 1"-14h	M ORFS 13/16"-16h	ZOR3011008	34,42
F ORFS 1"3/16-12h	M ORFS 11/16"-16h	ZOR3011206	67,36
F ORFS 1"3/16-12h	M ORFS 13/16-16h	ZOR3011208	63,33
F ORFS 1"3/16-12h	M ORFS 1"-14h	ZOR3011210	60,88
F ORFS 1"7/16-12h	M ORFS 13/16"-16h	ZOR3011608	74,35
F ORFS 1"7/16-12h	M ORFS 1"-14h	ZOR3011610	72,11
F ORFS 1"11/16-12h	M ORFS 1"3/16-12h	ZOR3012012	68,50
F ORFS 1"11/16-12h	M ORFS 1"7/16-12h	ZOR3012016	92,58

Adaptador macho ORFS-macho JIC 37°

ORFS Male - 37° JIC Male

Adaptateur mâle ORFS - mâle JIC 37°

Adattatore maschio ORFS-JIC

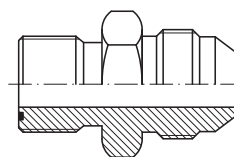

THREAD ROSCA		Part nº Referencia	€
ORFS 9/16"-18h	JIC 7/16"	ZOR2040404	16,81
ORFS 11/16"-16h	JIC 9/16"	ZOR2040606	18,69
ORFS 13/16"-16h	JIC 3/4"	ZOR2040808	20,58
ORFS 1"-14h	JIC 7/8"	ZOR2041010	22,39
ORFS 1"3/16-12h	JIC 1"1/16	ZOR2041212	27,52
ORFS 1"7/16-12h	JIC 1"5/16	ZOR2041616	45,16
ORFS 1"11/16"-12h	JIC 1"5/8	ZOR2042020	70,04
ORFS 2"-12h	JIC 1"7/8	ZOR2042424	100,27

Adaptador macho ORFS-hembra giratoria JIC 37°

ORFS Male - 37° JIC Swivel female

Adaptateur mâle ORFS - femelle tournante JIC 37°

Adattatore maschio ORFS-femmina girevole JIC

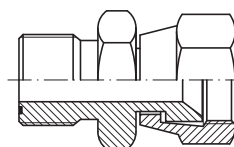

THREAD ROSCA		Part nº Referencia	€
ORFS 9/16"-18h	JIC 7/16"	ZOR3020404	21,05
ORFS 11/16"-16h	JIC 9/16"	ZOR3020606	22,65
ORFS 13/16"-16h	JIC 3/4"	ZOR3020808	24,97
ORFS 1"-14h	JIC 7/8"	ZOR3021010	32,64
ORFS 1"3/16-12h	JIC 1"1/16	ZOR3021212	40,31
ORFS 1"7/16-12h	JIC 1"5/16	ZOR3021616	54,48
ORFS 1"11/16-12h	JIC 1"5/8	ZOR3022020	68,52
ORFS 2"-12h	JIC 1"7/8	ZOR3022424	80,43

Adaptador macho JIC 37°-hembra giratoria ORFS

JIC Male - ORFS Swivel female

Adaptateur mâle JIC 37° - femelle tournante ORFS

Adattatore maschio JIC 37° -femmina girevole ORFS

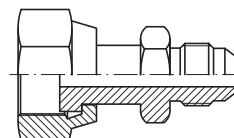

THREAD ROSCA		Part nº Referencia	€
JIC 7/16"	ORFS 9/16"-18h	ZOR3050404	22,65
JIC 9/16"	ORFS 11/16"-16h	ZOR3050606	23,80
JIC 3/4"	ORFS 13/16"-16h	ZOR3050808	26,30
JIC 7/8"	ORFS 1"-14h	ZOR3051010	35,80
JIC 1"1/16	ORFS 1"3/16"-12h	ZOR3051212	43,10
JIC 1"5/16"	ORFS 1"7/16"-12h	ZOR3051616	57,60
JIC 1"5/8	ORFS 1"11/16"-12h	ZOR3052020	70,80
JIC 1"7/8"	ORFS 2"-12h	ZOR3052424	86,80

Adaptadores ORFS

ORFS Adaptors
Adaptateurs ORFS
Adattatori ORFS

Codo 90° macho-macho ORFS

90° ORFS male - ORFS male

Coude 90° mâle ORFS - mâle ORFS

Raccordo a 90° maschio-ORFS

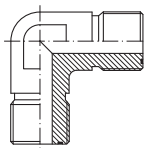

THREAD ROSCA		Part nº Referencia	€
ORFS 9/16"-18h	ORFS 9/16"-18h	ZOR4050404	31,06
ORFS 11/16"-16h	ORFS 11/16"-16h	ZOR4050606	38,29
ORFS 13/16"-16h	ORFS 13/16"-16h	ZOR4050808	53,22
ORFS 1"-14h	ORFS 1"-14h	ZOR4051010	58,19
ORFS 1"3/16-12h	ORFS 1"3/16-12h	ZOR4051212	67,16
ORFS 1"7/16-12h	ORFS 1"7/16-12h	ZOR4051616	93,92
ORFS 1"11/16-12h	ORFS 1"11/16-12h	ZOR4052020	141,29
ORFS 2"-12h	ORFS 2"-12h	ZOR4052424	171,95

Codo 90° macho-hembra giratoria ORFS

90° ORFS swivel female - ORFS male

Coude 90° femelle tournante ORFS- mâle ORFS

Raccordo a 90° maschio-femmina girevole ORFS

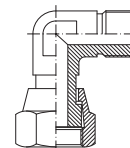

THREAD ROSCA		Part nº Referencia	€
M ORFS 9/16"-18h	F ORFS 9/16"-18h	ZOR6000404	47,12
M ORFS 11/16"-16h	F ORFS 11/16"-16h	ZOR6000606	58,92
M ORFS 13/16"-16h	F ORFS 13/16"-16h	ZOR6000808	77,10
M ORFS 1"-14h	F ORFS 1"-14h	ZOR6001010	86,48
M ORFS 1"3/16-12h	F ORFS 1"3/16-12h	ZOR6001212	107,00
M ORFS 1"7/16-12h	F ORFS 1"7/16-12h	ZOR6001616	121,94
M ORFS 1"11/16-12h	F ORFS 1"11/16-12h	ZOR6002020	149,90

TE macho-macho-macho ORFS

ORFS Male Tee

Té Mâle ORFS

Raccordo a T maschio ORFS

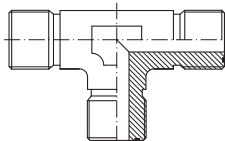

THREAD ROSCA	Part nº Referencia	€
ORFS 9/16"18h	ZOR7000404	42,07
ORFS 11/16"-16h	ZOR7000606	44,27
ORFS 13/16"-16h	ZOR7000808	57,94
ORFS 1"-14h	ZOR7001010	64,96
ORFS 1"3/16-12h	ZOR7001212	74,42
ORFS 1"7/16-12h	ZOR7001616	131,90
ORFS 1"11/16-12h	ZOR7002020	160,22
ORFS 2"-12h	ZOR7002424	211,41

TE macho-macho-hembra giratoria ORFS

ORFS Male-Male-Swivel Female Tee

Té Mâle-Mâle-Femelle tournante ORFS

Raccordo a T maschio-maschio-femmina girevole laterale ORFS

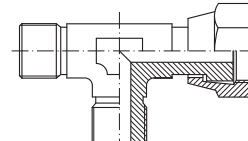

THREAD ROSCA	Part nº Referencia	€
ORFS 9/16"-18h	ZOR7020404	71,35
ORFS 11/16"-16h	ZOR7020606	72,94
ORFS 13/16"-16h	ZOR7020808	80,08
ORFS 1"-14h	ZOR7021010	115,12
ORFS 1"3/16-12h	ZOR7021212	138,56
ORFS 1"7/16-12h	ZOR7021616	187,15
ORFS 1" 11/16-12h	ZOR7022020	201,84

TE macho-hembra giratoria-macho ORFS

ORFS Male-Swivel female-Male Tee

Té Mâle-Femelle tournante-Mâle ORFS

Raccordo a T maschio-femmina girevole centrale-maschio ORFS

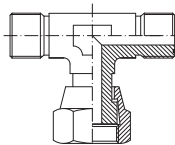

THREAD ROSCA	Part nº Referencia	€
ORFS 9/16"-18h	ZOR7010404	71,35
ORFS 11/16"-16h	ZOR7010606	72,94
ORFS 13/16"-16h	ZOR7010808	80,08
ORFS 1"-14h	ZOR7011010	115,12
ORFS 1"3/16-12h	ZOR7011212	138,56
ORFS 1"7/16-12h	ZOR7011616	187,15
ORFS 1"11/16-12h	ZOR7012020	201,84
ORFS 2"-12h	ZOR7012424	239,46

Juntas tóricas FKM verde para rosca ORFS

O'ring FKM green for ORFS thread

Joint torique FKM vert pour filetage ORFS

Guarnizione FKM verde per filetto ORFS



THREAD ROSCA	Part nº Referencia	€
ORFS 9/16"-18h	JVORFS04	0,45
ORFS 11/16"-16h	JVORFS06	0,50
ORFS 13/16"-16h	JVORFS08	0,56
ORFS 1"-14h	JVORFS10	0,63
ORFS 1"3/16-12h	JVORFS12	0,85
ORFS 1"7/16-12h	JVORFS16	1,33
ORFS 1" 11/16-12h	JVORFS20	1,67
ORFS 2"-12h	JVORFS24	1,99

MEJORAS CONTINUAS EN EL ÁREA TÉCNICA

TECHNICAL DEPARTMENT MAKES THINGS BETTER

NUEVO MEDIOS
NEW MACHINES



Banco de pruebas minicentrales
Minipower Packs Test bench

Reparación máquinas de prensar
Crimping machines reparation

Cortadora orbital
Orbital cutting machine

Enrolladora packs manguera
Hose packs winder

Embaladora tubo
Tube wrapping machine

- ✓ Diseño propio, proceso de mejora continua
- ✓ Piezas especiales para clientes según especificaciones o muestras
- ✓ Catálogos técnicos y fichas técnicas de productos
- ✓ Asesoría técnica en Conducciones y Componentes Hidráulicos
- ✓ Diseño de grupos hidráulicos y búsqueda de soluciones de aprovisionamiento
- ✓ Asesoramiento para fabricantes de maquinaria en kits de primeros equipos

- ✓ Own design, continual improvement process
- ✓ Special products for customers according to specifications or samples
- ✓ Technical Catalogues and price lists
- ✓ Technnical advising in Hydraulic and Pneumatic Conducts
- ✓ Hydraulic groups design and search of supply solutions
- ✓ Technical support for O.E.M. (Original Equipment Manufacturer)

IMPRESIÓN 3D
3D PRINT

PLANO
DRAW

DISEÑO 3D
3D DESIGN

PROTOTIPO
PROTOTYPE

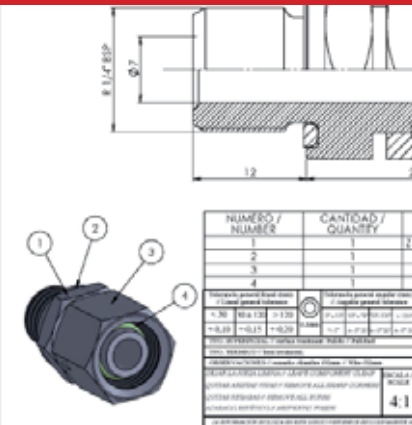

Racores soldables

Welding fittings

Raccords à souder

Raccordi a saldare

Racores para soldar

Welding fittings

Raccords à souder

Raccordi a saldare

165

5

Racores para soldar

Welding fittings
Raccords à souder
Raccordi a saldare

Racores macho para soldar / Welding Male / Raccords mâle à souder / Maschio a saldare

| 165

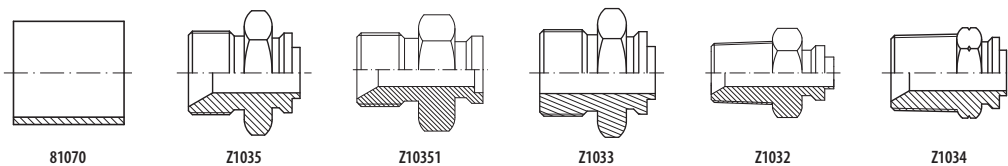

Racores BSP para soldar / Welding BSP nuts / Écrous tournants à souder / Raccordi BSP a saldare

| 166

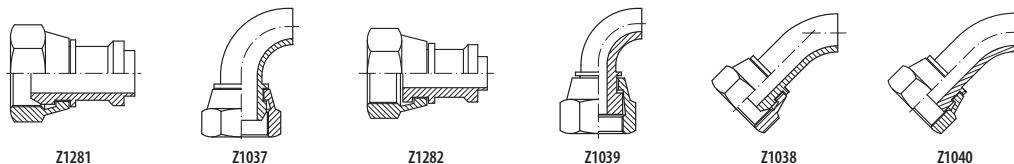

Racores JIC para soldar / Welding JIC fittings / Raccords JIC à souder / Raccordi JIC a saldare

| 167

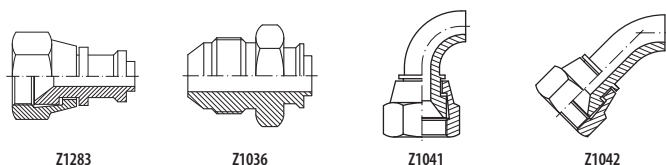

Racores Métricos para soldar / Welding metric fittings / Raccords métriques à souder / Raccordi metrici a saldare

| 167

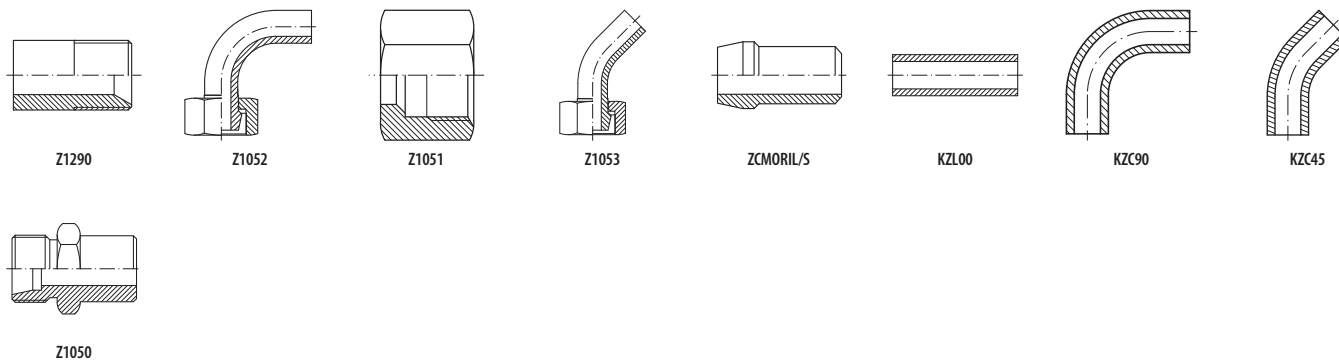

Racores para soldar >2" / Welding fittings >2" / Raccords à souder >2" / Raccordi a saldare >2"

| 170

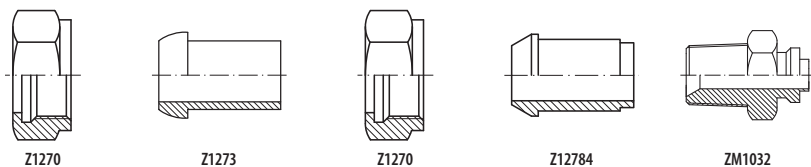

Racores Microfundido para soldar / Welding fittings microcast / Raccords à souder micro-moulés / Raccordi per saldatura microfuso

| 171

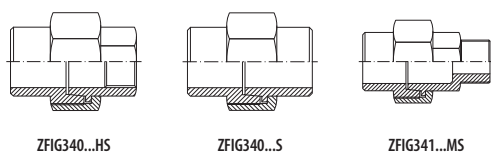

Racores para soldar varios BSP / Other welding fittings BSP / Autres raccords à souder BSP / Raccordi a saldare vari BSP

| 172

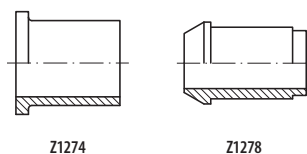

Racores para soldar

Welding fittings
Raccords à souder
Raccordi a saldare

■ Racores para soldar varios JIC / Other welding fittings JIC / Autres raccords à souder JIC / Raccordi a saldare vari JIC

| 172

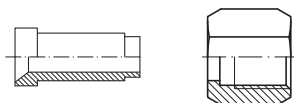

Z1277

Z5110

■ Bidas fijas para soldar / Fixed Forged flanges / Brides DIN à souder fixes / Flange a saldare

| 173

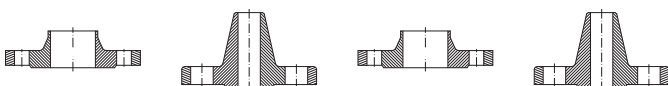

ZBPN162633

ZBANSAWN150

ZBPN402635

ZBANSAWN300

■ Conjunto brida DIN 2642 / DIN 2642 swivel flanges set / Ensemble brides tournantes DIN 2642 / Flangia girevole DIN 2642

| 174

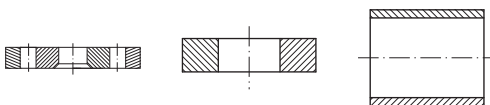

ZBPN102642

ZABAR02642

ZBTUBO

■ Conjunto brida DIN 2656 / DIN 2656 swivel flanges set / Ensemble brides tournantes DIN 2656 / Flangia girevole DIN 2656

| 175

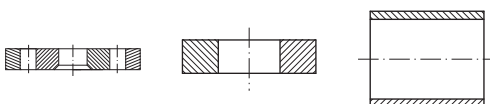

ZBPN402656

ZABAR02656

ZBTUBO

■ Conjunto bidas ANSI-ASA / ANSI-ASA swivel flanges set / Ensemble brides ANSI-ASA / Flangia girevole ANSI-ASA

| 176

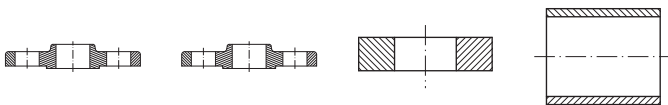

ZBANSAS0150

ZBANSAS0300

ZABAROANSA

ZBTUBO

MONTAJE DE LATIGUILLOS

MOUNTING FLEXIBLES



Racores para soldar

Welding fittings
Raccords à souder
Raccordi a saldare

Casquillo soldable

Welding ferrule

Jupe à souder

Boccola a saldare

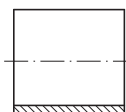

DN	Ø INNER Ø INT.	Part n° Referencia	€
1/4"	14	810700400	1,62
1/4"	12	810700401	1,62
3/8"	19	810700600	2,52
3/8"	17	810700601	1,85
1/2"	22	810700800	2,37
1/2"	19	810700801	2,37
5/8"	25	810701000	2,75
3/4"	30	810701200	2,92
3/4"	32	810701201	3,20
1"	35	810701500	5,40
1"	38	810701600	5,40
1 1/4"	47,8	810702000	6,15
1 1/4"	44,3	810702001	6,15
1 1/2"	56,1	810702400	7,19
2"	66	810703201	12,60
2 1/2"	84,8	810704000	21,63
2 1/2"	95,6	810704001	21,63
3"	100	810704801	26,26
4"	125	810706400	34,13

Macho soldable BSP cono 60° con guía

Welding BSP 60° Male with guide

Mâle gaz BSP 60° à souder avec guide

Maschio a saldare BSP 60° con guida

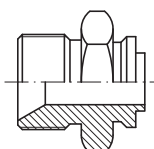

DN	THREAD ROSCA	Part n° Referencia	€
1/4"	1/4" BSP	Z103504	9,97
3/8"	3/8" BSP	Z103506	11,89
1/2"	1/2" BSP	Z103508	12,58
3/4"	3/4" BSP	Z103512	17,72
1"	1" BSP	Z103516	26,75
1 1/4"	1 1/4" BSP	Z103520	45,41
1 1/2"	1 1/2" BSP	Z103524	48,06
2"	2" BSP	Z103532	73,68

Macho BSP 60° soldable interior

Welding interior BSP Male

Mâle à souder int. BSP inox

Maschio BSP 60° a saldare interno

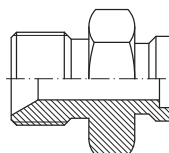

DN	THREAD ROSCA	Part n° Referencia	€
1/4"	1/4" BSP	Z1035104	12,17
3/8"	3/8" BSP	Z1035106	13,67
1/2"	1/2" BSP	Z1035108	16,77
3/4"	3/4" BSP	Z1035112	19,86
1"	1" BSP	Z1035116	27,72
1 1/4"	1 1/4" BSP	Z1035120	50,00
1 1/2"	1 1/2" BSP	Z1035124	57,94
2"	2" BSP	Z1035132	84,55

Macho soldable BSP asiento plano con guía

Welding BSP Male flat seat with guide

Mâle gaz BSP fond plat à souder avec guide

Maschio a saldare BSP faccia piana con guida

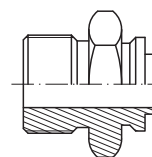

DN	THREAD ROSCA	Part n° Referencia	€
1/4"	1/4" BSP	Z103304	11,73
3/8"	3/8" BSP	Z103306	12,67
1/2"	1/2" BSP	Z103308	14,39
3/4"	3/4" BSP	Z103312	21,24
1"	1" BSP	Z103316	28,09
1 1/4"	1 1/4" BSP	Z103320	43,33
1 1/2"	1 1/2" BSP	Z103324	55,23
2"	2" BSP	Z103332	86,25

Macho soldable BSPT cono 60° con guía

Welding BSPT Male 60° with guide

Mâle gaz conique à souder 60° avec guide

Maschio conico BSPT 60° con guida

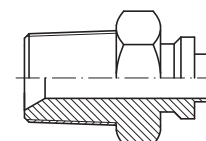

DN	THREAD ROSCA	Part n° Referencia	€
1/4"	1/4" BSPT	Z103204	12,11
3/8"	3/8" BSPT	Z103206	12,08
1/2"	1/2" BSPT	Z103208	13,27
3/4"	3/4" BSPT	Z103212	18,92
1"	1" BSPT	Z103216	25,44
1 1/4"	1 1/4" BSPT	Z103220	41,85
1 1/2"	1 1/2" BSPT	Z103224	49,71
2"	2" BSPT	Z103232	84,61

Macho soldable NPT cono 60° con guía

Welding NPT Male 60° with guide

Mâle NPT à souder 60° avec guide

Maschio a saldare NPT 60° con guida

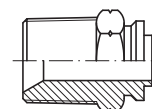

DN	THREAD ROSCA	Part n° Referencia	€
1/4"	1/4" NPT	Z10340400	10,89
3/8"	3/8" NPT	Z10340600	13,53
1/2"	1/2" NPT	Z10340800	13,59
3/4"	3/4" NPT	Z10341200	19,78
1"	1" NPT	Z10341600	28,21
1 1/4"	1 1/4" NPT	Z10342000	47,32
1 1/2"	1 1/2" NPT	Z10342400	54,65
2"	2" NPT	Z10343200	92,74

Racores para soldar

Welding fittings
Raccords à souder
Raccordi a saldare

Hembra giratoria prensada soldable BSP 60° con guía

Welding BSP 60° swept with guide

Femelle tournante BSP 60° à souder avec guide

Femmina girevole a saldare BSP 60° con guida

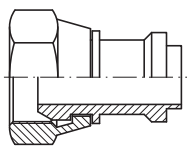

DN	THREAD ROSCA	Part n° Referencia	€
1/4"	1/4" BSP	Z128104	9,79
3/8"	3/8" BSP	Z128106	11,23
1/2"	1/2" BSP	Z128108	13,94
3/4"	3/4" BSP	Z128112	17,37
1"	1" BSP	Z128116	28,49
1"1/4	1"1/4 BSP	Z128120	56,68
1"1/2	1"1/2 BSP	Z128124	76,81
2"	2" BSP	Z128132	107,68

Hembra giratoria 90° prensada soldable BSP 60°

Welding BSP 60° swept 90°

Femelle tournante à souder 90° BSP cône 60°

Femmina girevole 90° a saldare BSP 60°

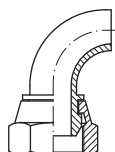

DN	THREAD ROSCA	Part n° Referencia	€
1/4"	1/4" BSP	Z103704	24,15
3/8"	3/8" BSP	Z103706	28,08
1/2"	1/2" BSP	Z103708	33,39
3/4"	3/4" BSP	Z103712	47,00
1"	1" BSP	Z103716	59,16
1"1/4	1"1/4 BSP	Z103720	96,84
1"1/2	1"1/2 BSP	Z103724	136,55
2"	2" BSP	Z103732	147,29

Hembra giratoria prensada soldable BSP asiento plano con guía

Welding BSP flat seat swept with guide

Femelle tournante BSP fond plat à souder avec guide

Femmina girevole a saldare BSP faccia piana con guida

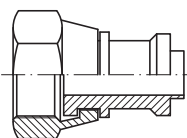

DN	THREAD ROSCA	Part n° Referencia	€
1/4"	1/4" BSP	Z128204	10,12
3/8"	3/8" BSP	Z128206	12,36
1/2"	1/2" BSP	Z128208	13,91
3/4"	3/4" BSP	Z128212	17,40
1"	1" BSP	Z128216	26,10
1"1/4	1"1/4 BSP	Z128220	56,37
1"1/2	1"1/2 BSP	Z128224	76,68
2"	2" BSP	Z128232	107,68

Hembra giratoria 90° prensada soldable BSP asiento plano

Welding BSP Female 90° flat seat

Femelle tournante à souder 90° BSP fond plat

Femmina 90° girevole a saldare BSP faccia piana



DN	THREAD ROSCA	Part n° Referencia	€
1/4"	1/4" BSP	Z103904	25,32
3/8"	3/8" BSP	Z103906	26,21
1/2"	1/2" BSP	Z103908	31,57
3/4"	3/4" BSP	Z103912	52,54
1"	1" BSP	Z103916	55,15
1"1/4	1"1/4 BSP	Z103920	92,14
1"1/2	1"1/2 BSP	Z103924	150,21
2"	2" BSP	Z103932	162,02

Hembra giratoria 45° prensada soldable BSP 60°

Welding BSP 60° swept 45°

Femelle tournante à souder 45° BSP cône 60°

Femmina girevole 45° a saldare BSP 60°

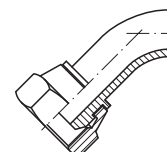

DN	THREAD ROSCA	Part n° Referencia	€
1/4"	1/4" BSP	Z103804	26,99
3/8"	3/8" BSP	Z103806	31,01
1/2"	1/2" BSP	Z103808	36,96
3/4"	3/4" BSP	Z103812	46,85
1"	1" BSP	Z103816	61,37
1"1/4	1"1/4 BSP	Z103820	106,76
1"1/2	1"1/2 BSP	Z103824	124,01
2"	2" BSP	Z103832	145,00

Hembra giratoria 45° prensada soldable BSP asiento plano

Welding BSP Female 45° flat seat

Femelle tournante à souder 45° BSP fond plat

Femmina 45° girevole a saldare BSP faccia piana

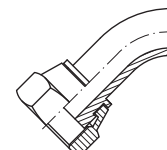

DN	THREAD ROSCA	Part n° Referencia	€
1/4"	1/4" BSP	Z104004	23,80
3/8"	3/8" BSP	Z104006	24,60
1/2"	1/2" BSP	Z104008	30,41
3/4"	3/4" BSP	Z104012	48,11
1"	1" BSP	Z104016	51,35
1"1/4	1"1/4 BSP	Z104020	87,74
1"1/2	1"1/2 BSP	Z104024	136,41
2"	2" BSP	Z104032	159,50

Racores para soldar

Welding fittings
Raccords à souder
Raccordi a saldare

Hembra giratoria prensada soldable JIC 37° con guía

Welding JIC swivel female 37° with guide

Femelle tournante JIC 37° à souder avec guide

Femmina girevole a saldare JIC 37°

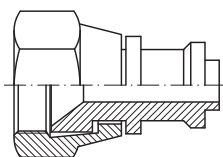

DN	THREAD ROSCA	Part n° Referencia	€
1/4"	7/16" 20h UNF	Z12830704	13,78
1/4"	1/2" 20h UNF	Z12830804	13,91
3/8"	9/16" 18h UNF	Z12830906	15,20
3/8"	3/4" 16h UNF	Z12831206	16,89
1/2"	3/4" 16h UNF	Z12831208	16,65
1/2"	7/8" 14h UNF	Z12831408	18,27
3/4"	1" 1/16 12h UN	Z12831712	21,97
1"	1" 5/16 12h UN	Z12832116	30,39
1" 1/4	1" 5/8 12h UN	Z12832620	56,34
1" 1/2	1" 7/8 12h UN	Z12833024	83,49

Macho soldable JIC 37° con guía

Welding fixed male JIC 37° with guide

Mâle à souder JIC 37° avec guide

Maschio JIC 37° a saldare

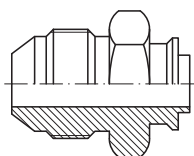

DN	THREAD ROSCA	Part n° Referencia	€
1/4"	7/16" 20h UNF	Z10360704	11,11
1/4"	1/2" 20h UNF	Z10360804	11,66
3/8"	9/16" 18h UNF	Z10360906	14,18
3/8"	3/4" 16h UNF	Z10361206	14,28
1/2"	3/4" 16h UNF	Z10361208	15,48
1/2"	7/8" 14h UNF	Z10361408	17,92
5/8"	7/8" 14h UNF	Z10361410	18,81
3/4"	1" 1/16 12h UN	Z10361712	19,01
1"	1" 5/16 12h UN	Z10362116	30,83
1" 1/4	1" 5/8 12h UN	Z10362620	48,75
1" 1/4	1" 7/8 12h UN	Z10363020	70,02

Empalme liso soldable macho BSP 60°

Welding union male BSP 60°

Embout mâle lisse à souder BSP cône 60°

Mezzo Niples tondo maschio a saldare BSP 60°

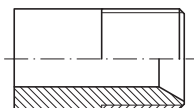

DN	THREAD ROSCA	Part n° Referencia	€
1/8"	1/8" BSP	Z129002	*
1/4"	1/4" BSP	Z129004	7,26
3/8"	3/8" BSP	Z129006	7,03
1/2"	1/2" BSP	Z129008	10,12
3/4"	3/4" BSP	Z129012	16,86
1"	1" BSP	Z129016	25,24
1" 1/4	1" 1/4 BSP	Z129020	45,39
1" 1/2	1" 1/2 BSP	Z129024	67,49
2"	2" BSP	Z129032	102,43

Hembra giratoria 90° prensada soldable JIC 37°

Welding 90° JIC Female 37°

Femelle tournante à souder 90° JIC 37°

Femmina 90° girevole a saldare JIC



DN	THREAD ROSCA	Part n° Referencia	€
1/4"	7/16" 20h UNF	Z10410704	23,02
1/4"	1/2" 20h UNF	Z10410804	23,49
3/8"	9/16" 18h UNF	Z10410906	23,83
1/2"	3/4" 16h UNF	Z10411208	23,78
1/2"	7/8" 14h UNF	Z10411408	26,42
3/4"	1" 1/16 12h UN	Z10411712	45,06
1"	1" 5/16 12h UN	Z10412116	60,17
1" 1/4	1" 5/8 12h UN	Z10412620	100,52
1" 1/2	1" 7/8 12h UN	Z10413024	163,86

Hembra giratoria 45° prensada soldable JIC 37°

Welding 45° JIC Female 37°

Femelle tournante à souder 45° JIC 37°

Femmina 45° girevole a saldare JIC

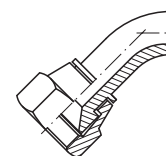

DN	THREAD ROSCA	Part n° Referencia	€
1/4"	7/16" 20h UNF	Z10420704	24,86
1/4"	1/2" 20h UNF	Z10420804	25,37
3/8"	9/16" 18h UNF	Z10420906	25,74
1/2"	3/4" 16h UNF	Z10421208	25,68
1/2"	7/8" 14h UNF	Z10421408	28,53
3/4"	1" 1/16 12h UN	Z10421712	48,67
1"	1" 5/16 12h UN	Z10422116	64,98
1" 1/4	1" 5/8 12h UN	Z10422620	108,56
1" 1/2	1" 7/8 12h UN	Z10423024	176,97

Racores para soldar

Welding fittings
Raccords à souder
Raccordi a saldare

Hembra giratoria 90° soldable métrica

Weldable metrical swivel female 90°

Femelle tournante 90° métrique à souder

Femmina girevole 90° metrica a saldare

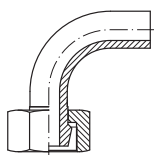

PIPE TUBO	THREAD ROSCA	Part n° Referencia	€
6	M12X1.5	Z10521206	21,83
8	M14X1.5	Z10521408	22,44
8	M16X1.5	Z10521610	30,53
8	M18X1.5	Z10521812	23,45
14	M22X1.5	Z10522215	28,93
18	M26X1.5	Z10522618	43,83
20	M30X2	Z10523022	52,06
25	M36X2	Z10523628	73,76
30	M45X2	Z10524535	134,44
38	M52X2	Z10525242	177,69
6	M14X1.5	Z10521406	22,84
8	M16X1.5	Z10521608	23,54
8	M18X1.5	Z10521810	23,68
8	M20X1.5	Z10522012	32,59
8	M22X1.5	Z10522214	28,63
14	M24X1.5	Z10522416	40,81
18	M30X2	Z10523020	49,72
25	M36X2	Z10523625	75,35
25	M42X2	Z10524230	110,82
30	M52X2	Z10525238	168,68

Tuercas Métricas

DIN nut

Écrou DIN

Dado DIN

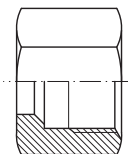

PIPE TUBO	THREAD ROSCA	Part n° Referencia	€
6	M12X1.5	Z10510612	2,09
6	M14X1.5	Z10510614	2,68
8	M14X1.5	Z10510814	2,31
8	M16X1.5	Z10510816	3,02
10	M16X1.5	Z10511016	2,86
10	M18X1.5	Z10511018	3,41
12	M18X1.5	Z10511218	3,31
12	M20X1.5	Z10511220	3,91
14	M22X1.5	Z10511422	6,21
15	M22X1.5	Z10511522	4,55
16	M24X1.5	Z10511624	7,12
18	M26X1.5	Z10511826	6,92
20	M30X2	Z10512030	10,89
22	M30X2	Z10512230	9,13
25	M36X2	Z10512536	25,67
28	M36X2	Z10512836	20,17
30	M42X2	Z10513042	32,71
35	M45X2	Z10513545	28,54
38	M52X2	Z10513852	50,14
42	M52X2	Z10514252	35,96

Hembra giratoria 45° soldable métrica

Weldable metrical swivel female 45°

Femelle tournante 45° métrique à souder

Femmina girevole 45° metrica a saldare

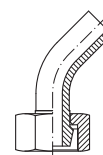

PIPE TUBO	THREAD ROSCA	Part n° Referencia	€
6	M12X1.5	Z10531206	23,58
8	M14X1.5	Z10531408	24,24
10	M16X1.5	Z10531610	24,88
12	M18X1.5	Z10531812	25,32
15	M22X1.5	Z10532215	31,24
18	M26X1.5	Z10532618	47,34
22	M30X2	Z10533022	56,22
28	M36X2	Z10533628	79,66
35	M45X2	Z10534535	145,20
42	M52X2	Z10535242	191,90
6	M14X1.5	Z10531406	24,67
8	M16X1.5	Z10531608	25,42
10	M18X1.5	Z10531810	25,57
12	M20X1.5	Z10532012	27,16
14	M22X1.5	Z10532214	30,92
16	M24X1.5	Z10532416	44,07
20	M30X2	Z10533020	53,70
25	M36X2	Z10533625	81,38
38	M52X2	Z10535238	182,18

Boquilla para soldar cono metal

Welding nipple metal cone

Raccord collet cône métallique à souder

Ogiva a saldare senza o'ring

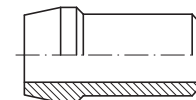

PIPE TUBO	SERIE	Part n° Referencia	€
8	L	Z CMORIL 8	9,12
10	L	Z CMORIL 10	8,61
12	L	Z CMORIL 12	10,24
15	L	Z CMORIL 15	14,51
18	L	Z CMORIL 18	15,08
22	L	Z CMORIL 22	19,38
28	L	Z CMORIL 28	22,36
35	L	Z CMORIL 35	36,32
42	L	Z CMORIL 42	58,75
16	S	Z CMORIS 16	14,24
20	S	Z CMORIS 20	16,32
25	S	Z CMORIS 25	25,47
30	S	Z CMORIS 30	28,99
38	S	Z CMORIS 38	40,87

En caso de querer la pieza con junta, ver pág.104 / If you want the item with o'ring, please see page 104 / Si vous voulez la pièce avec le joint, voir page 104 / En caso de querer la pieza con junta, ver pág.104

Racores para soldar

Welding fittings
Raccords à souder
Raccordi a saldare

Espiga lisa métrica recta

Welding metric standpipe

Embout lisse métrique à souder



Estremità tubolare metrica diritta

Ø OUTER Ø EXT.	Ø INNER Ø INT.	Part nº Referencia	€
6	4	KZL0006	6,79
8	6	KZL0008	7,49
10	7	KZL0010	7,55
12	9	KZL0012	7,81
14	10	KZL0014	10,77
15	12	KZL0015	10,32
16	12	KZL0016	11,68
18	15	KZL0018	15,26
20	14	KZL0020	18,34
22	18	KZL0022	19,58

Espiga lisa métrica 90°

Welding metric standpipe 90°

Embout lisse métrique 90° à souder

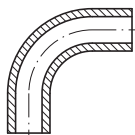

Estremità tubolare metrica a 90°

Ø OUTER Ø EXT.	Ø INNER Ø INT.	Part nº Referencia	€
6	4	KZC9006	6,00
8	4	KZC9008	8,19
10	6	KZC9010	9,02
12	8	KZC9012	11,20
14	10	KZC9014	13,27
15	11	KZC9015	14,40
16	11	KZC9016	16,70
18	14	KZC9018	19,31
20	12	KZC9020	22,37
22	18	KZC9022	26,51

Espiga lisa métrica 45°

Welding metric standpipe 45°

Embout lisse métrique 45° à souder

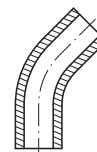

Estremità tubolare metrica a 45°

Ø OUTER Ø EXT.	Ø INNER Ø INT.	Part nº Referencia	€
6	4	KZC4506	6,00
8	4	KZC4508	8,19
10	6	KZC4510	9,02
12	8	KZC4512	11,20
14	10	KZC4514	13,27
15	11	KZC4515	14,40
16	11	KZC4516	16,70
18	14	KZC4518	19,31
20	12	KZC4520	22,37
22	18	KZC4522	26,51

Macho soldable Métrico

Welding DIN Male

Mâle à souder métrique

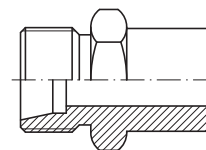

Maschio saldare DIN

PIPE TUBO	SERIE	Part nº Referencia	€
6	L	Z1050L06	5,72
8	L	Z1050L08	6,86
10	L	Z1050L10	7,21
12	L	Z1050L12	8,82
15	L	Z1050L15	10,90
18	L	Z1050L18	18,42
22	L	Z1050L22	24,39
28	L	Z1050L28	28,83
35	L	Z1050L35	40,59
42	L	Z1050L42	63,58
6	S	Z1050S06	7,99
8	S	Z1050S08	10,13
10	S	Z1050S10	10,23
12	S	Z1050S12	12,13
14	S	Z1050S14	18,11
16	S	Z1050S16	18,96
20	S	Z1050S20	23,03
25	S	Z1050S25	31,83
30	S	Z1050S30	45,27
38	S	Z1050S38	73,22

Racores para soldar

Welding fittings
Raccords à souder
Raccordi a saldare

Tuerca cono ajuste BSP

BSP Nut for welding nipple 60° cone

Écrou gaz pour collet à souder

Dado BSP per ogiva a saldare cono 60°

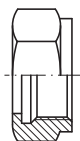

THREAD ROSCA	Part n° Referencia	€
1/4" BSP	Z127004	4,08
3/8" BSP	Z127006	4,74
1/2" BSP	Z127008	5,60
3/4" BSP	Z127012	8,32
1" BSP	Z127016	15,36
1"1/4 BSP	Z127020	29,61
1"1/2 BSP	Z127024	34,55
2" BSP	Z127032	48,72

Cono ajuste BSP 60°

Welding nipple BSP 60°

Collet à souder BSP cone 60°

Ogiva a saldare BSP

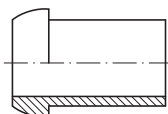

THREAD ROSCA	Ø OUTER Ø EXT.	Part n° Referencia	€
1/4" BSP	9	Z127304	3,34
3/8" BSP	13	Z127306	3,60
1/2" BSP	16	Z127308	5,61
3/4" BSP	21	Z127312	7,42
1" BSP	27	Z127316	10,78
1"1/4 BSP	33	Z127320	18,97
1"1/2 BSP	41.5	Z127324	32,90
2" BSP	52.5	Z127332	41,40

Tuercas BSP Microfundido AISI-316

Micro-casting BSP nuts AISI-316

Écrous BSP en acier moulé AISI-316

Dadi BSP microfusi AISI-316

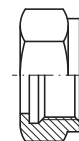

THREAD ROSCA	Part n° Referencia	€
2"1/2 BSP	Z127040	118,40
3" BSP	Z127048	148,54
4" BSP	Z127064	196,98

Cono ajuste BSP 60° con guía

Welding nipple with 60° cone for BSP nut with guide

Collet à souder BSP cone 60° avec guide

Ogiva a saldare cono 60° con guida per dado BSP



DN	THREAD ROSCA	Part n° Referencia	€
2"1/2	2"1/2 BSP	Z127840	94,48
3"	3" BSP	Z127848	117,22
4"	4" BSP	Z127864	171,30

Macho BSPT soldar microfundido AISI-316

Micro-casting BSPT welding male AISI-316

Mâle BSPT à souder en acier moulé AISI-316

Maschio BSPT a saldare microfuso AISI-316

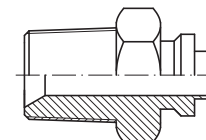

DN	THREAD ROSCA	Part n° Referencia	€
2"1/2	2"1/2 BSPT	ZM103240	124,32
3"	3" BSPT	ZM103248	152,43
4"	4" BSPT	ZM103264	192,43

Racores para soldar

Welding fittings
Raccords à souder
Raccordi a saldare

Crimp fittings for hoses

Pipe fittings DIN 2353

Flare fittings JIC 37° / SAE Flanges

Adaptors

Welding fittings

Industrial fittings

Couplings, Ball valves and Hydraulic Components

Unión 3 piezas hembra-soldar FIG.340HS microfundido

Union 3 fem. welding pieces fig.340hs micro-casting

Union 3 pcs fem. à souder fig.340hs inox acier moulé

Unione a 3 pezzi f.saldare fig.340hs inox microfusione

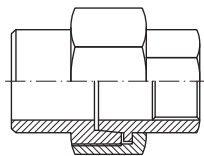

THREAD ROSCA	Part n° Referencia	€
1/4"	ZFIG34004HS	*
3/8"	ZFIG34006HS	*
1/2"	ZFIG34008HS	*
3/4"	ZFIG34012HS	*
1"	ZFIG34016HS	*
1" 1/4	ZFIG34020HS	*
1" 1/2	ZFIG34024HS	*
2"	ZFIG34032HS	*

*Ver precios en p.200 / *See prices p.200 / *Voir prix p.200

Unión 3 piezas macho-soldar FIG.341MS microfundido

Union 3 welding male pieces fig.341ms micro-casting

Union 3 pcs mâle à souder fig.341ms inox acier moulé

Unione a 3 pezzi m.saldare fig.341ms inox microfusione

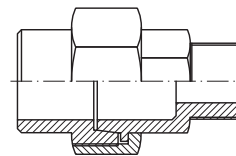

THREAD ROSCA	Part n° Referencia	€
1/4"	ZFIG34104MS	*
3/8"	ZFIG34106MS	*
1/2"	ZFIG34108MS	*
3/4"	ZFIG34112MS	*
1"	ZFIG34116MS	*
1" 1/4	ZFIG34120MS	*
1" 1/2	ZFIG34124MS	*
2"	ZFIG34132MS	*

*Ver precios en p.200 / *See prices p.200 / *Voir prix p.200

Unión 3 piezas soldar FIG.340S microfundido

Union 3 welding pieces fig. 340s micro-casting

Union 3 pièces à souder fig. 340s inox acier moulé

Unione a 3 pezzi a saldare fig.340s inox microfusione

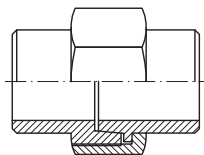

DN	Part n° Referencia	€
1/4	ZFIG34004S	*
3/8	ZFIG34006S	*
1/2	ZFIG34008S	*
3/4	ZFIG34012S	*
1	ZFIG34016S	*
1 1/4	ZFIG34020S	*
1 1/2	ZFIG34024S	*
2	ZFIG34032S	*

*Ver precios en p.200 / *See prices p.200 / *Voir prix p.200

Racores para soldar

Welding fittings
Raccords à souder
Raccordi a saldare

Cono ajuste BSP asiento plano

Welding nipple BSP flat seat

Collet à souder BSP fond plat

Ogiva a saldare sede piana

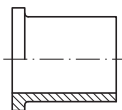

THREAD ROSCA	Ø OUTER Ø EXT.	Part n° Referencia	€
1/4 BSP	9	Z127404	5,31
1/2 BSP	16	Z127408	5,92
1"1/4 BSP	33	Z127420	23,65
3/4 BSP	21	Z127412	8,22
1"1/4 BSP	33	Z127920	23,65

Hasta fin de existencias. Z127920 con guía. / Until end of stock. Z127920 with guide / Jusqu'à fin du stock. Z127920 avec guide. / Fino ad esaurimento scorta. Z127920 con guida

Cono ajuste BSP 60° con guía

Welding nipple with 60° cone for BSP nut with guide

Collet à souder BSP cone 60° avec guide

Ogiva a saldare cono 60° con guida per dado BSP

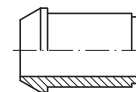

DN	THREAD ROSCA	Part n° Referencia	€
3/8"	3/8" BSP	Z127806	3,17
3/4"	3/4" BSP	Z127812	7,44
1"1/4	1"1/4 BSP	Z127820	22,13

Hasta fin de existencias. Ver H.G. SOLDAR BSP (Z1281...) / Until end of stock. See WELDABLE SWIVEL FEM.BSP (Z1281...) / Jusqu'à la fin du stock. Voir FEM.TOURN.À SOUDER BSP (Z1281...) / Fino ad esaurimento scorta. Vedere FEM. GIREV. BSP SALDARE (Z1281...)

Cono ajuste JIC 37° con guía

Welding nipple for JIC 37° with guide

Collet à souder femelle JIC cone 37° avec guide

Ogiva a saldare cono JIC 37° con guida

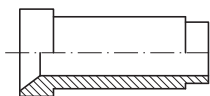

DN	THREAD ROSCA	Part n° Referencia	€
1/4"	7/16" 20h UNF	Z12770704	8,90
1/4"	1/2" 20h UNF	Z12770804	10,25
3/8"	9/16" 18h UNF	Z12770906	9,14
3/8"	3/4" 16h UNF	Z12771206	9,42
1/2"	3/4" 16h UNF	Z12771208	10,00
5/8"	7/8" 14h UNF	Z12771410	10,71
3/4"	1"1/16 12h UN	Z12771712	11,98
1"1/4	1"7/8 12h UN	Z12773020	39,88

Hasta fin de existencias / Until end of stock / Jusqu'à fin du stock / Fino ad esaurimento scorte

Tuercas JIC

JIC nut

Écrou JIC

Dado JIC

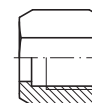

PIPE TUBO	THREAD ROSCA	Part n° Referencia	€
6	1/4	7/16" 20h UNF	ZS11006 *
8	5/16	1/2" 20h UNF	ZS11008 *
10	3/8	9/16" 18h UNF	ZS11010 *
12	1/2	3/4" 16h UNF	ZS11012 *
14-15-16	5/8	7/8" 14h UNF	ZS11016 *
18-20	-	1"1/16 12h UN	ZS11020 *
-	3/4	1"1/16 12h UNF	ZS11020W *
25	1	1"5/16 12h UN	ZS11025 *
30-32	1 1/4	1"5/8 12h UN	ZS11032 *
38	1 1/2	1"7/8 12h UN	ZS11038 *

*Ver precios en p.120 (R. JIC) / *See prices in p.120 (JIC Fittings) / *Prix à la page 120 (R. JIC) / *Vedere prezzi p.120 (R. JIC)

Racores para soldar

Welding fittings
Raccords à souder
Raccordi a saldare

Brida fija soldable PN10/16 DIN 2633

Welding forged flange DIN 2633 PN 10/16

Bride fixe à souder DIN 2633 PN10/16

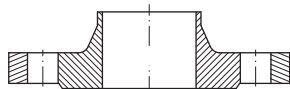

Flangia forgiata a saldare DIN 2633 PN 10/16

DN	Part n° Referencia	€
15-1/2"	ZBPN16263308	36,62
20-3/4"	ZBPN16263312	43,42
25-1"	ZBPN16263316	67,81
32-1"1/4	ZBPN16263320	88,18
40-1"1/2	ZBPN16263324	115,16
50-2"	ZBPN16263332	135,55
65-2"1/2	ZBPN16263340	214,91
80-3"	ZBPN16263348	254,94
100-4"	ZBPN16263364	349,26

Brida fija ANSI-ASA 150 LBS

Flange ANSI-ASA Welding Neck 150 LBS

Bride ANSI-ASA Welding Neck 150 LBS

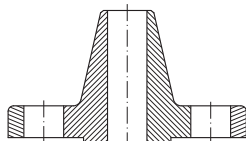

Flangia ANSI-ASA a saldare 150 LBS

DN	Part n° Referencia	€
15-1/2"	ZBANSAWN15008	123,14
20-3/4"	ZBANSAWN15012	154,43
25-1"	ZBANSAWN15016	169,35
32-1"1/4	ZBANSAWN15020	215,57
40-1"1/2	ZBANSAWN15024	277,29
50-2"	ZBANSAWN15032	407,03
65-2"1/2	ZBANSAWN15040	554,56
80-3"	ZBANSAWN15048	678,56
100-4"	ZBANSAWN15064	1.047,70

Brida fija soldable PN40 DIN 2635

Welding forged flange DIN 2635 PN 40

Bride fixe à souder DIN 2635 PN 40

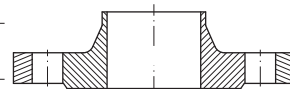

Flangia forgiata a saldare DIN 2635 PN 40

DN	Part n° Referencia	€
10-3/8"	ZBPN40263506 *	45,71
15-1/2"	ZBPN40263508	65,60
20-3/4"	ZBPN40263512	87,33
25-1"	ZBPN40263516	99,94
32-1"1/4	ZBPN40263520	156,24
40-1"1/2	ZBPN40263524	168,41
50-2"	ZBPN40263532	220,45
65-2"1/2	ZBPN40263540	278,57
80-3"	ZBPN40263548	322,01
100-4"	ZBPN40263564	392,91

Brida fija ANSI-ASA 300 LBS

FLANGE ANSI-ASA Welding Neck 300 LBS

Bride ANSI-ASA Welding Neck 300 LBS

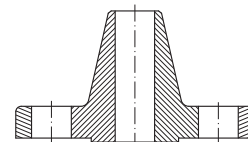

Flangia ANSI-ASA a saldare 300 LBS

DN	Part n° Referencia	€
15-1/2"	ZBANSAWN30008	155,57
20-3/4"	ZBANSAWN30012	215,57
25-1"	ZBANSAWN30016	277,29
32-1"1/4	ZBANSAWN30020	415,92
40-1"1/2	ZBANSAWN30024	554,56
50-2"	ZBANSAWN30032	631,49
65-2"1/2	ZBANSAWN30040	831,84
80-3"	ZBANSAWN30048	1.047,70
100-4"	ZBANSAWN30064	1.740,90

Racores para soldar

Welding fittings
Raccords à souder
Raccordi a saldare

Brida plana PN10 DIN 2642

Welding forged flange DIN 2642 PN 10

Bride tournante à souder DIN 2642 PN 10

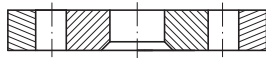

Flangia girevole a saldare DIN 2642 PN 10

DN	Part n° Referencia	€
15-1/2"	ZBPN10264208	35,50
20-3/4"	ZBPN10264212	38,75
25-1"	ZBPN10264216	42,68
32-1 1/4"	ZBPN10264220	61,90
40-1 1/2"	ZBPN10264224	70,92
50-2"	ZBPN10264232	85,36
65-2 1/2"	ZBPN10264240	96,53
10-3/8"	ZBPN10264206 *	33,17
80-3"	ZBPN10264248	133,30
100-4"	ZBPN10264264	164,16

Aro para brida DIN 2642

Ring for flange DIN 2642

Collet épais pour bride DIN 2642

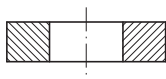

Anello per flangia DIN 2642

DN	Part n° Referencia	€
3/8"	ZABARO264206	21,50
1/2"	ZABARO264208	32,70
3/4"	ZABARO264212	35,43
1"	ZABARO264216	41,03
1 1/4"	ZABARO264220	47,14
1 1/2"	ZABARO264224	55,25
2"	ZABARO264232	77,08
2 1/2"	ZABARO264240	89,92
3"	ZABARO264248	129,68
4"	ZABARO264264	158,40

Tubo para soldar bridas ANSI-DIN

Tube for welding flanges ANSI-DIN

Tube à souder brides ANSI-DIN

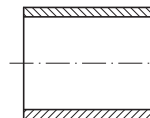

Tube per flangia a saldare ANSI-DIN

DN	Part n° Referencia	€
3/8"	ZBTUBO06	6,03
1/2"	ZBTUBO08	6,35
3/4"	ZBTUBO12	7,90
1"	ZBTUBO16	8,82
1 1/4"	ZBTUBO20	11,20
1 1/2"	ZBTUBO24	14,00
2"	ZBTUBO32	17,94
2 1/2"	ZBTUBO40	19,11
3"	ZBTUBO48	27,05
4"	ZBTUBO64	36,46

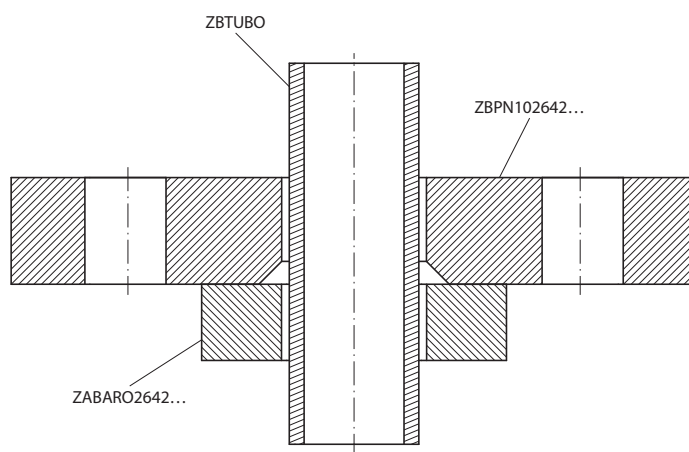

Racores para soldar

Welding fittings
Raccords à souder
Raccordi a saldare

Brida plana PN40 DIN 2656

Welding forged flange DIN 2656 PN 40

Bride tournante à souder DIN 2656 PN 40

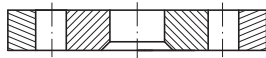

Flangia girevole a saldare DIN 2656 PN 40

DN	Part n° Referencia	€
10-3/8"	ZBPN40265606 *	63,40
15-1/2"	ZBPN40265608	101,04
20-3/4"	ZBPN40265612	121,99
25-1"	ZBPN40265616	164,48
32-1"1/4	ZBPN40265620	241,69
40-1"1/2	ZBPN40265624	211,59
50-2"	ZBPN40265632	259,01
65-2"1/2	ZBPN40265640	335,90
80-3"	ZBPN40265648	400,80
100-4"	ZBPN40265664	663,63

Aro para brida DIN 2656

Ring for flange DIN 2656

Collet épais pour bride DIN 2656

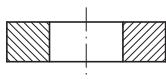

Anello per flangia DIN 2656

DN	Part n° Referencia	€
3/8"	ZABARO265606	12,06
1/2"	ZABARO265608	14,51
3/4"	ZABARO265612	29,39
1"	ZABARO265616	37,87
1"1/4	ZABARO265620	45,21
1"1/2	ZABARO265624	59,53
2"	ZABARO265632	85,33
2"1/2	ZABARO265640	120,19
3"	ZABARO265648	158,61

Tubo para soldar bridas ANSI-DIN

Tube for welding flanges ANSI-DIN

Tube à souder brides ANSI-DIN

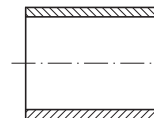

Tubo per flangia a saldare ANSI-DIN

DN	Part n° Referencia	€
3/8"	ZBTUBO06	*
1/2"	ZBTUBO08	*
3/4"	ZBTUBO12	*
1"	ZBTUBO16	*
1"1/4	ZBTUBO20	*
1"1/2	ZBTUBO24	*
2"	ZBTUBO32	*
2"1/2	ZBTUBO40	*
3"	ZBTUBO48	*
4"	ZBTUBO64	*

*Ver precios en p.174 / *See prices p.174 / *Voir prix p.174

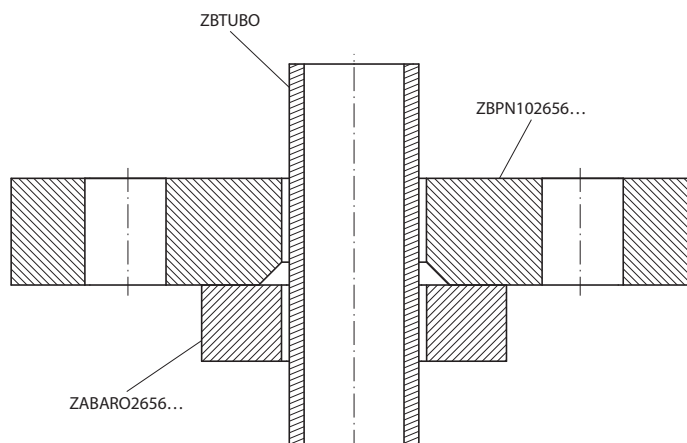

Racores para soldar

Welding fittings
Raccords à souder
Raccordi a saldare

Brida plana ANSI-ASA 150 LBS

Swivel flange ANSI-ASA 150 LBS

Bride tournante ANSI-ASA 150 LBS



Flangia girevole ANSI-ASA 150 LBS

DN	Part n° Referencia	€
15-1/2"	ZBANSASO15008	43,55
20-3/4"	ZBANSASO15012	56,77
25-1"	ZBANSASO15016	71,77
32-1 1/4"	ZBANSASO15020	90,18
40-1 1/2"	ZBANSASO15024	97,60
50-2"	ZBANSASO15032	135,20
65-2 1/2"	ZBANSASO15040	239,26
80-3"	ZBANSASO15048	241,60
100-4"	ZBANSASO15064	333,81

Brida plana ANSI-ASA 300 LBS

Swivel flange ANSI-ASA 300 LBS

Bride tournante ANSI-ASA 300 LBS



Flangia girevole ANSI-ASA 300 LBS

DN	Part n° Referencia	€
15-1/2"	ZBANSASO30008	88,12
20-3/4"	ZBANSASO30012	97,02
25-1"	ZBANSASO30016	103,48
32-1 1/4"	ZBANSASO30020	133,05
40-1 1/2"	ZBANSASO30024	199,07
50-2"	ZBANSASO30032	235,66
65-2 1/2"	ZBANSASO30040	320,91
80-3"	ZBANSASO30048	420,66
100-4"	ZBANSASO30064	712,87

Aro para brida ANSI-ASA

Ring for flange ANSI-ASA

Collet épais pour bride ANSI-ASA



Anello per flangia ANSI-ASA

DN	Part n° Referencia	€
1/2"	ZABAROANSA08	5,88
3/4"	ZABAROANSA12	7,69
1"	ZABAROANSA16	9,20
1 1/4"	ZABAROANSA20	13,87
1 1/2"	ZABAROANSA24	17,93
2"	ZABAROANSA32	30,14
2 1/2"	ZABAROANSA40	31,95
3"	ZABAROANSA48	51,24
4"	ZABAROANSA64	73,24

Tubo para soldar bridas ANSI-DIN

Tube for welding flanges ANSI-DIN

Tube à souder brides ANSI-DIN

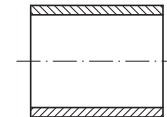

Tubo per flangia a saldare ANSI-DIN

DN	Part n° Referencia	€
3/8"	ZBTUBO06	*
1/2"	ZBTUBO08	*
3/4"	ZBTUBO12	*
1"	ZBTUBO16	*
1 1/4"	ZBTUBO20	*
1 1/2"	ZBTUBO24	*
2"	ZBTUBO32	*
2 1/2"	ZBTUBO40	*
3"	ZBTUBO48	*
4"	ZBTUBO64	*

*Ver precios en p.174 / *See prices p.174 / *Voir prix p.174

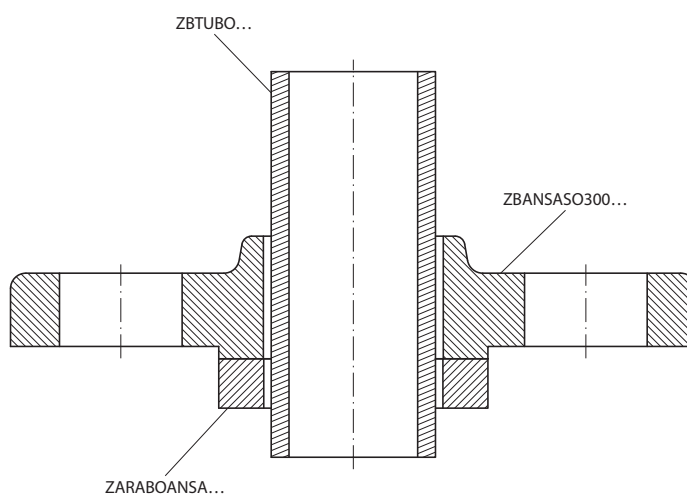
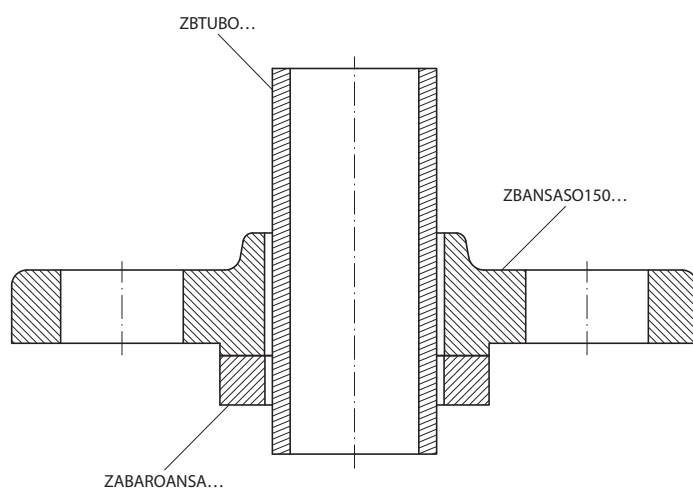

CONDUCCIONES Y COMPONENTES HIDRÁULICAS Y NEUMÁTICAS

HYDRAULIC AND PNEUMATIC CONNECTORS AND COMPONENTS



CONEXIONES FLEXIBLES · FLEXIBLE CONNECTORS



TUBO RÍGIDO · PIPE CONNECTORS



ACCESORIOS · ACCESSORIES



NEUMÁTICA · PNEUMATIC



COMPONENTES HIDRÁULICOS · HYDRAULIC COMPONENTS



TRALE®



Racores industriales

Industrial fittings

Raccords industriels

Raccordi industriali

Industria alimentaria	184
<i>Food industry</i>	
Raccords alimentaires	
<i>Raccordi alimentari</i>	
Camlock	191
<i>Camlock Fittings</i>	
Raccords Camlock	
<i>Camlock</i>	
Acoples GUILLEMIN NF E-29572	193
<i>GUILLEMIN NF E-29572 Fittings</i>	
Raccords GUILLEMIN NF E-29572	
<i>Raccordi GUILLEMIN NF E-29572</i>	
Acoples TW DIN 28450	195
<i>TW DIN 28450 Fittings</i>	
Raccords TW DIN 28450	
<i>Raccordi TW DIN 28450</i>	
Accesorios inox para racor industrial	196
<i>Stainless Steel accessories for industrial fitting</i>	
Accessoires acier inox pour raccord industriel	
<i>Accessorio in acciaio inossidabile per raccordo industriale</i>	
Racores baja presión 150 LBS	197
<i>Screwed fittings low pressure 150 LBS</i>	
Raccords basse pression 150 LBS	
<i>Raccordi bassa pressione 150 LBS</i>	

6

Industria alimentaria

Food industry
Raccords alimentaires
Raccordi alimentari

■ Casquillos para prensar / Crimp ferrules / Jupes à sertir / Boccole a pressare

| 184

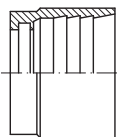

81042

■ Racores SMS / SMS Unions / Raccords SMS / Raccordi SMS

| 185

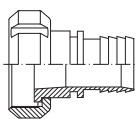

ZRA200

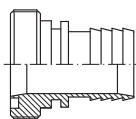

ZRA212

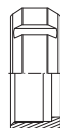

ZSMS H



ZSMS S



ZSMS M



JSMS S



JSMS P

■ Racores Tri-Clamp / Clamp Unions / Raccords Tri-Clamp / Raccordi Tri-Clamp

| 186

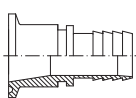

ZTC

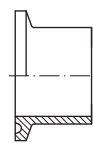

ZC

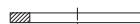

JCLAMPS

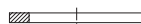

JCLAMPP



ZAC1P

■ Racores DIN 11851 / DIN 11851 Unions / Raccords DIN 11851 / Raccordi DIN 11851

| 187

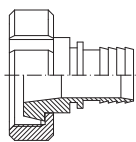

ZRA100

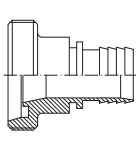

ZRA112



ZDIN H



ZDIN S



ZDIN M

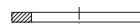

JDIN S

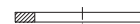

JDIN P

■ Racores Macon / Macon Unions / Raccords Macon / Raccordi Macon

| 188

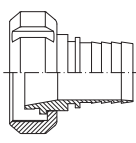

ZRA300

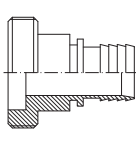

ZRA312



ZMAC H

■ Racores alimentarios para manguera PTFE Serie STD / Food fittings for PTFE hose STD Series / Raccords alimentaires pour tuyau PTFE Série STD / Raccordi alimentari per tubo PTFE Serie STD

| 189

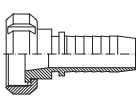

ZRA250

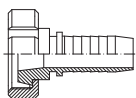

ZRA150

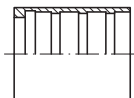

81041

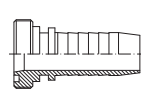

ZRA252

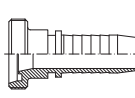

ZRA152

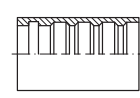

81040

■ Racores alimentarios para manguera PTFE corrugado / Food fittings for convoluted PTFE hose / Raccords alimentaires pour tuyau PTFE convoluté / Raccordi alimentari per tubo PTFE corrugato

| 190

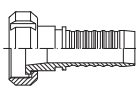

ZRA500

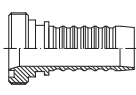

ZRA512

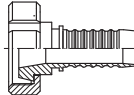

ZRA400

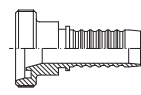

ZRA412

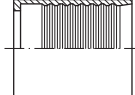

81050

Camlock

Camlock Fittings
Raccords Camlock
Camlock

■ Racores Camlock AISI 316 / Camlock Unions AISI 316 / Raccords Camlock AISI 316 / Raccordi Camlock AISI 316

191

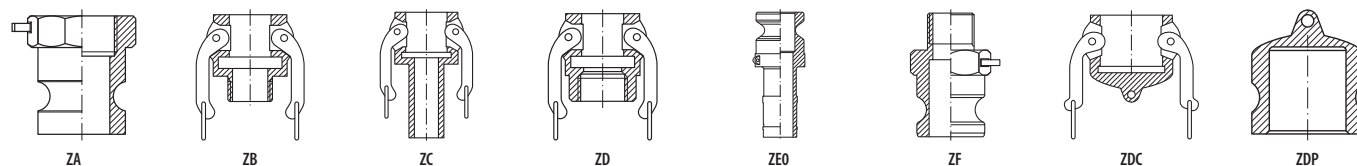

JCAMNBR

JCAMS

Acoples GUILLEMIN NF E-29572

GUILLEMIN NF E-29572 Fittings
Raccords GUILLEMIN NF E-29572
Raccordi GUILLEMIN NF E-29572

■ GUILLEMIN inox / GUILLEMIN Stainless Steel / GUILLEMIN acier inox / GUILLEMIN acciaio inossidabile

193



ZGU06C

Acoples TW DIN 28450

TW DIN 28450 Fittings
Raccords TW DIN 28450
Raccordi TW DIN 28450

■ TW inox / TW Stainless Steel / TW acier inox / TW Acciaio Inossidabile

195



ZMK

ZVK

ZMB

ZVB

ZMKS

ZVKS

Crimp fittings for hoses

Pipe fittings DIN 2353

Flare fittings JIC 37° / SAE Flanges

Adaptors

Welding fittings

Industrial fittings

Couplings, Ball valves and Hydraulic Components

Accesorios inox para racor industrial

Stainless Steel accessories for industrial fitting
Accessoires acier inox pour raccord industriel
Accessorio in acciaio inossidabile per raccordo industriale

■ **Campana inox para racor industrial / Stainless Steel Crimping Ferrule for industrial fitting / Jupe pour raccord industriel acier inox / Boccola in acciaio inossidabile per raccordo industriale**

196



ZCA

■ **Abrazadera inox para racor industrial / Stainless Steel clamp for industrial fitting / Collier pour raccord industriel acier inox / Collare in acciaio inossidabile per raccordo industriale**

196



ZAB

Racores baja presión 150 LBS

Screwed fittings low pressure 150 LBS
Raccords basse pression 150 LBS
Raccordi bassa pressione 150 LBS

■ **Racores baja presión 150 LBS / Screwed fittings low pressure 150 LBS / Adapteurs basse pression 150 LBS / Raccordi bassa pressione**

197

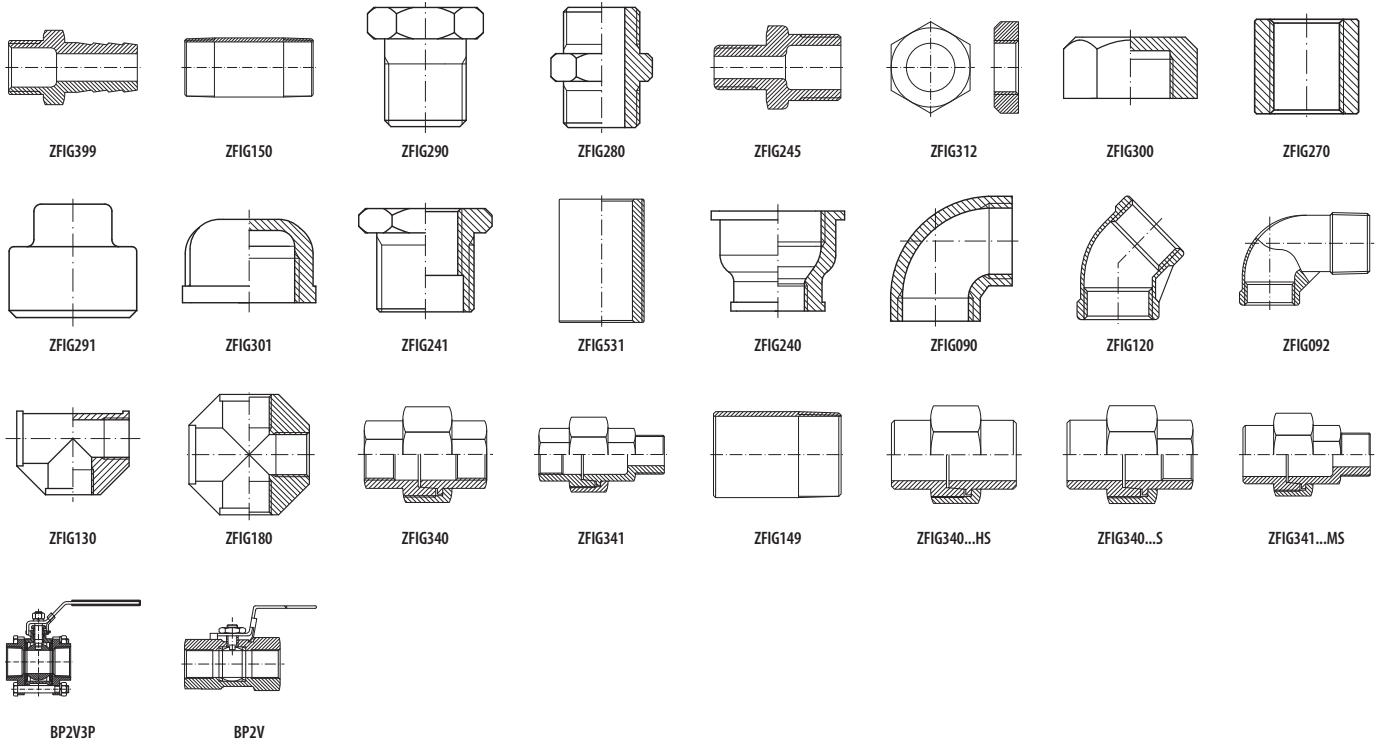

BP2V3P

BP2V

RACORES INDUSTRIALES

**NUEVOS
NEW**

INDUSTRIAL FITTINGS

● ● ● ●	CAMLOCK						
● ● ● ●	GUILLEMIN						
● ● ● ●	TW						
● ● ● ●	STORZ						
● ● ● ●	BARCELONA						
● ● ● ●	GEKA						
● ● ● ●	EXPRESS						
● ● ● ●	EA						
● ● ● ●	CHORRO ARENA SAND BLAST						

Consulte otros materiales en el catálogo de Conducciones. Request other materials in Catalogue Connectors

Bajo Consulta / On Request



ABRAZADERAS / CLAMPS



Tipo / Type
MORTERO/MORTAR

Tipo / Type
VICTAULIC

Tipo / Type
BAUER

Tipo / Type
PERROT

Tipo / Type
MILLER

Tipo / Type
CAMLOCK PP

Materiales Disponibles: ● Acero Carbono Carbon Steel ● Inox Stainless Steel ● Aluminio Aluminium ● Latón Brass

Industria alimentaria

Food industry
Raccords alimentaires
Raccordi alimentari

Casquillos para mangueras alimentarias

Food hoses ferrules

Jupes à sertir tuyaux alimentaires

Boccola a pressare per tubi alimentari

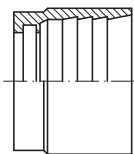

DN	Ø OUTER Ø EXT.	Part n° Referencia	€
13-1/2"	23	810421324	14,19
19-3/4"	32	810421933	18,39
25-1"	39	810422540	18,69
32-1"1/4	48	810423248	34,57
38-1"1/2	52	810423852	44,77
38-1"1/2	56	810423857	53,59
40-1"1/2	54	810424055	41,52
40-1"1/2	60	810424061	67,04
50-2"	63	810425064	54,26
50-2"	68	810425069	60,26
50-2"	73	810425073	69,03
65-2"1/2	79	810426580	74,94
65-2"1/2	93	810426593	142,60
70-3"	89	810427090	154,13
75-3"	94	810427595	125,51
75-3"	106	8104275107	182,30
100-4"	122	81042100123	225,88
100-4"	134	81042100135	266,92



Industria alimentaria

Food industry
Raccords alimentaires
Raccordi alimentari

Crimp fittings for hoses

Pipe fittings DIN 2353

Flare fittings JIC 37° / SAE Flanges

Adaptors

Welding fittings

Industrial fittings

Couplings, Ball valves and Hydraulic Components

Hembras giratorias SMS

Swivel female SMS

Raccord femelle tournante SMS

Femmina girevole SMS

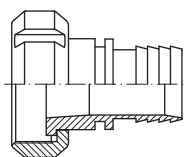

DN	THREAD ROSCA	Part n° Referencia	€
25	40x1/6	ZRA2004025	36,99
32	48x1/6	ZRA2004832	52,35
38	60x1/6	ZRA2006038	61,43
40	60x1/6	ZRA2006040	66,91
50	70x1/6	ZRA2007050	85,18
65	85x1/6	ZRA2008565	134,50
70	98x1/6	ZRA2009870	252,41
75	98x1/6	ZRA2009875	222,28
80	98x1/6	ZRA2009880	288,58
100	125x1/4	ZRA200125100	366,70
100	132x1/6	ZRA200132100	414,26

Machos fijos SMS

Fixed male SMS

Raccord mâle SMS

Maschio fisso SMS

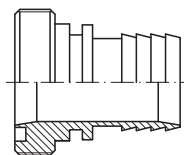

DN	THREAD ROSCA	Part n° Referencia	€
25	40x1/6	ZRA2124025	41,41
32	48x1/6	ZRA2124832	61,23
38	60x1/6	ZRA2126038	70,25
40	60x1/6	ZRA2126040	70,53
50	70x1/6	ZRA2127050	96,27
63	85x1/6	ZRA2128563	132,72
65	85x1/6	ZRA2128565	132,72
70	98x1/6	ZRA2129870	305,85
75	98x1/6	ZRA2129875	305,85
80	98x1/6	ZRA2129880	305,94
100	125x1/4	ZRA212125100	408,87
100	132x1/6	ZRA212132100	418,88

Tuercas SMS

Nuts SMS

Écrou SMS

Dadi SMS

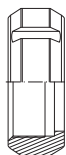

DN	THREAD ROSCA	Part n° Referencia	€
25	40x1/6	ZSMS H 25	10,61
32	48x1/6	ZSMS H 32	14,55
38	60x1/6	ZSMS H 38	20,16
51	70x1/6	ZSMS H 51	22,07
63	85x1/6	ZSMS H 63	27,47
76	98x1/6	ZSMS H 76	41,18
104	125x1/4	ZSMS H 104	50,94
104	132x1/6	ZSMS H 105	77,07

Cono soldable SMS

Liner to weld SMS

Douilles à souder SMS

Sede a saldare per femmina SMS



DN	Part n° Referencia	€
25	ZSMS S 25	3,58
32	ZSMS S 32	10,20
38	ZSMS S 38	6,39
51	ZSMS S 51	7,98
63	ZSMS S 63	11,00
76	ZSMS S 76	15,40
104	ZSMS S 104	19,73

Machos soldable SMS

Weld male SMS

Nez à souder SMS

Maschio a saldare SMS

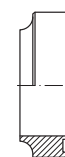

DN	THREAD ROSCA	Part n° Referencia	€
25	40x1/6	ZSMS M 25	6,12
32	48x1/6	ZSMS M 32	11,62
38	60x1/6	ZSMS M 38	14,23
51	70x1/6	ZSMS M 51	16,71
63	85x1/6	ZSMS M 63	25,03
76	98x1/6	ZSMS M 76	30,25
104	125x1/4	ZSMS M 104	40,56

Junta SMS silicona

Silicone joint for SMS

Joint silicone pour SMS

Guarnizione in silicone per SMS

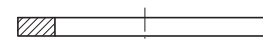

DN	Part n° Referencia	€
25	JSMSS 25	2,15
32	JSMSS 32	2,66
38	JSMSS 38	3,03
50/51	JSMSS 51	3,33
63/65	JSMSS 63	4,44
75/76	JSMSS 76	5,11
100/104	JSMSS 104	5,92

Juntas SMS PTFE

PTFE Joint for SMS

Joint PTFE pour SMS

Guarnizione in PTFE per SMS

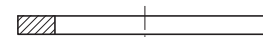

DN	Part n° Referencia	€
25	JSMSP 25	5,33
32	JSMSP 32	6,44
38	JSMSP 38	8,21
51	JSMSP 51	8,73
63	JSMSP 63	10,29
76	JSMSP 76	11,54

Industria alimentaria

Food industry
Raccords alimentaires
Raccordi alimentari

Tri-Clamp ISO 2852

Tri-Clamp ISO 2852

Raccord Tri-Clamp ISO 2852

Tri-Clamp ISO 2852 per tubo flessibile

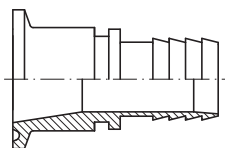

DN	Ø	Part n° Referencia	€
DN 12	25	ZTC2512	23,13
DN12	34	ZTC3412	34,56
DN19	34	ZTC3419	29,99
DN19	50	ZTC5019	37,73
DN25	50	ZTC5025	37,55
DN32	50	ZTC5032	40,65
DN38	50	ZTC5038	47,06
DN40	50	ZTC5040	48,89
DN38	64	ZTC6438	78,53
DN40	64	ZTC6440	60,97
DN50	64	ZTC6450	74,54
DN50	77	ZTC7750	106,29
DN65	91	ZTC9165	142,27

Tri-Clamp para soldar en tubo

Welding Tri-Clamp for pipe

Raccord Tri-Clamp à souder pour tube

Tri-Clamp a saldare per tubo rigido

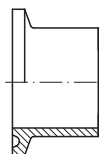

DN	Ø	Part n° Referencia	€
12	25	ZC25-12	6,47
12	34	ZC34-12	7,95
18	34	ZC34-18	7,48
18	50.5	ZC50-18	8,02
25	50.5	ZC50-25	7,48
33.7	50.5	ZC50-33.7	9,50
38	50.5	ZC50-38	8,76
38	64	ZC64-38	13,48
51	64	ZC64-51	11,45
65	91	ZC91-65	14,96

Junta para Clamp Silicona

Joint for silicone clamp

Joint pour clamp silicone

Guarnizione per clamp Silicone

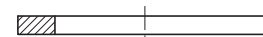

Ø	Part n° Referencia	€
25	JCLAMPS 25	3,54
34	JCLAMPS 34	3,89
50	JCLAMPS 50	3,05
64	JCLAMPS 64	5,34
77	JCLAMPS 77	6,66
91	JCLAMPS 91	9,37

Junta para Clamp PTFE

Joint for PTFE clamp

Joint pour clamp PTFE

Guarnizione per clamp PTFE



Ø	Part n° Referencia	€
25	JCLAMPP 25	*
34	JCLAMPP 34	*
50	JCLAMPP 50	9,19
64	JCLAMPP 64	10,82
77	JCLAMPP 77	12,42
91	JCLAMPP 91	18,38

Abrazadera Tri-clamp c/1 pin

Tri-Clamp with 1 pin

Collier Tri-Clamp avec 1 pin

Collare Tri-Clamp con 1 pin



Ø	Part n° Referencia	€
25	ZAC1P25	13,72
34	ZAC1P34	13,72
50	ZAC1P50	16,89
64	ZAC1P64	19,56
77	ZAC1P77	23,44
91	ZAC1P91	26,06

Industria alimentaria

Food industry
Raccords alimentaires
Raccordi alimentari

Crimp fittings for hoses

Pipe fittings DIN 2353

Flare fittings JIC 37° / SAE Flanges

Adaptors

Welding fittings

Industrial fittings

Couplings, Ball valves and Hydraulic Components

Hembra giratoria DIN 11851

Swivel female DIN 11851

Raccord femelle tournante DIN 11851

Femmina girevole DIN 11851

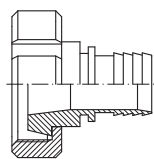

DN	THREAD ROSCA	Part n° Referencia	€
20	44x1/6	ZRA1004420	42,16
25	52x1/6	ZRA1005225	46,60
32	58x1/6	ZRA1005832	53,26
38	65x1/6	ZRA1006538	57,24
40	65x1/6	ZRA1006540	66,68
50	78x1/6	ZRA1007850	87,53
63	95x1/6	ZRA1009563	150,44
65	95x1/6	ZRA1009565	149,78
75	110x1/4	ZRA10011075	225,20
80	110x1/4	ZRA10011080	247,52
100	130x1/4	ZRA100130100	333,66

Macho fijo DIN 11851

Fixed male DIN 11851

Raccord mâle DIN 11851

Maschio fisso DIN 11851

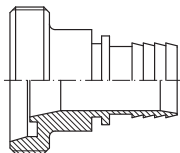

DN	THREAD ROSCA	Part n° Referencia	€
25	52x1/6	ZRA1125225	64,68
32	58x1/6	ZRA1125832	79,94
38	65x1/6	ZRA1126538	97,81
40	65x1/6	ZRA1126540	97,81
50	78x1/6	ZRA1127850	107,63
63	95x1/6	ZRA1129563	178,85
65	95x1/6	ZRA1129565	186,31
75	110x1/4	ZRA11211075	326,88
80	110x1/4	ZRA11211080	280,38
100	130x1/4	ZRA112130100	500,14

Tuercas DIN 11851

Nuts DIN 11851

Écrous DIN 11851

Dado DIN 11851



DN	THREAD ROSCA	Part n° Referencia	€
16	34x1/8	ZDIN H 16	8,25
20	44x1/6	ZDIN H 20	11,23
25	52x1/6	ZDIN H 25	13,54
32	58x1/6	ZDIN H 32	15,61
40	65x1/6	ZDIN H 40	18,08
50	78x1/6	ZDIN H 50	22,84
65	95x1/6	ZDIN H 65	37,87
80	110x1/4	ZDIN H 80	51,36
100	130x1/4	ZDIN H 100	70,95

Cono soldable DIN 11851

Liner to weld DIN 11851

Douilles à souder DIN 11851

Ogiva a saldare per dado DIN 11851



DN	Part n° Referencia	€
16	ZDIN S 16	3,09
20	ZDIN S 20	4,68
25	ZDIN S 25	6,60
32	ZDIN S 32	8,39
40	ZDIN S 40	8,93
50	ZDIN S 50	17,63
65	ZDIN S 65	21,79
75/80	ZDIN S 80	29,63
100	ZDIN S 100	47,37

Macho soldable DIN 11851

Weld male DIN 11851

Nez à souder DIN 11851

Maschio a saldare DIN 11851

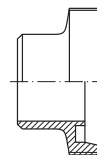

DN	THREAD ROSCA	Part n° Referencia	€
16	34x1/8	ZDIN M 16	4,95
20	44x1/6	ZDIN M 20	9,56
25	52x1/6	ZDIN M 25	9,56
32	58x1/6	ZDIN M 32	12,66
40	65x1/6	ZDIN M 40	15,84
50	78x1/6	ZDIN M 50	23,27
65	95x1/6	ZDIN M 65	31,97
75/80	110x1/4	ZDIN M 80	47,58
100	130x1/4	ZDIN M 100	62,56

Industria alimentaria

Food industry
Raccords alimentaires
Raccordi alimentari

Junta DIN 11851 silicona

Silicone joint for DIN 11851

Joint silicone pour DIN 11851

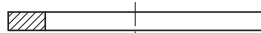

Guarnizione in silicone per DIN 11851

DN	Part n° Referencia	€
20	JDINS 20	1,18
25	JDINS 25	1,85
32	JDINS 32	2,15
38/40	JDINS 40	2,29
50	JDINS 50	2,96
65	JDINS 65	3,85
80	JDINS 80	4,96
100	JDINS 100	6,59

Junta DIN 11851 PTFE

PTFE Joint for DIN 11851

Joint PTFE pour DIN 11851

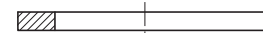

Guarnizione in PTFE per DIN 11851

DN	Part n° Referencia	€
20	JDINP 20	8,21
25	JDINP 25	8,81
32	JDINP 32	9,25
40	JDINP 40	10,06
50	JDINP 50	11,33
65	JDINP 65	12,51
80	JDINP 80	13,91
80	JDINP 100	*

Hembra giratoria Macon

Swivel female Macon

Raccord femelle tournante Macon

Femmina girevole Macon

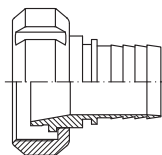

DN	THREAD ROSCA	Part n° Referencia	€
38	55X3	ZRA3005538	83,34
40	55X3	ZRA3005540	86,54
50	67X3	ZRA3006750	93,54
65	79X3.5	ZRA3007965	87,48
65	90X3.5	ZRA3009065	102,30
70	90X3.5	ZRA3009070	102,30
80	90X3.5	ZRA3009080	103,23
80	102x4	ZRA30010280	130,49
100	125X4	ZRA300125100	361,15

Macho fijo Macon

Male fixe Macon

Raccord mâle fixe Macon

Maschio fisso Macon

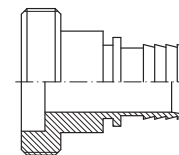

DN	THREAD ROSCA	Part n° Referencia	€
38	55X3	ZRA3125538	80,81
40	55X3	ZRA3125540	74,74
50	67X3	ZRA3126750	105,64
65	79X3.5	ZRA3127965	158,00
65	90X3.5	ZRA3129065	194,12
70	90X3.5	ZRA3129070	174,71
75	90X3.5	ZRA3129080	174,71
80	102X4	ZRA31210280	253,94
100	125X4	ZRA312125100	389,37

Tuercas Macon

Macon nuts

Écrous à crans Macon

Dadi Macon



DN	THREAD ROSCA	Part n° Referencia	€
40	55X3	ZMAC H 40	19,25
50	67X3	ZMAC H 50	21,38
60	79X3.5	ZMAC H 60	31,99
70	90X3.5	ZMAC H 70	36,21
80	102X4	ZMAC H 80	40,01
100	125X4	ZMAC H 100	47,16

Industria alimentaria

Food industry
Raccords alimentaires
Raccordi alimentari

Crimp fittings for hoses

Pipe fittings DIN 2353

Flare fittings JIC 37° / SAE Flanges

Adaptors

Welding fittings

Industrial fittings

Couplings, Ball valves and Hydraulic Components

Hembra giratoria prensar SMS para PTFE Serie STD

Swivel female SMS for PTFE STD Series

Femelle tournante SMS pour PTFE Série STD

Femmina girevole SMS per tubo PTFE Serie STD

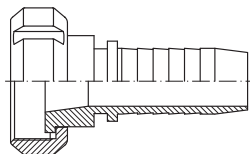

DN	THREAD ROSCA	Part nº Referencia	€
1"	40x1/6"	ZRA2504016	58,03
1" 1/4	48x1/6"	ZRA2504820	61,99
1" 1/2	60x1/6"	ZRA2506024	80,69
2"	70x1/6"	ZRA2507032	97,60
2" 1/2	85x1/6"	ZRA2508540	173,22

Hembra giratoria DIN 11851 para PTFE Serie STD

Swivel female DIN 11851 for PTFE hose STD Series

Raccord femelle tournante DIN 11851 pour PTFE Série STD

Femmina girevole DIN 11851 per tubo PTFE Serie STD

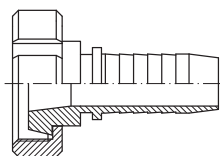

DN	THREAD ROSCA	Part nº Referencia	€
1"	52x1/6"	ZRA1505216	58,83
1" 1/4	58x1/6"	ZRA1505820	68,28
1" 1/2	65x1/6"	ZRA1506524	84,70
2"	78x1/6"	ZRA1507832	110,07
2" 1/2	95x1/6"	ZRA1509540	191,79

Casquillos PTFE corrugado

Ferrules for convoluted PTFE

Jupes PTFE convoluté

Boccola pressare per PTFE corrugato

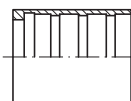

DN	Part nº Referencia	€
1/4"	810410400	*
5/16"	810410500	*
3/8"	810410600	*
1/2"	810410800	*
5/8"	810411000	*
3/4"	810411201	*
1"	810411600	*
1"1/4	810412000	*
1"1/2	810412400	*
2"	810413200	*
2"1/2	810414000	*

*Ver precios en p.22 / *See prices p.22 / *Voir prix p.22

Machos SMS para PTFE Serie STD

Fixed male SMS for PTFE hose STD Series

Raccord mâle SMS pour PTFE Série STD

Maschio SMS per tubo PTFE Serie STD

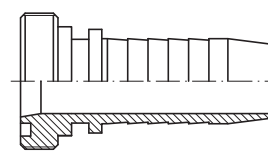

DN	THREAD ROSCA	Part nº Referencia	€
1"	40x1/6"	ZRA2524016	45,55
1" 1/4	48x1/6"	ZRA2524820	67,35
1" 1/2	60x1/6"	ZRA2526024	84,60
2"	70x1/6"	ZRA2527032	108,17
2" 1/2	85x1/6"	ZRA2528540	175,37

Machos DIN 11851 para PTFE Serie STD

Fixed male DIN 11851 for PTFE hose STD Series

Raccord mâle DIN 11851 pour PTFE Série STD

Maschio DIN 11851 per tubo PTFE Serie STD

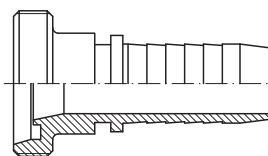

DN	THREAD ROSCA	Part nº Referencia	€
1"	52x1/6"	ZRA1525216	79,55
1" 1/4	58x1/6"	ZRA1525820	87,93
1" 1/2	65x1/6"	ZRA1526524	107,59
2"	78x1/6"	ZRA1527832	161,79
2" 1/2	95x1/6"	ZRA1529540	261,04

Casquillos PTFE liso

Ferrules for smooth PTFE

Jupes PTFE lisse

Boccole pressare per PTFE liscio

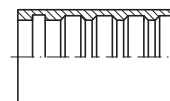

DN	Part nº Referencia	€
3/16"	810400300	*
1/4"	810400400	*
5/16"	810400500	*
3/8"	810400600	*
1/2"	810400800	*
5/8"	810401000	*
3/4"	810401200	*
7/8"	810401400	*
1"	810401600	*
1"1/8	810401800	*

*Ver precios en p.22 / *See prices p.22 / *Voir prix p.22

Industria alimentaria

Food industry
Raccords alimentaires
Raccordi alimentari

Hembra giratoria prensar SMS para PTFE corrugado

Swivel female SMS for convoluted PTFE

Femelle tournante SMS pour PTFE convoluté

Femmina girevole a pressare SMS per tubo corrugato PTFE

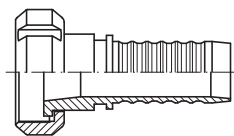

DN	THREAD ROSCA	Part n° Referencia	€
1"	40x1/6	ZRA5004016	82,20
1" 1/4	48x1/6	ZRA5004820	85,68
1" 1/2	60x1/6	ZRA5006024	102,14
2"	70x1/6	ZRA5007032	127,37

Hasta fin de existencias / Until end of stock / Jusqu'à la fin du stock / Fino ad esaurimento scorta

Machos SMS para PTFE corrugado

Fixed male SMS for convoluted PTFE hose

Raccord mâle SMS PTFE convoluté

Maschio fisso SMS per tubo corrugato PTFE

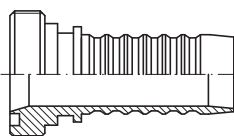

DN	THREAD ROSCA	Part n° Referencia	€
1"	40x1/6	ZRA5124016	64,11
1" 1/4	48x1/6	ZRA5124820	86,06
1" 1/2	60x1/6	ZRA5126024	108,11
2"	70x1/6	ZRA5127032	149,11

Hasta fin de existencias / Until end of stock / Jusqu'à la fin du stock / Fino ad esaurimento scorta

Hembra giratoria DIN 11851 para PTFE corrugado

Swivel female DIN 11851 for convoluted PTFE hose

Raccord femelle tournante DIN 11851 PTFE convoluté

Femmina girevole DIN 11851 per tubo corrugato PTFE

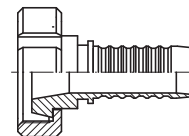

DN	THREAD ROSCA	Part n° Referencia	€
1" 1/4	58x1/6	ZRA4005820	100,96

Hasta fin de existencias / Until end of stock / Jusqu'à la fin du stock / Fino ad esaurimento scorta

Machos DIN 11851 para PTFE corrugado

Fixed male DIN 11851 for convoluted PTFE hose

Raccord mâle DIN 11851 PTFE convoluté

Maschio fisso DIN 11851 per tubo corrugato PTFE

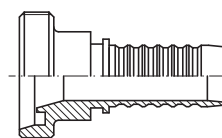

DN	THREAD ROSCA	Part n° Referencia	€
1"	52x1/6	ZRA4125216	101,64
1" 1/4	58x1/6	ZRA4125820	112,36
1" 1/2	65x1/6	ZRA4126524	137,48

Hasta fin de existencias / Until end of stock / Jusqu'à la fin du stock / Fino ad esaurimento scorta

Casquillos PTFE corrugado para racores alimentarios

Convoluted PTFE ferrules for food fittings

Jupes PTFE convoluté pour raccords alimentaires

Boccola a pressare Teflon corrugato per raccordi alimentari

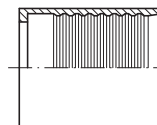

DN	Part n° Referencia	€
1"	810501600	32,81
1" 1/4	810502000	47,32
1" 1/2	810502400	62,97
2"	810503200	82,15

Hasta fin de existencias / Until end of stock / Jusqu'à la fin du stock / Fino ad esaurimento scorta

Camlock

Camlock Fittings
Raccords Camlock
Camlock

Crimp fittings for hoses

Pipe fittings DIN 2353

Flare fittings JIC 37° / SAE Flanges

Adaptors

Welding fittings

Industrial fittings

Couplings, Ball valves and Hydraulic Components

Camlock macho - rosca hembra BSP Tipo A

Adaptor, female BSP threaded Type A

Adapteur mâle - filetage femelle BSP Type A

Adattatore maschio-filettatura femmina Tipo A

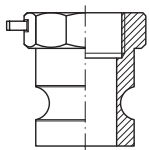

DN	THREAD ROSCA	Part n° Referencia	€
12	1/2"	ZA012	6,28
20	1/2"	ZA015	6,28
20	3/4"	ZA020	8,61
25	1"	ZA025	11,34
32	1"1/4	ZA032	15,88
40	1"1/2	ZA040	21,65
50	2"	ZA050	25,79
65	2"1/2	ZA065	41,04
80	3"	ZA080	52,25
100	4"	ZA100	72,62

Camlock hembra - rosca macho BSP Tipo B

Coupling, female BSP threaded Type B

Adapteur femelle - filetage mâle BSP Type B

Adattatore femmina-filettatura maschio Tipo B

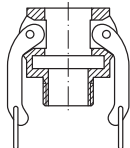

DN	THREAD ROSCA	Part n° Referencia	€
12	1/2"	ZB012	14,45
20	1/2"	ZB015	13,15
20	3/4"	ZB020	14,52
25	1"	ZB025	19,50
32	1"1/4	ZB032	27,59
40	1 1/2"	ZB040	29,25
50	2"	ZB050	39,51
65	2"1/2	ZB065	51,14
80	3"	ZB080	72,23
100	4"	ZB100	101,85

Camlock hembra - para manguera Tipo C

Coupling with serrated hose shank Type C

Coupleur femelle - pour tuyau Type C

Adattatore con inserto per tubo Tipo C

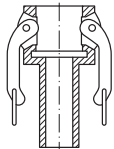

DN	Part n° Referencia	€
1/2"	ZC012	12,14
1/2"	ZC015	13,44
3/4"	ZC020	15,17
1"	ZC025	19,76
1"1/4	ZC032	25,95
1"1/2	ZC040	28,68
2"	ZC050	36,41
2"1/2	ZC065	54,05
3"	ZC080	88,67
4"	ZC100	113,33

Camlock hembra - rosca hembra BSP Tipo D

Coupling, female threaded Type D

Adapteur femelle Type D

Adattatore femmina Tipo D

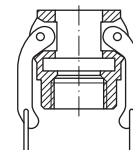

DN	THREAD ROSCA	Part n° Referencia	€
12	1/2"	ZD012	12,71
20	1/2"	ZD015	14,01
20	3/4"	ZD020	14,37
25	1"	ZD025	19,76
32	1"1/4	ZD032	30,06
40	1"1/2	ZD040	29,61
50	2"	ZD050	41,36
65	2"1/2	ZD065	51,66
80	3"	ZD080	66,10
100	4"	ZD100	105,75

Camlock macho - para manguera Tipo E

Adaptor, with serrated hose shank Type E

Coupleur mâle Type E

Adattatore con inserto per Tipo E

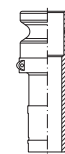

DN	Part n° Referencia	€
1/2"	ZE012	6,46
1/2"	ZE015	6,46
3/4"	ZE020	8,81
1"	ZE025	13,20
1"1/4	ZE032	17,38
1"1/2	ZE040	25,14
2"	ZE050	32,37
2"1/2	ZE065	43,94
3"	ZE080	79,87
4"	ZE100	105,86

Camlock macho - rosca macho BSP Tipo F

Adaptor, male threaded Type F

Adapteur mâle Type F

Adattatore maschio Tipo F

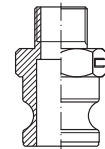

DN	THREAD ROSCA	Part n° Referencia	€
12	1/2"	ZF012	7,39
20	1/2"	ZF015	7,39
20	3/4"	ZF020	9,09
25	1"	ZF025	12,69
32	1"1/4	ZF032	17,15
40	1"1/2	ZF040	26,54
50	2"	ZF050	30,86
65	2"1/2	ZF065	48,51
80	3"	ZF080	61,81
100	4"	ZF100	97,70

Camlock

Camlock Fittings
Raccords Camlock
Camlock

Camlock hembra - tapón Tipo DC

Dust caps Type DC

Bouchon femelle Type DC

Tappo di protezione Tipo DC

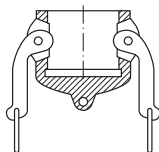

DN	Part n° Referencia	€
12	ZDC012	11,85
20	ZDC020	14,61
25	ZDC025	18,42
32	ZDC032	26,73
40	ZDC040	27,14
50	ZDC050	35,11
65	ZDC065	43,84
80	ZDC080	60,11
100	ZDC100	81,41

Camlock macho - tapón tipo DP

Dust plugs Type DP

Bouchon mâle Type DP

Cappuccio di protezione Tipo DP

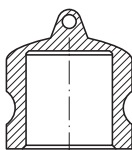

DN	Part n° Referencia	€
12	ZDP012	5,54
20	ZDP020	6,77
25	ZDP025	9,03
32	ZDP032	13,44
40	ZDP040	15,42
50	ZDP050	22,06
65	ZDP065	36,93
80	ZDP080	45,14
100	ZDP100	70,68

Junta Camlock NBR

Camlock NBR Seal

Joint Camlock NBR

Guarnizione in NBR per Camlock

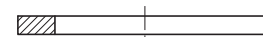

DN	Part n° Referencia	€
12	JCAMNBR012	0,85
20	JCAMNBR020	0,85
25	JCAMNBR025	1,48
32	JCAMNBR032	1,70
40	JCAMNBR040	1,91
50	JCAMNBR050	3,07
65	JCAMNBR065	3,82
80	JCAMNBR080	3,50
100	JCAMNBR100	4,13

Junta Camlock silicona

Camlock silicone seal

Joint Camlock silicone

Guarnizione in silicone per Camlock

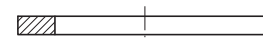

DN	Part n° Referencia	€
12	JCAMS012	2,18
20	JCAMS020	2,18
25	JCAMS025	2,67
32	JCAMS032	4,28
40	JCAMS040	5,74
50	JCAMS050	6,47
65	JCAMS065	7,20
80	JCAMS080	10,75
100	JCAMS100	14,39

Acoples GUILLEMIN NF E-29572

GUILLEMIN NF E-29572 Fittings
Raccords GUILLEMIN NF E-29572
Raccordi GUILLEMIN NF E-29572

Crimp fittings for hoses

Pipe fittings DIN 2353

Flare fittings JIC 37° / SAE Flanges

Adaptors

Welding fittings

Industrial fittings

Couplings, Ball valves and Hydraulic Components

Rosca hembra BSP con cierre

BSP Female thread with closure

Filetage Femelle BSP avec fermeture

Filetto femmina BSP con chiusura



DN	THREAD ROSCA	Part n° Referencia	€
20	3/4"	ZGU01C020	27,00
25	1"	ZGU01C025	27,00
32	1" 1/4	ZGU01C032	38,83
40	1" 1/2	ZGU01C040	52,28
50	2"	ZGU01C050	89,72
65	2" 1/2	ZGU01C065	133,67
80	3"	ZGU01C080	135,72
100	4"	ZGU01C100	281,56

Rosca hembra BSP sin cierre

BSP Female thread without closure

Filetage Femelle BSP sans fermeture

Filetto femmina BSP senza chiusura



DN	THREAD ROSCA	Part n° Referencia	€
20	3/4"	ZGU01S020	19,78
25	1"	ZGU01S025	19,78
32	1" 1/4	ZGU01S032	19,78
40	1" 1/2	ZGU01S040	30,11
50	2"	ZGU01S050	33,72
65	2" 1/2	ZGU01S065	46,44
80	3"	ZGU01S080	76,17
100	4"	ZGU01S100	88,39

Rosca macho BSP con cierre

BSP Male thread with closure

Filetage Mâle BSP avec fermeture

Filetto maschio BSP con chiusura



DN	THREAD ROSCA	Part n° Referencia	€
20	3/4"	ZGU02C020	24,06
25	1"	ZGU02C025	24,06
32	1" 1/4	ZGU02C032	33,44
40	1" 1/2	ZGU02C040	34,28
50	2"	ZGU02C050	63,28
65	2" 1/2	ZGU02C065	81,72
80	3"	ZGU02C080	125,22
100	4"	ZGU02C100	191,72

Rosca macho BSP sin cierre

BSP Male thread without closure

Filetage Mâle BSP sans fermeture

Filetto maschio BSP senza chiusura



DN	THREAD ROSCA	Part n° Referencia	€
20	3/4"	ZGU02S020	17,17
25	1"	ZGU02S025	19,78
32	1" 1/4	ZGU02S032	19,78
40	1" 1/2	ZGU02S040	20,56
50	2"	ZGU02S050	34,89
65	2" 1/2	ZGU02S065	49,33
80	3"	ZGU02S080	76,50
100	4"	ZGU02S100	135,28

Tapón con cierre

Plug with closure

Bouchon avec fermeture

Tappo con chiusura



DN	Part n° Referencia	€
20	ZGU04C020	22,06
25	ZGU04C025	22,06
32	ZGU04C032	23,83
40	ZGU04C040	31,11
50	ZGU04C050	46,56
65	ZGU04C065	60,72
80	ZGU04C080	97,28
100	ZGU04C100	144,72

Tapón sin cierre

Plug without closure

Bouchon sans fermeture

Tappo senza chiusura



DN	Part n° Referencia	€
20	ZGU04S020	*
25	ZGU04S025	*
32	ZGU04S032	*
40	ZGU04S040	*
50	ZGU04S050	*
65	ZGU04S065	*
80	ZGU04S080	*
100	ZGU04S100	*

Acoples GUILLEMIN NF E-29572

GUILLEMIN NF E-29572 Fittings
Raccords GUILLEMIN NF E-29572
Raccordi GUILLEMIN NF E-29572

Crimp fittings for hoses

Pipe fittings DIN 2353

Flare fittings JIC37° / SAE Flanges

Adaptors

Welding fittings

Industrial fittings

Couplings, Ball valves and Hydraulic Components

Reductor con cierre

Reducer with closure

Réduction avec fermeture

Riduzione con chiusura



DN	Part n° Referencia	€
40-32	ZGU03C040032	*
50-32	ZGU03C050040	*
65-50	ZGU03C065050	*
80-65	ZGU03C080065	*
100-80	ZGU03C100080	*

Para manguera con cierre

For hose with closure

Pour tuyau avec fermeture

Per tubo con chiusura



DN	THREAD ROSCA	Part n° Referencia	€
40	1" 1/2	ZGU05C040040	34,78
50	2"	ZGU05C050050	69,44
65	2" 1/2	ZGU05C065065	87,89
80	3"	ZGU05C080080	144,72

Soldable con cierre

Welding with closure

À souder avec fermeture

Saldabile con chiusura



DN	THREAD ROSCA	Part n° Referencia	€
40	1"1/2	ZGU06C040040	*
50	2"	ZGU06C050050	*
65	2" 1/2	ZGU06C065065	*
80	3"	ZGU06C080080	*

Acoples TW DIN 28450

TW DIN 28450 Fittings
Raccords TW DIN 28450
Raccordi TW DIN 28450

Crimp fittings for hoses

Pipe fittings DIN 2353

Flare fittings JIC 37° / SAE Flanges

Adaptors

Welding fittings

Industrial fittings

Couplings, Ball valves and Hydraulic Components

Rosca hembra BSP - acople hembra

BSP Female thread - female coupling

Filetage Femelle BSP - accouplement Femelle

Filetto femmina BSP - accoppiamento femmina



DN	Part nº Referencia	€
2"	ZMK05032	66,67
3"	ZMK08048	121,44
4"	ZMK10064	237,11

Rosca hembra BSP - acople macho

BSP Female thread - male coupling

Filetage Femelle BSP - accouplement Mâle

Filetto femmina BSP - accoppiamento maschio



DN	Part nº Referencia	€
2"	ZVK05032	32,44
3"	ZVK08048	63,50
4"	ZVK10064	89,17

Tapón - acople hembra

Plug - female coupling

Bouchon - accouplement Femelle

Tappo - accoppiamento femmina



DN	Part nº Referencia	€
2"	ZMB050	28,61
3"	ZMB080	57,39
4"	ZMB100	97,39

Tapón - acople macho

Plug - male coupling

Bouchon - accouplement Mâle

Tappo - accoppiamento maschio



DN	Part nº Referencia	€
2"	ZVB050	25,94
3"	ZVB080	46,22
4"	ZVB100	73,44

Soldable - acople hembra

Welding - female coupling

À souder - accouplement Femelle

Saldabile - accoppiamento femmina



DN	Part nº Referencia	€
2"	ZMKS050050	*
3"	ZMKS080080	*
4"	ZMKS100100	*

Soldable - acople macho

Welding - male coupling

À souder - accouplement Mâle

Saldabile - accoppiamento maschio



DN	Part nº Referencia	€
2"	ZVKS050050	*
3"	ZVKS080080	*
4"	ZVKS100100	*

Accesorios inox para racor industrial

Stainless Steel accessories for industrial fitting
Accessoires acier inox pour raccord industriel
Accessorio in acciaio inossidabile per raccordo industriale

Campana inox para racor industrial - cierre 45°

Stainless Steel Crimping Ferrule 45° closure

Jupe pour raccord industriel acier inox
-fermeture 45°

Boccola in acciaio inossidabile per raccordo industriale-chiusura 45°



DN	Part n° Referencia	€
25	ZCA025	6,17
32	ZCA032	8,67
40	ZCA040	9,00
50	ZCA050	13,89
50	ZCA05001	28,33
65	ZCA065	29,44
80	ZCA080	24,83
100	ZCA100	66,67

Abrazadera EN 14420-3 inox para racor industrial

Stainless Steel clamp for industrial fitting EN14420-3

Collier pour raccord industriel acier inox EN 14420-3

Collare EN 14420 in acciaio inossidabile per raccordo industriale



Ø INNER Ø INT.	Part n° Referencia	€
34-37	ZAB01034037	*
36-39	ZAB01036039	*
41-44	ZAB01041044	*
47-51	ZAB01047051	*
60-64	ZAB01060064	*
63-67	ZAB01063067	*
74-77	ZAB01074077	*
84-87	ZAB01084087	*
87-90	ZAB01087090	*
89-94	ZAB01089094	*
114-119	ZAB01114119	*

Racores baja presión 150 LBS

Screwed fittings low pressure 150 LBS

Raccords basse pression 150 LBS

Raccordi bassa pressione 150 LBS

Macho fijo espiga FIG.399

Nipple fixed male fig.399

Mâle fixe nipple fig. 399 inox

Nipples m-m fisso fig. 399 inox

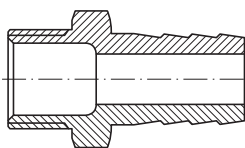

DN	THREAD ROSCA	Part nº Referencia	€
10	1/4"	ZFIG39904	2,49
12	3/8"	ZFIG39906	3,10
15	1/2"	ZFIG39908	3,71
20	3/4"	ZFIG39912	6,40
25	1"	ZFIG39916	8,13
32	1" 1/4	ZFIG39920	12,71
40	1" 1/2	ZFIG39924	16,51
52	2"	ZFIG39932	26,55

Unión macho-macho FIG.150

Union male-male fig.150

Union mâle-mâle fig.150 inox

Unione maschio-maschio fig.150 inox



THREAD ROSCA	Part nº Referencia	€
1/4"	ZFIG15004	1,82
3/8"	ZFIG15006	2,09
1/2"	ZFIG15008	3,23
3/4"	ZFIG15012	4,25
1"	ZFIG15016	5,40
1" 1/4	ZFIG15020	9,30
1" 1/2	ZFIG15024	10,36
2"	ZFIG15032	17,32

Tapón macho hexagonal FIG.290

Hexagon male plug FIG.290

Bouchon mâle 150 LBS tête hexagonale FIG.290

Tappo maschio esagonale FIG.290

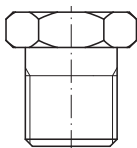

THREAD ROSCA	Part nº Referencia	€
1/8"	ZFIG29002	1,66
1/4"	ZFIG29004	1,68
3/8"	ZFIG29006	1,95
1/2"	ZFIG29008	2,63
3/4"	ZFIG29012	3,98
1"	ZFIG29016	5,32
1"1/4	ZFIG29020	8,09
1"1/2	ZFIG29024	10,47
2"	ZFIG29032	15,43
2"1/2	ZFIG29040	26,29
3"	ZFIG29048	38,27
4"	ZFIG29060	62,77

Adaptador hexagonal FIG.280

Hexagon nipple FIG.280

Mamelon hexagonal 150 LBS FIG.280

Nipples esagonale FIG.280

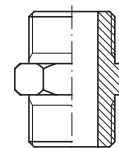

THREAD ROSCA	Part nº Referencia	€
1/4"	ZFIG28004	2,02
3/8"	ZFIG28006	2,53
1/2"	ZFIG28008	3,64
3/4"	ZFIG28012	5,12
1"	ZFIG28016	7,55
1"1/4	ZFIG28020	9,37
1"1/2	ZFIG28024	12,94
2"	ZFIG28032	22,10
2"1/2	ZFIG28040	37,26
3"	ZFIG28048	49,79
4"	ZFIG28060	71,01

Reducción macho-macho FIG.245

Reducer male-male fig. 245

Réduction mâle-mâle fig. 245 inox

Riduzione maschio-maschio fig. 245 inox

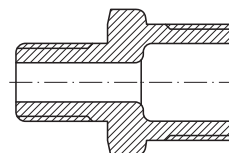

THREAD ROSCA	Part nº Referencia	€
1/4"	ZFIG2450402	1,75
3/8"	ZFIG2450604	2,22
1/2"	ZFIG2450804	3,17
1/2"	ZFIG2450806	2,83
3/4"	ZFIG2451206	3,84
3/4"	ZFIG2451208	4,45
1"	ZFIG2451608	6,40
1"	ZFIG2451612	5,79
1" 1/4	ZFIG2452012	7,48
1" 1/4	ZFIG2452016	9,23
1" 1/2	ZFIG2452416	10,71
1" 1/2	ZFIG2452420	10,71
2"	ZFIG2453220	14,55
2"	ZFIG2453224	16,57
2" 1/2	ZFIG2454032	28,63
3"	ZFIG2454840	47,30

Tuerca plana FIG.312

Flat nut fig.312

Écrou plat fig.312 inox

Dado piano fig.312 inox

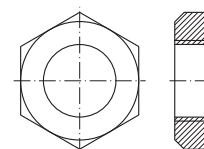

THREAD ROSCA	Part nº Referencia	€
1/4"	ZFIG31204	1,48
3/8"	ZFIG31206	1,62
1/2"	ZFIG31208	1,68
3/4"	ZFIG31212	2,29
1"	ZFIG31216	2,90
1" 1/4	ZFIG31220	4,04
1" 1/2	ZFIG31224	5,39
2"	ZFIG31232	8,22

Racores baja presión 150 LBS

Screwed fittings low pressure 150 LBS

Raccords basse pression 150 LBS

Raccordi bassa pressione 150 LBS

Crimp fittings for hoses

Pipe fittings DIN 2353

Flare fittings JIC37° / SAE Flanges

Adaptors

Welding fittings

Industrial fittings

Couplings, Ball valves and Hydraulic Components

Tapón hembra hexagonal FIG.300

Hexagon female cap FIG.300

Bouchon femelle hexagonal 150 LBS FIG.300

Tappo femmina esagonale FIG.300

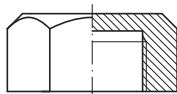

THREAD ROSCA	Part nº Referencia	€
1/8"	ZFIG30002	1,95
1/4"	ZFIG30004	2,09
3/8"	ZFIG30006	2,09
1/2"	ZFIG30008	3,30
3/4"	ZFIG30012	3,81
1"	ZFIG30016	6,21
1"1/4	ZFIG30020	8,56
1"1/2	ZFIG30024	9,72
2"	ZFIG30032	15,29
2"1/2	ZFIG30040	25,79
3"	ZFIG30048	37,71
4"	ZFIG30060	67,71

Adaptador hembra BSP DIN 2986 FIG.270

BSP Female coupling DIN 2986 FIG.270

Manchon femelle gaz DIN 2986 150 LBS FIG.270

Adattatore femmina BSP DIN 2986 FIG.270

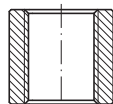

THREAD ROSCA	Part nº Referencia	€
1/4"	ZFIG27004	2,85
3/8"	ZFIG27006	2,96
1/2"	ZFIG27008	4,51
3/4"	ZFIG27012	5,53
1"	ZFIG27016	7,94
1"1/4	ZFIG27020	11,72
1"1/2	ZFIG27024	13,95
2"	ZFIG27032	19,54
2"1/2	ZFIG27040	32,81
3"	ZFIG27048	43,19
4"	ZFIG27060	72,77

Tapón macho cuadrado FIG.291

Male square plug FIG.291

Bouchon mâle 150 LBS tête carrée FIG.291

Tappo maschio testa quadrata FIG.291

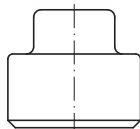

THREAD ROSCA	Part nº Referencia	€
1/8"	ZFIG29102	1,73
1/4"	ZFIG29104	1,68
3/8"	ZFIG29106	1,95
1/2"	ZFIG29108	2,24
3/4"	ZFIG29112	3,30
1"	ZFIG29116	4,45
1"1/4	ZFIG29120	6,79
1"1/2	ZFIG29124	8,45
2"	ZFIG29132	13,58
2"1/2	ZFIG29140	18,71
3"	ZFIG29148	28,75
4"	ZFIG29160	46,08

Tapón hembra redondo FIG.301

Round female cap FIG.301

Bouchon femelle ronde 150 LBS FIG.301

Tappo femmina rotondo FIG.301

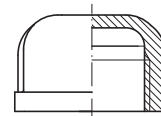

THREAD ROSCA	Part nº Referencia	€
1/8"	ZFIG30102	2,02
1/4"	ZFIG30104	2,02
3/8"	ZFIG30106	2,08
1/2"	ZFIG30108	3,29
3/4"	ZFIG30112	4,77
1"	ZFIG30116	5,92
1"1/4	ZFIG30120	9,75
1"1/2	ZFIG30124	10,49
2"	ZFIG30132	13,24
2"1/2	ZFIG30140	22,91
3"	ZFIG30148	32,27
4"	ZFIG30160	56,19

Hasta fin de existencias / Until end of stock / Jusqu'à la fin du stock / Fino ad esaurimento scorta

Reductor macho-hembra FIG.241

Male-female reducer FIG.241

Réduction 150 LBS MG - FG FIG.241

Riduzione maschio-femmina FIG.241

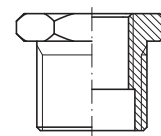

THREAD ROSCA	Part nº Referencia	€	
1/8"	1/4"	ZFIG2410204	2,02
1/4"	3/8"	ZFIG2410406	2,09
1/4"	1/2"	ZFIG2410408	2,82
3/8"	1/2"	ZFIG2410608	2,75
1/2"	3/4"	ZFIG2410812	3,97
3/4"	1"	ZFIG2411216	5,59
1"	1"1/4	ZFIG2411620	8,28
1"1/4	1"1/2	ZFIG2412024	9,61
1"1/2	2"	ZFIG2412432	16,97
2"	2"1/2	ZFIG2413240	25,98
2"1/2	3"	ZFIG2414048	39,22
3"	4"	ZFIG2414860	65,89

Tubo roscado FIG.531

Threaded pipe fig. 531

Tube fileté fig. 531 inox

Tubo filettato fig. 531 inox



THREAD ROSCA	Part nº Referencia	€
1/4"	ZFIG53104	2,49
3/8"	ZFIG53106	2,76
1/2"	ZFIG53108	3,10
3/4"	ZFIG53112	3,64
1"	ZFIG53116	4,99
1" 1/4	ZFIG53120	6,94
1" 1/2	ZFIG53124	8,02
2"	ZFIG53132	10,92

Racores baja presión 150 LBS

Screwed fittings low pressure 150 LBS

Raccords basse pression 150 LBS

Raccordi bassa pressione 150 LBS

Reducción hembra-hembra FIG.240

Reducer socket FIG.240

Réduction 150 LBS FIG.240

Riduzione femmina-femmina FIG.240

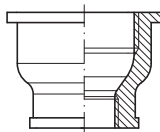

THREAD ROSCA		Part nº Referencia	€
1/4"	1/8"	ZFIG2400402	2,09
3/8"	1/4"	ZFIG2400604	2,75
1/2"	3/8"	ZFIG2400806	3,83
3/4"	1/2"	ZFIG2401208	5,05
1"	3/4"	ZFIG2401612	7,51
1"1/4"	1"	ZFIG2402016	10,76
1"1/2"	1"1/4"	ZFIG2402420	14,52
2"	1"1/2"	ZFIG2403224	19,94
2"1/2"	2"	ZFIG2404032	31,13
3"	2"	ZFIG2404832	46,95
3"	2"1/2"	ZFIG2404840	50,56
4"	2"	ZFIG2406032	71,58

Codo 90° hembra-hembra FIG.090

Female-female elbow 90° FIG.090

Coude 90° 150 LBS femelle gaz FIG.090

Curva 90° femmina-femmina FIG.090

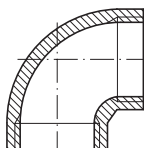

THREAD ROSCA	Part nº Referencia	€
1/8"	ZFIG09002	1,95
1/4"	ZFIG09004	2,22
3/8"	ZFIG09006	2,60
1/2"	ZFIG09008	3,83
3/4"	ZFIG09012	5,59
1"	ZFIG09016	8,29
1"1/4"	ZFIG09020	11,56
1"1/2"	ZFIG09024	16,24
2"	ZFIG09032	24,93
2"1/2"	ZFIG09040	52,08
3"	ZFIG09048	74,11
4"	ZFIG09060	133,54

Codo 45° hembra-hembra FIG.120

Female-female elbow 45° FIG.120

Coude 45° 150 LBS FG - FG FIG.120

Adattatore a 45° femmina-femmina

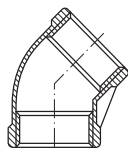

THREAD ROSCA	Part nº Referencia	€
1/8"	ZFIG12002	2,67
1/4"	ZFIG12004	3,03
3/8"	ZFIG12006	3,61
1/2"	ZFIG12008	4,43
3/4"	ZFIG12012	6,53
1"	ZFIG12016	8,81
1"1/4"	ZFIG12020	13,81
1"1/2"	ZFIG12024	16,91
2"	ZFIG12032	26,14
2"1/2"	ZFIG12040	54,82
3"	ZFIG12048	78,59
4"	ZFIG12060	128,89

Codo 90° macho-hembra FIG.092

Male-female elbow 90° FIG.092

Coude 90° 150 LBS MG - FG FIG.092

Adattatore a 90° maschio-femmina FIG.092

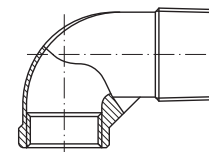

THREAD ROSCA	Part nº Referencia	€
1/8"	ZFIG09202	2,75
1/4"	ZFIG09204	3,30
3/8"	ZFIG09206	3,64
1/2"	ZFIG09208	4,31
3/4"	ZFIG09212	6,27
1"	ZFIG09216	9,23
1"1/4"	ZFIG09220	13,65
1"1/2"	ZFIG09224	17,99
2"	ZFIG09232	25,47
2"1/2"	ZFIG09240	51,21
3"	ZFIG09248	84,42
4"	ZFIG09260	161,03

TE hembra-hembra-hembra FIG.130

F - F - F TEES FIG.130

TÉS 150 LBS FG - FG - FG FIG.130

Adattatore a T F - F - F

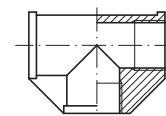

THREAD ROSCA	Part nº Referencia	€
1/8"	ZFIG13002	2,53
1/4"	ZFIG13004	3,18
3/8"	ZFIG13006	3,84
1/2"	ZFIG13008	5,11
3/4"	ZFIG13012	7,02
1"	ZFIG13016	10,71
1"1/4"	ZFIG13020	17,62
1"1/2"	ZFIG13024	21,36
2"	ZFIG13032	36,60
2"1/2"	ZFIG13040	70,41
3"	ZFIG13048	105,27
4"	ZFIG13060	165,83

Cruz roscada FIG.180

Threaded cross FIG.180

Croix égale 150 LBS FG FIG.180

Croce filettata femmina FIG.180

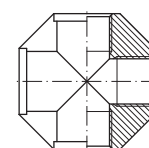

THREAD ROSCA	Part nº Referencia	€
1/8"	ZFIG18002	3,97
1/4"	ZFIG18004	4,98
3/8"	ZFIG18006	5,56
1/2"	ZFIG18008	8,52
3/4"	ZFIG18012	11,92
1"	ZFIG18016	17,62
1"1/4"	ZFIG18020	28,10
1"1/2"	ZFIG18024	32,87
2"	ZFIG18032	47,24
2"1/2"	ZFIG18040	93,11
3"	ZFIG18048	126,69
4"	ZFIG18060	239,74

Racores baja presión 150 LBS

Screwed fittings low pressure 150 LBS

Raccords basse pression 150 LBS

Raccordi bassa pressione 150 LBS

Unión 3 piezas hembra-hembra FIG.340

Female-female FIG.340

Union 3 pièces 150 LBS FG - FG FIG.340

Unione femmina-femmina FIG.340

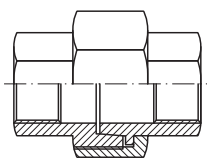

THREAD ROSCA	Part nº Referencia	€
1/8"	ZFIG34002	5,92
1/4"	ZFIG34004	7,12
3/8"	ZFIG34006	8,83
1/2"	ZFIG34008	10,31
3/4"	ZFIG34012	13,41
1"	ZFIG34016	17,25
1" 1/4	ZFIG34020	27,09
1" 1/2	ZFIG34024	31,60
2"	ZFIG34032	47,43
2" 1/2	ZFIG34040	73,71
3"	ZFIG34048	70,30
4"	ZFIG34060	101,58

Unión 3 piezas macho-hembra FIG.341

Male-female union FIG.341

Union 3 pièces 150 LBS MG - FG FIG.341

Unione maschio-femmina FIG.341

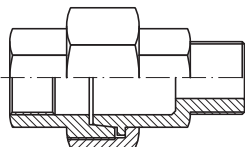

THREAD ROSCA	Part nº Referencia	€
1/4"	ZFIG34104	9,25
3/8"	ZFIG34106	9,97
1/2"	ZFIG34108	11,05
3/4"	ZFIG34112	14,10
1"	ZFIG34116	20,28
1" 1/4	ZFIG34120	31,93
1" 1/2	ZFIG34124	37,85
2"	ZFIG34132	53,56
2" 1/2	ZFIG34140	85,09
3"	ZFIG34148	120,41
4"	ZFIG34160	294,85

Macho soldar FIG.149

Welding male fig.149

Mâle à souder fig.149 inox

Maschio a saldare fig. 149 inox

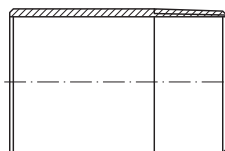

THREAD ROSCA	Part nº Referencia	€
1/4"	ZFIG14904	1,42
3/8"	ZFIG14906	1,62
1/2"	ZFIG14908	2,16
3/4"	ZFIG14912	2,96
1"	ZFIG14916	3,68
1" 1/4	ZFIG14920	5,72
1" 1/2	ZFIG14924	7,07
2"	ZFIG14932	8,58

Unión 3 piezas hembra-soldar FIG.340HS microfundido

Union 3 fem. welding pieces fig.340hs micro-casting

Union 3 pcs fem. à souder fig.340hs acier moulé

Unione a 3 pezzi f.saldare fig.340hs microfusione

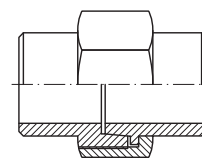

DN	Part nº Referencia	€
1/4	ZFIG34004S	7,48
3/8	ZFIG34006S	8,69
1/2	ZFIG34008S	10,31
3/4	ZFIG34012S	12,73
1	ZFIG34016S	17,59
1 1/4	ZFIG34020S	25,47
1 1/2	ZFIG34024S	28,30
2	ZFIG34032S	43,86

Unión 3 piezas soldar FIG.340S microfundido

Union 3 welding pieces fig. 340s micro-casting

Union 3 pièces à souder fig. 340s acier moulé

Unione a 3 pezzi a saldare fig.340s microfusione

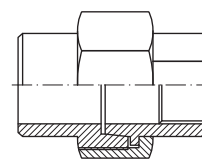

THREAD ROSCA	Part nº Referencia	€
1/4"	ZFIG34004HS	7,61
3/8"	ZFIG34006HS	9,03
1/2"	ZFIG34008HS	10,31
3/4"	ZFIG34012HS	13,07
1"	ZFIG34016HS	17,59
1" 1/4	ZFIG34020HS	26,41
1" 1/2	ZFIG34024HS	30,79
2"	ZFIG34032HS	46,22

Unión 3 piezas macho-soldar FIG.341MS microfundido

Union 3 welding male pieces fig.341ms micro-casting

Union 3 pcs mâle à souder fig.341ms acier moulé

Unione a 3 pezzi m.saldare fig.341ms microfusione

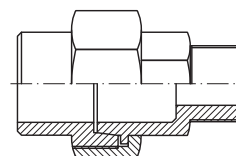

THREAD ROSCA	Part nº Referencia	€
1/4"	ZFIG34104MS	8,15
3/8"	ZFIG34106MS	9,10
1/2"	ZFIG34108MS	10,71
3/4"	ZFIG34112MS	14,55
1"	ZFIG34116MS	19,74
1" 1/4	ZFIG34120MS	29,04
1" 1/2	ZFIG34124MS	34,56
2"	ZFIG34132MS	52,55

Racores baja presión 150 LBS

Screwed fittings low pressure 150 LBS

Raccords basse pression 150 LBS

Raccordi bassa pressione 150 LBS

Válvula esfera paso total baja presión 3 piezas

Ball-valve low pressure full bore 3 pcs

Robinet basse pression 2 voies boisseau sphérique passage total 3 pcs

Rubinetto a sfera bassa pressione 3 pcs

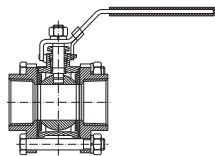

THREAD ROSCA	Part nº Referencia	€
1/4 BSP	BP2V3P14INOX	27,02
3/8 BSP	BP2V3P38INOX	27,02
1/2 BSP	BP2V3P12INOX	30,81
3/4 BSP	BP2V3P34INOX	41,44
1" BSP	BP2V3P11INOX	52,73
1" 1/4 BSP	BP2V3P114INOX	89,41
1" 1/2 BSP	BP2V3P112INOX	118,38
2" BSP	BP2V3P2INOX	166,28

Válvula esfera paso total baja presión 64 Bar

Ball-valve low pressure full bore 64 Bar

Robinet basse pression 2 voies boisseau sphérique passage total 64 Bar

Rubinetto a sfera bassa pressione passaggio totale 64 Bar

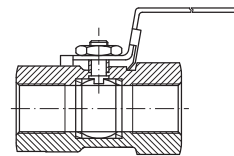

DN	THREAD ROSCA	Part nº Referencia	€
8	1/4" BSP	BP2V14INOX	17,11
10	3/8" BSP	BP2V38INOX	17,11
15	1/2" BSP	BP2V12INOX	20,01
20	3/4" BSP	BP2V34INOX	28,84
25	1" BSP	BP2V11INOX	39,62
32	1" 1/4 BSP	BP2V114INOX	62,39
40	1" 1/2 BSP	BP2V112INOX	76,10
50	2" BSP	BP2V2INOX	130,98
65	2" 1/2 BSP	BP2V212INOX	259,80
80	3" BSP	BP2V3INOX	378,18

Enchufes, Llaves y Componentes Hidráulicos

Couplings, Ball valves and Hydraulic Components

Coupleurs, Robinets et Composants Hydrauliques

Innesti rapidi, Rubinetti a sfera e Componenti Idraulici

Enchufes rápidos AISI 316

Quick couplings AISI 316
Coupleurs rapides AISI 316
Innesti rapidi AISI 316

207

Llaves de paso AISI 316

Ball valves AISI 316
Robinets AISI 316
Rubinetti AISI 316

209

Enchufes, Llaves y Racores Giratorios TrΔle

Quick couplings, ball valves and swivel fittings TrΔle
Coupleurs rapides, robinets et raccords tournants TrΔle
Innesti rapidi, rubinetti e giunti girevole TrΔle

211

Componentes hidráulicos AISI 316

Hydraulic Components AISI 316
Composants Hydrauliques AISI 316
Componenti Idraulici AISI 316

213

Manómetros AISI 316 con glicerina

Pressure gauges AISI 316 with glycerin
Manomètre AISI 316 avec glycérine
Manometri AISI 316 a bagno di glicerina

214

7

Enchufes rápidos AISI 316

Quick couplings AISI 316
Coupleurs rapides AISI 316
Innesti rapidi AISI 316

■ Enchufes rápidos / Quick couplings / Quick release couplings / Innesti rapidi

| 207

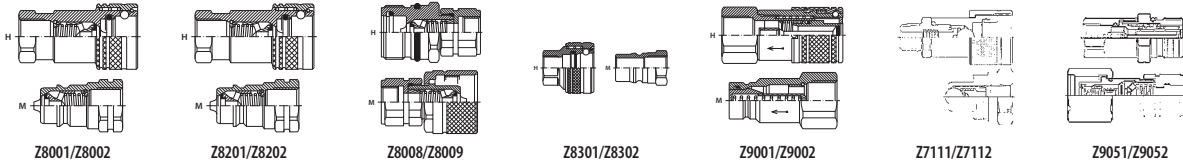

Llaves de paso AISI 316

Ball valves AISI 316
Robinets AISI 316
Rubinetti AISI 316

■ Llaves de paso / Ball valves / Robinets / Rubinetti

| 209

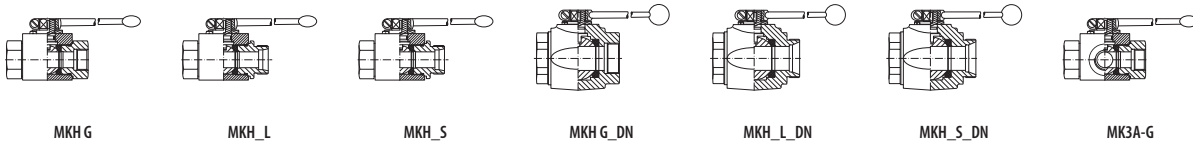

Enchufes, Llaves y Racores Giratorios TrΔle

Quick couplings, ball valves and swivel fittings TrΔle
 Coupleurs rapides, robinets et raccords tournants TrΔle
 Innesti rapidi, rubinetti e giunti girevole TrΔle

■ Enchufes rápidos TrΔle / Quick couplings TrΔle / Coupleurs rapides TrΔle / Innesti rapidi TrΔle

| 211

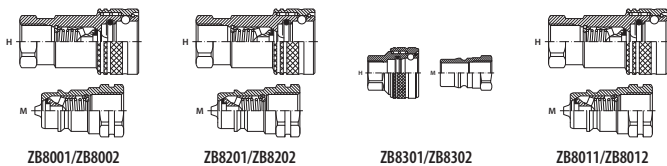

■ Racores Giratorios TrΔle / Swivel fittings TrΔle / Raccords tournants TrΔle / Giunti girevole TrΔle

| 211



■ Llaves de paso TrΔle / Ball valves TrΔle / Robinets TrΔle / Rubinetti TrΔle

| 212



Componentes hidráulicos AISI 316

Hydraulic Components AISI 316
Composants Hydrauliques AISI 316
Componenti Idraulici AISI 316

Reguladores caudal / Flow control valves / Régulateurs de débit / Regolatori di flusso

| 213



ZFT2251B



ZFT2253U

Protectores manómetro AISI 316 / Valves for manometers / Valves pour manomètres / Esclusori per manometro

| 213



ZFPE



ZFPEA

Anti-retornos / Check-valves / Clapet antiretour / Valvole di ritegno

| 213



ZFPR

Manómetros AISI 316 con glicerina

Pressure gauges AISI 316 with glycerin
Manomètre AISI 316 avec glycérine
Manometri AISI 316 a bagno di glicerina

Manómetros inox glicerina DN 63 / Pressure gauge DN 63 with glycerin / Manomètre avec glycérine DN 63 / Manometro DN 63 a bagno di glicerina

| 214



ZMF163..V



ZMF163..DB

Manómetros inox glicerina DN 100 / Pressure gauge DN 100 with glycerin / Manomètre avec glycérine DN 100 / Manometro DN 100 a bagno di glicerina

| 214



ZMF1100..V



ZMF1100DB

Enchufes rápidos AISI 316

Quick couplings AISI 316
Coupleurs rapides AISI 316
Innesti rapidi AISI 316

Enchufes de punzón ISO B

Quick coupling ISO B

Coupleurs rapides à clapet

Innesti a valvola ISO B

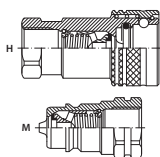

THREAD ROSCA	ISO SIZE TAMAÑO ISO	C. E.	Part nº Referencia	€
1/4" BSP	6,3	M	Z800104	41,00
3/8" BSP	10	M	Z800106	45,56
1/2" BSP	12,5	M	Z800108	52,99
3/4" BSP	20	M	Z800112	91,11
1" BSP	25	M	Z800116	141,73
1"1/4 BSP	40	M	Z800120	632,08
1"1/2 BSP	40	M	Z800124	632,08
2" BSP	50	M	Z800132	1.292,64
1/4" BSP	6,3	F	Z800204	91,11
3/8" BSP	10	F	Z800206	102,50
1/2" BSP	12,5	F	Z800208	134,67
3/4" BSP	20	F	Z800212	199,88
1" BSP	25	F	Z800216	311,20
1"1/4 BSP	40	F	Z800220	814,31
1"1/2 BSP	40	F	Z800224	814,31
2" BSP	50	F	Z800232	1.888,28

Enchufes de punzón ISO A

Quick coupling ISO A

Coupleurs rapides à clapet ISO A

Innesti a valvola ISO A

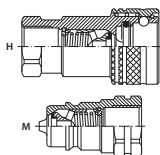

THREAD ROSCA	ISO SIZE TAMAÑO ISO	C. E.	Part nº Referencia	€
3/8" BSP	10	M	Z820106	45,56
1/2" BSP	12,5	M	Z820108	52,96
3/4" BSP	20	M	Z820112	91,11
1" BSP	25	M	Z820116	142,36
1"1/4 BSP	31,5	M	Z820120	353,06
1"1/2 BSP	40	M	Z820124	489,72
2" BSP	50	M	Z820132	939,58
3/8" BSP	10	F	Z820206	113,89
1/2" BSP	12,5	F	Z820208	113,89
3/4" BSP	20	F	Z820212	176,53
1" BSP	25	F	Z820216	282,73
1"1/4 BSP	31,5	F	Z820220	700,42
1"1/2 BSP	40	F	Z820224	882,64
2" BSP	50	F	Z820232	1.651,39

Enchufes auto-roscantes

Quick screw couplings

Coupleur rapide à visser filetage

Innesti rapidi a vite

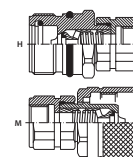

THREAD ROSCA	ISO SIZE TAMAÑO ISO	C. E.	Part nº Referencia	€
1/4" BSP	6,3	M	Z800804	154,89
3/8" BSP	10	M	Z800806	218,10
1/2" BSP	12,5	M	Z800808	245,72
3/4" BSP	20	M	Z800812	438,76
1" BSP	25	M	Z800816	556,35
1"1/4 BSP	40	M	Z800820	871,25
1"1/2 BSP	40	M	Z800824	871,25
1/4" BSP	6,3	F	Z800904	111,04
3/8" BSP	10	F	Z800906	154,60
1/2" BSP	12,5	F	Z800908	193,61
3/4" BSP	20	F	Z800912	322,31
1" BSP	25	F	Z800916	415,69
1"1/4 BSP	40	F	Z800920	654,86
1"1/2 BSP	40	F	Z800924	654,86

Enchufes paso total ISO B

Quick coupling free flow ISO B

Coupleurs rapides à clapet passage total ISO B

Innesti a passaggio libero

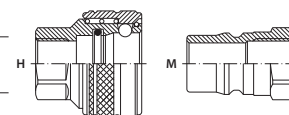

THREAD ROSCA	ISO SIZE TAMAÑO ISO	C. E.	Part nº Referencia	€
1/8" BSP	5	M	Z830102	27,25
1/4" BSP	6,3	M	Z830104	28,05
3/8" BSP	10	M	Z830106	30,51
1/2" BSP	12,5	M	Z830108	33,67
3/4" BSP	20	M	Z830112	59,22
1" BSP	25	M	Z830116	82,69
1"1/4 BSP	40	M	Z830120	217,66
1"1/2 BSP	40	M	Z830124	217,66
2" BSP	50	M	Z830132	431,92
1/8" BSP	5	F	Z830202	75,47
1/4" BSP	6,3	F	Z830204	76,70
3/8" BSP	10	F	Z830206	92,52
1/2" BSP	12,5	F	Z830208	106,92
3/4" BSP	20	F	Z830212	151,50
1" BSP	25	F	Z830216	234,38
1"1/4 BSP	40	F	Z830220	425,17
1"1/2 BSP	40	F	Z830224	425,17
2" BSP	50	F	Z830232	892,32

Enchufes rápidos AISI 316

Quick couplings AISI 316
Coupleurs rapides AISI 316
Innesti rapidi AISI 316

Enchufes de válvula plana

Flat face quick coupling

Coupleurs à clapet face plane

Innesti a faccia piana

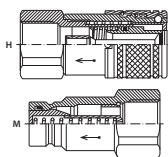

THREAD ROSCA	ISO SIZE TAMAÑO ISO	C. E.	Part nº Referencia	€
1/4" BSP	6,3	M	Z900104	143,28
3/8" BSP	12,5	M	Z900106	176,86
1/2" BSP	12,5	M	Z900108	202,98
3/4" BSP	20	M	Z900112	277,74
1" BSP	25	M	Z900116	299,79
1"1/4 BSP	25	M	Z900120	293,26
1"1/2 BSP	40	M	Z900124	637,78
2" BSP	50	M	Z900132	1.423,61
1/4" BSP	6,3	F	Z900204	221,30
3/8" BSP	12,5	F	Z900206	264,37
1/2" BSP	12,5	F	Z900208	308,58
3/4" BSP	20	F	Z900212	412,52
1" BSP	25	F	Z900216	454,83
1"1/4 BSP	25	F	Z900220	740,28
1"1/2 BSP	40	F	Z900224	1.332,50
2" BSP	50	F	Z900232	2.448,61

Bola altissima presión 700 bar ac. presión inox

Quick coupling ball type very high pressure 700 bar

Coupleur rapide à bille haute pression 700 bar

Innesti rapido a sfera 700 bar

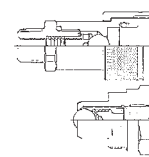

THREAD ROSCA	ISO SIZE TAMAÑO ISO	C. E.	Part nº Referencia	€
3/8" NPT	10	M	Z711106	130,97
3/8" NPT	10	F	Z711206	108,19

Válvula plana autoroscante ac. presión inox

Flat face screw coupling

Coupleur rapide à clapet face plane à visser

Innesto rapido a faccia piana a vite

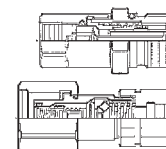

THREAD ROSCA	ISO SIZE TAMAÑO ISO	C. E.	Part nº Referencia	€
3/8" BSP	10	M	Z905106	240,88
1/2" BSP	12.5	M	Z905108	298,96
3/4" BSP	16	M	Z905112	305,22
1" BSP	19	M	Z905116	433,92
1"1/4 BSP	25	M	Z905120	671,94
1"1/2 BSP	40	M	Z905124	*
3/8" NPT	10	F	Z905206	203,86
1/2" BSP	12.5	F	Z905208	293,26
3/4" BSP	16	F	Z905212	317,75
1" BSP	19	F	Z905216	398,61
1"1/4 BSP	25	F	Z905220	575,14
1"1/2 BSP	40	F	Z905224	*

Llaves de paso AISI 316

Ball valves AISI 316

Robinetts AISI 316

Rubinetti AISI 316

Crimp fittings for hoses

Pipe fittings DIN 2353

Flare fittings JIC 37° / SAE Flanges

Adaptors

Welding fittings

Industrial fittings

Couplings, Ball valves and Hydraulic Components

Llave 2 vías rosca hembra BSP

2 Way ball-valves BSP female ISO 228

Robinet haute pression 2 voies boisseau sphérique femelle BSP

Rubinetto a sfera femmina - femmina BSP

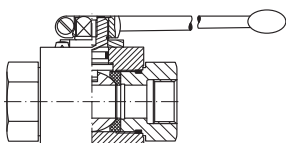

DN	THREAD ROSCA	Part n° Referencia	€
4	1/8" BSP	MKH G 1/8	195,35
6	1/4" BSP	MKH G 1/4	126,15
10	3/8" BSP	MKH G 3/8	165,52
13	1/2" BSP	MKH G 1/2	170,30
16	5/8" BSP	MKH G 5/8	393,85
20	3/4" BSP	MKH G 3/4	399,47
25	1" BSP	MKH G 1	441,22
25	1" 1/4 BSP	MKH G 1 1/4 DN25	556,25
25	1" 1/2 BSP	MKH G 1 1/2 DN25	590,41

Llave 2 vías tubo rígido serie ligera

2 Way ball-valves: tube connection serie L DIN 2353

Robinet haute pression 2 voies boisseau sphérique pour tube rigide série légère

Rubinetto a sfera maschio DIN 2353 - L -

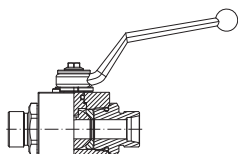

DN	PIPE TUBO		Part n° Referencia	€
4	6 L	6 L	MKH 6 L	259,73
6	8 L	8 L	MKH 8 L	227,96
8	10 L	10 L	MKH 10 L	229,54
10	12 L	12 L	MKH 12 L	210,84
13	15 L	15 L	MKH 15 L	245,87
16	18 L	18 L	MKH 18 L	291,97
20	22 L	22 L	MKH 22 L	428,25
25	28 L	28 L	MKH 28 L	545,51
25/32	35 L	35 L	MKH 35 L	572,19
25/40	42 L	42 L	MKH 42 L	718,40

Llave 2 vías tubo rígido serie pesada

2 Way ball-valves: tube connection serie S DIN 2353

Robinet haute pression 2 voies boisseau sphérique pour tube rigide série lourde

Rubinetto a sfera maschio DIN 2353 - S -

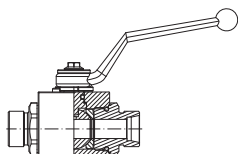

DN	PIPE TUBO		Part n° Referencia	€
4	8 S	8 S	MKH 8 S	245,29
6	10 S	10 S	MKH 10 S	239,57
8	12 S	12 S	MKH 12 S	201,91
10	14 S	14 S	MKH 14 S	265,51
13	16 S	16 S	MKH 16 S	217,14
16	20 S	20 S	MKH 20 S	368,38
20	25 S	25 S	MKH 25 S	398,52
13	20 S	20 S	MKH 20 S DN13	297,36
25	30 S	30 S	MKH 30 S	459,60
25/32	38 S	38 S	MKH 38 S	523,98

Llave 2 vías rosca hembra BSP paso total

Ball-valves BSP female

Robinet haute pression 2 voies boisseau sphérique femelle

Rubinetto a sfera femmina - femmina BSP

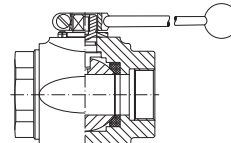

DN	THREAD ROSCA	Part n° Referencia	€
32	1" 1/4 BSP	MKH G 1 1/4 DN32	948,03
40	1" 1/2 BSP	MKH G 1 1/2 DN40	1.271,14
50	2" BSP	MKH G 2 DN50	1.667,57

Llave 2 vías tubo rígido L paso total

Ball-valves: tube connection serie L DIN 2353 full bore

Robinet haute pression 2 voies boisseau sphérique Métrique série légère passage total

Rubinetto a sfera maschio DIN 2353 - L -

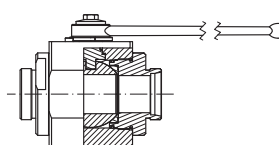

DN	PIPE TUBO		Part n° Referencia	€
35	35 L	35 L	MKH 35 L DN35	1.099,16
42	42 L	42 L	MKH 42 L DN42	1.261,69

Llave 2 vías tubo rígido S paso total

Ball-valves: tube connection serie S DIN 2353 full bore

Robinet haute pression 2 voies boisseau sphérique Métrique série légère passage total

Rubinetto a sfera maschio DIN 2353 - S -

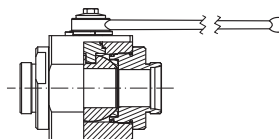

DN	PIPE TUBO		Part n° Referencia	€
32	38 S	38 S	MKH 38 S DN32	1.081,31

Llave 3 vías hembra - hembra - hembra BSP paso en L

3 Way ball-valve female BSP L flow

Robinet haute pression 3 voies boisseau sphérique femelle BSP passage en L

Rubinetto a sfera 3 vie femmina BSP passaggio en L

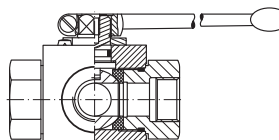

DN	THREAD ROSCA	Part n° Referencia	€
4	1/8" BSP	MK3A-G 1/8	423,10
6	1/4" BSP	MK3A-G 1/4	352,37
10	3/8" BSP	MK3A-G 3/8	469,05
13	1/2" BSP	MK3A-G 1/2	410,44
20	3/4" BSP	MK3A-G 3/4	836,38
25	1" BSP	MK3A-G 1	1.174,88
25	1" 1/4 BSP	MK3A-G 1 1/4	1.222,93
25	1" 1/2 BSP	MK3A-G 1 1/2	1.306,06

Ilaves de paso

Ball valves
Robinets
Rubinetti a sfera

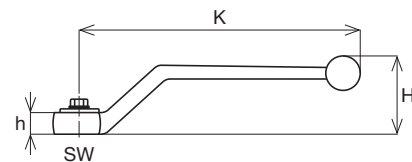

Manetas

Handles for ball-valves
Leviers pour robinets
Maniglia

Para llaves de paso For ball-valves Pour robinets Per rubinetti a sfera	SW	Standard zinc Standard zinc Standard zinc Standard zinco		Acero Steel Acier Acciaio		INOX/SS316L	
		Referencia Part no. Référence Codice	€	Referencia Part no. Référence Codice	€	Referencia Part no. Référence Codice	€
Serie BSP 1/8 - 1/4 - 3/8 - 1/2 - 5/8	9	A60013155330	*	C600063	*	Z60013155330	*
Serie DIN 6 - 8 - 10 - 12 - 14 - 15 - 16 - 18							
Serie BSP 3/4 - 1 - 1 1/4	14	-	*	C708618	*	Z60013155331	*
Serie DIN 22 - 25 - 28 - 30 - 35 - 38							
Serie BSP 1 1/4 - 1 1/2 - 2	17	-	*	-	*	Z60013155332	*
Serie DIN 35 - 38 - 42							

Solo se suministra en aluminio

Only supplied in aluminium
Seulement disponible en aluminium
Disponibile solo in alluminio

Para llaves de paso For ball-valves Pour robinets Per rubinetti a sfera	SW	Referencia Part no. Référence Codice	€
Serie BSP 5/8	12	L501741	*
Serie DIN 15 - 16 - 18			

Manetas

Handles for ball-valves
Leviers pour robinets
Maniglia

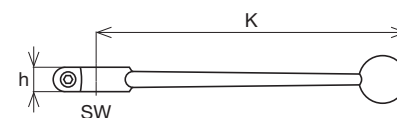

Para llaves de paso For ball-valves Pour robinets Per rubinetti a sfera	SW	Zinc Zinc Zinc Zinco		Aluminio Aluminium Aluminium Alluminio	
		Referencia Part no. Référence Codice	€	Referencia Part no. Référence Codice	€
Serie BSP 1/8 - 1/4 - 3/8 - 1/2 - 5/8	9	AR603722	*	-	*
Serie DIN 6 - 8 - 10 - 12 - 14 - 15 - 16 - 18					
Serie BSP 3/4 - 1 - 1 1/4	14	A60013155331	*	LR606745	*
Serie DIN 22 - 25 - 28 - 30 - 35 - 38					
Serie BSP 1 1/4 - 1 1/2 - 2	17	-	*	LR801799	*
Serie DIN 35 - 38 - 42					

Enchufes, Llaves y Racores Giratorios TrΔle

Quick couplings, ball valves and swivel fittings TrΔle
Coupleurs rapides, robinets et raccords tournants TrΔle
Innesti rapidi, rubinetti e giunti girevole TrΔle

Enchufes ISO A TrΔle

Quick couplings ISO A TrΔle

Coupleurs ISO A TrΔle

Innesti rapidi ISO A TrΔle

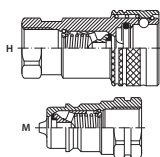

DN	THREAD ROSCA	C. E.	Part n° Referencia	€
10	1/4" BSP	M	ZB820104	*
10	3/8" BSP	M	ZB820106	27,86
13	1/2" BSP	M	ZB820108	46,91
20	3/4" BSP	M	ZB820112	85,28
25	1" BSP	M	ZB820116	118,45
10	1/4" BSP	F	ZB820204	*
10	3/8" BSP	F	ZB820206	66,66
12	1/2" BSP	F	ZB820208	111,42
20	3/4" BSP	F	ZB820212	199,61
25	1" BSP	F	ZB820216	278,49

Enchufes ISO B TrΔle

Quick couplings ISO B TrΔle

Coupleurs ISO B TrΔle

Innesti rapidi ISO B TrΔle

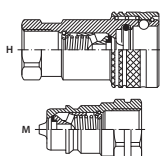

DN	THREAD ROSCA	C. E.	Part n° Referencia	€
6	1/4" BSP	M	ZB800104	17,00
10	3/8" BSP	M	ZB800106	26,91
13	1/2" BSP	M	ZB800108	45,32
20	3/4" BSP	M	ZB800112	82,43
25	1" BSP	M	ZB800116	114,44
6	1/4" BSP	F	ZB800204	41,19
10	3/8" BSP	F	ZB800206	64,42
13	1/2" BSP	F	ZB800208	107,64
20	3/4" BSP	F	ZB800212	192,91
25	1" BSP	F	ZB800216	269,11

Racores giratorios rectos

Straight swivel fittings

Raccord tournant droit

Giunti girevoli dritti



THREAD ROSCA	Part n° Referencia	€
1/4" BSP	Z GGL 1/4	196,86
3/8" BSP	Z GGL 3/8	225,93
1/2" BSP	Z GGL 1/2	253,47
3/4" BSP	Z GGL 3/4	323,85
1" BSP	Z GGL 1	433,50
1" 1/4 BSP	Z GGL 1 1/4	605,37
1" 1/2 BSP	Z GGL 1 1/2	1.014,33
2" BSP	Z GGL 2	1.360,00

Enchufes Paso Total TrΔle

Quick couplings free flow TrΔle

Coupleurs passage total TrΔle

Innesti a passaggio libero TrΔle

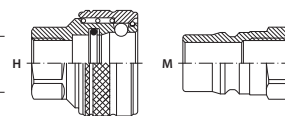

DN	THREAD ROSCA	C. E.	Part n° Referencia	€
6	1/4" BSP	M	ZB830104	27,32
10	3/8" BSP	M	ZB830106	30,90
13	1/2" BSP	M	ZB830108	33,88
20	3/4" BSP	M	ZB830112	56,99
25	1" BSP	M	ZB830116	74,83
6	1/4" BSP	F	ZB830204	74,83
10	3/8" BSP	F	ZB830206	90,10
13	1/2" BSP	F	ZB830208	103,32
20	3/4" BSP	F	ZB830212	139,55
25	1" BSP	F	ZB830216	223,71

Enchufes ISO A NPT TrΔle

Quick couplings ISO A NPT TrΔle

Coupleurs ISO A NPT TrΔle

Innesti rapidi ISO A NPT TrΔle

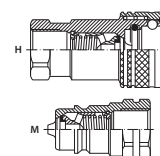

DN	THREAD ROSCA	C. E.	Part n° Referencia	€
6	1/4" NPT	M	ZB801104	*
10	3/8" NPT	M	ZB801106	*
13	1/2" NPT	M	ZB801108	*
20	3/4" NPT	M	ZB801112	*
25	1" NPT	M	ZB801116	*
6	1/4" NPT	F	ZB801204	*
10	3/8" NPT	F	ZB801206	*
13	1/2" NPT	F	ZB801208	*
20	3/4" NPT	F	ZB801212	*
25	1" NPT	F	ZB801216	*

Racores giratorios 90°

Elbow 90° swivel female

Raccord tournant coude 90°

Giunti girevoli 90°



THREAD ROSCA	Part n° Referencia	€
1/4" BSP	Z GG90 1/4	246,33
3/8" BSP	Z GG90 3/8	298,86
1/2" BSP	Z GG90 1/2	366,18
3/4" BSP	Z GG90 3/4	448,80
1" BSP	Z GG90 1	604,35
1" 1/4 BSP	Z GG90 1 1/4	942,48
1" 1/2 BSP	Z GG90 1 1/2	1.448,40
2" BSP	Z GG90 2	2.079,67

Enchufes, Llaves y Racores Giratorios TrΔle

Quick couplings, ball valves and swivel fittings TrΔle
Coupleurs rapides, robinets et raccords tournants TrΔle
Innesti rapidi, rubinetti e giunti girevole TrΔle

Llave 2 vías rosca hembra BSP TrΔle

2 ways ball valve female BSP TrΔle

Robinet haute pression 2 voies boisseau sphérique femelle BSP TrΔle

Rubinetto a sfera femmina BSP TrΔle



DN	THREAD ROSCA	Part nº Referencia	€
4	1/8" BSP	ZGB2V 1/8	65,84
6	1/4" BSP	ZGB2V 1/4	110,31
10	3/8" BSP	ZGB2V 3/8	134,58
13	1/2" BSP	ZGB2V 1/2	149,40
20	3/4" BSP	ZGB2V 3/4	228,65
25	1" BSP	ZGB2V 1	316,34

Llave 2 vías tubo rígido serie ligera TrΔle

2 ways ball valve: tube connector light serie TrΔle

Robinet haute pression 2 voies boisseau sphérique sortie pour tube rigide Série légère TrΔle

Rubinetto a sfera DIN 2353 - L TrΔle



DN	PIPE TUBO		Part nº Referencia	€
6	8 L	8 L	ZGB2V 8 L	132,77
8	10 L	10 L	ZGB2V 10 L	132,77
10	12 L	12 L	ZGB2V 12 L	153,96
13	15 L	15 L	ZGB2V 15 L	160,67
16	18 L	18 L	ZGB2V 18 L	160,67
20	22 L	22 L	ZGB2V 22 L	327,62

Llave 2 vías tubo rígido serie pesada TrΔle

2 ways ball valve: tube connector heavy serie TrΔle

Robinet haute pression 2 voies boisseau sphérique sortie pour tube rigide Série lourde TrΔle

Rubinetto a sfera DIN 2353 - S TrΔle



DN	PIPE TUBO		Part nº Referencia	€
4	8 S	8 S	ZGB2V 8 S	132,77
6	10 S	10 S	ZGB2V 10 S	132,77
8	12 S	12 S	ZGB2V 12 S	132,77
10	14 S	14 S	ZGB2V 14 S	153,96
13	16 S	16 S	ZGB2V 16 S	160,67
16	20 S	20 S	ZGB2V 20 S	160,67
20	25 S	25 S	ZGB2V 25 S	327,62

Llave 2 vías rosca hembra NPT TrΔle

2 ways ball valve female NPT TrΔle

Robinet haute pression 2 voies boisseau sphérique femelle NPT TrΔle

Rubinetto a sfera femmina NPT TrΔle



DN	THREAD ROSCA	Part nº Referencia	€
6	1/4" NPT	ZGB2V 1/4 NPT	*
10	3/8" NPT	ZGB2V 3/8 NPT	*
12	1/2" NPT	ZGB2V 1/2 NPT	*
19	3/4" NPT	ZGB2V 3/4 NPT	*

Componentes hidráulicos AISI 316

Hydraulic Components AISI 316
Composants Hydrauliques AISI 316
Componenti Idraulici AISI 316

Válvulas bidireccionales

Bidirectional flow control valve

Régulateur débit bidirectionnel

Valvola di regolazione bidirezionale



THREAD ROSCA		FILTRATION DEGREE GRADO DE FILTRACIÓN	Part nº Referencia	€
1/4" BSP	M17x1	25µ	ZFT2251B04	128,11
3/8" BSP	M20x1	25µ	ZFT2251B06	158,19
1/2" BSP	M25x1,5	25µ	ZFT2251B08	246,88
3/4" BSP	M30x1,5	25µ	ZFT2251B12	332,60

Válvulas unidireccionales

Unidirectional flow control valve

Régulateur débit unidirectionnel

Valvola di regolazione unidirezionale



THREAD ROSCA		FILTRATION DEGREE GRADO DE FILTRACIÓN	Part nº Referencia	€
1/4" BSP	M17x1	25µ	ZFT2253U04	150,81
3/8" BSP	M20x1	25µ	ZFT2253U06	183,64
1/2" BSP	M25x1,5	25µ	ZFT2253U08	261,23
3/4" BSP	M30x1,5	25µ	ZFT2253U12	350,80

Protector manómetro recto

Pressure gauge protector (line mounting)

Isolateur de manomètre droit (en ligne)

Esclusore per manometro diritto



THREAD ROSCA	DESCRIPTION DESCRIPCIÓN	Part nº Referencia	€	
1/4" BSP	1/4" BSPT	RIGHT	Z FPE 1G 1/4	135,45

Protector manómetro 90°

90° pressure gauge protector (line mounting)

Isolateur de manomètre coudé a 90° (en ligne)

Esclusore per manometro a 90°



THREAD ROSCA	DESCRIPTION DESCRIPCIÓN	Part nº Referencia	€	
1/4" BSP	1/4" BSPT	90°	Z FPEA 1G 1/4	135,45

Anti-retorno

Check-valves

Anti-retour inox

Valvole di ritengo in linea



THREAD ROSCA	SETTING (bar) TARAJE (bar)	Part nº Referencia	€
1/4" BSP	0,5	Z FPR 1/4	49,84
1/4" BSP	2,5	Z FPR 1/4-2.5	90,41
1/4" BSP	5	Z FPR 1/4-5	90,41
1/4" BSP	10	Z FPR 1/4-10	92,99
3/8" BSP	0,5	Z FPR 3/8	60,57
3/8" BSP	2,5	Z FPR 3/8-2.5	100,15
3/8" BSP	5	Z FPR 3/8-5	100,15
3/8" BSP	10	Z FPR 3/8-10	100,15
1/2" BSP	0,5	Z FPR 1/2	69,15
1/2" BSP	2,5	Z FPR 1/2-2.5	119,22
1/2" BSP	5	Z FPR 1/2-5	119,22
1/2" BSP	10	Z FPR 1/2-10	119,22
3/4" BSP	0,5	Z FPR 3/4	121,70
1" BSP	0,5	Z FPR 1	192,71
1" 1/4 BSP	0,5	Z FPR 1 1/4	363,53
1" 1/2 BSP	0,5	Z FPR 1 1/2	446,46

Para otras presiones de tarado estandard, consultar / For other standard spring pressures, consult us / Pour d'autres pressions ressort standard, consultez-nous

Manómetros AISI 316 con glicerina

Pressure gauges AISI 316 with glycerin

Manomètre AISI 316 avec glycérine

Manometri AISI 316 a bagno di glicerina

Manómetros DN 63 salida vertical

Pressure gauge DN 63 vertical connection

Manomètre DN 63 sortie verticale

Manometro DN 63 radiale



THREAD ROSCA	SCALE (bar) ESCALA (bar)	Part nº Referencia	€
1/4" BSP	0-1	ZMFI6304001V	*
1/4" BSP	0-2.5	ZMFI63042.5V	*
1/4" BSP	0-4	ZMFI6304004V	*
1/4" BSP	0-6	ZMFI6304006V	29,02
1/4" BSP	0-10	ZMFI6304010V	29,02
1/4" BSP	0-16	ZMFI6304016V	29,02
1/4" BSP	0-25	ZMFI6304025V	29,02
1/4" BSP	0-40	ZMFI6304040V	29,02
1/4" BSP	0-60	ZMFI6304060V	29,02
1/4" BSP	0-100	ZMFI6304100V	29,02
1/4" BSP	0-160	ZMFI6304160V	29,02
1/4" BSP	0-250	ZMFI6304250V	29,02
1/4" BSP	0-400	ZMFI6304400V	29,02
1/4" BSP	0-600	ZMFI6304600V	29,02
1/4" BSP	0-1000	ZMFI63041000V	*

*Caja AISI 304 (AISI 316L Consultar) / *Box AISI 304 (AISI 316L On request) / *Boite AISI 304 (AISI 316L Sur demande) / *Cassa AISI 304 (AISI 316L Su richiesta)

Manómetros DN 63 salida posterior

Pressure gauge DN 63 rear connection

Manomètre DN 63 sortie arrière

Manometro DN 63 assiale flangiato



THREAD ROSCA	SCALE (bar) ESCALA (bar)	Part nº Referencia	€
1/4" BSP	0-1	ZMFI6304001DB	*
1/4" BSP	0-2.5	ZMFI63042.5DB	*
1/4" BSP	0-4	ZMFI6304004DB	*
1/4" BSP	0-6	ZMFI6304006DB	*
1/4" BSP	0-10	ZMFI6304010DB	32,24
1/4" BSP	0-16	ZMFI6304016DB	32,24
1/4" BSP	0-25	ZMFI6304025DB	32,24
1/4" BSP	0-40	ZMFI6304040DB	*
1/4" BSP	0-60	ZMFI6304060DB	32,24
1/4" BSP	0-100	ZMFI6304100DB	*
1/4" BSP	0-160	ZMFI6304160DB	32,24
1/4" BSP	0-250	ZMFI6304250DB	32,24
1/4" BSP	0-400	ZMFI6304400DB	32,24
1/4" BSP	0-600	ZMFI6304600DB	*

*Caja AISI 304 (AISI 316L Consultar) / *Box AISI 304 (AISI 316L On request) / *Boite AISI 304 (AISI 316L Sur demande) / *Cassa AISI 304 (AISI 316L Su richiesta)

Manómetros DN 100 salida vertical

Pressure gauge DN 100 vertical connection

Manomètre DN 100 sortie verticale

Manometro DN 100 radiale



THREAD ROSCA	SCALE (bar) ESCALA (bar)	Part nº Referencia	€
1/2" BSP	0-1	ZMFI10008001V	*
1/2" BSP	0-2.5	ZMFI1000802.5V	*
1/2" BSP	0-4	ZMFI10008004V	*
1/2" BSP	0-6	ZMFI10008006V	*
1/2" BSP	0-10	ZMFI10008010V	49,33
1/2" BSP	0-16	ZMFI10008016V	49,33
1/2" BSP	0-25	ZMFI10008025V	49,33
1/2" BSP	0-40	ZMFI10008040V	49,33
1/2" BSP	0-60	ZMFI10008060V	49,33
1/2" BSP	0-100	ZMFI10008100V	49,33
1/2" BSP	0-160	ZMFI10008160V	49,33
1/2" BSP	0-250	ZMFI10008250V	49,33
1/2" BSP	0-400	ZMFI10008400V	49,33
1/2" BSP	0-600	ZMFI10008600V	49,33

*Caja AISI 304 (AISI 316L Consultar) / *Box AISI 304 (AISI 316L On request) / *Boite AISI 304 (AISI 316L Sur demande) / *Cassa AISI 304 (AISI 316L Su richiesta)

Manómetros DN 100 salida posterior

Pressure gauge DN 100 rear connection

Manomètre DN 100 sortie arrière

Manometro DN 100 assiale flangiato



THREAD ROSCA	SCALE (bar) ESCALA (bar)	Part nº Referencia	€
1/2" BSP	0-1	ZMFI10008001DB	*
1/2" BSP	0-2.5	ZMFI1000802.5DB	*
1/2" BSP	0-4	ZMFI10008004DB	*
1/2" BSP	0-6	ZMFI10008006DB	*
1/2" BSP	0-10	ZMFI10008010DB	53,12
1/2" BSP	0-16	ZMFI10008016DB	53,12
1/2" BSP	0-25	ZMFI10008025DB	53,12
1/2" BSP	0-40	ZMFI10008040DB	53,12
1/2" BSP	0-60	ZMFI10008060DB	53,12
1/2" BSP	0-100	ZMFI10008100DB	53,12
1/2" BSP	0-160	ZMFI10008160DB	53,12
1/2" BSP	0-250	ZMFI10008250DB	53,12
1/2" BSP	0-400	ZMFI10008400DB	53,12
1/2" BSP	0-600	ZMFI10008600DB	53,12

*Caja AISI 304 (AISI 316L Consultar) / *Box AISI 304 (AISI 316L On request) / *Boite AISI 304 (AISI 316L Sur demande) / *Cassa AISI 304 (AISI 316L Su richiesta)

Condiciones de venta

General conditions of sale

GENERALIDADES

Estas condiciones así como las eventuales condiciones especiales acordadas en el contrato rigen para todas las entregas y todas las prestaciones. Las condiciones de compra del cliente que sean distintas a las aquí establecidas no llegarán a formar parte del contrato al aceptar el pedido. Los contratos se celebran, salvo en el caso de que se haya acordado lo contrario, mediante confirmación escrita del proveedor. En ningún caso, las Condiciones Generales y/o Específicas de Compra del Comprador, anularan o sustituirán estas Condiciones Generales de Venta.

La aceptación de nuestras ofertas implica tácitamente la de todas las condiciones aquí detalladas, salvo las especiales acordadas por escrito, particularmente en la misma Oferta o detalladas en nuestro acuse de recepción de pedido, únicos documentos que nos obligan ante el Cliente.

DICSA se reserva el derecho de propiedad y el derecho de propiedad intelectual de muestras, presupuestos, planos e información en forma material o inmaterial así como en forma electrónica; el acceso de terceros a éstos ha de impedirse.

OFERTAS Y PEDIDOS

Los precios se entienden, caso de no expresar lo contrario para mercadería situada en nuestro almacén, incluyendo el cargado de ésta, pero sin incluir el embalaje ni el transporte al lugar de recepción, ni impuestos –que serán siempre a cargo del comprador–, así como tampoco la puesta en marcha en el emplazamiento. Todas las operaciones de transporte, seguro, manutención y entrega son a cuenta y riesgo del Comprador.

Las ofertas incluyen solamente los materiales y artículos en ellas especificados disponibles en stock salvo agotamiento y por el plazo de validez determinado en las mismas.

Los estudios u ofertas de material están basados en los precios vigentes en la fecha de su realización, y si, debido a alteraciones en el coste de los materiales, modificación de aranceles o a cualquier otra causa, el nivel de precios fuese revisado, los precios que se aplicarían serían aquellos que rijan en la fecha del suministro, a menos que la oferta sea aceptada dentro del plazo de validez que en la misma se fije.

Los precios no incluyen, excepto notificación expresa, el montaje y la puesta en marcha de los materiales suministrados, los fluidos recomendados por los servicios técnicos de los fabricantes, los contenedores tanto rígidos como elásticos de los materiales, así como el estudio de implantación de los distintos materiales.

DICSA podrá variar el precio, como consecuencia de cualquier ley que afecte a materiales, salarios o a las horas de trabajo y también a posible cambios en la paridad de la moneda, en elementos de importación.

Los pedidos no serán tomados en consideración a menos que vengan acompañados de la cantidad a cuenta prevista en nuestra Oferta, si así se ha establecido. La aceptación de la Oferta supondrá igualmente la aceptación sin reservas de estas Condiciones Generales de Venta.

ESTUDIOS, PLANOS Y DISEÑOS

La información relacionada con la oferta, tal como planos, diseños, dibujos catálogos y/u otra documentación técnica, es solamente informativa y tienen como objeto dar una imagen general de los materiales en ellos descritos, no formando parte del contrato a menos que haya habido algún acuerdo por escrito. DICSA no aceptará ningún tipo de responsabilidad por la inexactitud u omisión de dicha documentación.

El Cliente deberá hacer siempre un estudio previo de compatibilidad y de montaje de los elementos en su instalación y será el único responsable de la puesta en conformidad de dicha instalación con las distintas reglamentaciones vigentes.

En presupuestos, planos, esquemas y otras informaciones técnicas, mantendremos reservado el derecho de propiedad y de realización, no permitiendo que estos sean facilitados a terceros sin nuestro previo consentimiento escrito.

DICSA se reserva el derecho de propiedad de la mercancía suministrada hasta el pago completo del precio establecido. DICSA se reserva el derecho de propiedad de los planos de la mercancía, que no serán facilitados ni vendidos a terceros en ningún caso.

TRABAJOS IN SITU

Los presupuestos de los trabajos realizados en el lugar de la obra del cliente son considerados orientativos, debido a las características particulares y especiales que pueden representar, no pudiendo dar lugar, excepto acuerdo definitivo entre las partes, en precios definitivos.

REPARACIÓN

Los trabajos de reparación no se empezarán hasta la aceptación escrita, por parte del Cliente, del presupuesto y de las condiciones que se establezcan.

En el supuesto de que el presupuesto no sea aceptado por el Cliente en el plazo de un mes, los gastos derivados del desmontaje, almacenaje, peritaje y portes correrán a cargo del Cliente. Si el Cliente solicita la reparación antes de aceptar el presupuesto, los trabajos se llevarán a cabo lo antes posible y, por su parte, el Cliente deberá aceptar el coste final de la reparación.

GENERAL TERMS

These conditions, together with the eventual specific conditions accorded in the contract, apply to all deliveries and all services. The purchase conditions of the customer, if different from those herein established, will not be part of the contract on having accepted the order.

The contracts are concluded, unless otherwise agreed upon by the Parties in writing, by means of written confirmation of the supplier. The General Conditions and / or Specific Conditions of Purchase of the Buyer, cannot, in no case, cancel or replace these General Conditions of Sale.

The acceptance of our offers implies tacitly the acceptance of all the conditions detailed herein, except the special ones that have the agreement in writing, particularly in the same offer or detailed in our accuse of receipt of order, the only documents that oblige us before the Customer. DICSA has the right of property and the right of intellectual property of samples, budgets, technical documentation and information in material or immaterial form as well as in electronic form; the access of third parties to these documents must be forbidden.

OFFERS AND ORDERS

Except in case of having expressed the opposite, the prices include the merchandise placed in our store, including its loading, but without including the packing nor the transport to the place of receipt, nor taxes, nor the getting started - these will always be at the expense of the customer. All the operations of transport, insurance, handling and delivery are on the account and risk of the Customer.

The offers include only the materials and products expressed in them, available in stock until end of stock, with the term of validity expressed in the same offers.

The studies or offers of material are based on the prices on the date the offer was made, and if, due to changes in the cost of the materials, modification of duties or to any other reason, the level of prices was checked, the prices that would be applied would be those that apply in the date of the delivery, unless the offer is accepted in the term of validity expressed in it.

The prices do not include, unless specific notification, the assembly and the getting started of the supplied materials, the fluids recommended by the technical services of the suppliers, the containers of the materials, as well as the study of the setting up of the different materials. DICSA may change the price, as a consequence of any law that concerns materials, wages, or the working hours, but also as a consequence of probable changes in the parity of the currency since it concerns the elements of import.

The orders will not be taken in consideration unless they are provided with the specific amount in our account, foreseen in our Offer, if this condition has been pre-established. The acceptance of the Offer will suppose equally the acceptance without reserve of these General Conditions of Sale.

STUDIES, TECHNICAL DOCUMENTATION

The information related to the offer, as technical documentation, designs, drawings, catalogues and / or any other technical documentation, is only informative and they have as object to give a general image of the materials described in them, they do not form a part of the contract unless written agreement. DICSA will not accept any type of responsibility for inaccuracy or omission of the above mentioned documentation.

The Customer will always have to do a previous study of compatibility and of assembly of the elements in his installation and will be the only responsible for the putting in conformity of the above mentioned installation with the current regulations. In offers, drawings, schemes and other technical information, we reserve ourselves the right of property and of design, not allowing that these should be facilitated to third parties without our previous written assent.

DICSA retains the property of the supplied merchandise until full payment of the agreed price. DICSA also retains the property of the Product's project, which in no circumstances shall be disclosed or sold to third parties.

THE ASSEMBLIES AT THE LOCATION (PLANT) OF THE CUSTOMER

The offers of the assemblies done for the customer, in his elected location of work, are considered as an estimate (approximate calculation), due to the particular and special characteristics that they can represent, not being able to give place, except final agreement between the parts, to final prices.

REPAIRMENT

The works of repair will not begin until written acceptance, on the part of the Customer, of the offer and of the conditions established in it. Supposing that the offer is not accepted by the Customer within one month, the expenses derived from the disassembly, storage, survey and freightage will be chargeable to the Customer. If the Customer requests the repair before accepting the offer, the assemblies will be carried out as soon as possible and, for his part, the Customer will have to accept the final cost of the repair.

In case of delivery of new products in exchange for the repair, if this one was out of guarantee, the Customer will have to accept the payment corresponding to it. The budgets of repair are always as estimation and should not be considered as final prices.

Condiciones de venta

General conditions of sale

En caso de entregarse productos nuevos a cambio de la reparación, si esta estuviera fuera de garantía el Cliente deberá aceptar el cargo correspondiente a la misma.

Los presupuestos de reparación siempre son orientativos y en ningún caso deben tomarse como precios finales.

PLAZOS DE ENTREGA

DICSA se reserva la facultad de rechazar un pedido en función de la disponibilidad de los productos. En este supuesto, lo comunicará al comprador con la mayor brevedad posible.

El plazo de entrega será acordado por las partes contractuales. Los plazos de entrega se calcularán desde la fecha de recepción de la confirmación del pedido, pudiendo DICSA proceder sin interrupción alguna. DICSA no será responsable de las demoras en el suministro de toda o parte de la mercancía en el caso de fuerza mayor, tal como catástrofes naturales, limitaciones legales, huelgas, etc., o cualquier otra causa fuera de nuestro control. En el caso de darse alguna de las razones anteriormente citadas, el periodo de entrega se hará extensible al mismo periodo de tiempo que dure la causa que haya motivado el retraso. Sin embargo, si el periodo excediera de seis meses, DICSA podrá cancelar la parte no enviada notificando previamente por escrito al comprador.

Procuramos con el mayor interés, cumplir los plazos de entrega que se indican en nuestras ofertas o en nuestras confirmaciones de pedido, si bien es materialmente imposible responder plenamente de dicho cumplimiento, por depender de otros proveedores y de inesperadas circunstancias totalmente ajenas a nuestro posible control.

De ahí que no se aceptarán sanciones por demora en la entrega prevista.

DERECHO DE PROPIEDAD

DICSA mantiene la propiedad de la mercancía hasta que el comprador realice el pago por completo de la misma.

Será responsabilidad del comprador tomar las medidas necesarias para conservar en buen estado la mercancía hasta que haya sido pagada, debiendo asegurarse a DICSA el cobro de la misma en caso de haber sido vendida a terceras personas por el comprador.

GARANTÍA

No se responderá de ninguna reclamación que no sea efectuada dentro de los 12 meses siguientes a la entrega de la mercancía, ni se aceptarán devoluciones sin autorización previa o pasados 15 días desde la entrega de la mercancía. En cualquier caso, toda devolución deberá ir acompañada de copia de nuestra autorización y, siempre que no sea por causas imputables a DICSA, conllevará un recargo mínimo del 20 % sobre el coste del material devuelto, corriendo todos los gastos a cargo del cliente.

En relación con los defectos que aparezcan en los productos suministrados, DICSA aceptará como única responsabilidad u obligación, abonar la pieza o piezas defectuosas siempre que la mercancía haya sido tratada adecuadamente y que los defectos surgidos sean debidos a defectos de material o fabricación.

La garantía comprende la reposición o reparación de los elementos defectuosos a realizar en nuestros talleres.

La garantía se entiende siempre con el material presumiblemente defectuoso depositado en nuestras instalaciones, con los gastos de transporte y riesgo a cargo del comprador.

Los consejos y asesoramiento dados antes y post cierre del contrato, se realizan con la mejor intención y según nuestros máximos conocimientos, no obstante DICSA no asume ninguna clase de responsabilidades a este respecto, ni responderá de los eventuales daños directos o indirectos que indistintamente, por quién, dónde y por qué puedan producirse.

DICSA no será responsable de ninguna consecuencia o ningún daño indirecto producido al Comprador o a terceros, incluyendo los daños de pérdida de oportunidades, negocio o ingresos.

DICSA garantiza exclusivamente sus materiales excluyendo cualquier responsabilidad por los efectos o perjuicios que estos puedan provocar en instalaciones, maquinarias o circuitos. En ningún caso se responsabilizará de los accidentes personales o materiales y pérdidas de producción.

Se excluye de la garantía las averías producidas por mal uso o deficiente instalación, averías provocadas por sometimiento de los equipos a esfuerzos anormales con fines experimentales, de ajuste o prueba. La total responsabilidad de DICSA por los daños causados, independientemente del tipo de acción o teoría de la responsabilidad, no excederá del importe de la obra, instalación o materiales que haya sido objeto de pedido a DICSA. Cualquier importe que supere dicha cantidad y que DICSA se vea obligada a soportar ya sea por decisión judicial, arbitral o similar, será repetida a la compradora hasta lograr indemnidad.

Se encuentran excluidos de esta garantía:

- El uso de instalaciones o servicios, que se aparten de los manuales de instrucción o especificaciones de DICSA.
- El uso inadecuado de instalaciones o negligencia del Comprador, sus Ayudantes o Agentes.
- Las partes suministradas por el Comprador.

DELIVERY TERMS

DICSA saves itself the right to reject an order depending on the availability of the products. In this supposition, DICSA will communicate it to the Customer as promptly as possible.

The delivery time has to be approved by the contractual parts. The delivery time will be calculated from the date of receipt of the confirmation of the order, when DICSA will be able to proceed without any interruption. DICSA will not be responsible for the delays in the supply of all or in part of the goods in case of major force, such as natural catastrophes, legal limitations, strikes, etc., or any other reason beyond our control. In case of any of the reasons previously mentioned, the period of delivery will be extensible to the same period of time that lasts the reason that has motivated the delay. Nevertheless, if the period exceeds six months, DICSA may cancel the part that couldn't be sent, by previously notifying the Customer in writing.

We do our best to respect the delivery times that are indicated in our offers or in our order confirmations, though it is materially impossible to answer completely for the above mentioned fulfillment, since we depend on other suppliers and on unexpected circumstances totally foreign to our possible control. Won't be accepted any sanctions for the delay in the foreseen delivery.

RIGHT OF PROPERTY

DICSA maintains the property of the materials (products) until the Customer makes the payment in full of the merchandise.

The Customer is responsible for taking the necessary actions to preserve in good condition the merchandise until it has been paid, must insure DICSA of the payment of the same one in case of having being sold to third persons by the Customer.

WARRANTY

We won't attend any claim done after the 12 months following the delivery of the merchandise. Returned material will not be allowed without previous authorization or when the time between the purchase and the request for return exceeds 15 days.

In any case, all returned merchandise will have to be accompanied by a copy of our authorization and, providing that it is not for reasons attributable to DICSA, will carry a minimal surcharge of 20 % on the cost of the returned material, all the expenses will be charged to the customer. Concerning the faults that appear in the supplied products, DICSA will only accept as unique responsibility or obligation, the paying of the product or defective products providing that the products (merchandise) have been treated adequately and that the arisen faults are due to faults of material or manufacture.

The warranty includes the replacement or repair of the defective elements in our workshops. The warranty is understood always in relation with the presumably defective material deposited in our warehouse, but the costs of transport and the risk being at the expense of the Customer. The advices given before and post closing of the contract, are made with the best intention and according to our know-how, nevertheless DICSA does not assume any category of responsibilities in this regard, nor will answer of the eventual direct or indirect damages that could take place indistinctly, no matter who, where and why they may take place.

DICSA will not be responsible for any consequence or indirect damages occurred to the Customer, and / or third Parties including but not limited to loss of opportunities, business and incomes.

DICSA guarantees exclusively its own materials, excluding any responsibility for the effects or damages that these could provoke in facilities, equipments or conductions. In no case will take responsibility for accidents related to individuals or materials or for losses in fabrication.

The warranty excludes the breakdowns produced by badly use or deficient installation, breakdowns provoked by overloading of the equipments for experimental purposes, either for adjustment or testing. DICSA's total responsibility for the caused damages, independently of the type of action or theory of the responsibility, will not exceed the amount of the work done, installation or materials that have been object of the order to DICSA.

Any amount that exceeds the above mentioned quantity, and any amount that DICSA will have to support either for judicial, arbitral or similar decision, will be transmitted to the Customer until obtaining indemnity.

Will be excluded from this warranty:

- *The use of facilities or services, which are different of those included in the manuals of instruction or in DICSA's specifications.*
- *The inadequate use of facilities or negligence of the Customer, his Assistants or Agents.*
- *The parts supplied by the Customer.*

FREIGHTAGES

By merchandise we always mean the one deposited in DICSA's warehouse, even in operations conditioned by the delivery at destination and the merchandise will always travel at the account and risk of the Customer, being at his charge, including the additional insurances that could be established and the special permissions it may need. According to what it is established in the article 18 of the Royal decree 782/1998 concerning wrapping and packaging mentioned in the 1st additional Disposition (Regulation) of the Law 11/1997, the person responsible for the delivery of the residues of the packaging and worn packages, for the correct environmental management, will be the final user.

Condiciones de venta

General conditions of sale

PORTES

La mercancía se entiende siempre depositada en el domicilio de DICSА, incluso en operaciones condicionadas a la entrega en destino y la mercancía siempre viajará por cuenta y riesgo del comprador, siendo a su cargo inclusive los seguros adicionales que pudieran establecerse y los permisos especiales a que hubiera lugar.

Según se establece en el artículo 18 del Real Decreto 782/1998 para los envases y embalajes acogidos a la Disposición adicional 1.ª de la Ley 11/1997, el responsable de la entrega de los residuos de los embalajes y envases usados, para su correcta gestión ambiental, será el usuario final.

ENVÍOS DE EMERGENCIA

Sea cual fuere el medio de transporte utilizado, avión, courier, régimen de equipajes, agencias especiales, mensajeros etc. Independientemente del importe de dicho servicio, el comprador correrá con todos los gastos extra, los de acarreos, de desplazamientos, y de comunicaciones que el servicio haya ocasionado, sin que en ningún caso este valor pueda ser inferior a 60 euros.

PEDIDOS ESPECIALES

Todo pedido de material especial, conllevará el pago anticipado del 50 % del importe del pedido, como condición indispensable para su aceptación. Dicho importe quedará siempre a favor de DICSА como indemnización en cualquier caso de anulación por parte del comprador, sin perjuicio de las reclamaciones que por Ley se puedan tener derecho.

VENTA MÍNIMA

La facturación mínima será de 50 € sea cual sea el importe del pedido.

PAGOS

Los pagos se realizarán como máximo y salvo acuerdo expreso entre las partes, a 60 días desde la fecha de la factura y previa recepción de los informes positivos de crédito. Si el comprador no efectuare el pago de cualquiera de los suministros a su vencimiento, DICSА está autorizado a suspender los envíos posteriores hasta que se realice dicho pago. Cualquier cargo bancario asociado con el pago de la mercancía, así como los gastos de devolución de efectos en caso de impago, serán por cuenta del comprador.

En caso de demora en el pago y sin perjuicio de otros derechos atribuidos al comprador por la legislación en vigor, el comprador abonará a DICSА un interés de demora del 2 % mensual desde la fecha de vencimiento de la factura.

COBRO DE LETRAS O RECIBOS DEVUELTOS O APLAZADOS

Serán a cargo del librado:

- Gastos de devolución.
- Intereses del 1 % mensual desde el día del vencimiento fallido hasta la fecha de cobro definitivo.
- Posible valor del timbre de nuevos documentos.
- Prima de seguro de crédito.

PAGOS COINCIDENTES EN VACACIONES

Si el cliente no pudiese atender los pagos que coincidiesen con periodos vacacionales, éstos se trasladarán al mismo día del mes anterior. En caso de existir días fijos de pago, el vencimiento se trasladará al día hábil de pago inmediatamente anterior.

USO DE SOFTWARE

En la medida en que el volumen de entrega incluye la puesta a disposición de software, el cliente tiene el derecho no exclusivo a usarla incluyendo la documentación adjunta. Se le cede el software para el uso en el objeto de entrega al cual va destinado. No se admite el uso de este software en otro sistema. La modificación, traducción o adaptación de código de objeto a código de origen así como la reproducción de software solamente se admite en la medida legalmente establecida. El cliente se compromete a no retirar las indicaciones del fabricante, especialmente indicaciones del Copyright sin el consentimiento previo de DICSА. Todos los demás derechos sobre el software y la documentación incluyendo las copias, corresponden a DICSА o al proveedor del software. No se admite la concesión de sublicencias.

DERECHO APLICABLE Y JURISDICCIÓN

Las relaciones jurídicas entre DICSА y el comprador están sujetas al derecho Español. El tribunal competente será el del domicilio de DICSА. Sin embargo, DICSА podrá optar por interponer las acciones legales correspondientes en el domicilio del comprador.

EMERGENCY DELIVERIES

No matter the type of the transportation used: by plane, courier, as baggage (luggage), special agencies, messengers etc; independently of the amount of the above mentioned service, the Customer will pay all the extra expenses, those of transportation, of shipping, and of communications that the service has caused; this value may not, under no circumstance, be lower than 60 euros.

SPECIAL ORDERS

Any order (request) of special material, will carry the anticipated payment of 50 % of the amount of the order (request), as an indispensable condition for its acceptance. The above mentioned amount will always be in favor of DICSА as compensation in case of cancellation on the part of the Customer, without prejudice of the claims at which they may have right by Law.

MINIMAL SALE

The minimal invoice will be of 50 €, no matter the amount of the order.

PAYMENTS

The payments have to be done, except express written agreement between the parts, in maximum 60 days from the date of the invoice and previous receipt of the positive reports of credit. If the Customer doesn't make the payment in time, for a part of the merchandise supplied, DICSА is authorized to suspend the posterior deliveries until the Customer executes the due payments. Any bank charges associated with the payment of the merchandise, as well as the expenses of return of it in case of non-payment, will be at the expense of the Customer. In case of delay in the payment and without prejudice of other rights attributed to the buyer for the legislation in effect, the Customer will pay to DICSА an interest of monthly delay of 2 % starting from the date when the invoice comes to its term.

UNPAID OR POST-PONED INVOICES

Will be at the expense of the Customer:

- The return expenses.
- Monthly interests of 1 %, from the day when the payment has come to its term and wasn't made, until the date of full payment.
- Possible amount (value) of the stamp of the new documents.
- The credit insurance.

COINCIDENTAL PAYMENTS IN VACATIONS

If the client could not attend to the payments that were coinciding with vacation periods, these will move to the same day of the previous month. In case there are fixed days of payment, the term of the invoice will move to the immediately previous working day of payment.

THE SOFTWARE USE

If the delivery includes the putting at the disposal of the Customer software, the Customer has the exclusive right to use it, including the attached documentation. The software is sent for the use in the object of delivery to which it is destined. It is forbidden the use of this software into any other system. The modification, translation or adjustment of the code of object to code of origin as well as the reproduction of software is only admitted into the legally established limits. The Customer promises not to withdraw the indications of the manufacturer, especially the indications of the Copyright, without DICSА's previous assent. All the other rights on the software and the documentation including the copies, they belong to DICSА or to the supplier of the software. The concession of sublicenses is not admitted.

GOVERNING LAW AND JURISDICTION

These General Conditions and any agreement between DICSА and the Customer shall be exclusively governed by Spanish laws. The exclusive jurisdiction on any dispute between the DICSА and the Customer shall be the courts of DICSА's domicile. Nevertheless, DICSА has also the right to bring legal action against the Customer before the courts of the place of business and/or residence of the Customer.



SALINAS

CAUCHOS Y POLIURETANOS

ISO 9001

BUREAU VERITAS
Certification



BARRIO BARRONDO, 12, POLÍGONO LANDETXE. 48480 ZARATAMO. BIZKAIA. ESPAÑA
TFNO.: (34) 946 712 505 - FAX: (34) 946 712 638 - EMAIL: salinas@productos-salinas.com
WEB: <http://www.productos-salinas.com>